

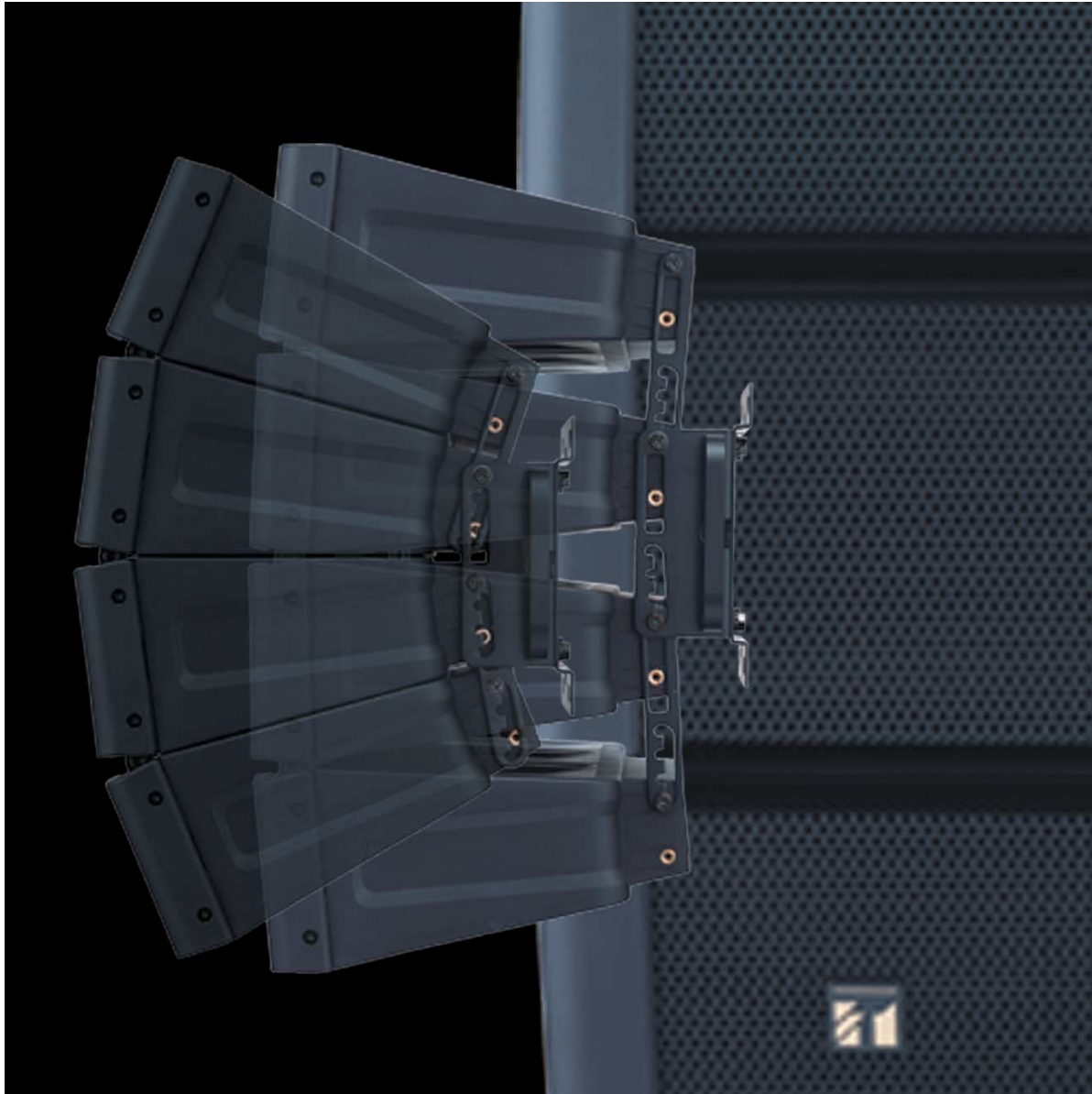

# HX-5 SERIES COMPACT ARRAY SPEAKER SYSTEM



***New innovations in sound reinforcement.***

# HX Series — Full area coverage

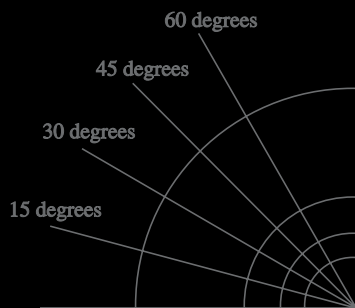

TOA's new HX-5 Series Speaker System fills an important need for versatile public address equipment that can provide high quality reinforcement for a wide range of venues. Available in black and white finishes to complement a venue's interior color scheme, the HX-5 Series is ideal for a wide range of medium size

venues of all different shapes that often pose problems for sound reinforcement. These include auditoriums, places of worship, banquet halls, community centres as well as dance halls, sports bars, shopping malls, boardrooms, gyms, health clubs and many others.



HX-5B /HX-5B-WP

## Design background

The HX-5 is an innovative modular speaker design that incorporates the best characteristics of the traditional, cumbersome woofer enclosure combined with a CD horn-loaded high frequency driver and the full-range compact speaker enclosure without the drawbacks associated with each type.

The traditional speaker system was able to provide well-controlled sound coverage but posed various difficulties for correct installation and also presented an old-fashioned appearance as well that impacts on the venue's appearance. The full-range compact speaker enclosure is easy to install, but the design's sound coverage is hard to control.

The HX-5 features remarkably easy to control coverage characteristics including problematic low frequencies and can be installed in a multitude of ways while maintaining a modern, unobtrusive appearance.

Directivity  
changeable  
speaker

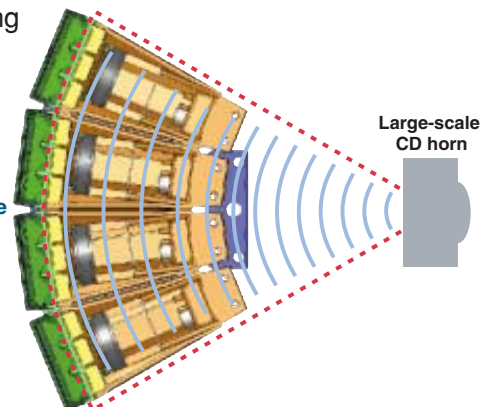

# and wider bandwidth sound.

## Adjustable sound dispersion

A system is configured by vertically stacking four speaker modules with a total driver complement of four woofers and 12 tweeters positioned along the baffle surface. This configuration allows the variable directivity control and low-frequency dispersion control comparable to using a large constant-directivity horn speaker. A choice of four directivity angles — 15, 30, 45 and 60 degrees can be employed as needed. For

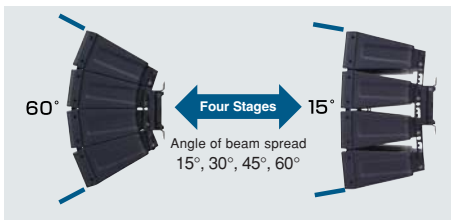

### When you arrange the plural

In multiple unit configurations, the HX-5 will be able to deliver greater low frequency output over its angle of dispersion.

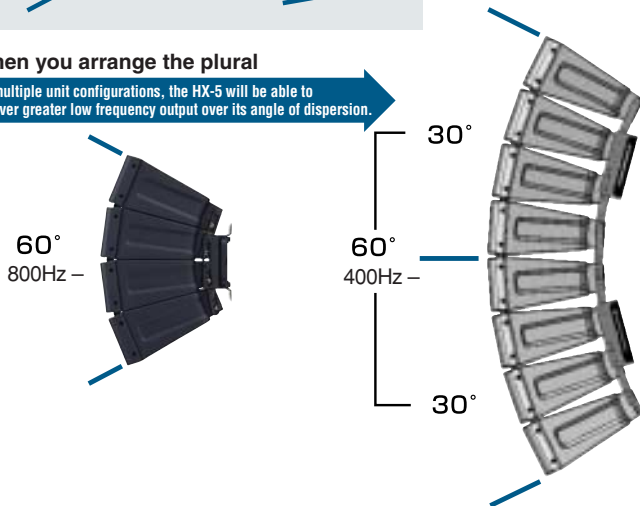

## Minimal reflective effects

Whether mounted on the wall or ceiling, the HX-5 is remarkably free from the comb filter and interference effects often encountered with other speaker designs. It can therefore produce more low frequency output even when mounted on the wall or ceiling.

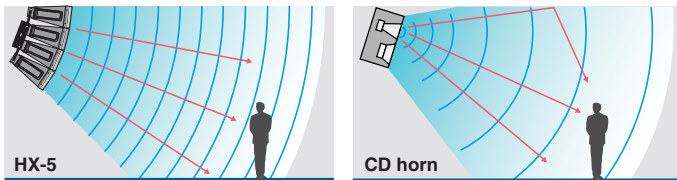

## Versatile mounting options

Compared to many other speaker designs, the HX-5 Series is remarkably easy to install in several ways. It can be hung easily with chains, strong wires and cables using the accessory brackets. There are also options for hanging with a pre-install frame by itself or configured with a subwoofer. There are also other options including ceiling and wall brackets as well as an adapter for use with a dedicated stand.

instance, a specific directivity angle, or each module can have its directivity independently set for a specific coverage requirement. When two or multiple modules are connected to configure an arc, they effectively function as an immense single speaker controlling directivity for considerably lower frequencies. As a result, public address functions demonstrate optimal intelligibility even in environments with long reverb times.



HX-5W-WP/HX-5W

## Transformer option

The HX-5 Series can also be used with a MT-200 matching transformer.



FB-120B

FB-120W

Subwoofer

# SPECIFICATIONS

	HX-5B	HX-5W	HX-5B-WP	HX-5W-WP
<b>Enclosure</b>	Bass-reflex type		Sealed type	
<b>Power Handling Capacity</b>	Continuous pink noise: 200W, Continuous program: 600W			
<b>Rated Impedance</b>	8Ω			
<b>Sensitivity (1W, 1m)</b>	96dB (60° mode), 97dB (45° mode), 98dB (30° mode), 99dB (15° mode)*			
<b>Frequency Response</b>	70 – 20,000Hz (–10dB) (60° mode), 75 – 20,000Hz (–10dB) (45° mode), 80 – 20,000Hz (–10dB) (30° mode), 85 – 20,000Hz (–10dB) (15° mode)		95 – 20,000Hz (–10dB) (60° mode), 100 – 20,000Hz (–10dB) (45° mode), 105 – 20,000Hz (–10dB) (30° mode), 110 – 20,000Hz (–10dB) (15° mode)	
<b>Crossover Frequency</b>	4kHz			
<b>Directivity Angle</b>	Horizontal: 100° (over 2000Hz) Vertical: 60° (over 800Hz), 45° (over 1.2kHz), 30° (over 1.6kHz), 15° (over 3.2kHz) variable			
<b>Speaker Component</b>	Low frequency: 12cm cone-type × 4 High frequency: Balanced dome-type × 12			
<b>Input Terminal</b>	Speakon NL4MP × 2 and M4 screw terminal		—	
<b>Speaker Cord</b>	—		2-core cabtyre cord with diameter of 6mm	
<b>Water Protection</b>	—		IPX4 (Install with the every speaker module downward)	
<b>Operating Temperature</b>	—		–15°C to +50°C	
<b>Finish</b>	Enclosure: Polypropylene, black	Enclosure: Polypropylene, white	Enclosure: Polypropylene, black	Enclosure: Polypropylene, white
<b>Dimensions</b>	408 (W) × 546 (H) × 342 (D)mm			
<b>Weight</b>	16kg			
<b>Accessory</b>	Hanging bracket × 2, Hex. wrench × 1			
<b>Option</b>	Matching transformer: MT-200 Speaker mounting bracket: HY-PF1B, HY-CW1B, HY-WM1B, HY-WM2B, HY-CN1B Speaker stand adapter: HY-ST1	Matching transformer: MT-200 Speaker mounting bracket: HY-PF1W, HY-CW1W, HY-WM1W, HY-WM2W, HY-CN1W Speaker stand adapter: HY-ST1	Matching transformer: MT-200 Speaker mounting bracket: HY-PF1WP, HY-CW1B-WP, HY-WM1WP, HY-WM2WP, HY-CN1W-WP	Matching transformer: MT-200 Speaker mounting bracket: HY-PF1WP, HY-CW1W-WP, HY-WM1WP, HY-WM2WP, HY-CN1W-WP

\* (Factory-preset: 60° mode)

	FB-120B	FB-120W
<b>Power Handling Capacity</b>	Continuous pink noise: 200W, Continuous program: 600W	
<b>Impedance</b>	8Ω	
<b>Sensitivity</b>	90dB (1W, 1m) at installation in free sound field 96dB (1W, 1m) at installation in 1/2 free sound field	
<b>Frequency Response</b>	40 – 1,200Hz (–10dB)	
<b>Speaker Component</b>	30cm cone-type	
<b>Input Terminal</b>	Speakon NL4MP × 2 and M4 screw terminal, distance between barriers:11mm	
<b>Finish</b>	Enclosure: Plywood Punched net: Steel plate, black, paint	Enclosure: Plywood Punched net: Steel plate, white, paint
<b>Dimensions</b>	408 (W) × 408 (H) × 450 (D)mm	
<b>Weight</b>	15kg	
<b>Option</b>	Speaker rigging frame: HY-PF1B	Speaker rigging frame: HY-PF1W

## Optional Accessories

**HY-PF1B Rigging Frame** for indoor use

**HY-CW1B Ceiling Mounting Bracket** for indoor use

**HY-WM1B Mounting Bracket** for indoor use

**HY-WM2B Mounting Bracket** for indoor use

**HY-CN1B/ HY-CN1W Extension Bracket** for indoor use

**HY-ST1 Speaker Stand Adapter**

**HY-PF1W Rigging Frame** for indoor use

**HY-CW1W Ceiling Mounting Bracket** for indoor use

**HY-WM1W Mounting Bracket** for indoor use

**HY-WM2W Mounting Bracket** for indoor use

**HY-PF1WP Rigging Frame** for outdoor use

**HY-CW1WP Ceiling Mounting Bracket** for outdoor use

**HY-WM1WP Mounting Bracket** for outdoor use

**HY-WM2WP Mounting Bracket** for outdoor use

**HY-CN1B-WP/ HY-CN1W-WP Extension Bracket** for outdoor use

**MT-200 Matching Transformer**

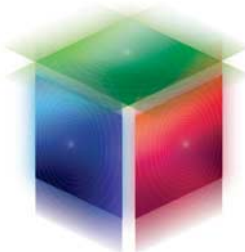

Human society with  
Sound & Communication

TOA Corporation  
www.toa.jp

Specifications are subject to change without notice.  
Printed in Japan (0611) 833-52-329-1B u