

# UNIVERSAL BATTERY CHARGER

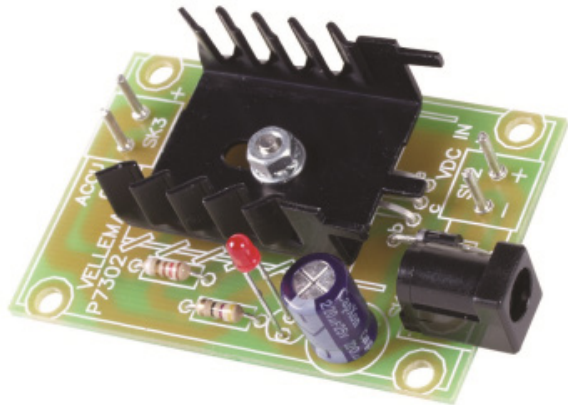

## K7302

Low cost solution for charging of  
both NiCd and NiMH batteries.

### Specifications:

- ☑ Charges Ni Cd or Ni MH batteries.
- ☑ Ideal for in car use.
- ☑ Transforms a mains adapter into a charger (adapter socket included).
- ☑ Charge cellular phone, toys, portables, video batteries ...
- ☑ Selectable charge current.
- ☑ LED charge indication.

### Features:

- Charge current ( $\pm 20\%$ ): 50mA, 100mA, 200mA, 300mA, 400mA. (selectable)
- Supply voltage: from 6.5VDC to 21VDC (depending on used battery)
- Supply current: same as charge current.
- Power supply polarity protected.
- LED function indication.
- Dimensions: 40 x 60 mm
- Fits in G403 type housing

## 1. Assembly (Skipping this can lead to troubles !)

Ok, so we have your attention. These hints will help you to make this project successful. Read them carefully.

### 1.1 Make sure you have the right tools:

- A good quality soldering iron (25-40W) with a small tip.
- Wipe it often on a wet sponge or cloth, to keep it clean; then apply solder to the tip, to give it a wet look. This is called 'thinning' and will protect the tip, and enables you to make good connections. When solder rolls off the tip, it needs cleaning.
- Thin raisin-core solder. Do not use any flux or grease.
- A diagonal cutter to trim excess wires. To avoid injury when cutting excess leads, hold the lead so they cannot fly towards the eyes.
- Needle nose pliers, for bending leads, or to hold components in place.
- Small blade and Phillips screwdrivers. A basic range is fine.

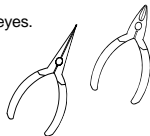

For some projects, a basic multi-meter is required, or might be handy

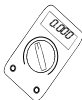

### 1.2 Assembly Hints :

- ⇒ Make sure the skill level matches your experience, to avoid disappointments.
- ⇒ Follow the instructions carefully. Read and understand the entire step before you perform each operation.
- ⇒ Perform the assembly in the correct order as stated in this manual
- ⇒ Position all parts on the PCB (Printed Circuit Board) as shown on the drawings.
- ⇒ Values on the circuit diagram are subject to changes, the values in this assembly guide are correct\*
- ⇒ Use the check-boxes to mark your progress.
- ⇒ Please read the included information on safety and customer service

\* Typographical inaccuracies excluded. Always look for possible last minute manual updates, indicated as 'NOTE' on a separate leaflet.

### 1.3 Soldering Hints :

1- Mount the component against the PCB surface and carefully solder the leads

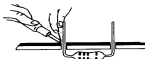

2- Make sure the solder joints are cone-shaped and shiny



3- Trim excess leads as close as possible to the solder joint



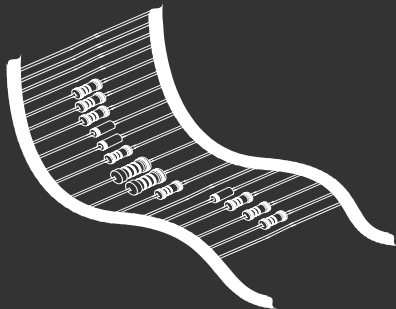

REMOVE THEM FROM THE TAPE ONE AT A TIME !

Included in  
this kit



## 2. RESISTOR

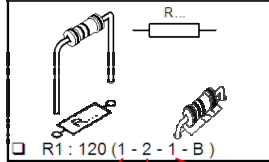

COLOUR	COLOUR NAME	1ST DIGIT/ STRIPE	2ND DIGIT/ STRIPE	3RD DIGIT/ STRIPE	MULTIPLIER STRIPE	TOLERANCE
Black	BLACK	0	0	0	x1	1%
Brown	BROWN	1	1	1	x10	
Red	RED	2	2	2	x100	
Orange	ORANGE	3	3	3	x1.000	
Yellow	YELLOW	4	4	4	x10.000	
Green	GREEN	5	5	5	x100.000	
Blue	BLUE	6	6	6	x1.000.000	

**DO NOT BLINDLY FOLLOW THE ORDER OF THE COMPONENTS ONTO THE TAPE.  
ALWAYS CHECK THEIR VALUE ON THE PARTS LIST!**

## Charging batteries

### Determining the charge current:

**Before building the kit**, one must determine how much current will be used to charge the battery or battery pack.

It is advisable to charge the battery with a current that is 10 times smaller than the battery capacity, and to charge it for about 15 hours. If you double the charge current, then you can charge the battery in half the time.

### **Example:**

A battery pack of 6V / 1000mAh can be charged with 100mA during 15 hours. If you want to charge faster, then a charge current of 200mA can be used for about 7 hours.

 **CAUTION:** The higher the charge current, the more critical the charge time must be checked. When faster charging is used, it is advisable to discharge the battery completely before charging.

Using a charge current of 1/10 of the capacity will expand the lifetime of the battery. The charge time can easily be doubled without damaging the battery.

**Determining the supply voltage :**

This table indicates the minimum and maximum voltages to supply the charger.

**Example:**

To charge a 6V battery a minimum supply voltage of 12V is needed, the maximum voltage is then 15V.

Battery Voltage	Supply voltage		Usable adapter type
	Min.	Max.	
1.2V	6.5V	10V	PS905
2.4V	7.5V	11V	PS905
3.6V	9.6V	12V	PS905
4.8V	10.5V	13V	PS1205
6V	12V	15V	PS1205
7.2V	13.2V	16V	PS1505
8.4V	14.5V	17V	PS1505
9.6V	15.6V	18V	PS1505
10.8V	16.8V	19V	/
12V	18V	21V	/

### 1. Diode. Watch the polarity !

D1 : 1N4007

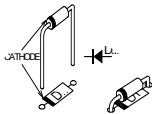

### 2. 1/2W Resistor

R1 : 120 (1 - 2 - 1 - B - 9).

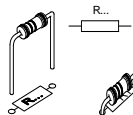

### 3. Resistor

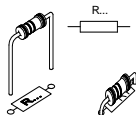

The value of resistor R2 determines the charge current:

R2

50mA	:	47	1/4W	(4 - 7 - 0 - B)
100mA	:	18	1/4W	(1 - 8 - 0 - B)
200mA	:	6,8	1/4W	(6 - 8 - B - B)
300mA	:	3,9	1/2W	(3 - 9 - B - B - 9)
400mA	:	2,7	1/2W	(2 - 7 - B - B - 9)

### 4. LED (check the polarity!)

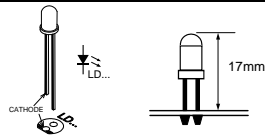

LD1 : 3mm low current RED

👉 **REMARK:** Depending on the used housing, the LED can be mounted at a higher position, to make it visible through a hole in the housing.

### 5. PCB pins

To connect the input and output wires via PCB tabs, mount pins at positions SK2 and SK3

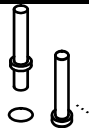

SK2 : +       SK3 : +

SK2 : -       SK3 : -

## 6. Electrolytic Capacitor. Watch the polarity !

□ C1 : 220 $\mu$ F

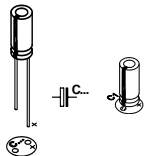

## 7. DC Jack

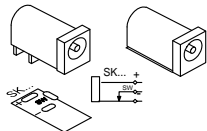

☞ Remark: even if the DC adapter jack is not used, it must be mounted, due to the internal switch.

□ SK1 : DJ-005

## 8. Transistor

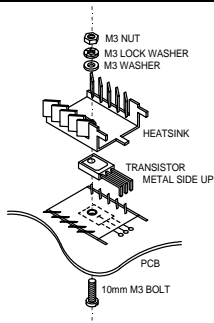

□ T1 : BD135

Mount the transistor together with the heatsink on the PCB, bend the leads as necessary. Take care that the metal back of the transistor touches the heatsink. Check that the leads of the transistor do not touch the heatsink.

## 9. Mounting in an housing

The PCB can easily be mounted into our housing type G403. Due to heat dissipation, it is advisable to make some 4mm ventilation holes into the housing. Holes for the adapter jack and wires will also be necessary.



## 10. Connection

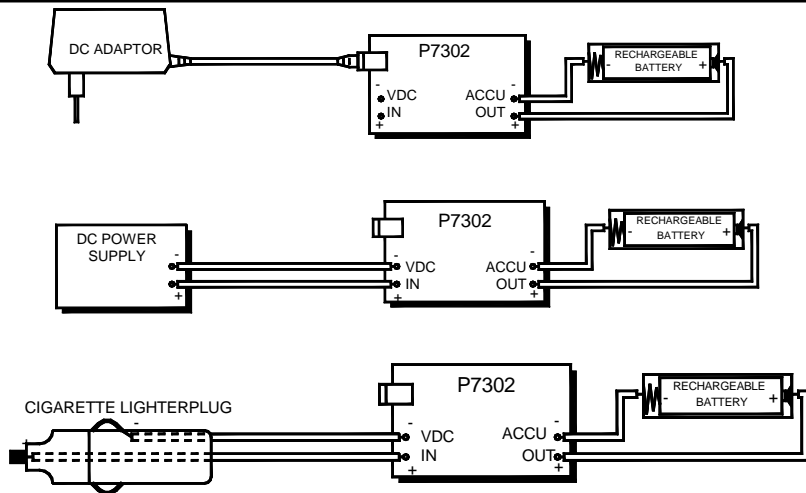

- Connecting the supply voltage and the battery.  
See table on page 6 for suitable supply voltage

## 11. Schematic diagram

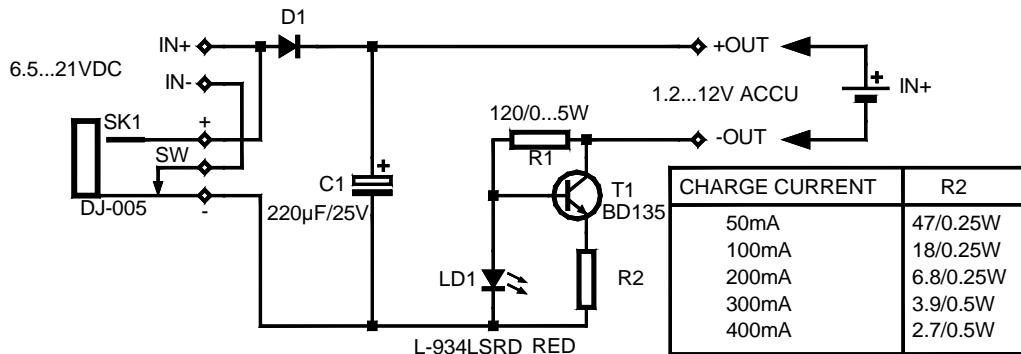

12. PCB

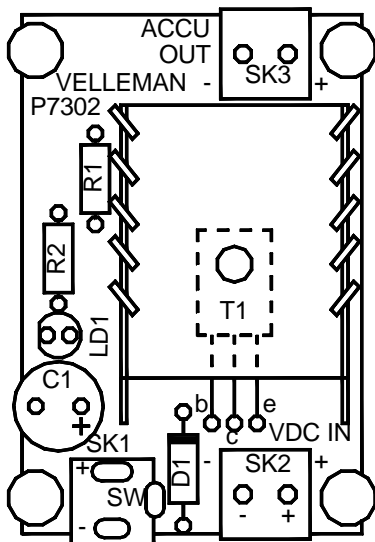

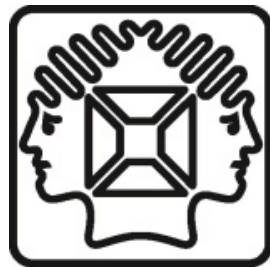

VELLEMAN NV  
Legen Heirweg 33, B-9890 GAVERE  
Belgium (Europe)

Modifications and typographical errors reserved - © Velleman nv.  
H7302IP'2 - 2014 (rev.1)

