

WEST PENN WIRE

Cable and Connector
Product and Installation Manual

WEST PENN WIRE

Product Manual
West Penn Wire
PM-2000-WP
10/11

Cable and Connector Product and Installation Manual

Table of Contents:

Miniature RGB Cables and Connectors	1
Crimp BNC for Miniature RGB	2
Compression BNC for Miniature RGB	3
SDI-Digital Coaxial Cables and Connectors	4
Crimp for RG59/U Plenum	5
BNC Crimp Connectors for RG59/U and RG6/U	6
Compression BNC for RG59/U Plenum	7
Compression RCA for RG59/U	8
CATV RG6/U Coaxial Cables and Connectors	9
Line Level Audio Cable and Connectors	10
Speaker Level Audio Cables and Connectors	11
LAN- Networking Cables and Connectors	12
RJ45 Plug Termination	13
RJ45 Jack Termination	14
Low Skew Cables	15
Media Control Cables (Cresnet and AXlink)	15
Reference Pictures- CN-BM74-19	A
Reference Pictures- CN-BNCP-RGB	B
Reference Pictures- CN-BM73-30	C
Reference- Compression Tools	D

WEST PENN WIRE

West Penn Wire- Product Manual

5 Wire RGB Most Popular Cable and Connectors

255CRGB is the standard 5 wire RGBHV cable utilized for TI video applications.

- 75 Ohm BNC Crimp Connector:
 - West Penn Wire: [CN-BM74-19](#)
 - Extron: [100-250-01](#)
- Tools: West Penn Wire
 - Strip Tool: [24-7371P](#) (T-Strip)
 - Crimp Tool: [TL-105](#) or [TL-803](#)

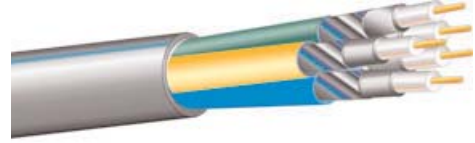

- 75 Ohm BNC Compression Connector:
 - [CN-BNCP-RGB](#)
- Tools:
 - Strip Tool: [24--7371P](#) (T-Strip)
 - Compression Tool: [TL-SNSA](#)

Products- Miniature High Resolution- 25 Awg. Solid

Miniature- 25 Awg. Solid Bare Copper- 100% Aluminum Foil + 95% Spiral Tinned Coverage

Bulk Cables: West Penn Wire

Non-Plenum

- [3CRGB](#) Non-Plenum - 3 Miniature Coaxial Cables- RGB
- [5CRGB](#) Non-Plenum - 5 Miniature Coaxial Cables- RGBHV
- [6CRGB2P](#) Non-Plenum - 6 Miniature Coaxial Cables RGBHV + Composite Video + 2 Pair (Audio)
- [6CRGB4P](#) Non-Plenum - 6 Miniature Coaxial Cables RGBHV + Composite Video + 4 Pair Cat 5E

Plenum

- [253CRGB](#) Plenum - 3 Miniature Coaxial Cables- RGB
- [255CRGB](#) Plenum - 5 Miniature Coaxial Cables- RGBHV
- [256CRGB2P](#) Plenum - 6 Miniature Coaxial Cables RGBHV + Composite Video + 2 Pair (Audio)

Features:

- *Miniature sized*
- *Optimum Electrical Characteristics*
- *1 Piece Compression RCA and BNC*
- *Flexible Plenum Design*
- *Custom Cable Assemblies available*
- *Designed for Digital Applications*

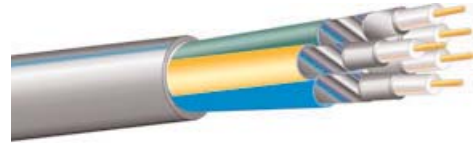

Connectors: West Penn Wire

- [CN-BNCP-RGB](#) Compression 75 Ohm BNC Connector
- [CN-BM74-19](#) Crimp 75 Ohm BNC Connector
- [CN-RCP-RGB](#) Compression RCA Connectors

All connectors are 75 ohm

Differences between 75 ohm and 50 ohm connectors

75 ohm: Dielectric inside connector body - Teflon

50 ohm: Dielectric to the face of the connector



Crimp BNC for Miniature RGB

CN-BM74-19 - 4 Piece BNC Crimp



WEST PENN WIRE

West Penn Wire- Product Manual

Crimp Termination- 5 Wire RGB- 255CRGB and 5CRGB

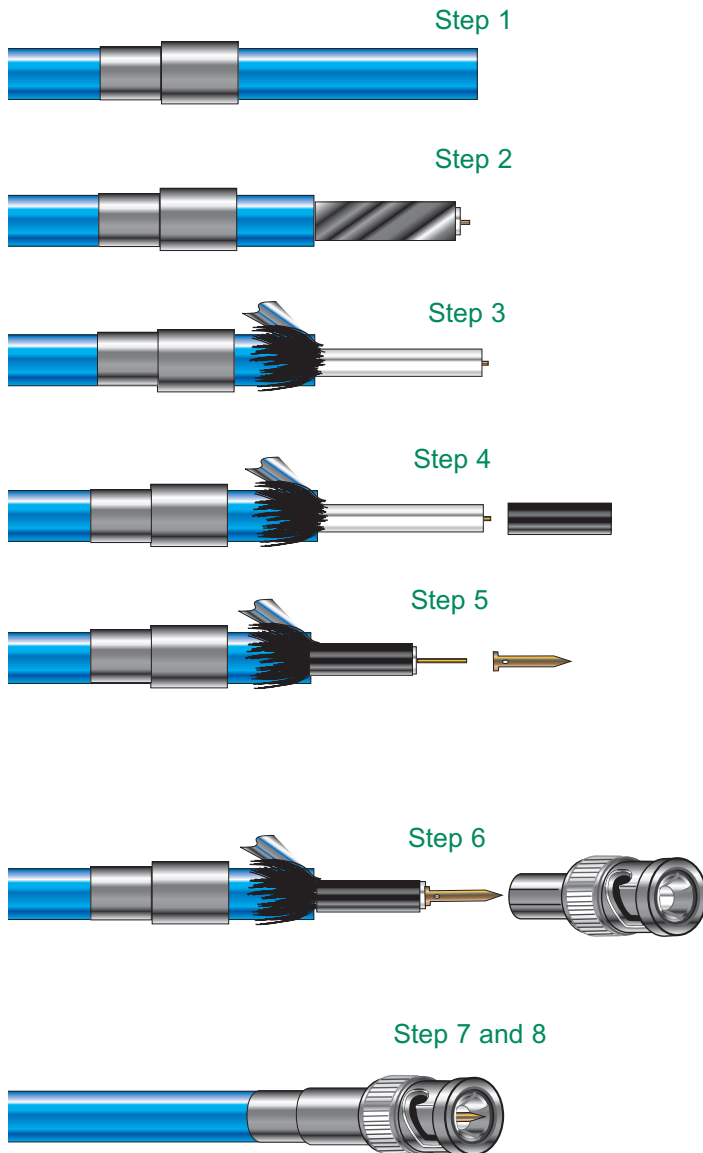

Stripping Pictures
See Reference Page. A

TL-KLEIN



Stripping of **255CRGB** for Crimp Connectors:

1. Feed Crimp Sleeve ferrule - small end first onto the cable jacket.
2. Strip Cable - using **TL-KLEIN** or hand held T-strips (wire strip tool)
 - Jacket- Approximately .500"
 - Leaving exposed braid and dielectric
3. Flair braid and shield back and trim.
 - Trim .250"
 - Tear foil off
4. Feed strengthening plastic sleeve over the dielectric.
 - Dielectric that is exposed needs to be trimmed flush with plastic sleeve.
 - Trim center conductor to 5/32" -.1563"
5. Feed center pin crimp sleeve over the center conductor, until it butts against the plastic sleeve. Crimp using .068" crimp die on **TL-105** or **TL-803**.
Note: if the crimp sleeve is not fitting snug against the plastic sleeve you will need to trim the center conductor.
6. Feed Connector body on to the cable.
 - Connector body will "Snap" into place when seated properly.
7. Flair exposed braid evenly over the connector body.
8. Feed Crimp Ferrule flush against the connector body.
 - Crimp using- .178" crimp die on **TL-105** or **TL-803**

TL-105 - Crimp Tool for Miniature (25 Awg.), MiniMax (25 Awg)

•Crimp Dies: .068" and .178"

TL-803- Crimp Tool for Miniature (25 Awg.), MiniMax (25 Awg) and RG59/U

• Crimp Dies- .065", .068", .178", .213", .255"

Compression BNC for Miniature RGB

CN-BNCP-RGB - Compression Connector



WEST PENN WIRE

West Penn Wire - Product Manual

Compression Termination- 5 Wire RGB- 255CRGB and 5CRGB



Step 1

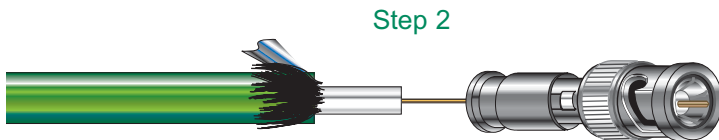

Step 2



Step 3

Stripping of 255CRGB for Compression Connectors:

1. Strip Cable - using TL-KLEIN or TL-CSST
TL-KLEIN

- Jacket- Approximately .500"
- Leaving exposed braid and dielectric
- Peel back braid and trim to .250"
- Strip .250" of Insulation (Dielectric)
- .250" of exposed center Conductor

TL-CSST

- Place cable into tool
- Turn tool clockwise 2-3 turns
- Turn tool counter-clockwise 2-3 turns
- Release the cable from the tool
- Peel stripped material from the cable

2. Push the connector onto the cable
• Window will help visually guide the cable into place.

NOTE: CN-BNCP-RGB

Internal cable guide is a necked down cylinder to ensure proper seating of the center conductor

3. Compress connector using a TL-SNSA

- For the Window Compression Connectors, set TL-SNSA tool at 2.

Stripping Pictures
See Reference Page. B

TL-KLEIN



TL-CSST
2 Blade Strip Tool

CN-BNCP-RGB
Set Tool to 2

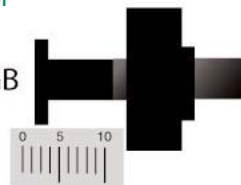

TL-SNSA



West Penn Wire- Product Manual

Products- SDI- Digital Coaxial Cables

25819 is the standard SDI- Digital Coaxial Cable

- 75 Ohm BNC Crimp Connector:
 - West Penn Wire: CN-BM73-30
 - Alternate- CN-BM74-32 - Plenum and Non-Plenum

Tools: West Penn Wire

- Strip Tool- TL-121
- Crimp Tool- TL-104 or TL-803

- 75 Ohm BNC Compression Connector:

- CN-FS59BNCPL4

Tools:

- Strip Tool- TL-CSST
- Compression Tool: TL-SNSA



Products- SDI- Digital Coaxial Cable Products

High Resolution- RG59/U and Super High Resolution RG6/U

Bulk Cables:

- 819 Non-Plenum - RG59/U SDI Coaxial Cables
- 25819 Plenum - RG59/U SDI Coaxial Cables
- 6350 Non-Plenum - RG6/U SDI Coaxial Cables
- 256350 Plenum - RG6/U SDI Coaxial Cables

Features:

- Optimum Electrical Characteristics
- 1 Piece Compression RCA and BNC
- Sweep Tested up to 3Ghz
- Custom Cable Assemblies available
- Designed for Digital Applications

Connectors: RG59/U SDI

- CN-FS59BNCPL4 Compression 75 Ohm BNC 25819
- CN-DB59BNCHD HD Compression 75 Ohm BNC 819
- CN-BM73-30 Crimp 75 Ohm BNC 25819
- CN-BM73-2 Crimp 75 Ohm BNC 819
- CN-BM74-32 Crimp 75 Ohm BNC 25819 and 819
- CN-FS59RCAPL4 Compression RCA for 819 and 25819

Connectors: RG6/U SDI

- CN-FS6BNCPL2 Compression 75 Ohm BNC 256350
- CN-DB6BNCHD HD Compression 75 Ohm BNC 6350
- CN-BM73-4 Crimp 75 Ohm BNC 256350
- CN-BM73-5 Crimp 75 Ohm BNC 6350



Crimp BNC for RG59/U Plenum
CN-BM73-30 or CN-BM74-32 Connectors



WEST PENN WIRE

West Penn Wire - Product Manual

Crimp Termination- Plenum SDI RG59/U - 25819 and RGBHV WP258195

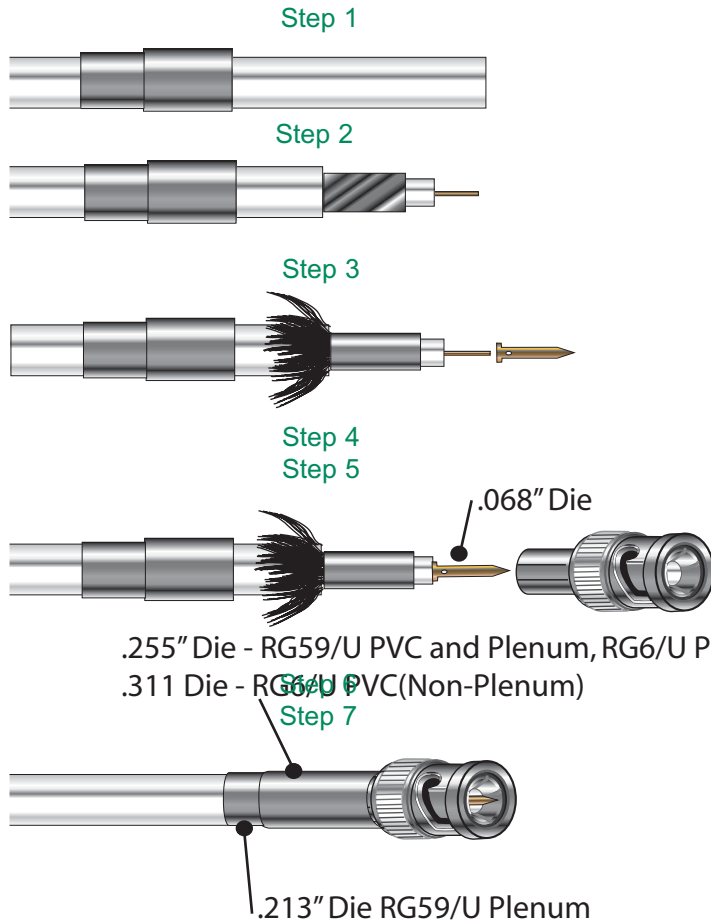

Stripping Pictures
 See Reference Page. C

Stripping of **25819** for Crimp Connectors:

1. Feed crimp sleeve ferrule onto cable jacket.
2. Strip cable - using **TL-121**.
3. Flair braid back over the jacket
 - Foil can stay bonded to the dielectric or peel the foil off the cable.
4. Feed center pin crimp sleeve over the center conductor, until it butts against the dielectric
 Crimp using **.068"** crimp die on **TL-104** or **TL-803**.
 Note: if the crimp sleeve is not fitting snug against the dielectric you will need to trim the center conductor.
5. Feed connector body on to the cable.
 - Connector body will "Snap" into place when seated properly.
6. Flair exposed braid evenly over the connector body.
7. Feed crimp ferrule over the connector body
 - Crimp using- **.213** on Neck down and **.255** crimp die on Ferrule Body- **TL-105** or **TL-803**.



TL-121
3 Blade Strip Tool



- TL-104** - Crimp Tool for RG59/U Plenum and Non Plenum
 - Crimp Dies: **.068"** and **.255"**
- TL-803**- Crimp Tool for Miniature (25 Awg.), MiniMax (25 Awg) and RG59/U
 - Crimp Dies- **.065"**, **.068"**, **.178"**, **.213"**, **.255"**

BNC Crimp Connectors RG59/U and RG6/U



WEST PENN WIRE

West Penn Wire - Product Manual

Crimp Termination- RG59/U and RG6/U SDI Plenum and Non-Plenum Cables

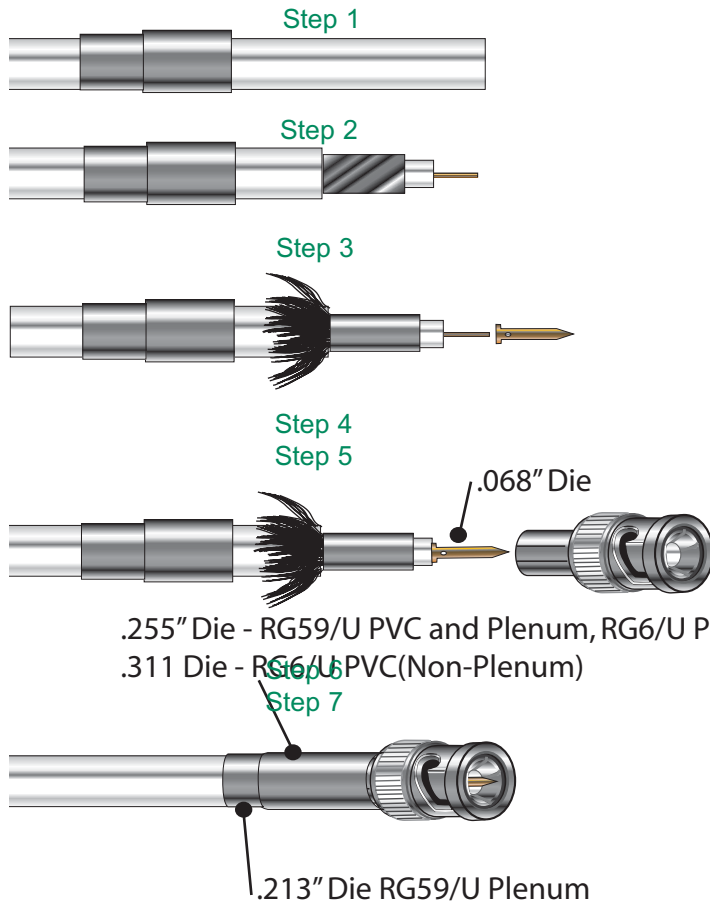

Stripping For RG59/U and RG6/U for Crimp Connectors: 75 ohm 3 piece.

1. Feed crimp sleeve ferrule onto cable jacket
2. Strip cable - using TL-121
3. Flair braid back over the jacket
 - Foil can stay bonded to the dielectric or peel the foil off the cable.
4. Feed center pin crimp sleeve over the center conductor - until it butts against the dielectric Crimp using appropriate center pin crimp die
 - Note: if the crimp sleeve is not fitting snug against the dielectric you will need to trim the center conductor.
5. Feed connector body on to the cable.
 - Connector body will "Snap" into place when seated properly.
6. Flair exposed braid evenly over the connector body
7. Feed crimp ferrule over the connector body
 - Crimp Ferrule using appropriate Crimp die.
 - RG59/U - .255" .213" neck down
 - RG6/U - .280"

Connectors: RG59/U SDI

Connector	Description	Strip Tool	Crimp Tool
CN-BM73-30	Crimp 75 Ohm BNC 25819	TL-121	TL-104 , TL-803, TL-107
CN-BM73-2	Crimp 75 Ohm BNC 819	TL-121	TL-104 , TL-803, TL-107
CN-BM74-32	Crimp 75 Ohm BNC 25819 and 819	TL-121	TL-104 , TL-803, TL-107

Connectors: RG6/U SDI

CN-BM73-4	Crimp 75 Ohm BNC 256350	TL-121	TL-107
CN-BM73-5	Crimp 75 Ohm BNC 6350	TL-121	TL-107

CRIMP TOOL DIFFERENCES:

- TL-105 - CABLES- MINIATURE RGB, AND MINIMAX 25 Awg. RACK CABLES
- TL-104 - CABLES- RG59/U NON-PLENUM AND PLENUM
- TL-803 - CABLES- MINIATURE RGB, MINIMAX 25 Awg., and RG59/U
- TL-107 - CABLES- RG59/U AND RG6/U

Compression BNC for RG59/U Plenum
CN-FS59BNCPL4 Compression Connector

WEST PENN WIRE

West Penn Wire - Product Manual

Compression Termination- RG59/U SDI Plenum 25819 and RGBHV WP258195

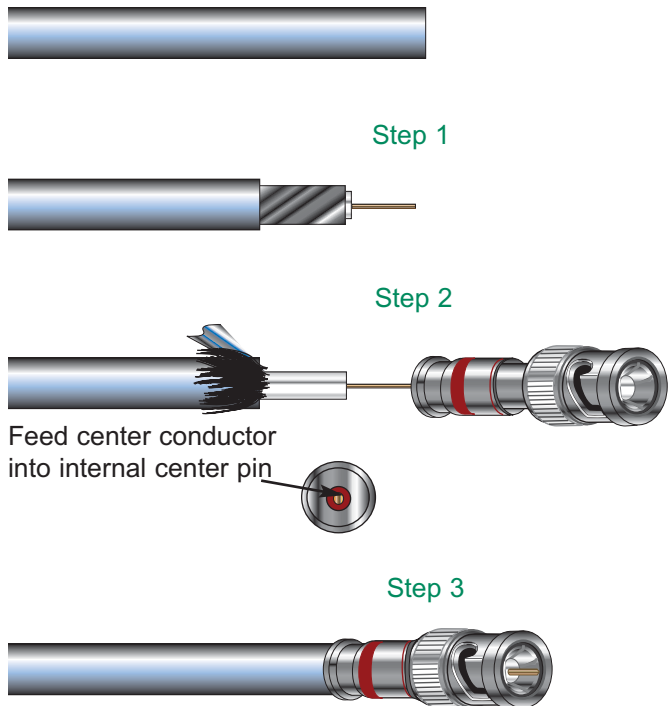

Stripping of **RG59/U Plenum** for Compression Connectors

1. Strip cable - using **TL-CCST**
TL-CSST
 - Place cable in tool rotate clockwise for 3 turns, counter-clockwise for 3 turns.
 - Release tool from the cable
 - extract stripped material from the cable
2. Feed center conductor into the internal center pin of the connector
Push the connector onto the cable
 - Push until center pin is seated properly in the connector body.

3. Compress connector using a **TL-SNSA**
 - For the **CN-FS59BNCPL4** set the tool at 9

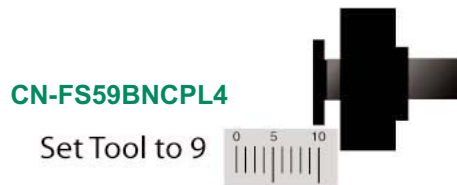

Compression RCA for RG59/U

CN-FS59RCAPL4 Compression Connector

WEST PENN WIRE

West Penn Wire - Product Manual

Compression Termination- RG59/U SDI Non-Plenum and Plenum

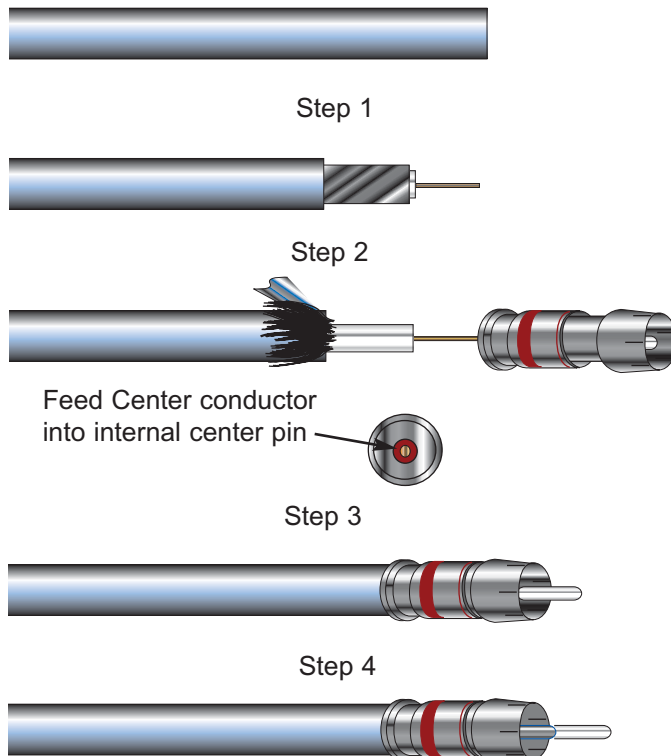

Stripping of **RG59/U Plenum** for Compression Connectors- **RCA**

1. Strip cable - using **TL-CCST** **TL-CSST**

- Place cable in tool rotate clockwise for 3 turns, counter-clockwise for 3 turns.
- Release tool from the cable
- extract stripped material from the cable

2. Feed center conductor into the internal center pin of the connector Push the connector onto the cable

- Push until center pin is seated properly in the connector body

3. Remove plastic pin guide.

4. Compress connector using a **TL-SNSA**

- For the **CN-FS59RCAPL4** set the tool at 1



TL-CSST
2 Blade Strip Tool

TL-SNSA



CN-FS59RCAPL4

Set Tool to 1



West Penn Wire - Product Manual

Crimp Termination- RG59/U and RG6/U SDI Plenum and Non-Plenum Cables

RG6/U CATV Cables

Bulk Cables:

Non-Plenum

- 841 Non-Plenum RG6/u CATV
- 25841 Plenum RG6/u CATV
- HQ841 Non-Plenum RG6/u Quad Shielded CATV
- 25Q841 Plenum RG6/u Quad Shielded CATV

Features:

- Optimum Electrical Characteristics
- Dual and Quad-Shield Cables
- 1 Piece Compression Connectors

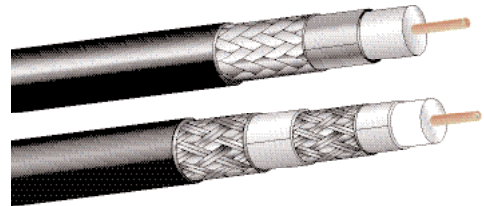

Connectors:

<i>Connector</i>	<i>Description</i>
CN-FCP-6	Compression "F" Type 841
CN-FCP-6QD	Compression "F" Type HQ841
CN-FS6PL2	Compression "F" Type 25841
CN-DB6PL2	Compression "F" Type 25Q841
CN-F56ALM	RG6/U Crimp "F" Type - 841
CN-F56ALX	RG6/U Quad Shield "F" Type HQ841
CN-F56TFE	RG6/U Plenum "F" Type 25841

<i>Strip Tool</i>	<i>Crimp Tool</i>
TL-CSST	TL-SNSA
TL-CSST	TL-SNSA
TL-CSST	TL-SNSA
TL-CSST	TL-CPLRBC
TL-59-6	TL-111
TL-59-6	TL-111
TL-59-6	TL-111



CN-FSPL2

West Penn Wire - Product Manual

Products- Line Level Audio Cable Products

Low Loss - Line Level Audio Cables

Bulk Cables:

454	Non-Plenum 1 Pair 22 Awg. Shielded
D25454	Plenum 1 Pair 22 Awg. Shielded
455	Non-Plenum 1 Pair 22 Awg. Shielded- Conformable Rack

Features:

- Optimum Electrical Characteristics
- Low Loss Dielectric
- Bonded Bi-foil - Easy strip
- 454- 12 Colors Available
- XLR, 3.5mm and 1/4" Connectors

Features of West Penn Wire Line Level Audio:

- Offered in 12 Colors:

Put the number in front of 454 to get your color: **10454 - Black Jacket**

1- Brown	2- Red	3- Orange	4- Yellow
5- Green	6- Blue	7- Violet	8- Gray
9- White	10- Black	11- Tan	12- Pink

- 454 Bonded foil shield for easy strip
- 455- Conformable Rack Cable



Connectors- Cable Mount

XLR:

CN-NC3MXB	3 Position XLR Male Bk/Gold
CN-NC3MXBAG	3 Position XLR Male Bk/Nickel
CN-NC3MX	3 Position XLR Male Nickel/Nickel
CN-NC3FXB	3 Position XLR Female Bk/Gold
CN-NC3FXBAG	3 Position XLR Female Bk/Nickel
CN-NC3FX	3 Position XLR Female Nickel/Nickel

3.5mm Audio Connectors:

CN-NYS231B	3.5mm Plug Bk/Nickel
CN-NYS231	3.5mm Plug Nickel/Nickel
CN-MX35M	3.5mm Term. Block Plug

Connectors- Panel Mount

XLR:

CN-NC3FDLB	3 Position XLR Female Panel Mount Bk/Gold
CN-NC3FDS1B	3 Position XLR Female Solderless- Screw Terminal
CN-NC3MDS1B	3 Position XLR Male Solderless- Screw Terminal

3.5mm Audio Connectors:

CN-35FFSP	3.5mm Panel Mount
CN-MX35	3.5mm Panel Mount Screw Terminal



CN-NC3FDS1B



CN-MX35

West Penn Wire - Product Manual

Products- Speaker Cable Products

Speaker Level Audio Cables

2 Conductor: Non-Plenum

- 224 Non-Plenum -2 Conductor 18 Awg. Unshielded
- 225 Non-Plenum -2 Conductor 16 Awg. Unshielded
- 226 Non-Plenum -2 Conductor 14 Awg. Unshielded

2 Conductor: Plenum

- 25224B Plenum -2 Conductor 18 Awg. Unshielded
- 25225B Plenum -2 Conductor 16 Awg. Unshielded
- 25226B Plenum -2 Conductor 14 Awg. Unshielded

Features:

- Electro Tough Pitch Copper
 - 99.96% Conductivity
- Jacket Colors Available
- Speakon Connectors



Connectors- Cable Mount

SPEAKON:

- CN-NL4FX 4 Pole- SPX Gray Back
- CN-NL4FX2 4 Pole- SPX Red Back
- CN-NL4FX4 4 Pole- SPX Yellow Back
- CN-NL4FX5 4 Pole- SPX Green Back
- CN-NL4FX9 4 Pole- SPX White
- CN-NL4FC 4 Pole- Standard



AWG	4Ω Speaker			8Ω Speaker			70V Speaker*		
	Power (%) /Loss(dB)								
	11% 0.5	21% 1	50% 3	11% 0.5	21% 1	50% 3	11% 0.5	21% 1	50% 3
8	180	370	1250	360	740	2495	9780	18000	61000
10	115	235	795	230	470	1585	5590	11495	38870
12	70	150	500	145	295	1000	3520	7245	24500
14	45	95	315	90	185	630	2220	4565	15430
16	30	60	195	55	115	395	1385	2855	9650
18	20	35	125	35	75	250	875	1795	6070
20	10	25	80	25	45	155	555	1140	3850
22	5	15	50	15	30	100	345	705	2390
24	5	10	30	10	20	60	220	450	1515

Cable Lengths are Measured in Feet.
(ft)

West Penn Wire - Product Manual

Products- Networking Cable Products

Network Cables

Category 5E Cables

4245 Non-Plenum -4 Pair 24 Awg. Category 5E
 254245 Plenum -4 Pair 24 Awg. Category 5E
 WP58762 Indoor/Outdoor CM- 4 Pair 24 Awg. Category 5E
 Colors add - BL(Blue), GY (Gray), WH (White), YE (Yellow),
 BK (Black), GN (Green), PK (Pink), OR (Orange).
 Order example: 4245-BL

Features:

- *Optimum Electrical Characteristics*
- *Jacket Colors Available*
- *RJ45 Plugs and Jacks Available*



Connectors

Plugs: EZ Plugs

32-EZP Cat 5E EZ Plugs
 TL-EZRJ45 Crimp Tool for EZ Plugs

Jacks: *Category 5E*

AX101315 Cat 5e Blue Jack
 AX101314 Cat 5e Green Jack
 AX101312 Cat 5e Red Jack
 AX101309 Cat 5e White Jack
 AX101308 Cat 5e Ivory Jack



Category 6 Cables

4246 Non-Plenum -4 Pair 23 Awg. Category 6
 254246 Plenum -4 Pair 23 Awg. Category 6
 Colors add - BL(Blue), GY (Gray), WH (White), YE (Yellow)
 4246-GY



Connectors

32-6EZP Cat 6 EZ Plugs
 TL-EZRJ45 Crimp Tool for EZ Plugs

Jacks: *Category 6*

AX101326 Cat 6 Blue Jack
 AX101325 Cat 6 Green Jack
 AX101323 Cat 6 Red Jack
 AX101320 Cat 6 White Jack

other colored jacks are available

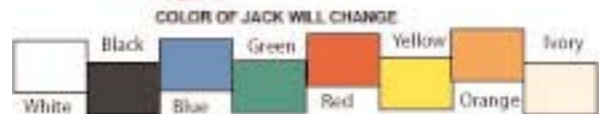

Category 6 F/UTP SHIELDED Cables

M58163 Non-Plenum -4 Pair 23 Awg. Category 6 F/UTP
 M58183 Plenum -4 Pair 23 Awg. Category 6
 Colors BLACK

Connectors

CN-111S90H34 Cat 6 EZ Plugs
 Jacks: *Category 6F/UTP*
 KJS458TL-C6C Cat 6 F/UTP Jack

Plug Termination- RJ45

32-EZP Cat 5E and 32-6EZP Cat 6

WEST PENN WIRE

West Penn Wire - Product Manual

Terminating EZ Plugs

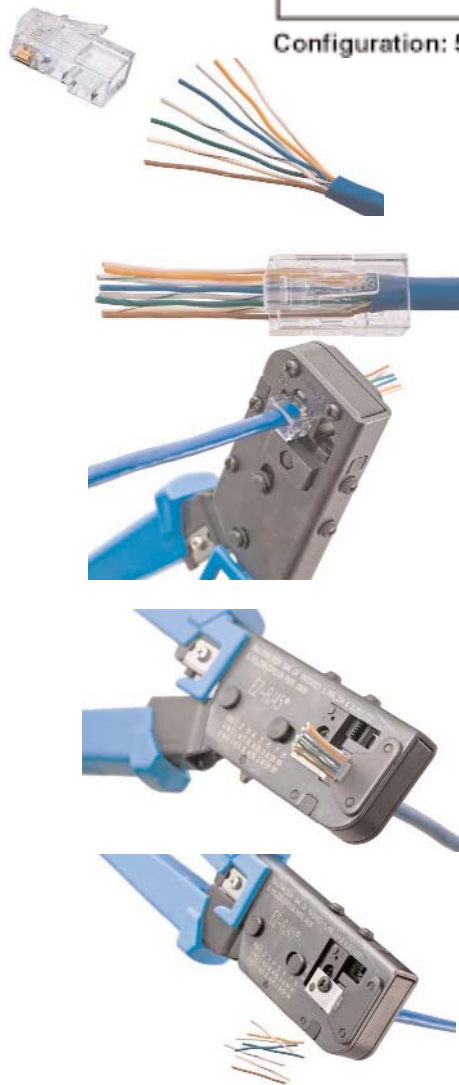
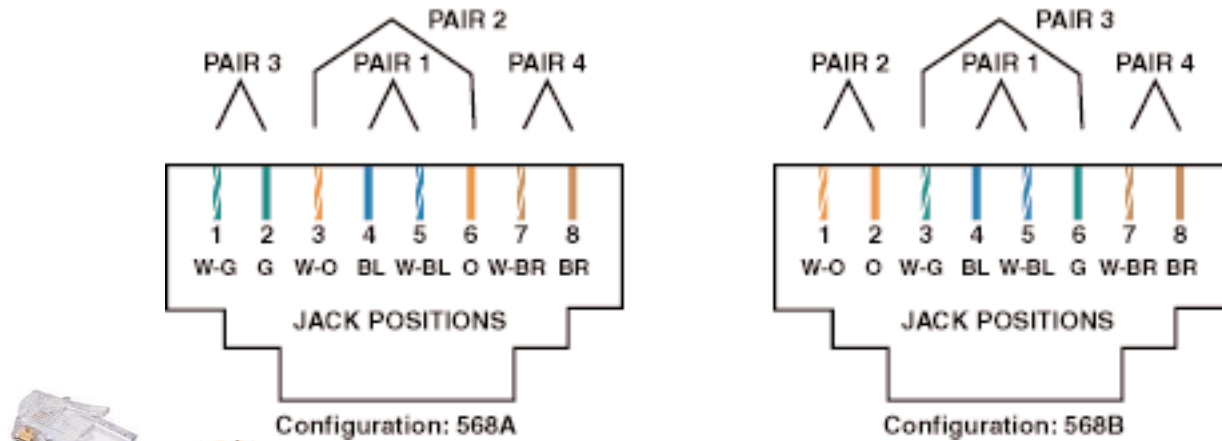

Striping Instructions:

1. Strip off 2.00" of jacket
2. Straighten and align wires to T568B or T568A - Trim Pairs
3. Insert wires into connector body
4. Pull tight to ensure jacket is .250" inside connector body
5. Verify wire location and orientation
6. Insert 32-EZP connector into crimp tool- TL-EZRJ45
7. Verify connector is completely seated and cable is fully inserted



8. Squeeze handle of TL-EZRJ45
9. Remove excess wires
10. Check jacket strain relief
11. Check that contacts are all engaged
12. Check that contact dividers are not damaged
13. Check to see if both ends of the cable have been terminated

West Penn Wire - Product Manual

Terminating Category 5E and Category 6 Jacks



Category Cable Jacks

IDC

All Jacks have IDC- Insulation Displacement Connections. These connections are made with a punch down tool. The Punch down tool displaces the insulation while the individual cable is being pressed between two metal clips. The metal clips make contact with the conductor.

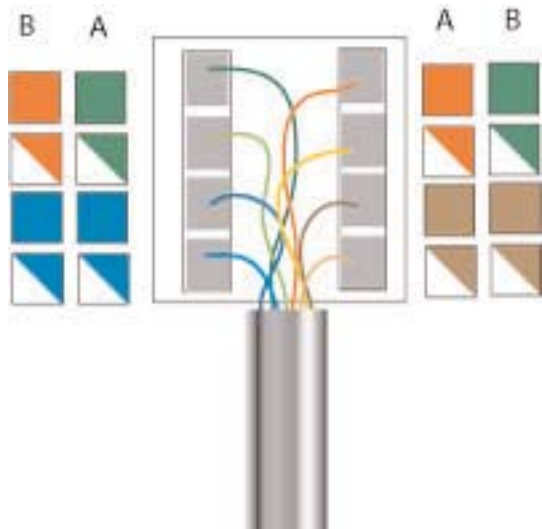

Terminating RJ45 Jacks

1. Strip cable .750"- 1.00"- Do not damage conductors
2. Fan out the individual Pairs. Do not untwist the individual pairs more than .500"
3. Place each wire into appropriate IDC slot color code
 - Choose between T568A or T568B
4. Punch down the individual wire - Do not punch down more than twice.
5. Place Protector Hood over the punched down wires

Cross-Compatibility:

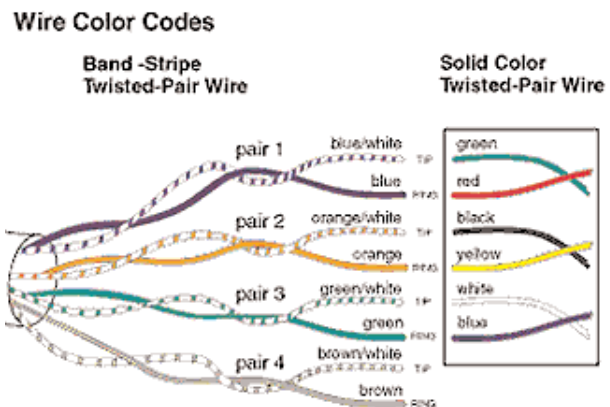

West Penn Wire- Product Manual

Products- Video RGB- UTP Cable Products

Low Skew- No- Skew UTP Cables

Bulk Cables:

M58813	Non-Plenum 4 Pair 24 Awg. Low Skew
M58814	Plenum 4 Pair 24 Awg. Low Skew
M58854	Indoor/Outdoor 4 Pair 24 Awg. Low Skew CM

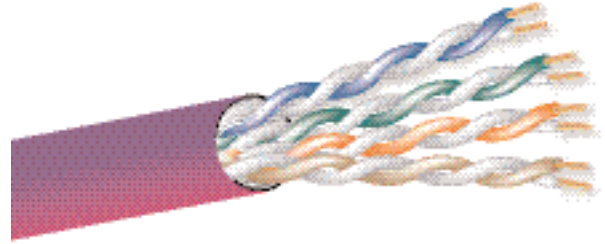

Difference between Low Skew UTP and Category Cables:

- **Category 5E or 6** - Each pair is twisted at different rates
 - This is done for electrical Cross-Talk between the pairs.
- **Low Skew UTP**- Each pair is twisted at the same rate
 - This is done because of the skew (delay propagation)

You can not use a Low Skew cable in a high speed networking system.

You can not use a Category Cable in a Video System

Connectors:

See Network Cables and Connectors

Media Control Cables

Products- Media Control Cables- Cresnet or AXlink

Cresnet- AXlink- Media Control Cables

Bulk Cables:

77350	Non-Plenum 1 Pair 22 Awg. Shielded + 2 Conductor 18 Awg.
D25350	Plenum 1 Pair 22 Awg. Shielded + 2 Conductor 18 Awg.

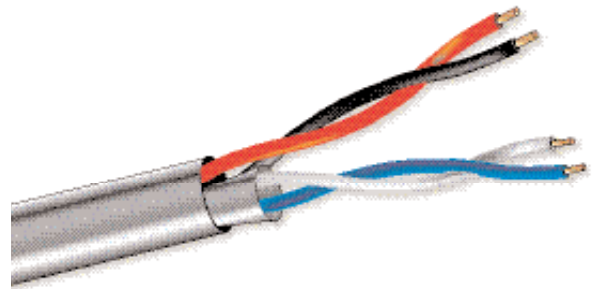

West Penn Wire - Product Manual

255CRGB - Reference Strip for CN-BM74-19 Crimp Connector

Feed crimp ferrule over the cable jacket- small end first.



Strip cable- approximately .500” using t-strippers [24-7371P](#) or [TL-825](#).

Trim braid/shield .250”



Slide Strengthening Sleeve over exposed dielectric - Black sleeve.



Trim insulation to expose center conductor.
Trim Center Conductor to .1563”



Feed center pin onto center conductor- Crimp die .068”
Using: [TL-105](#) or [TL-803](#).



Flair Braid evenly over the connector body.
Feed connector body on the cable until you hear a “Snap”.



Crimp ferrule- .178”
Using: [TL-105](#) or [TL-803](#).



A.

West Penn Wire- Product Manual

255CRGB - Reference Strip for CN-BNCP-RGB



Strip Cable- Jacket- .500"

.250" - Exposed Conductor
.250" - Exposed Dielectric/Shield
Using: [24-7371P](#) or [TL-CSST](#)



Flair Braid/Shield back over the Jacket. You may have to trim braid/shield to .250"



Feed connector over the cable. Compress connector onto cable. Using [TL-SNSA](#) or [TL-548G](#).

West Penn Wire - Product Manual

25819 - Reference Strip for CN-BM-73-30 Crimp Connector

Feed crimp ferrule and Strip
Using: **TL-121** strip tool



Flair back braid and either leave
foil or tear foil off



Crimp center pin onto the center
conductor- .068"
Using **TL-803** or **TL-107**



Feed connector body on the
cable until you hear a "Snap".



Feed crimp ferrule over the
connector body- Crimp- .255"
Using **TL-803** or **TL-107**



West Penn Wire- Product Manual

Compression Tools



TL-SNSA- Compression Tool

- Will do Miniature, MiniMax, RG59/U, and RG6/U
- Will do BNC, RCA, and “F”
- Window BNC- set tool at 2.
- F-Conn BNC- set tool at 9.



TL-548G- Compression Tool

- Will do Miniature, MiniMax, RG59/U, RG6/U, and RG11/U
- Will do BNC, RCA, and “F”
- Alternative for Window BNC connectors.
- Will NOT do F-Conn BNC connectors.



TL-CPLCCT-SLM- Compression Tool

- Will do Miniature, MiniMax, RG59/U, and RG6/U
- Will do BNC, RCA, and “F”
- Alternative for F-Conn BNC connectors.
- Will NOT do Window BNC connectors.