



O1V96i

DIGITAL MIXING CONSOLE

Owner's Manual

Keep This Manual For Future Reference.

Contents

PRECAUTIONS	5	Creating a Custom Layer by Combining Channels (User Assignable Layer)	44
Welcome	7	Using the Oscillator	45
Package Contents	7	Using the User Defined Keys	46
About the included discs	7	Using Operation Lock	47
About the included DAW software	7	Initializing	48
About the utility software	7	Troubleshooting	49
Firmware updates	8	Error messages	51
About this Owner’s Manual	8	Contents of the Reference Manual	54
Conventions Used in this Manual	8	Specifications	55
Control Surface & Rear Panel	9	General Spec	55
Control Surface	9	Libraries	60
Rear Panel	16	Analog Input Spec	61
Installing an Optional Card	18	Analog Output Specs	61
Operating Basics	19	Digital Input Spec	62
About the Display	19	Digital Output Spec	62
Selecting Display Pages	20	I/O SLOT Spec	63
Display Interface	20	MIDI/USB/WORD CLOCK I/O Spec	64
Selecting Layers	21	Dimensions	64
Selecting Channels	22	Options	65
Selecting Fader Modes	22	Rack Mounting the 01V96i Using RK1 Rack Mount Kit	65
Metering	23	Index	66
Connections and Setup	25	01V96i Block Diagram.....	End of Manual
Connections	25	01V96i Level Diagram.....	End of Manual
Wordclock Connections and Settings	27		
Input and Output Patching	29		
Tutorial	31		
Input and Output Patching	31		
Setting the Input Levels	32		
Pairing Channels	33		
Setting the Routing	33		
EQ’ing the Input Signals	35		
Using the EQ Library	36		
Compressing the Input Signals	37		
Using the Internal Effects	38		
Recording to DAW Software via the USB Port	39		
Adjusting the Monitor Levels from the DAW	41		
Using Scene Memories	42		
Changing the Channel Names	43		

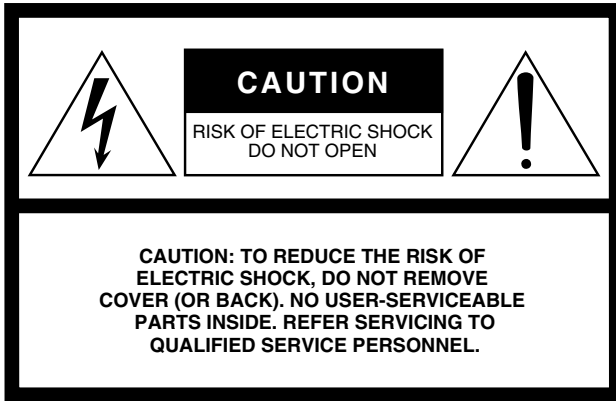

The above warning is located on the rear of the unit.

• Explanation of Graphical Symbols

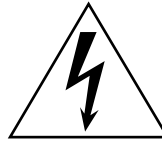

The lightning flash with arrowhead symbol within an equilateral triangle is intended to alert the user to the presence of uninsulated “dangerous voltage” within the product’s enclosure that may be of sufficient magnitude to constitute a risk of electric shock to persons.



The exclamation point within an equilateral triangle is intended to alert the user to the presence of important operating and maintenance (servicing) instructions in the literature accompanying the product.

IMPORTANT SAFETY INSTRUCTIONS

- 1 Read these instructions.
- 2 Keep these instructions.
- 3 Heed all warnings.
- 4 Follow all instructions.
- 5 Do not use this apparatus near water.
- 6 Clean only with dry cloth.
- 7 Do not block any ventilation openings. Install in accordance with the manufacturer’s instructions.
- 8 Do not install near any heat sources such as radiators, heat registers, stoves, or other apparatus (including amplifiers) that produce heat.
- 9 Do not defeat the safety purpose of the polarized or grounding-type plug. A polarized plug has two blades with one wider than the other. A grounding type plug has two blades and a third grounding prong. The wide blade or the third prong are provided for your safety. If the provided plug does not fit into your outlet, consult an electrician for replacement of the obsolete outlet.
- 10 Protect the power cord from being walked on or pinched particularly at plugs, convenience receptacles, and the point where they exit from the apparatus.
- 11 Only use attachments/accessories specified by the manufacturer.
- 12 Use only with the cart, stand, tripod, bracket, or table specified by the manufacturer, or sold with the apparatus. When a cart is used, use caution when moving the cart/apparatus combination to avoid injury from tip-over.
- 13 Unplug this apparatus during lightning storms or when unused for long periods of time.
- 14 Refer all servicing to qualified service personnel. Servicing is required when the apparatus has been damaged in any way, such as power-supply cord or plug is damaged, liquid has been spilled or objects have fallen into the apparatus, the apparatus has been exposed to rain or moisture, does not operate normally, or has been dropped.



WARNING

TO REDUCE THE RISK OF FIRE OR ELECTRIC SHOCK, DO NOT EXPOSE THIS APPARATUS TO RAIN OR MOISTURE.

FCC INFORMATION (U.S.A.)

1. IMPORTANT NOTICE: DO NOT MODIFY THIS UNIT!

This product, when installed as indicated in the instructions contained in this manual, meets FCC requirements. Modifications not expressly approved by Yamaha may void your authority, granted by the FCC, to use the product.

2. IMPORTANT: When connecting this product to accessories and/or another product use only high quality shielded cables. Cable/s supplied with this product **MUST** be used. Follow all installation instructions. Failure to follow instructions could void your FCC authorization to use this product in the USA.

3. NOTE: This product has been tested and found to comply with the requirements listed in FCC Regulations, Part 15 for Class "B" digital devices. Compliance with these requirements provides a reasonable level of assurance that your use of this product in a residential environment will not result in harmful interference with other electronic devices. This equipment generates/uses radio frequencies and, if not installed and used according to the instructions found in the users manual, may cause interference harmful to the operation of other electronic devices. Compliance with FCC regulations does

not guarantee that interference will not occur in all installations. If this product is found to be the source of interference, which can be determined by turning the unit "OFF" and "ON", please try to eliminate the problem by using one of the following measures:

Relocate either this product or the device that is being affected by the interference.

Utilize power outlets that are on different branch (circuit breaker or fuse) circuits or install AC line filter/s.

In the case of radio or TV interference, relocate/reorient the antenna. If the antenna lead-in is 300 ohm ribbon lead, change the lead-in to co-axial type cable.

If these corrective measures do not produce satisfactory results, please contact the local retailer authorized to distribute this type of product. If you can not locate the appropriate retailer, please contact Yamaha Corporation of America, Electronic Service Division, 6600 Orangethorpe Ave, Buena Park, CA90620

The above statements apply **ONLY** to those products distributed by Yamaha Corporation of America or its subsidiaries.

* This applies only to products distributed by YAMAHA CORPORATION OF AMERICA.

(class B)

ADVARSEL!

Lithiumbatteri—Eksplodingsfare ved fejlagtig håndtering. Udskiftning må kun ske med batteri af samme fabrikat og type. Levér det brugte batteri tilbage til leverandoren.

VARNING

Explosionsfara vid felaktigt batteribyte. Använd samma batterityp eller en ekvivalent typ som rekommenderas av apparattillverkaren. Kassera använt batteri enligt fabrikantens instruktion.

VAROITUS

Paristo voi räjähtää, jos se on virheellisesti asennettu. Vaihda paristo ainoastaan laitevalmistajan suosittelemaan tyyppiin. Hävitä käytetty paristo valmistajan ohjeiden mukaisesti.

(lithium caution)

NEDERLAND / THE NETHERLANDS

- Dit apparaat bevat een lithium batterij voor geheugen back-up.
- This apparatus contains a lithium battery for memory back-up.
- Raadpleeg uw leverancier over de verwijdering van de batterij op het moment dat u het apparaat aan het einde van de levensduur of gelieve dan contact op te nemen met de vertegenwoordiging van Yamaha in uw land.
- For the removal of the battery at the moment of the disposal at the end of life please consult your retailer or Yamaha representative office in your country.
- Gooi de batterij niet weg, maar lever hem in als KCA.
- Do not throw away the battery. Instead, hand it in as small chemical waste.

(lithium disposal)

This product contains a battery that contains perchlorate material. Perchlorate Material—special handling may apply, See www.dtsc.ca.gov/hazardouswaste/perchlorate.

* This applies only to products distributed by YAMAHA CORPORATION OF AMERICA.

(Perchlorate)

This product contains a high intensity lamp that contains a small amount of mercury. Disposal of this material may be regulated due to environmental considerations. For disposal information in the United States, refer to the Electronic Industries Alliance web site: www.eiae.org

* This applies only to products distributed by YAMAHA CORPORATION OF AMERICA.

(mercury)

COMPLIANCE INFORMATION STATEMENT (DECLARATION OF CONFORMITY PROCEDURE)

Responsible Party : Yamaha Corporation of America
Address : 6600 Orangethorpe Ave., Buena Park, Calif.
90620
Telephone : 714-522-9011
Type of Equipment : Digital Mixing Console
Model Name : 01V96i

This device complies with Part 15 of the FCC Rules.

Operation is subject to the following two conditions:

- 1) this device may not cause harmful interference, and
- 2) this device must accept any interference received including interference that may cause undesired operation.

See user manual instructions if interference to radio reception is suspected.

* This applies only to products distributed by YAMAHA CORPORATION OF AMERICA.

(FCC DoC)

IMPORTANT NOTICE FOR THE UNITED KINGDOM

Connecting the Plug and Cord

WARNING: THIS APPARATUS MUST BE EARTHED
IMPORTANT. The wires in this mains lead are coloured in accordance with the following code:

GREEN-AND-YELLOW : EARTH
BLUE : NEUTRAL
BROWN : LIVE

As the colours of the wires in the mains lead of this apparatus may not correspond with the coloured markings identifying the terminals in your plug proceed as follows:

The wire which is coloured GREEN-and-YELLOW must be connected to the terminal in the plug which is marked by the letter E or by the safety earth symbol  or colored GREEN or GREEN-and-YELLOW.

The wire which is coloured BLUE must be connected to the terminal which is marked with the letter N or coloured BLACK.

The wire which is coloured BROWN must be connected to the terminal which is marked with the letter L or coloured RED.

(3 wires)

PRECAUTIONS

PLEASE READ CAREFULLY BEFORE PROCEEDING

* Please keep this manual in a safe place for future reference.



WARNING

Always follow the basic precautions listed below to avoid the possibility of serious injury or even death from electrical shock, short-circuiting, damages, fire or other hazards. These precautions include, but are not limited to, the following:

Power supply/Power cord

- Do not place the power cord near heat sources such as heaters or radiators, and do not excessively bend or otherwise damage the cord, place heavy objects on it, or place it in a position where anyone could walk on, trip over, or roll anything over it.
- Only use the voltage specified as correct for the device. The required voltage is printed on the name plate of the device.
- Use only the supplied power cord/plug.
If you intend to use the device in an area other than in the one you purchased, the included power cord may not be compatible. Please check with your Yamaha dealer.
- Check the electric plug periodically and remove any dirt or dust which may have accumulated on it.
- Be sure to connect to an appropriate outlet with a protective grounding connection. Improper grounding can result in electrical shock.

Do not open

- This device contains no user-serviceable parts. Do not open the device or attempt to disassemble the internal parts or modify them in any way. If it should appear to be malfunctioning, discontinue use immediately and have it inspected by qualified Yamaha service personnel.

Water warning

- Do not expose the device to rain, use it near water or in damp or wet conditions, or place on it any containers (such as vases, bottles or glasses) containing liquids which might spill into any openings. If any liquid such as water seeps into the device, turn off the power immediately and unplug the power cord from the AC outlet. Then have the device inspected by qualified Yamaha service personnel.
- Never insert or remove an electric plug with wet hands.

Fire warning

- Do not put burning items, such as candles, on the unit. A burning item may fall over and cause a fire.

If you notice any abnormality

- When one of the following problems occur, immediately turn off the power switch and disconnect the electric plug from the outlet. Then have the device inspected by Yamaha service personnel.
 - The power cord or plug becomes frayed or damaged.
 - It emits unusual smells or smoke.
 - Some object has been dropped into the instrument.
 - There is a sudden loss of sound during use of the device.
- If this device should be dropped or damaged, immediately turn off the power switch, disconnect the electric plug from the outlet, and have the device inspected by qualified Yamaha service personnel.



CAUTION

Always follow the basic precautions listed below to avoid the possibility of physical injury to you or others, or damage to the device or other property. These precautions include, but are not limited to, the following:

Power supply/Power cord

- When removing the electric plug from the device or an outlet, always hold the plug itself and not the cord. Pulling by the cord can damage it.
- Remove the electric plug from the outlet when the device is not to be used for extended periods of time, or during electrical storms.

Location

- Do not place the device in an unstable position where it might accidentally fall over.
- Do not block the vents. This device has ventilation holes at the rear and sides to prevent the internal temperature from becoming too high. In particular, do not place the device on its side or upside down. Inadequate ventilation can result in overheating, possibly causing damage to the device(s), or even fire.
- If mounting this device in an EIA-standard rack, leave the back of the rack open, and keep the rack least 10 cm from the wall. If you mount this device in a rack together with a device that tends to generate heat, such as a power amp, take precautions to prevent heat from building up inside this device, for example by leaving space between the devices and by installing ventilation panels.

- Do not hold the bottom of the device when transporting or moving it. In doing so, you may pinch your hands under the device, and result in injury.
- Do not press the rear panel of the device against the wall. Doing so may cause the plug to come in contact with the wall and detach from the power cord, resulting in short circuiting, malfunction, or even fire.
- Do not place the device in a location where it may come into contact with corrosive gases or salt air. Doing so may result in malfunction.
- Before moving the device, remove all connected cables.
- When setting up the device, make sure that the AC outlet you are using is easily accessible. If some trouble or malfunction occurs, immediately turn off the power switch and disconnect the plug from the outlet. Even when the power switch is turned off, electricity is still flowing to the product at the minimum level. When you are not using the product for a long time, make sure to unplug the power cord from the wall AC outlet.

Connections

- Before connecting the device to other devices, turn off the power for all devices. Before turning the power on or off for all devices, set all volume levels to minimum.

Maintenance

- Remove the power plug from the AC outlet when cleaning the device.

Notice

Please observe the following precautions to prevent this device from malfunction or damage, and to avoid loss of data.

Precautions for care and handling

- Do not use this device near another electrical product such as a television, radio, stereo, or portable phone. Doing so may cause noise to be heard from this device or from the television or radio.
- Do not use this device in locations exposed to direct sunlight (such as the interior of a vehicle during the daytime), in locations of extremely high temperature such as near a stove, in locations of extremely low temperature, or in locations of excessive dust or heavy vibration. Doing so may cause the panel of this device to deform, cause malfunctions in the internal components, or cause operation to become unstable.
- Do not place vinyl, plastic, or rubber items on this device. Doing so may cause the panel to be discolored or disfigured.

Backup battery

- This device has a built-in backup battery. When you unplug the power cord from the AC outlet, the internal data is retained. However, if the backup battery fully discharges, this data will be lost. If the backup battery is running low, when you turn on the device the display indicates "WARNING Low Battery!." In this case, immediately save the data to an external media using MIDI Bulk Dump, then have qualified Yamaha service personnel replace the backup battery.

Handling caution

- Do not insert your fingers or hands in any gaps or openings on the device (vents, etc.).
- Avoid inserting or dropping foreign objects (paper, plastic, metal, etc.) into any gaps or openings on the device (vents, etc.) If this happens, turn off the power immediately and unplug the power cord from the AC outlet. Then have the device inspected by qualified Yamaha service personnel.
- Do not rest your weight on the device or place heavy objects on it, and avoid use excessive force on the buttons, switches or connectors.
- Do not use the headphones for a long period of time at a high or uncomfortable volume level, since this can cause permanent hearing loss. If you experience any hearing loss or ringing in the ears, consult a physician.

Information

- * The illustrations and screen displays as shown in this Owner's Manual are for instructional purposes only, and may be different from the ones on your device.
- * The company names and product names in this Owner's Manual are the trademarks or registered trademarks of their respective companies.

Yamaha cannot be held responsible for damage caused by improper use or modifications to the device, or data that is lost or destroyed.

Always turn the power off when the device is not in use.

The performance of components with moving contacts, such as switches, volume controls, and connectors, deteriorates over time. Consult qualified Yamaha service personnel about replacing defective components.

Information for Users on Collection and Disposal of Old Equipment



This symbol on the products, packaging, and/or accompanying documents means that used electrical and electronic products should not be mixed with general household waste.

For proper treatment, recovery and recycling of old products, please take them to applicable collection points, in accordance with your national legislation and the Directives 2002/96/EC.

By disposing of these products correctly, you will help to save valuable resources and prevent any potential negative effects on human health and the environment which could otherwise arise from inappropriate waste handling.

For more information about collection and recycling of old products, please contact your local municipality, your waste disposal service or the point of sale where you purchased the items.

[For business users in the European Union]

If you wish to discard electrical and electronic equipment, please contact your dealer or supplier for further information.

[Information on Disposal in other Countries outside the European Union]

This symbol is only valid in the European Union. If you wish to discard these items, please contact your local authorities or dealer and ask for the correct method of disposal.

(weee_eu)

Welcome

Thank you for choosing the Yamaha 01V96i Digital Mixing Console.

The compact 01V96i Digital Console features 24-bit/96 kHz digital audio processing without compromise, as well as 40-channel simultaneous mixing. The 01V96i covers a broad range of needs and applications including multi-track recording, 2-channel mix-down, and surround sound production.

Package Contents

- Power cord
- Owner's manual (this document)
- Reference manual CD-ROM × 1 disc
- DVD-ROM × 1 disc (included DAW software)

About the included discs

Note:

- Copyright of the included software is the property of Steinberg Media Technologies GmbH.
- Unauthorized duplication or modification of the included software and owner's manuals in whole or in part is forbidden.
- The manufacturer accepts no responsibility for any damages, either direct or consequential, that may result from the use of the included software and owner's manuals.
- The included disc is not an audio disc. Do not use it in a conventional audio player.

About the included DAW software

Yamaha Corporation provides no support for the included DAW software. Refer to the Steinberg website for any inquiries regarding the included software. The Steinberg website provides product-related support information, downloads of the latest updates, and a FAQ.

<http://www.steinberg.net/>

About the utility software

The provided utility software allows you to use the 01V96i connected with your computer.

■ Yamaha Steinberg USB Driver

This is driver software for connecting the 01V96i to your computer. Installing it in your computer will allow audio/MIDI communication to occur.

■ 01V96i Editor

This is software that allows you to make settings for the 01V96i console from your computer. It also allows you to back up the settings of the console, and to create set-ups even when the physical console is not available.

01V96i Editor runs within the platform software "Studio Manager Version 2."

■ Studio Manager Version 2

This is software that centrally manages multiple editors. 01V96i Editor also runs within this software. It allows you to save or recall settings for multiple devices simultaneously.

These software can be downloaded from the Yamaha Pro Audio website.

<http://www.yamahaproaudio.com/>

For details on installation and setup, refer to the above website and to the installation guide that was included with the program you downloaded.

Firmware updates

This product is designed to allow the internal firmware to be updated in order to improve performance, add functionality, or fix problems. Firmware updates are performed with the product connected to a computer, so you must first install the “Yamaha Steinberg USB Driver” in your computer.

Firmware updating is performed using update software. You can download the update software from the following website.

<http://www.yamahaproaudio.com/>

For details on the update procedure and settings, refer to the firmware update guide provided on the website.

About this Owner’s Manual

■ Owner’s manual (this document)

The owner’s manual describes the names and functions of items on the panels, and explains basic operation.

■ Reference manual (PDF format / on the included CD-ROM)

This explains details of the functionality, the effect parameters, and MIDI-related functions.

Using the PDF manual

The reference manual is provided as a PDF-format electronic file that you can view on your computer. By using “Adobe® Reader®” to view this file on your computer, you’ll be able to rapidly search for terms, print only the pages you require, or click a link to access a relevant section. In particular, searching for terms and clicking links are conveniences available only in an electronic file, and we hope you take advantage of these possibilities.

The latest version of Adobe Reader can be downloaded from the following website.

<http://www.adobe.com/>

Conventions Used in this Manual

The 01V96i features two types of buttons: physical buttons that you can press (e.g., ENTER and DISPLAY) and buttons that appear on the display pages. References to physical buttons are enclosed in square brackets, for example, “press the [ENTER] button.”

References to display page buttons are not emphasized, for example, “move the cursor to the ON button.”

You can select display pages by using the [DISPLAY] buttons or the Left Tab Scroll, Right Tab Scroll, and F1–4 buttons below the display. In order to simplify explanations, the procedures reference only the [DISPLAY] button method.

See “Selecting Display Pages” on page 20 for details on all the ways in which you can select pages.

Control Surface & Rear Panel

Control Surface

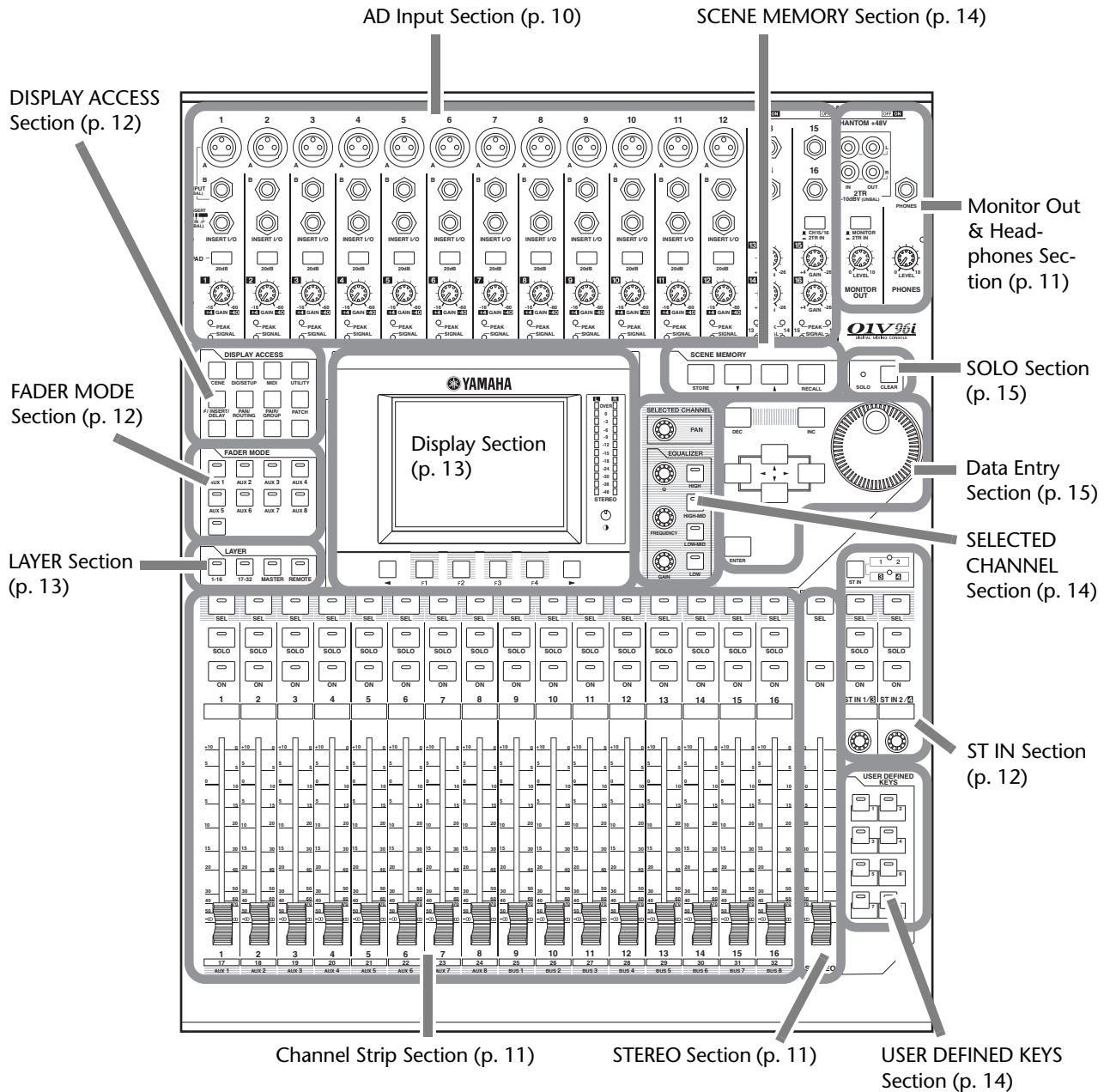

Note: Screw holes for attaching a cover are located at both sides of the AD input section of the 01V96i. (Size M3, horizontal spacing 417 mm, vertical spacing 36 mm.) You may wish to fabricate your own cover and attach it to the front panel to prevent the controls from being operated inadvertently. Yamaha does not sell such a cover. If you fabricate and attach your own cover, make sure that the mounting screws do not extend more than 10 mm into the front panel. You will need to allow approximately 15–20 mm between the top panel and the cover in order to clear the control knobs and buttons.

AD Input Section

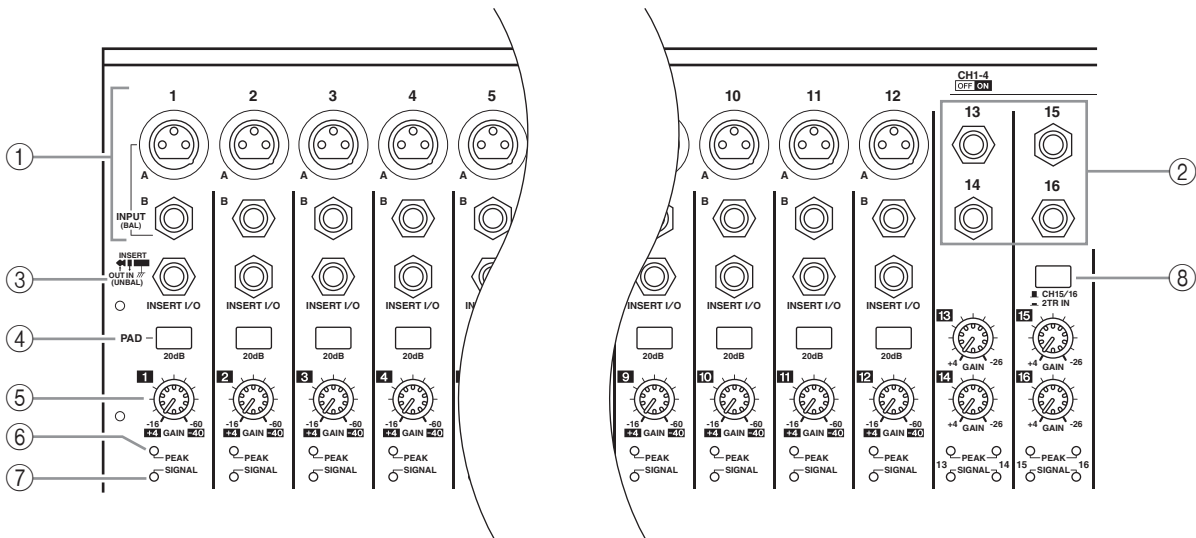

① INPUT connectors A/B

INPUT A connectors are balanced XLR-3-31-type connectors that accept line-level and microphone signals. Each of the phantom [+48V] switches on the rear panel turns on or off the +48V phantom power feed to the corresponding input. INPUT B connectors are balanced TRS phone-type connectors that accept line-level and microphone signals. The nominal signal level of both types of connectors ranges from -60 dB to +4 dB. Phantom power is not supplied to these connectors.

If you connect cables to INPUT A and INPUT B connectors of the same number, only the signal from INPUT B is effective.

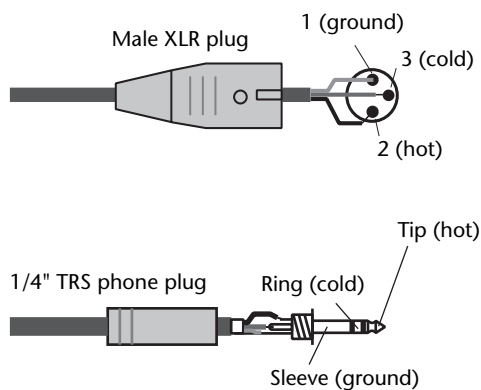

② INPUT connectors 13–16

These balanced TRS phone-type connectors accept line-level signals. The nominal signal level ranges from -26 dB to +4 dB. INPUT 15 & 16 connectors are available only when the AD 15/16 button is turned off.

③ INSERT I/O connectors

These unbalanced TRS phone-type connectors are used for channel insert ins and outs. Use a split

cable to insert an external effects processor to AD input channels.

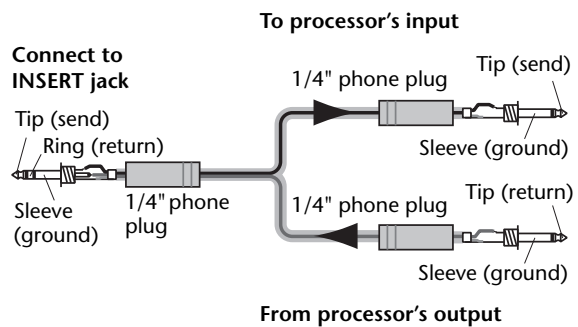

④ PAD switches

These switches turn on or off the 20 dB pad (attenuator) for each AD Input.

⑤ GAIN controls

These controls adjust input sensitivity for each AD Input. Input sensitivity is -16 dB to -60 dB when the Pad is off, and +4 dB to -40 dB when the Pad is on.

⑥ PEAK indicators

These indicators light up when the input signal level is 3 dB below clipping. Adjust the Pad switch and GAIN control so that the indicator rarely lights up at signal peak.

⑦ SIGNAL indicators

These indicators light up when the input signal level exceeds -34 dB.

⑧ AD15/16 selector

This button selects AD Input Channel 15 and 16 signals. When the button is turned on (pushed in), the 2TR IN signals (page 17) are selected. When the button is turned off (raised), the INPUT 15 and 16 signals are selected.

Monitor Out & Headphones Section

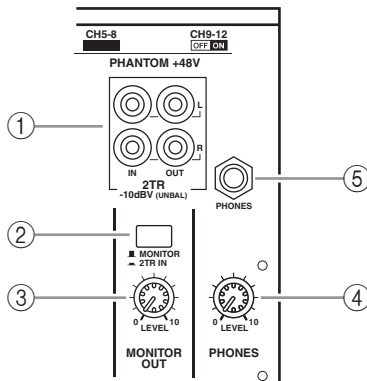

① 2TR IN/OUT connectors

These unbalanced RCA phono connectors input and output line-level signals, and are typically used to connect an external recorder.

When the AD15/16 selector in the AD Input section (⑧) is turned on (pushed in), the signals input at the 2TR IN connectors are routed to AD Input Channels 15 and 16. When the Monitor Source selector (②) is turned on (pushed in), you can monitor the 2TR IN signals from the MONITOR OUT connectors.

The 2TR OUT signals are always the same as the STEREO OUT signals.

② Monitor Source selector

This button selects the signals output from the MONITOR OUT connectors on the rear panel. When this button is turned on (pushed in), you can monitor the signals input from the 2TR IN connectors. When the button is turned off (raised), you can monitor the Stereo Out signals or soloed channel signals.

③ MONITOR LEVEL control

This control adjusts the monitoring level of the signals output from the MONITOR OUT connectors.

④ PHONES LEVEL control

This control sets the level of the PHONES.

⑤ PHONES jack

You can connect a set of stereo headphones to this stereo phone jack. The signals output from the MONITOR OUT connectors are also output from this jack.

Channel Strip Section

① [SEL] buttons

These buttons enable you to select desired channels. The [SEL] button indicator for the currently-selected channel lights up. The channel selected by each [SEL] button depends on the layer selected in the LAYER section (see page 13).

These buttons also allow you to create or cancel channel pairs, and add channels to (or remove them from) Fader, Mute, EQ, and Compressor groups.

② [SOLO] buttons

These buttons solo the selected channels. The [SOLO] button indicator of the currently-soloed channel lights up.

③ [ON] buttons

These buttons turn the selected channels on or off. The [ON] button indicators for On channels light up.

④ Channel faders

Depending on the button selected in the FADER MODE section (see page 12), these faders adjust the selected channel input levels or the Bus Out or Aux Out levels.

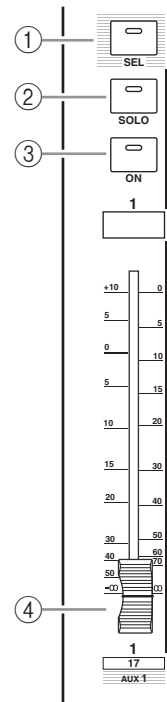

STEREO Section

① [SEL] button

Selects the Stereo Out.

② [ON] button

Turns the Stereo Out on or off.

③ [STEREO] fader

This 100mm motorized fader adjusts the final output level of the Stereo Out.

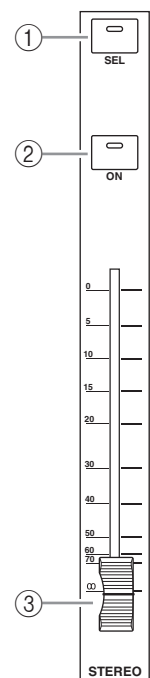

ST IN Section

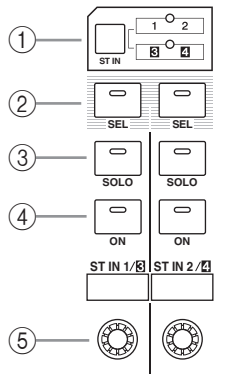

① [ST IN] button

This button selects an ST IN channel pair (ST IN Channels 1 & 2 or 3 & 4) which you can control using the buttons and controls in the ST IN section. The indicators to the right of the button indicate the available ST IN channels.

② [SEL] buttons

These buttons select the ST IN channel you want to control.

③ [SOLO] buttons

These buttons solo the selected ST IN channels.

④ [ON] buttons

These buttons turn the ST IN channels on or off.

⑤ Level controls

These controls adjust the ST IN channel levels.

FADER MODE Section

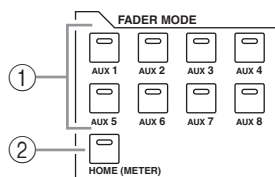

① [AUX 1]–[AUX 8] buttons

These buttons enable you to select the Aux Send you wish to control. Pressing one of these buttons switches the Fader mode (see page 22), and displays the corresponding Aux page. (The selected button's indicator lights up.)

You can now adjust the send level of signals routed from Input Channels to the corresponding Aux buses by using the faders.

② [HOME] button

This button recalls Meter pages that display Input Channel levels or Output Channel (Bus Out, Aux Out, Stereo Out) levels (see page 23).

DISPLAY ACCESS Section

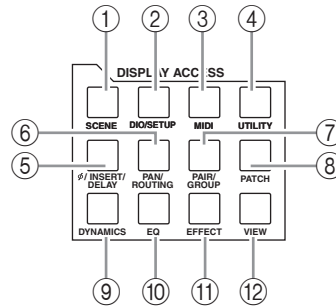

① [SCENE] button

This button displays a Scene page, enabling you to store and recall Scenes.

② [DIO/SETUP] button

This button displays a DIO/Setup page, enabling you to set up the 01V96i, including digital input and output setup and remote control setup.

③ [MIDI] button

This button displays a MIDI page, enabling you to make MIDI settings.

④ [UTILITY] button

This button displays a Utility page, enabling you to use the internal oscillators and view information about installed optional cards.

⑤ [∅ /INSERT/DELAY] button

This button displays a ∅ /INS/DLY page, enabling you to switch the signal phase, set the signal to be inserted, or set the delay parameters.

⑥ [PAN/ROUTING] button

This button displays a Pan/Route page, enabling you to select a Bus to which the selected channel signal is routed, adjust the selected channel pan settings, adjust the level of signals routed from Buses 1–8 to the Stereo Bus, and adjust the stereo or surround pan settings.

⑦ [PAIR/GROUP] button

This button displays a Pair/Group page, enabling you to create or cancel channel pairs and group multiple channel faders or [ON] buttons.

⑧ [PATCH] button

This button displays a Patch page, enabling you to patch input signals and Bus Out signals to Input channels, or patch signals to the desired output connectors.

⑨ [DYNAMICS] button

This button displays a Dynamics page, enabling you to control channel gates and compressors.

⑩ **[EQ] button**

This button displays an EQ page, enabling you to set the equalizer and attenuator of the selected channel.

⑪ **[EFFECT] button**

This button displays an Effect page, enabling you to edit the internal effects processors and use optional plug-in cards.

⑫ **[VIEW] button**

This button displays a View page, enabling you to view and set mix parameters for a specific channel.

LAYER Section

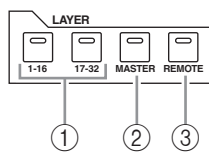
① **[1-16]/[17-32] buttons**

These buttons select an Input Channel layer as the layer controlled in the Channel Strip section. When the [1-16] button is turned on, you can control Channels 1-16. When the [17-32] button is turned on, you can control Channels 17-32. (See page 21 for more information on the Input Channel layers.)

② **[MASTER] button**

This button selects the Master Layer as the layer controlled in the Channel Strip section. You can use this layer to control Bus Outs and AUX Sends. (See page 21 for more information on the Master layer.)

③ **[REMOTE] button**

This button selects the Remote Layer as the layer controlled in the Channel Strip section. You can use this layer to control external MIDI devices or computer-based DAWs.

Tip: The ST IN section is not affected by the layer settings.

Display Section

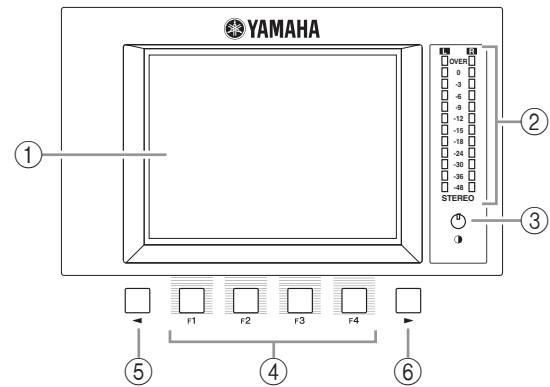
① **Display**

This is a 320 x 240 dot LCD display with a backlight.

② **Stereo meters**

These 12-segment level meters display the final output level of the Stereo Bus.

③ **Contrast control**

This control adjusts the display contrast.

④ **[F1]–[F4] buttons**

These buttons select a page from a multi-page screen. Selecting a tab at the bottom of the screen using one of these buttons displays the corresponding page. (See page 20 for more information on displaying a page.)

⑤ **Left Tab Scroll [◀] button**⑥ **Right Tab Scroll [▶] button**

If there are more pages available than the four whose tabs are currently displayed, use these buttons to display the additional tabs. These buttons are available only when the left or right Tab Scroll arrow appears.

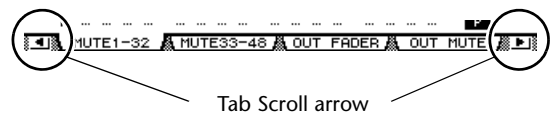

Tab Scroll arrow

SELECTED CHANNEL Section

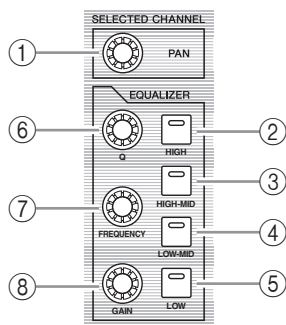

① **[PAN] control**

This control adjusts the pan of the channel selected by the [SEL] button.

② **[HIGH] button**

③ **[HIGH-MID] button**

④ **[LOW-MID] button**

⑤ **[LOW] button**

These buttons select the EQ band (HIGH, HIGH-MID, LOW-MID, LOW) of the channel selected by the [SEL] button. The corresponding button indicator of the currently-selected band lights up.

⑥ **[Q] control**

This control adjusts the currently-selected band Q.

⑦ **[FREQUENCY] control**

This control adjusts the currently-selected band frequency.

⑧ **[GAIN] control**

This control adjusts the currently-selected band gain.

SCENE MEMORY Section

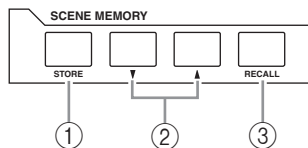

① **[STORE] button**

This button enables you to store the current mix settings. (See page 42 for more information on Scene Memories.)

② **Scene Up [▲] / Down [▼] buttons**

These buttons select a Scene to store or recall. Pressing the Scene Up [▲] button increments the selection; pressing the Scene Down [▼] button decrements the selection. Holding down either key increments or decrements the selection continuously.

③ **[RECALL] button**

This button recalls the Scene memory selected by the Scene Up [▲] / Down [▼] buttons.

USER DEFINED KEYS Section

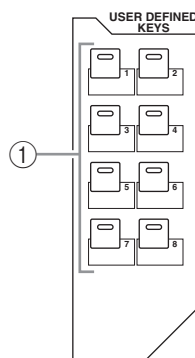

① **[1]–[8] buttons**

You can assign any of the 167 functions to these User Defined buttons.

Data Entry Section

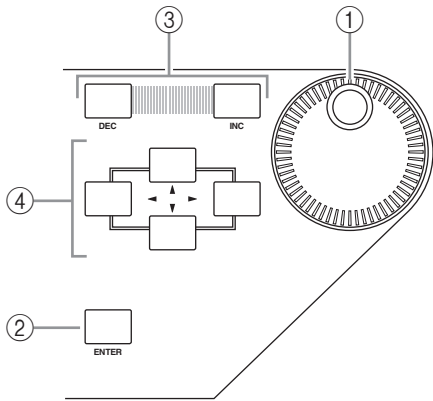

① Parameter wheel

This control adjusts the parameter values shown on the display. Turning it clockwise increases the value; turning it counterclockwise decreases the value. This wheel also enables you to scroll a displayed list and select a character for entry (see page 21).

② [ENTER] button

This button activates a selected (highlighted) button on the display, and confirms the edited parameter values.

③ [DEC]/[INC] buttons

These buttons increment or decrement a parameter value by one. Pressing the [INC] button increments the value; pressing the [DEC] button decrements the value. Holding down either key increments or decrements the value continuously.

④ Left, Right, Up, Down ([◀]/[▶]/[▲]/[▼]) cursor buttons

These buttons move the cursor around the display pages, or select parameters and options. Holding down a cursor button moves the cursor continuously in the corresponding direction.

SOLO Section

① [SOLO] indicator

This indicator flashes when single or multiple channels are soloed.

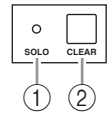

② [CLEAR] button

This button “unsolos” all soloed Channels.

Rear Panel

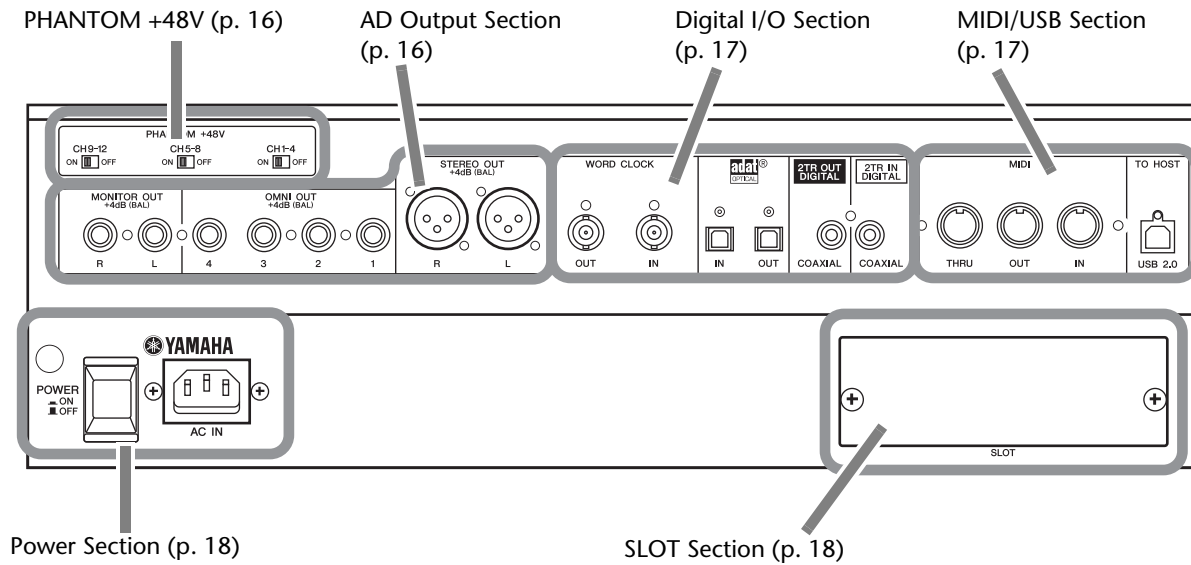

PHANTOM +48V

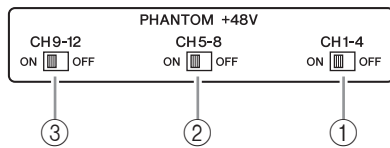

- ① CH1-4 ON/OFF switch
- ② CH5-8 ON/OFF switch
- ③ CH9-12 ON/OFF switch

Each of these switches turns on or off the +48V phantom power feed to four corresponding inputs. When the switches are on, +48V phantom power is supplied to the INPUT A connectors.

Note:

- Make sure that this switch is turned off if phantom power is not required.
- Before you turn on phantom power, make sure that only devices requiring phantom power (such as condenser mics) are connected. Supplying phantom power to a device that does not require it will cause malfunctions.
- Do not connect or disconnect a device while phantom power is on. Doing so will damage the device or the console.
- To protect your speakers, make sure that the power amps (powered speakers) are off before you turn phantom power on or off. We also recommend that all output level faders be minimized. If you fail to observe these precautions, high volume output may occur, possibly damaging your hearing or your equipment.

AD Output Section

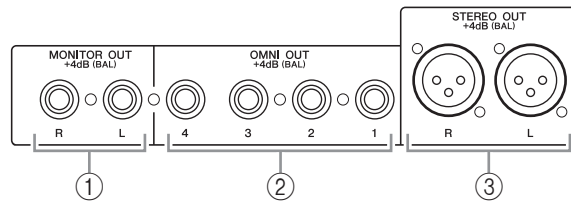

- ① MONITOR OUT connectors L/R

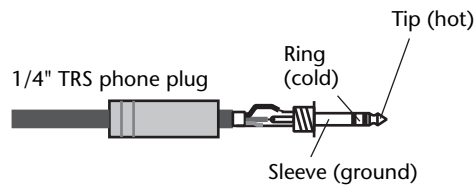

These balanced TRS phone-type connectors output monitoring signals or 2TR IN signals. The nominal signal level is +4 dB. You can select signals using the Monitor Source selector.

- ② OMNI OUT connectors 1-4

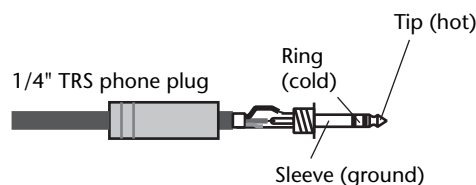

These balanced TRS phone-type connectors output any Bus signals or channel Direct Out signals. The nominal signal level is +4 dB.

③ STEREO OUT connectors L/R

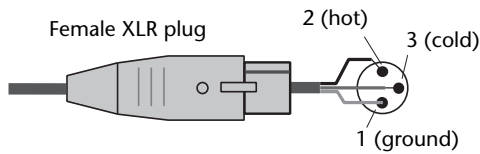

These balanced XLR-3-32-type connectors output the Stereo Out signals. The nominal signal level is +4 dB.

Digital I/O Section

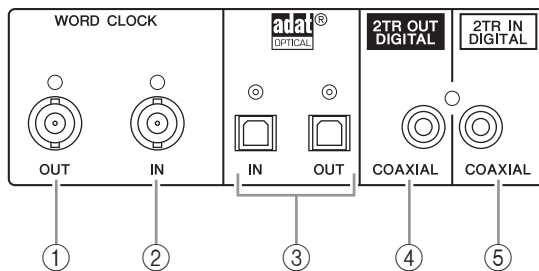

① WORD CLOCK OUT connector

This BNC connector outputs a wordclock signal from the 01V96i to a connected external device.

② WORD CLOCK IN connector

This BNC connector inputs a wordclock signal from a connected external device to the 01V96i.

③ ADAT IN/OUT connectors

These optical connectors input and output ADAT digital audio signals.

④ 2TR OUT DIGITAL COAXIAL

This RCA phono connector outputs consumer format (IEC 60958) digital audio. The connector is typically used to connect the digital stereo input (consumer format) of a DAT recorder, MD recorder, or CD recorder.

⑤ 2TR IN DIGITAL COAXIAL

This RCA phono connector accepts consumer format (IEC 60958) digital audio. The connector is typically used to connect the digital stereo output (consumer format) of a DAT recorder, MD recorder, or CD recorder.

MIDI/USB Section

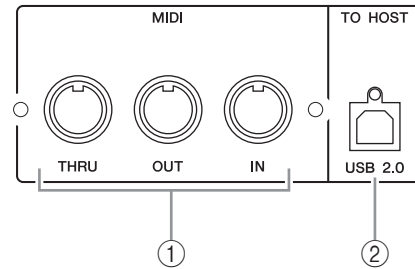

① MIDI IN/THRU/OUT ports

These standard MIDI IN, OUT and THRU ports enable you to connect the 01V96i to other MIDI equipment.

② TO HOST USB port

This USB port enables you to connect a computer equipped with a USB 2.0 port.

Note when using the TO HOST USB port

When connecting the 01V96i to a computer via the TO HOST USB port, please take the following measures.

If you fail to take these measures, your computer or the 01V96i may stop operating (hang up), or data may be lost or damaged. If the computer or console stops operating, turn the power off and on again, and reboot the computer.

- Before connecting the TO HOST USB port to your computer, disable the power conservation (suspend/sleep/standby/hibernate) settings of your computer.
- Connect the TO HOST USB port to the computer before you power-on the console.
- Before powering the console on/off or connecting/disconnecting the USB cable, you must do the following.
 - Close all applications.
 - Make sure that the console is not transmitting data. (The console also transmits data when you operate its buttons or move its faders.)
- Leave an interval of at least six seconds between powering the console off and on, or between disconnecting and reconnecting the USB cable.

SLOT Section

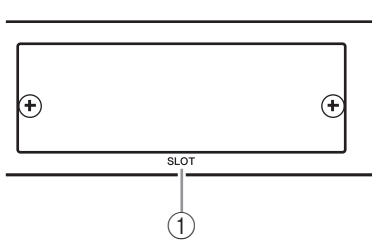

① SLOT

Optional mini-YGDAI (Yamaha General Digital Audio Interface) I/O cards can be installed in this slot. You can install AD/DA cards or digital I/O cards supporting a variety of digital formats including AES/EBU, ADAT, and Tascam.

Input signals from an I/O card can be patched to any desired input channel or insert-in (see page 29).

The output signal of any desired bus or the direct signal of an input channel can be patched to an output of an I/O card (see page 30).

Note:

- See page 63 for information on the mini-YGDAI I/O cards that can be currently used.
- For the latest information about I/O cards, refer to the Yamaha Pro Audio website. <http://www.yamahaproaudio.com/>

Power Section

① POWER ON/OFF switch

This switch turns the power to the 01V96i on or off.

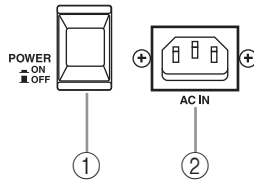

Note: To prevent loud clicks and thumps in your speakers, turn on your audio equipment in the following order (reverse this order when turning the equipment off)—sound sources, multitrack and master recorders, 01V96i, monitoring power amplifiers.

② AC IN connector

This connector enables you to connect the 01V96i to an AC outlet via the supplied power cord. Be sure to plug the AC power cord into this connector before plugging the power cord into an AC outlet.

⚠ Caution

Even when the POWER ON/OFF switch is in the off position, a small amount of electricity is still flowing to the unit. When you are not using the 01V96i for a long time, make sure to unplug the AC power cord from the AC outlet.

Installing an Optional Card

Visit the following Yamaha Pro Audio web site to ensure that the card you are installing is supported by the 01V96i.

<http://www.yamahaproaudio.com/>

Follow the steps below to install an optional mini-YGDAI card.

1. Make sure that the power to the 01V96i is turned off.

2. Undo the two fixing screws and remove the slot cover, as shown below.

Keep the cover and fixing screws in a safe place for future use.

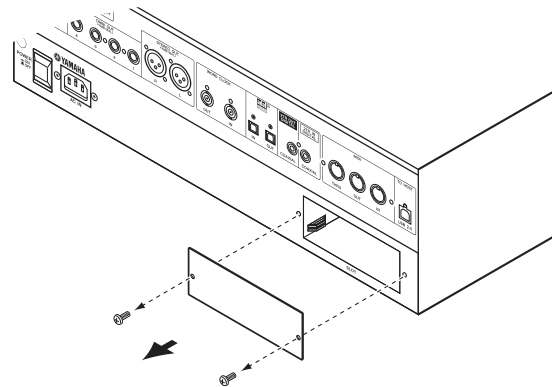

3. Insert the card between the guide rails and slide it all the way into the slot, as shown below.

You may have to push firmly to fully insert the card into the internal connector.

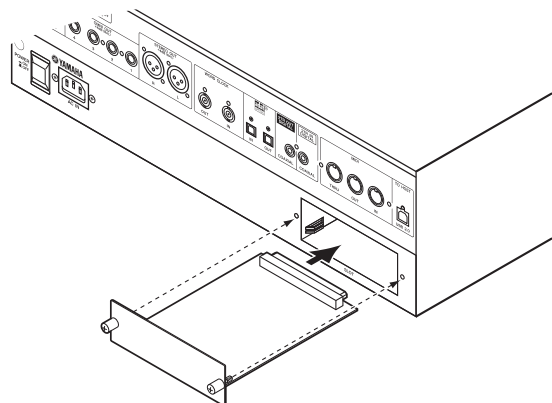

4. Secure the card using the attached thumbscrews.

Tighten the screws firmly to secure the card. Otherwise, the card may not be grounded correctly.

Operating Basics

This chapter describes basic operations on the 01V96i, including how to use the display and operate the controls on the top panel.

About the Display

The top panel display indicates various parameters that you must set before you can operate the 01V96i. The display indicates the following items:

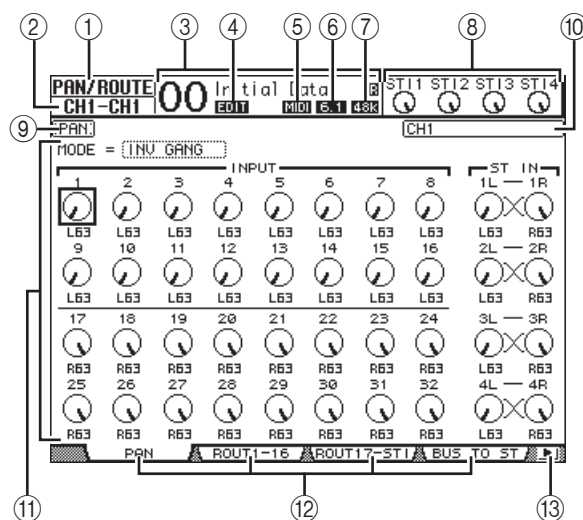

① Selected DISPLAY

This section indicates the currently-selected display page group.

② Selected channel

This section indicates the Input or Output Channel currently selected by its corresponding [SEL] button. The first four characters are the Channel ID (e.g., CH1–CH32, BUS1–BUS8, AUX1–AUX8, ST-L, ST-R). The second four characters are the channel's Short name. You can edit the short name if you desire (see page 43).

③ Current Scene

This section indicates the number and title of the currently-selected Scene memory. If the selected Scene is write-protected, a padlock icon (🔒) appears.

④ EDIT indicator

This indicator appears when the current mix settings no longer match those of the Scene that was most-currently recalled.

⑤ MIDI indicator

This indicator appears when the 01V96i is receiving MIDI data via the MIDI IN port, USB port, or an installed card.

⑥ Surround mode indicator

This indicator identifies the currently-selected Surround mode (ST=stereo, 3-1, 5.1, or 6.1).

⑦ Sampling rate indicator

This indicator identifies the 01V96i's current sampling rate: 44.1 kHz (44k), 48 kHz (48k), 88.2 kHz (88k), or 96 kHz (96k).

⑧ ST IN channel levels

These level controls indicate the level of ST IN channels 1–4.

⑨ Page title

This section indicates the title of the current page.

⑩ Channel name

On certain pages, this area displays the Long name of the channel currently selected by the [SEL] key or the channel selected by the cursor keys.

⑪ Page area

This page area displays various page contents.

⑫ Page tabs

These tabs enable you to select a display page.

⑬ Tab Scroll arrows

These arrows indicate that more pages are available.

Selecting Display Pages

To select a display page:

1. Press the corresponding button on the top panel to select the desired page group.

Display pages are grouped by function. To select a page group, press the desired button in the DISPLAY ACCESS section.

2. You can select pages that have currently-displayed tabs by pressing the [F1]–[F4] buttons.

If the selected display page group contains multiple pages, press the [F1]–[F4] buttons below the corresponding tab to select a specific page.

3. To select a page for which a tab is not currently displayed, press either the Left or Right [◀]/[▶] Tab Scroll button (depending on where the page is located) to display the page tab, then press the corresponding [F1]–[F4] button.

If display page groups contain more than four pages, either the left or right arrow appears. To display the currently-hidden tabs, press the Right or Left [◀]/[▶] Tab Scroll button.

You can also select a page from a page group as follows:

- **Selecting the next page in a page group:**
Press the button you selected in Step 1 repeatedly. This enables you to select a page that has a hidden tab.
 - **To select the previous page in a page group:**
Press and hold down the button you selected in Step 1. The screen steps back through the pages one by one. Release the button when the desired page is displayed. This enables you to select a page that has a hidden tab.
 - **To select the first page in the group:**
Double-click the button you selected in Step 1.
- ### 4. Press the cursor buttons to move the cursor (a bold frame) to a button, parameter box, rotary control, or fader so that you can change the value.

Tip: The 01V96i remembers the current page and parameter when you select a new page group. If you return to the previous page group, the 01V96i displays the correct page, with the same parameter selected.

Display Interface

This section describes how to use the display interface.

Rotary Controls & Faders

The rotary controls and faders enable you to adjust the continuously variable parameter values, including Input Channel levels and effects parameters. Press the cursor buttons to move the cursor to a rotary control or fader you want to adjust, then rotate the Parameter wheel or press the [INC]/[DEC] buttons to modify the value.

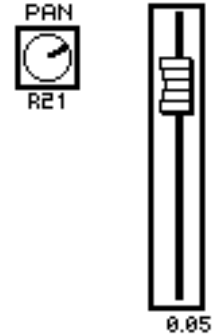

Buttons

The buttons enable you to turn certain functions on (enabled) or off (disabled). Move the cursor to the appropriate button, then press the [ENTER] button to turn the function on (high-lighted) or off. The buttons also enable you to select one of two options or to execute certain functions.



Parameter Boxes

The parameter boxes enable you to select one of multiple options. Press the cursor buttons to move the cursor to a parameter box, then rotate the Parameter wheel or press the [INC]/[DEC] buttons to select the setting.

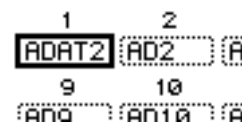

You may need to press the [ENTER] button to confirm a change in certain parameter boxes. If you edit a value in this type of parameter box, the value flashes. Press the [ENTER] button to confirm the change, and the flashing stops. If you move the cursor to other parameters while the edited value is flashing, the edit is cancelled.

Confirmation Messages

For certain functions, the 01V96i prompts you for confirmation before executing the functions, as shown here.

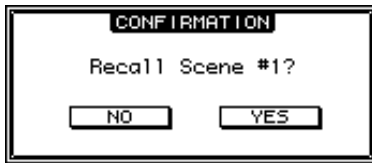

Move the cursor to YES and press [ENTER] to execute the function, or move the cursor to NO and press [ENTER] to cancel.

If you take no action for awhile, the confirmation window closes automatically and the function is not executed.

Title Edit Window

The Title Edit window enables you to enter titles for Scene and library memories. You can enter 4, 12, or 16 characters, depending on the item.

The figure on the left shows uppercase characters and various punctuation marks. The figure on the right shows lowercase characters and numbers.

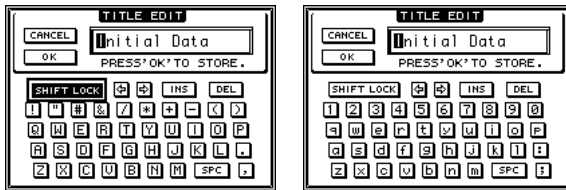

Use the cursor buttons to select characters, and press the [ENTER] button to enter them into the title. The cursor moves to the right automatically as each character is entered. Use the Parameter wheel to move the cursor within the title.

Use the SHIFT LOCK button to select uppercase or lowercase characters, and use the SPC button to enter a space.

To insert a space at the cursor position and move subsequent characters to the right, move the cursor to the INS button and press [ENTER].

To delete the character at the cursor position and move subsequent characters to the left, move the cursor to the DEL button and press [ENTER].

When you have finished, move the cursor to the OK button, then press [ENTER] to confirm the title. To cancel the title entry, move the cursor to the CANCEL button, then press [ENTER].

Selecting Layers

Input Channels and Output Channels (Bus Outs & Aux Outs) are arranged into layers, as illustrated below. There are four layers altogether.

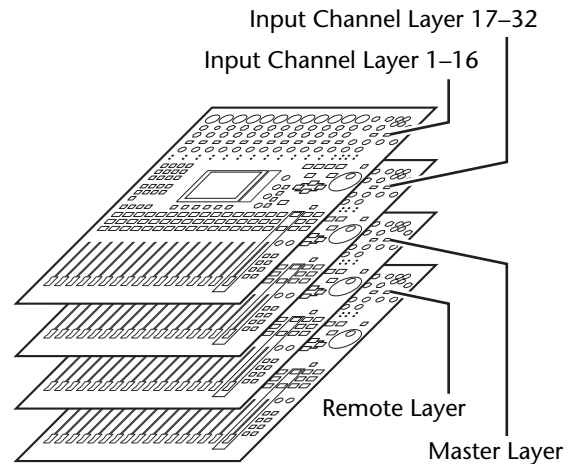

The currently-selected layer determines the function of the channel strip, [SEL] buttons, [SOLO] buttons, [ON] buttons, and faders. Use the LAYER buttons to select a layer you wish to edit using the channel strip controls.

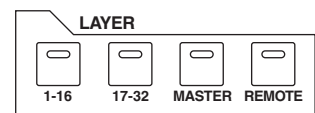

The following table shows the layers that you can access using the LAYER buttons, and the parameters you can control using the channel strips on each layer.

LAYER buttons	Layers	Channel Strips	
		1-8	9-16
[1-16] button	Input Channel Layer 1-16	Input Channels 1-16	
[17-32] button	Input Channel Layer 17-32	Input Channels 17-32	
[REMOTE] button	Remote Layer	Operation depends on the selected target.	
[MASTER] button	Master Layer	Aux Send masters 1-8	Bus Out masters 1-8

Tip:

- The function of each channel strip fader depends on the currently-selected Fader mode (see page 22).
- The STEREO [SEL] button, [ON] button, and [STEREO] fader always control the Stereo Out signal, regardless of the Layer settings.
- The ST IN [SEL] buttons, [SOLO] buttons, [ON] buttons, and level control knobs always adjust the ST IN channels selected via the [ST IN] button regardless of the Layer settings.

Selecting Channels

To select a channel on the 01V96i, press the corresponding [SEL] button. To adjust the Pan and EQ settings, use the rotary controls in the SELECTED CHANNEL section. To select a channel on pages that cover multiple channels, press the corresponding [SEL] button.

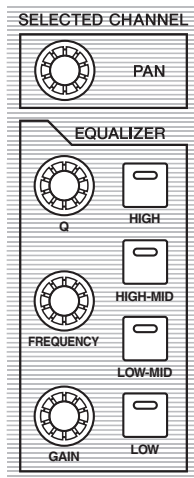

1. Press the corresponding LAYER button to select a layer that includes the desired channel (see page 21).

To select ST IN channels, press the [ST IN] button.

2. Use the corresponding [SEL] button to select the desired channel.

The channel is selected and the [SEL] button indicator lights up.

The Channel's ID and short name appear in the upper-left corner of the display. If the currently-displayed page contains a relevant channel parameter, the cursor moves to that parameter automatically. If the currently-displayed page contains no such parameter, a page that does contain such a parameter is selected automatically.

Tip: For paired Input or Output Channels, the channel for which you pressed the [SEL] button is selected, and its indicator lights up. The [SEL] button indicator of the paired partner flashes.

3. To select the Stereo Out, press the STEREO [SEL] button.

Repeatedly pressing the STEREO [SEL] button toggles between the Stereo Out left and Stereo Out right channels.

If the currently-displayed page contains a relevant Stereo Out parameter, the cursor moves to that parameter automatically. If the currently-displayed page contains no such parameter, a page that does contain such a parameter is selected automatically.

Selecting Fader Modes

The function of channel faders (1–16) depends on the selected Layer and Fader mode.

1. Select a layer that includes the desired channel (see page 21).
2. Press the FADER MODE buttons to select a Fader mode.

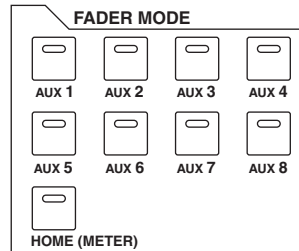

The button indicators identify the following Fader modes:

- **When the [HOME] button indicator lights up:**
You can use channel faders to control Input Channels and ST IN Channel levels or Output Channels (Aux Out 1–8, Bus Out 1–8) master levels.
- **When one of the [AUX1]–[AUX8] button indicators light up:**
You can use channel faders to control the corresponding Aux Send level.

The following table shows the channel fader functions for each Layer and Fader mode.

LAYER buttons	Fader Mode	Channel Strip Fader	
		1–8	9–16
[1–16] button	[HOME] button	Input Channel 1–16 level	
	[AUX1]–[AUX8] buttons	Input Channel 1–16 Aux Send level	
[17–32] button	[HOME] button	Input Channel 17–32 level	
	[AUX1]–[AUX8] buttons	Input Channel 17–32 Aux Send level	
[REMOTE] button	[HOME] button	Operation depends on the selected target.	
	[AUX1]–[AUX8] buttons		
[MASTER] button	[HOME] button	Aux Send master 1–8 output level	Bus Out master 1–8 output level
	[AUX1]–[AUX8] buttons	No operation	

Note: You cannot select the [AUX1]–[AUX8] buttons while the Master layer is selected. If you switch to the Master layer while one of the [AUX1]–[AUX8] button indicators is lit, the indicator automatically turns off and the [HOME] button indicator lights up.

Metering

This section describes how to check Input and Output Channel levels using the Meter pages.

1. Press the FADER MODE [HOME] button repeatedly until the Meter | Position page appears.

This page enables you to set the metering position for Input and Output Channels.

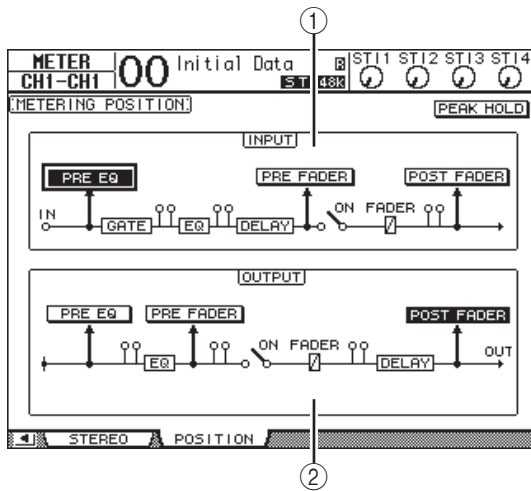

① INPUT section

This section enables you to select the metering position for Input Channel and ST IN Channel signals.

② OUTPUT section

This section enables you to select the metering position for Output Channel (Aux Out 1–8, Bus Out 1–8, Stereo Out) signals.

2. Move the cursor to the desired parameter button in the INPUT or OUTPUT section, then press [ENTER].

You can select one of the following three positions in each section.

- PRE EQImmediately before EQ.
- PRE FADERImmediately before the fader.
- POST FADERImmediately after the fader.

3. Press the FADER MODE [HOME] button repeatedly until the page listed below that contains the desired channels appears.

• CH1-32 page

This page displays the Input Channel 1–32 levels respectively.

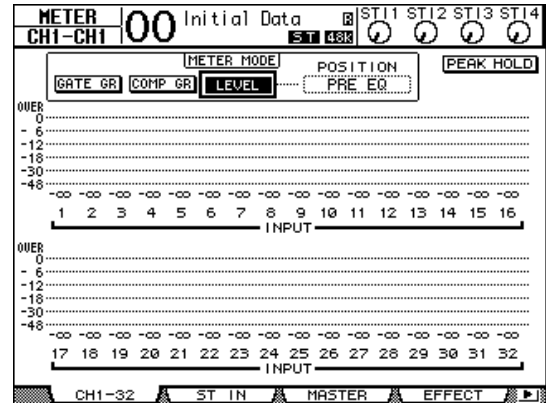

• ST IN page

This page displays the left and right ST IN Channel 1–4 levels separately.

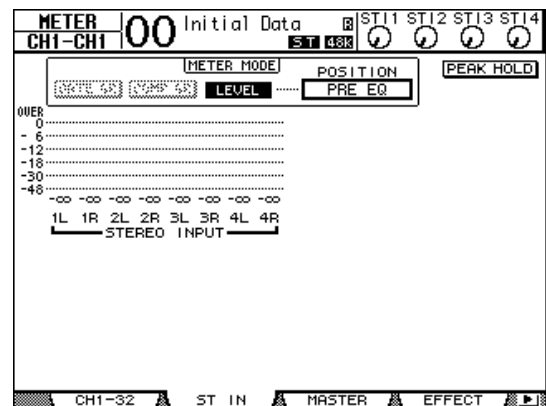

• Master page

This section displays the Output Channel (Aux Out 1–8, Bus Out 1–8, Stereo Out) levels altogether.

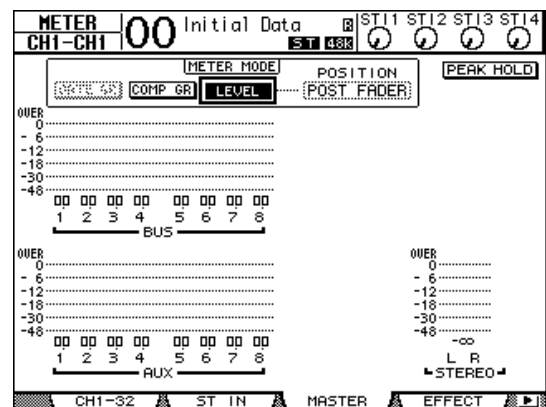

- **Effect page**
This page displays the internal effects processor 1–4 input and output levels altogether.

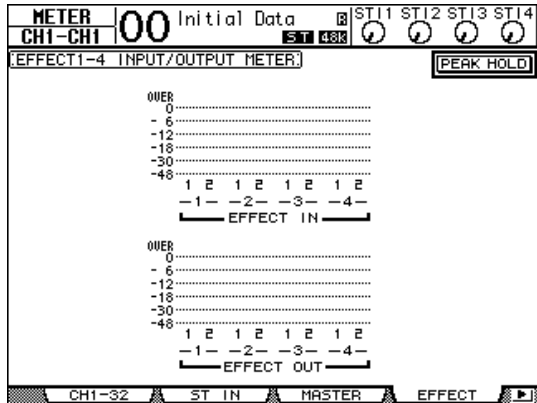

- **Stereo page**
This page displays the Stereo Out output level.

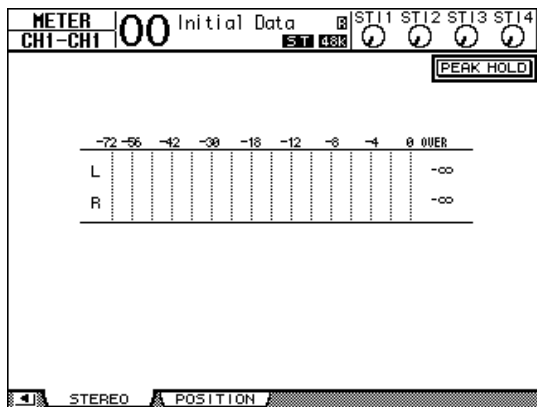

If you selected the CH1-32 page or the Master page, use the MASTER MODE parameter to select one of the following three metering signal types:

- **GATE GR**.....The amount of gain reduction for the gate (only for CH1-32)
- **COMP GR**The amount of gain reduction for the compressor
- **LEVEL**Input Channel input level, or Output Channel output level

Tip: These pages also allow you to change the metering position using the POSITION parameter. This parameter setting operates in unison with the Meter | Position page setting.

4. To activate the Peak Hold function, move the cursor to the PEAK HOLD button, then press [ENTER].

The PEAK HOLD button turns on, and the peak level is held on the meters on the page. To cancel the Peak Hold function, turn the PEAK HOLD button off.

Connections and Setup

This chapter explains how to connect and set up your 01V96i.

Connections

The following section explains two typical ways to connect the 01V96i to external equipment, although there are numerous others.

■ Configuring an analog 16–24-channel mixing system

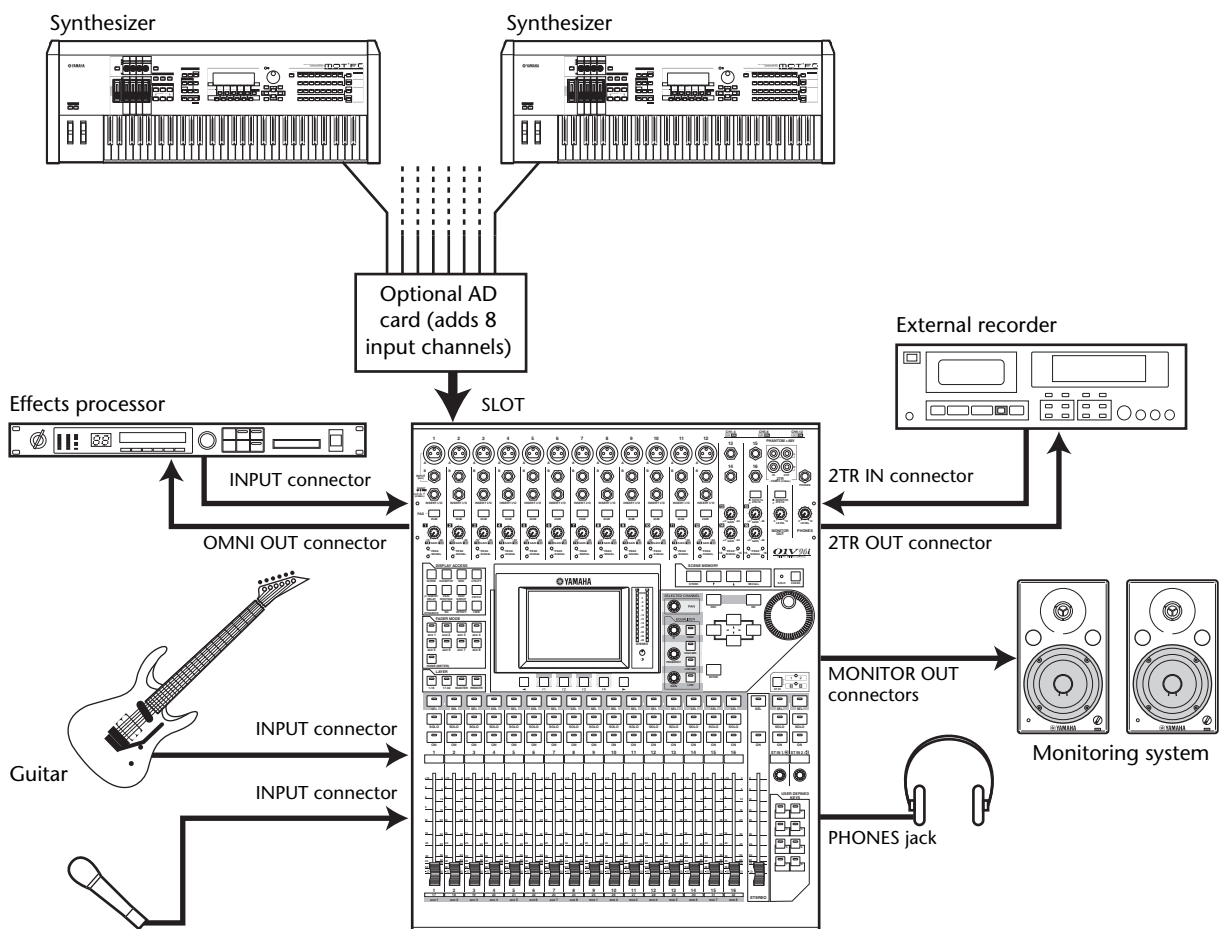

This illustration shows a simple system with 16 analog channels using the 01V96i's INPUT connectors 1–16.

If an optional AD card (such as the MY8-AD or MY8-AD96) is installed in the slot, up to 24 analog channels can be mixed.

Tip: You can adjust the gain of the AD card channels by setting the DIP switches on the card. For more information, see your AD card documentation.

■ Configuring a recording system that uses a DAW (Digital Audio Workstation)

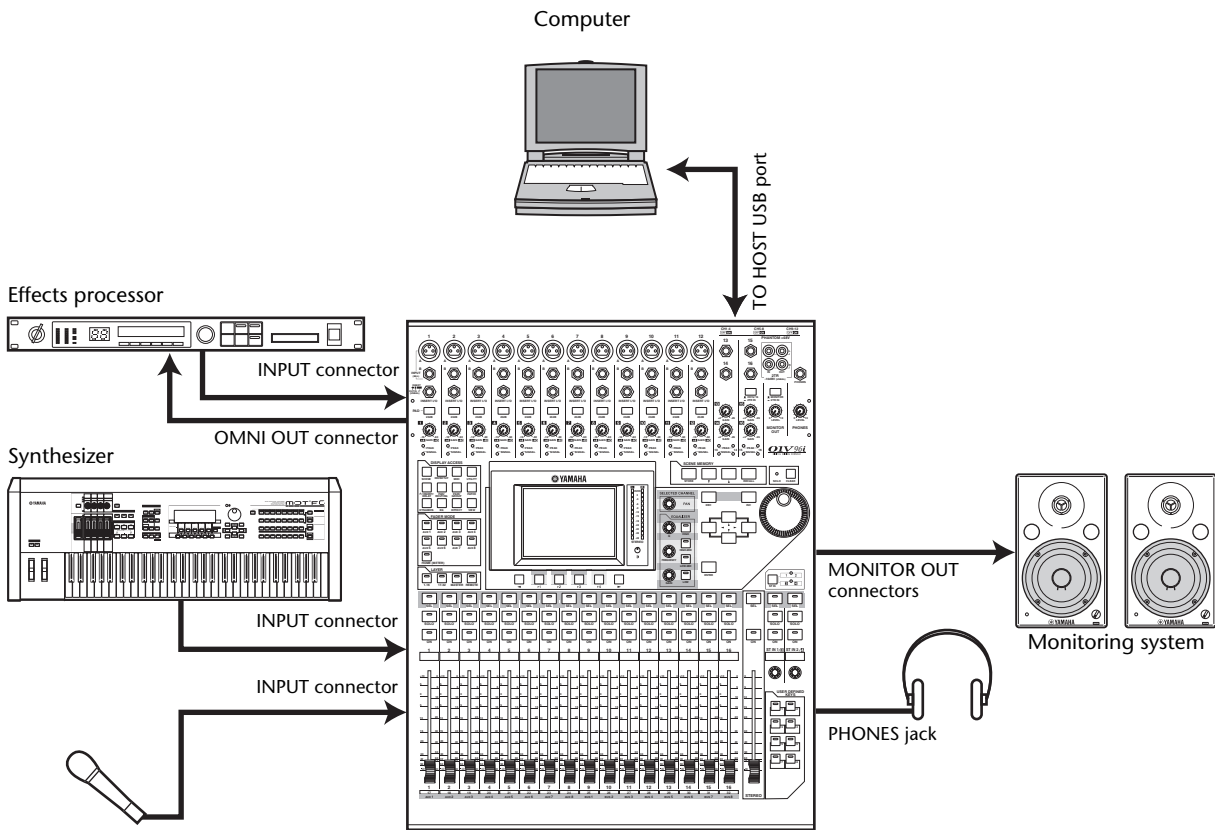

In this system, the 01V96i is connected to a computer-based DAW (Digital Audio Workstation). This allows the 01V96i to be used as an audio interface with 16-channel input and output. The 01V96i's remote functionality can also be used to perform locate and transport operations on the DAW, and to edit its parameters.

Wordclock Connections and Settings

About Wordclock

Digital audio equipment must be synchronized when digital audio signals are transferred from one device to another. Even if both devices use identical sampling rates, digital signals may not transfer correctly, or audible noise or unwanted clicks may occur if the digital audio processing circuits inside each digital audio device are not synchronized with each other.

Wordclocks are signals that enable digital audio processing circuits to synchronize with each other. In a typical digital audio system, one device operates as the wordclock master, transmitting wordclock signals, and the other devices operate as wordclock slaves, synchronizing to the wordclock master.

If you are digitally connecting the 01V96i to other equipment, you must decide which device to use as the wordclock master and which devices to use as slaves, then set up all the devices accordingly. The 01V96i can be used as the wordclock master running at either 44.1 kHz, 48 kHz, 88.2 kHz, or 96 kHz, or slaved to an external wordclock source.

Wordclock Connections

To establish wordclock synchronization between the 01V96i and external devices, you can distribute wordclock signals independently via dedicated cables, or you can use clock information derived from digital audio connections.

The WORD CLOCK IN and OUT connectors transmit and receive wordclock signals independently on the 01V96i. The following examples show two ways in which wordclock signals can be distributed and received via the WORD CLOCK IN and OUT connectors.

- **Daisy Chain Distribution**

In this example, the wordclock signal is distributed in a “daisy-chain” fashion, with each device feeding the wordclock signal from the wordclock out connector on to the wordclock in connector of the next device. This method of distribution is not recommended for larger systems.

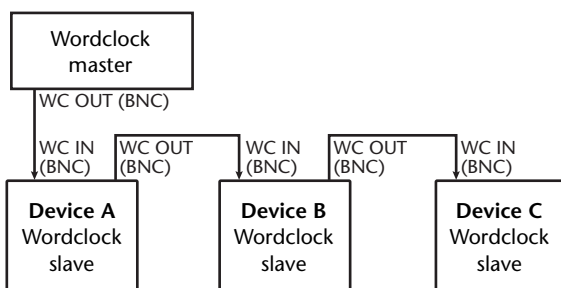

- **Star Distribution**

In this example, a dedicated wordclock distribution box is used to supply wordclock signals from the wordclock master to each wordclock slave individually.

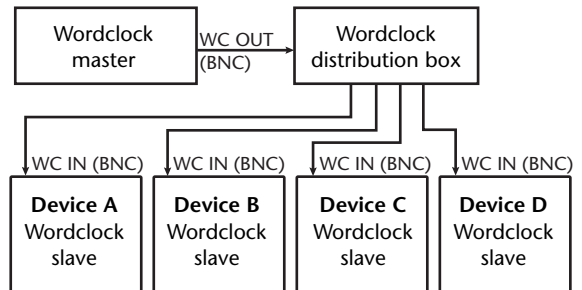

If the external devices do not have wordclock in and out connectors, you can use the clock information included in the digital audio signals. In this case, digital audio signals and wordclock signals are transferred via the 2TR OUT DIGITAL and 2TR IN DIGITAL jacks or via the digital I/O card installed in the rear panel slot.

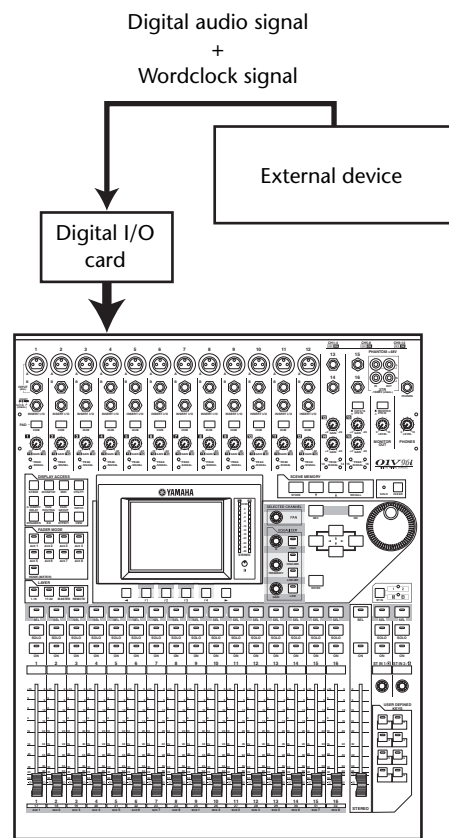

Specifying the Wordclock Source

To digitally connect the 01V96i to external devices, you must specify the wordclock source for the system. Follow the steps below.

Note: When you change the wordclock settings on any device in your digital audio system, some devices may output noise due to being out of synchronization. Be sure to turn down your monitoring device before changing wordclock settings.

1. Press the DISPLAY ACCESS [DIO/SETUP] button repeatedly until the DIO/Setup | Word Clock page appears.

On this page, you can view the current synchronization status of input signals at each slot and connector.

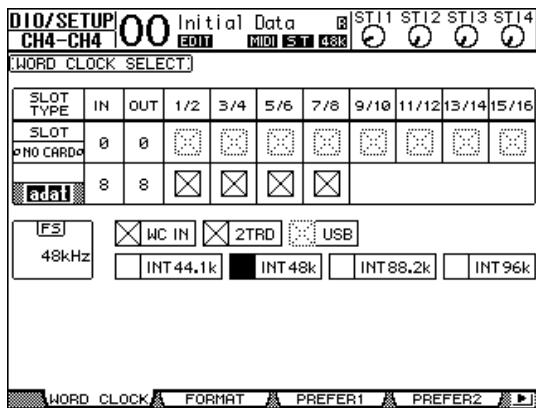

The source select button indicators are explained below:

- A usable wordclock signal is present at this input, and it is in sync with the current 01V96i internal clock.
- No wordclock signal is present at this input.
- A usable wordclock signal is present at this input, but it is out of sync with the current 01V96i internal clock.
- This input is the currently-selected wordclock source.
- This input was selected as the wordclock source, but no usable signal was received.
- Either this input is not receiving wordclock, or else it cannot be used with the currently-installed I/O card.

Tip:

- The FS box displays the sampling frequency at which the 01V96i is currently operating.
- The SLOT TYPE column displays the names of any installed I/O card.
- The IN and OUT columns indicate the number of input and output channels available for each installed I/O card.

2. Use the cursor buttons to move the cursor to a source, then press [ENTER].

The following are possible wordclock sources.

However, USB only displays the synchronization status, and cannot be selected as the wordclock master.

- **SLOT**
These buttons select the inputs from the digital I/O card installed in the slot as the wordclock source. Inputs are selected in pairs (odd and even numbers in this order). The SLOT TYPE column displays the names of any installed I/O card. The number of pairs depends on the type of I/O card installed.
- **adat**
These buttons select the inputs from the ADAT IN connector on the rear panel. Inputs are selected in pairs (odd and even numbers in this order).
- **WC IN**
This button selects the wordclock signal input at the WORD CLOCK IN connector on the rear panel.
- **2TRD**
This button selects the 2TR IN DIGITAL input as the wordclock source.
- **INT 44.1k, INT 48k, INT 88.2k, INT 96k**
These buttons select the internal clock generator as the wordclock source. The 01V96i will function as the wordclock master.
- **USB (display only)**
This indicates the synchronization status of the signal being input from the TO HOST USB port. It cannot be selected as the wordclock master.

Note: To transfer data at higher sampling frequencies (88.2 kHz or 96 kHz) between the 01V96i and connected external devices, you need to set the data transfer format.

Tip: If wordclock transfer is interrupted while the 01V96i (being used as a slave unit) is receiving the clock signal, the unit will automatically switch to an internal clock (INT 44.1k/ INT 48k/INT 88.2k/INT 96k) that is closest to the interrupted clock.

Input and Output Patching

The 01V96i is designed to enable you to patch (assign) signals to Inputs and Outputs. This section explains how to view the signals patched to Inputs and Outputs and change the assignment.

Tip: If the data from a connected instrument fails to be input, or if you are unable to monitor the signal at the desired output, check the I/O patching, as explained below:

Patching Input Channels

By default, the Input Channels are patched as follows:

- INPUT connectors 1-16.....Input Channels 1-16
- ADAT IN channels 1-8.....Input Channels 17-24
- Slot channels 1-8.....Input Channels 25-32
- Outputs 1-2 of Internal Effects Processor 1-4ST IN Channels 1-4

Follow the steps below to view or change the patching.

1. Press the DISPLAY ACCESS [PATCH] button repeatedly until the following page appears.

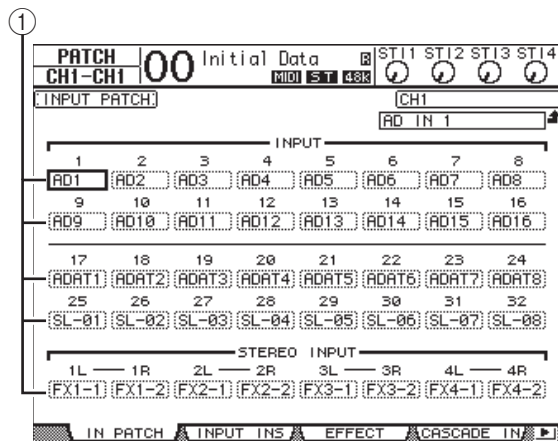

Inputs and Slot channels that are currently assigned to Input Channels are shown in the parameter boxes (1) beneath the channel numbers. The parameter indicators are explained below:

- - No assignment
- AD1-AD16 INPUT connectors 1-16
- USB 1-USB 16..... TO HOST USB port channels 1-16
- ADAT1-ADAT8 ADAT IN channels 1-8
- SL-01-SL-16..... Slot channels 1-16
- FX1-1-FX1-2..... Outputs 1-2 of Internal Effects Processor 1
- FX2-1-FX2-2..... Outputs 1-2 of Internal Effects Processor 2

- FX3-1-FX3-2Outputs 1-2 of Internal Effects Processor 3
- FX4-1-FX4-2Outputs 1-2 of Internal Effects Processor 4
- 2TD-L/R.....2TR IN DIGITAL L/R connectors

Follow the steps below to view or change the patching.

2. Use the cursor buttons to move the cursor to a patch parameter (1) for which you want to change the assignment, and rotate the Parameter wheel or press the [INC]/[DEC] buttons to modify the patching.

3. Press [ENTER] to confirm the change.

Tip: To restore the default patching, recall Input Patch memory #00.

Patching Omni Outs

By default, the output connectors are patched as follows:

- OMNI OUT connectors 1-4.... Aux Out 1-4
- ADAT OUT channels 1-8..... Bus Out 1-8
- Slot channels 1-8..... Bus Out 1-8
- Slot channels 9-16..... Bus Out 1-8
- 2TR DIGITAL connectors..... Stereo Out L & R

Tip:

- The STEREO OUT connectors always output the Stereo Bus signals.
- The MONITOR OUT connectors output monitor signals or the 2TR IN signals, depending on the Monitor Source selector setting.

Follow the steps below to view or change the patching.

1. Press the DISPLAY ACCESS [PATCH] button repeatedly until the following page appears.

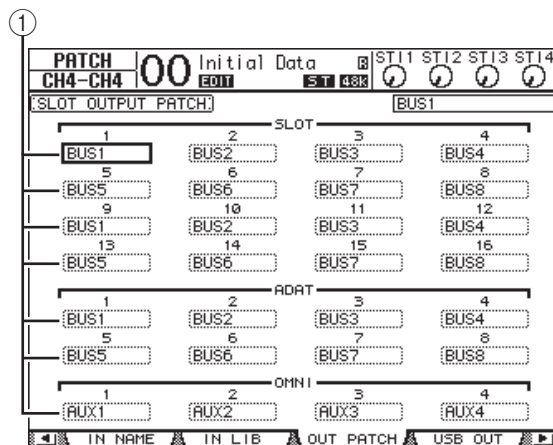

Signals that are currently assigned to the output connectors are shown in the parameter boxes (①) underneath the connector numbers. The parameter indicators are explained below:

- -No assignment
- BUS1–BUS8Bus Out 1–8 signals
- AUX1–AUX8Aux Out 1–8 Signals
- ST L/R.....Stereo Out signals
- INS CH1–INS CH32.....Input Channels 1–32
Insert Outs
- INS BUS1–INS BUS8Bus Out 1–8 Insert Outs
- INS AUX1–INS AUX8 ..Aux Out 1–8 Insert Outs
- INS ST-L/ST-RStereo Out Insert Outs
- CAS BUS1–BUS8Bus Out 1–8 Cascade
Outs
- CAS AUX1–AUX8.....Aux Out 1–8 Cascade
Outs
- CAS ST-L/ST-R.....Stereo Out Cascade Outs
- CASSOLOL/CASSOLOR ..Solo Channel Cascade
Outs

2. Use the cursor buttons to move the cursor to a patch parameter (①) you wish to change, and rotate the Parameter wheel or press the [INC]/[DEC] buttons to modify the patching.

3. Press [ENTER] to confirm the change.

Tip: To restore the default patching, recall Output Patch memory #00.

Patching output signals to USB OUT

By default, the following output signals are assigned to USB OUT.

- USB OUT1–8 Bus Out 1–8 signals
- USB OUT9–16... Bus Out 1–8 signals

If you want to change or verify this patching, proceed as follows.

1. Press [PATCH] repeatedly until the following page appears.

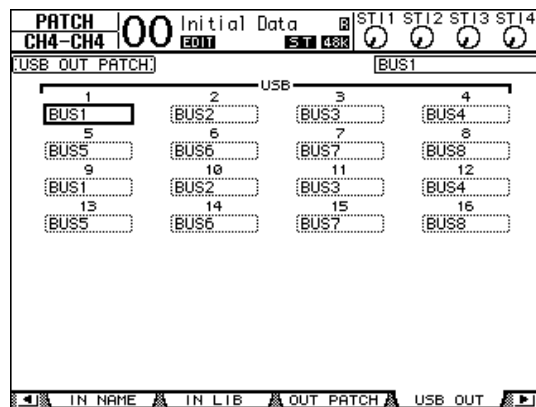

The parameter boxes underneath each number indicate the currently-assigned signal routing. The meaning of these indicators are explained below.

- -No assignment
- BUS1–BUS8..... Bus Out 1–8 signals
- AUX1–AUX8..... Aux Out 1–8 signals
- ST L/R Stereo Out signals
- INS CH1–INS CH32..... Input Channels 1–32
Insert Outs
- INS BUS1–INS BUS8.... Bus Out 1–8 Insert Outs
- INS AUX1–INS AUX8.. Aux Out 1–8 Insert Outs
- INS ST-L/ST-R..... Stereo Out Insert Outs

2. Move the cursor to a parameter box, and use the Parameter wheel (or [INC]/[DEC]) to modify the patching.

3. Press [ENTER] to confirm the change.

Tutorial

This chapter describes operations on the 01V96i, organized according to their purpose.

Input and Output Patching

The 01V96i allows you to freely connect external input/output connectors to the inputs and outputs of the internal mixer. The procedure is as follows.

Input Patching

1. Press the DISPLAY ACCESS [PATCH] button repeatedly until the Patch | In Patch page appears.

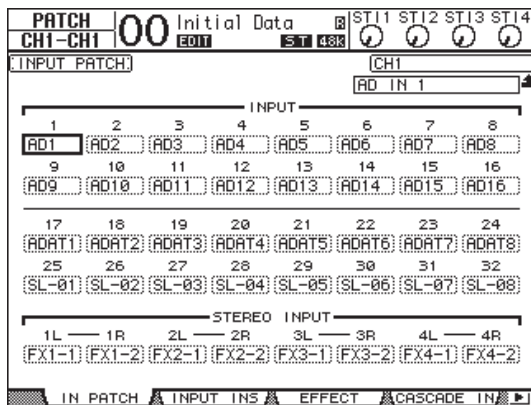

By default, signals from the instruments or mics connected to INPUT connectors 1–16 are sent to Input Channels 1–16. Input signals from the ADAT IN connector are sent to Input Channels 17–24, and input signals from the slot are sent to Input Channels 25–32.

2. Move the cursor to the parameter box of the input channel for which you want to change the assignment, and use the Parameter wheel or the [INC]/[DEC] buttons to modify the patching.

3. Press [ENTER] to confirm the change.

Note: Alternatively, you can move the cursor to the input channel's parameter box and then press [ENTER], and make a selection in the "PATCH SELECT" box. In this case, select the desired input connector and channel number, and press [INC] to confirm the change.

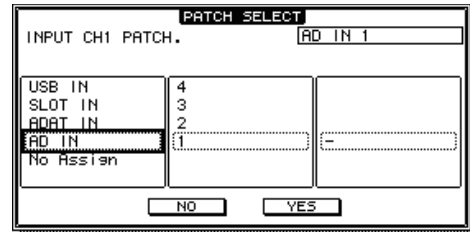

Output Patching

1. Press the [PATCH] button repeatedly until the Patch | Out Patch page appears.

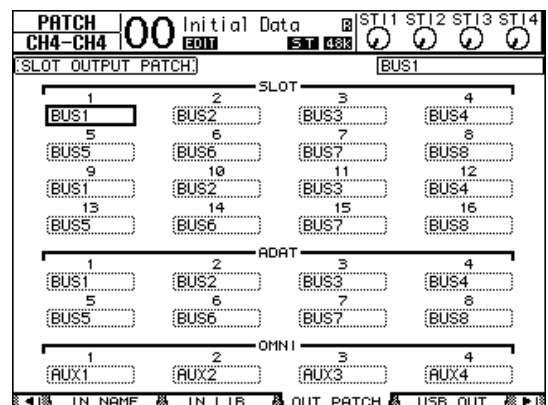

By default, the patching will be as shown in the illustration.

2. As you did when making input patch settings, move the cursor to the parameter box of the output channel, and use the Parameter wheel or the [INC]/[DEC] buttons to modify the patching.
3. Press [ENTER] to confirm the change.

Setting the Input Levels

The explanation here provides an example of adjusting the input level of the signals from instruments or mics connected to INPUT connectors, with the input patching in the default state.

1. While the musicians play the instruments or devices connected to the INPUT connector, adjust each [PAD] and [GAIN] so that [PEAK] flickers briefly when the maximum volume occurs..

Note: The [GAIN] controls adjust the analog input sensitivity. To make a high-quality recording with a wide dynamic range and little noise, set the [GAIN] controls as high as possible while avoiding clipping.

2. Press the LAYER [1–16] button.

Input Channel Layer 1–16 is now available for control from the channel strip section.

Note: Since the fader and [ON] button positions of each layer are memorized, those positions for the corresponding layer are restored when you switch to that layer.

3. Press the FADER MODE [HOME] button, then press the [F1] button to display the Meter | CH1-32 page.

Meter pages are the start point for mixing and recording. They display channel input and output levels, and compressor and gate gain reduction amounts. The CH1-32 page enables you to view Input Channel 1–32 levels and compressor and gate gain reduction amounts.

4. Make sure that the LEVEL button (①) is turned on in the METER MODE section.

The METER MODE section enables you to select the type of signals displayed on the meters. If any button other than the LEVEL button is turned on, move the cursor to the LEVEL button, then press [ENTER].

5. Move the cursor to the POSITION parameter box (②) to the right of the LEVEL button, rotate the Parameter wheel or press the [INC]/[DEC] buttons to select “POST FADER,” then press [ENTER].

The POSITION parameter indicates the metering position. When “POST FADER” is selected, the meters indicate the post-fader signal levels.

Note: If you set the POSITION parameter to “PRE EQ,” the pre-EQ input levels are metered. If you set the parameter to “PRE FADER,” the post-EQ and pre-fader input levels are metered.

6. Make sure that the [ON] button of the corresponding channel is on (lit), and raise the fader to the 0 dB position.

7. While the musicians play the musical instruments, check the input channel levels using the level meters on the display.

Note: If the meters reach the “OVER” level, make sure that the faders are set to 0dB, then lower the corresponding [GAIN] controls.

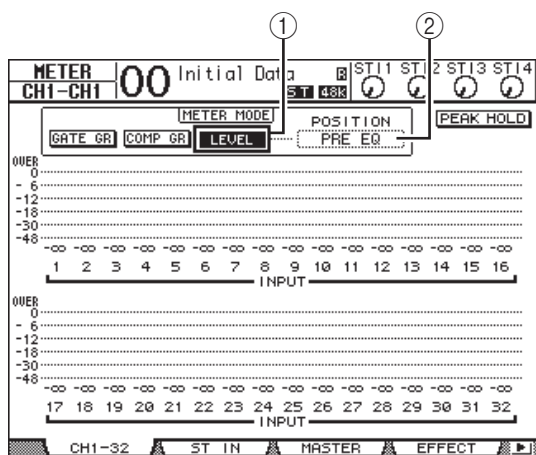

Pairing Channels

On the 01V96i, you can pair adjacent odd-even channels for stereo operation. Faders and most mix parameters of paired channels (excluding the Input Patch, phase, routing, and pan parameters) are linked. Pairing Input Channels is useful when you are connecting stereo sources, such as a CD player or synthesizer.

- To pair adjacent odd-even Input Channels, press and hold the [SEL] button for one of the channels you wish to pair, and press the [SEL] button for the adjacent channel.**

The corresponding two channels are paired, and the settings (such as faders, channel on/off, etc.) of the first channel are copied to the second channel. Subsequently, adjusting the linked parameters of one of the paired channels will adjust the parameters of its partner in the same way.

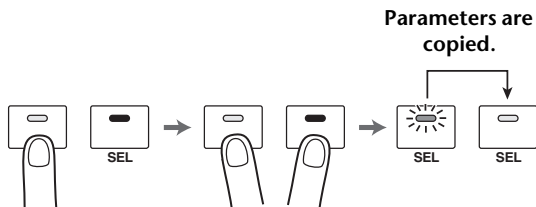

Tip: You can still select one of the paired channels for control by pressing the corresponding [SEL] button. When you select the channel, the [SEL] button indicator lights up, and the [SEL] button for the paired partner flashes.

- To cancel a pair, press and hold the [SEL] button for one of the paired channels, and press the [SEL] button for the other channel.**

Note: If you want to operate the faders of paired channels, make sure you operate only one fader for the pair. If you try to operate the faders for both channels in the pair, an excessive load will be applied to the fader motor, causing malfunction.

Setting the Routing

To record the 01V96i input signals to an external device, you must specify the destination of the signals for each Input Channel. This process is called “routing.” There are two routing methods.

- **Using Bus Outs 1–8**

Input Channel signals are first routed to Buses 1–8, then through Bus Outs 1–8 to the output connectors or channels. Use this method if you want to mix the signals of multiple Input Channels for output. If you desire, you can process the signals using the Bus Out 1–8 compressors and EQs.

In the following example, Input Channel signals are routed through Bus Outs 1 and 2 to ADAT OUT connectors 1 and 2.

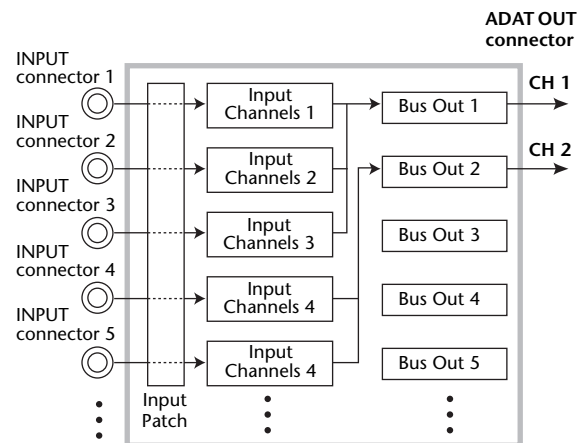

- **Using Direct Outs**

Each Input Channel signal is directly routed to and output from the specified output connectors and channels.

The following example illustrates the signals directly output from ADAT OUT channels 1–5.

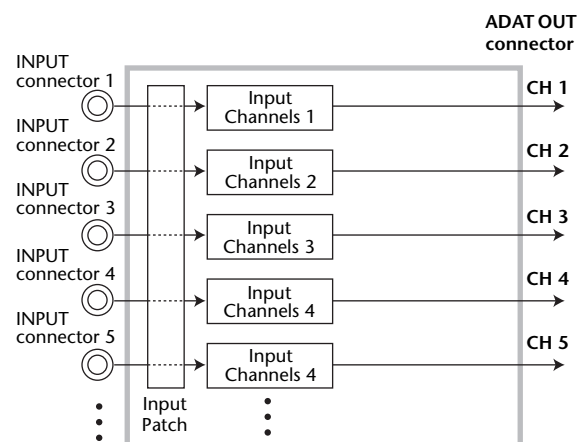

This section describes how to route signals by combining the above two routing methods.

1. Press the DISPLAY ACCESS [PAN/ROUTING] button repeatedly to display the Pan/Route | Rout1-16 page.

This page enables you to select a Bus Out as the signal destination for each channel.

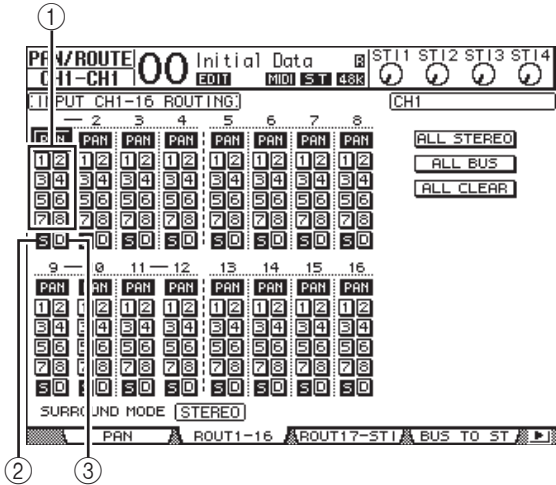

This page contains the following buttons:

- ① **1–8 buttons**
These buttons route Input Channel signals to Buses 1–8. You can select multiple buttons.
- ② **S button**
This button routes Input Channel signals to the Stereo Bus.
- ③ **D button**
This button routes Input Channel signals to the specified output connectors and channels directly.

2. Move the cursor to the S button for the Input Channel to which the musical instrument or microphone is connected, then press [ENTER] to turn it off.



By default, each Input Channel is routed to the Stereo Bus, which enables you to monitor the signals from the MONITOR OUT connectors and the PHONES jack. However during multitrack recording, or when monitoring the sound with the DAW's effects applied, you will usually want to monitor the signals returned from the recorder or DAW rather than the input signals themselves. To do so, you must turn off the S button so that the Input Channel signals will not be sent to the Stereo Bus.

3. To route Input Channel signals via Buses 1–8 to your recorder or DAW, use the 1–8 buttons to specify a Bus Out as the destination for each Input Channel to which an instrument or mic is connected.

In this example, Input Channels 1–4 are assigned to Buses 1 and 2, and Input Channels 5–8 are assigned to Buses 3 and 4.

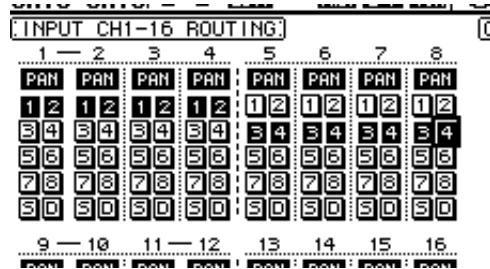

4. Press the [PAN/ROUTING] button repeatedly to display the Pan/Route | Pan page.

This page enables you to set the panpots for signals routed from the Input Channels to the Stereo Bus, and for signals routed from the Input Channels to the odd-even buses.

5. Move the cursor to the PAN parameter controls for the Input Channels that are assigned to the odd-even buses, then rotate the Parameter wheel or press the [INC]/[DEC] buttons to set the pan.

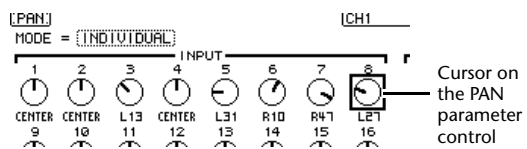

Tip: You can also use the [SEL] buttons to select Input Channels, and the SELECTED CHANNEL [PAN] control to adjust the pan setting.

6. To route Input Channel signals to Direct Outs, press the DISPLAY ACCESS [PATCH] button repeatedly until the Patch | Direct Out page appears.

The Direct Out page enables you to specify the output connectors or channels to which each Input Channel is directly patched.

7. Move the cursor to the parameter box for the Input Channels you want to route to Direct Outs, then specify the output connectors or channels.

In this example, Input Channel 9–12 signals are routed to ADAT OUT channels 5–8.

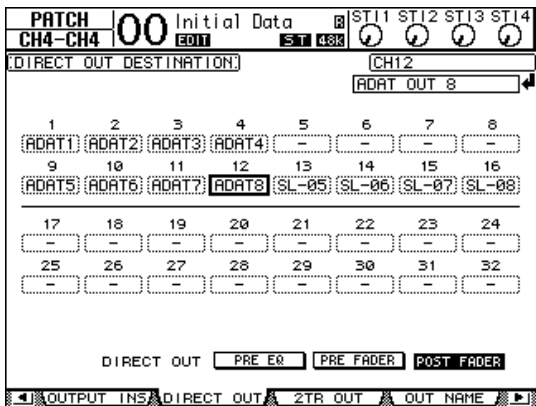

8. Press the DISPLAY ACCESS [PAN/ROUTING] button repeatedly until the Pan/Route | Rout1-16 page appears.

9. Move the cursor to the D button for the Input Channels you want to route to Direct Outs, then press [ENTER].

The Input Channels for which the D buttons are turned on are directly patched to the output connectors or channels specified in Step 7.



EQ'ing the Input Signals

The 01V96i's Input Channels feature 4-band full parametric EQ. This section describes how to use the EQ of an Input Channel to adjust the tonal character.

1. Press the LAYER [1–16] button.

Input Channel Layer 1–16 is now available for control from the channel strip section.

2. Press the [SEL] button for the Input Channel to which you want to apply EQ.

3. Press the [EQ] button, then the [F1] button to display the EQ | EQ Edit page.

The EQ Edit page enables you to adjust the EQ parameters for the currently-selected channel.

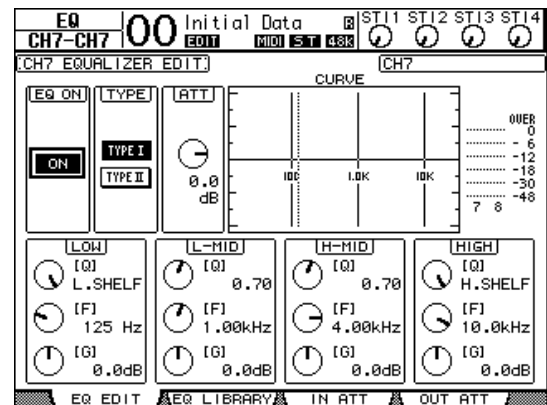

4. Make sure that the EQ ON button (in the upper-left corner) is turned ON.

The EQ ON/OFF button turns the currently-selected Input Channel's EQ on or off. If the button is off, press the [ENTER] button to turn it on.

5. While sound is being produced on the instrument or other device, adjust the EQ parameters.

To do so, move the cursor to the parameters in the lower half of the page, then rotate the Parameter wheel to change the values. You can adjust the following parameters for the LOW, L-MID, H-MID, and HIGH bands individually.

- Q

This parameter control specifies the Q (slope) for cut/boost of the center frequency set via the F parameter control. The setting range is between 10 and 0.10. The higher the value, the steeper the slope becomes. This parameter control also selects the type of EQ for the LOW and HIGH band.

• **F (Frequency)**

This parameter control specifies the center frequency for cut/boost, with a setting range of 21.2 Hz to 20.0 kHz.

• **G (Gain)**

This parameter control specifies the cut/boost amount in the range of -18.0 dB to +18.0 dB. The LOW and HIGH GAIN controls function as filter on/off controls when Q is set to HPF and LPF respectively.

You can also press the buttons ([HIGH], [HIGH-MID], [LOW-MID], [LOW]) in the SELECTED CHANNEL section to select the desired band and use the rotary controls ([Q], [FREQUENCY], [GAIN]) to directly edit the Q, F, and G parameters.

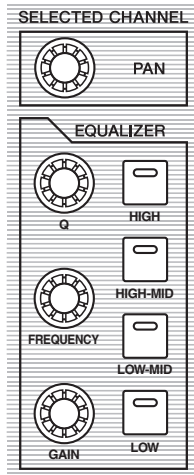

Tip:

- Turn the Q parameter control for the LOW band clockwise all the way to set the LOW-band EQ to "L. SHELF" (low-shelving), and counter-clockwise all the way to set it to "HPF" (high-pass filter).
- Turn the Q parameter control for the HIGH band clockwise all the way to set the HIGH-band EQ to "H. SHELF" (high-shelving), and counter-clockwise all the way to set it to "LPF" (low-pass filter).
- By default, the LOW band is set to "L. SHELF", and the HIGH band is set to "H. SHELF."

6. In the same way, adjust the EQ for the other channels.

Tip: The meters in the upper-right corner of the page indicate the post-EQ signal levels of the currently-selected Input Channel. If these meters reach the "OVER" position, lower the pre-EQ signal level using the ATT. parameter control located in the upper-left on the page.

Using the EQ Library

EQ settings can be recalled from the EQ library. EQ library memory numbers 1–40 contain preset EQ settings (programs) suitable for commonly-used instruments, allowing you to work efficiently.

1. Press the LAYER [1–16] button.

Input Channel Layer 1–16 is now available for control from the channel strip section.

2. Press the [SEL] button for the Input Channel to which you want to apply EQ.

3. Press the [EQ] button, then the [F2] button to display the EQ | EQ Library page.

4. Rotate the Parameter wheel to scroll the library title list, and select a program that you want to recall.

The selected program appears inside the dotted box.

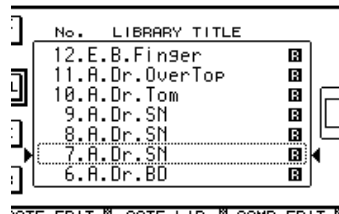

5. Move the cursor to the RECALL button located to the left of the library title list, then press [ENTER].

The selected program is recalled.

6. Press the [F1] button to display the EQ | EQ Edit page.

Adjust the parameters as desired.

Compressing the Input Signals

The 01V96i's Input Channels 1–32 feature individual channel compressors. A compressor is an effect used to make the volume level more consistent, or to restrain the maximum level in order to raise the overall volume. Here we describe how to use a compressor to process an input signal.

1. Press the LAYER [1–16] button.

Input Channel Layer 1–16 is now available for control from the channel strip section.

2. Press the [SEL] button of the Input Channel to which you want to apply compression.

3. Press the [DYNAMICS] button, then press the [F4] button.

The Dynamics | Comp Lib page appears. This page enables you to store compressor settings (programs) to the Compressor library, and recall compressor programs from the library. This example uses one of the compressor programs 1–36 from the Compressor library.

4. Rotate the Parameter wheel to scroll the library title list, and select a program that you want to recall.

The selected program appears inside the dotted box.

5. Move the cursor to the RECALL button located to the left of the library title list, then press [ENTER].

The selected program is recalled.

6. Press the [F3] button.

The 01V96i displays the Dynamics | Comp Edit page, which enables you to adjust compressor parameters.

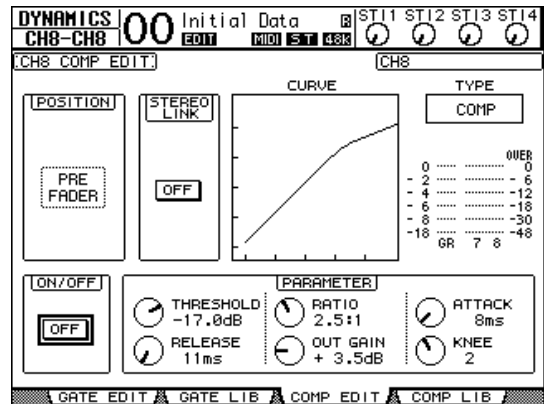

Tip:

- The 01V96i features four types of dynamics processors: COMP (Compressor), EXPAND (Expander), COMP. (S) (Compander Soft), and COMP. (H) (Compander Hard). These processors feature different parameters. (See the Reference Manual for the parameters for each compressor type.)
- You cannot change the compressor type on the Comp Edit page. To change the compressor type, recall a program that uses the desired compressor type from the Compressor library, then adjust the parameters as desired.

7. Press the [ENTER] button to turn on the ON/OFF button located in the lower-left corner of the page.

The ON/OFF button turns the currently-selected Input Channel's compressor on or off.

8. While sound is being produced on the instrument or other device, adjust the parameters of the compressor.

To do so, move the cursor to the desired parameter in the PARAMETER section on the page, then rotate the Parameter wheel or press the [INC]/[DEC] buttons.

Input Channels 1–32 feature a gate that can be used independently of the compressor. To use the gate, first press the [DYNAMICS] button, then the [F2] button to access the Gate library. After you recall a gate program, press the [Dynamics] button, then the [F1] button to display the Gate Edit page, which enables you to adjust gate parameters.

Using the Internal Effects

The 01V96i features four internal multi-effects processors that can be used via Aux Sends and Returns or by inserting them into specific channels. This section describes how to use internal Effects processor 1 via Aux Send 1, and apply reverb to the track signals.

1. Press the DISPLAY ACCESS [PATCH] button repeatedly until the Patch | Effect page appears.

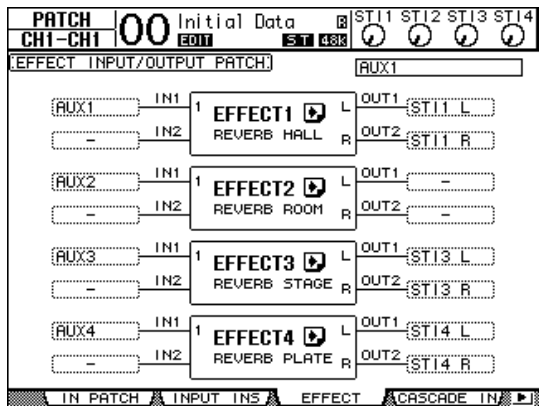

This page enables you to patch the inputs and outputs of Effects processors 1–4. By default, Aux Send 1 is patched to the input of Effects processor 1, and the output of Effects processor 1 is patched to ST IN Channel 1 L and R, as shown in the diagram above.

Tip: If the patch for internal Effects processor 1 is different from the above, use the Parameter wheel or [INC]/[DEC] buttons, and the [ENTER] button to change the patch.

2. Make sure that the [ON] button for ST IN Channel 1 in the ST IN section is turned on.

3. Press the DISPLAY ACCESS [EFFECT] button repeatedly until the Effect | FX1 Lib page appears.

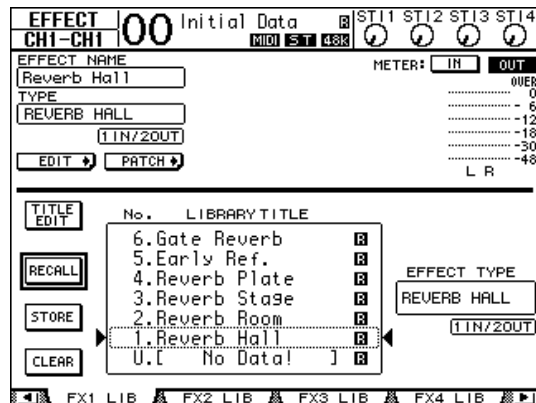

The Effect | FX1 Lib page enables you to recall effect programs to be used by Effects processor 1 from the Effects library, and store the current effects settings of Effects processor 1 to the Effects library.

Select from the list in the center column a program memory to which you wish to store the effects settings, or a program memory that you wish to recall. The selected program appears inside the dotted box.

4. Rotate the Parameter wheel and select “2. Reverb Room”

Here we’ll use room reverb as an example.

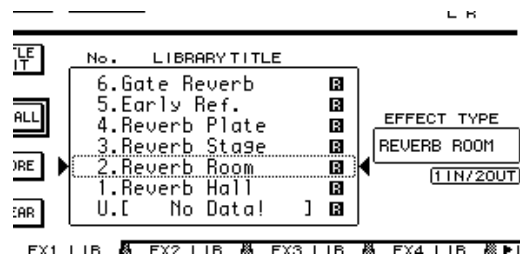

5. Move the cursor to the RECALL button located to the left of the list, then press [ENTER].

Effect program “Reverb Room” is loaded into Effects processor 1.

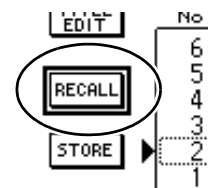

6. Press the [EFFECT] button repeatedly until the Effect | FX1 Edit page appears.

Adjust the parameters as desired.

7. Press the LAYER [1–16] button.

Input Channel Layer 1–16 is selected for control from the channel strip section.

8. Press the FADER MODE [AUX1] button.

The button indicator lights up.

While the [AUX 1]–[AUX 8] button indicators are lit, faders 1–16 control the Aux 1–8 send levels.

In this example, the faders control the send level of the signals routed from Input Channels 1–16 to Aux 1 (Effects processor 1 input).

Tip: To reset the fader 1–16 function to normal mode, press the FADER MODE [HOME] button.

9. While sound is being produced on the instrument or other device, use faders 1–16 to adjust the send level of the signal sent from each Input Channel to Effect 1.

10. To adjust the effect return level, use the rotary level control located on the left side of the ST IN section on the top panel.

You can view the current level in the upper-right corner of the display.

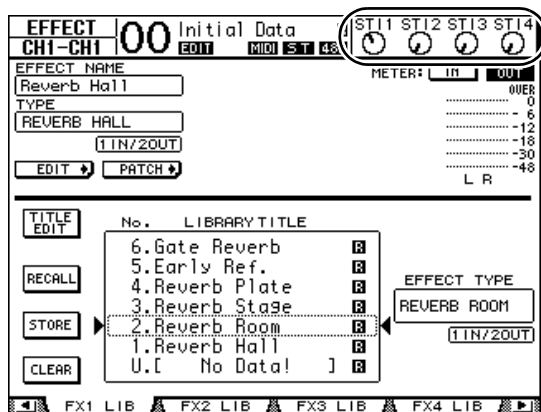

Recording to DAW Software via the USB Port

This chapter explains how the signals being input to the 01V96i can be sent via USB and be recorded into DAW software running on your computer.

Note: You must have installed the Yamaha Steinberg USB Driver on your computer. The Yamaha Steinberg USB Driver can be downloaded from the following website. For details on installation, refer to the installation guide included in the download file. <http://www.yamahaproaudio.com/>

There are two methods of recording via the USB port into DAW software on your computer.

Recording Bus Outs 1–8

In this method, the Input Channel signals are first sent to buses 1–8 and then routed to Bus Outs 1–8 and sent to USB OUT. Use this method if you want to mix the signals of multiple Input Channels and stereo-record them. If necessary, you can use the compressors and EQ of Bus Outs 1–8 to process the signals.

Here's the procedure for recording Bus Outs 1/2 via USB to a stereo track of your DAW.

Tip: The Input Channels that you want to record must be assigned to Bus Outs 1/2. For details on how to do this, refer to "Setting the Routing" on page 33.

1. Use a USB cable to connect your computer to the 01V96i.
2. Press the DISPLAY ACCESS [PATCH] button repeatedly until the Patch | USB Out page appears.

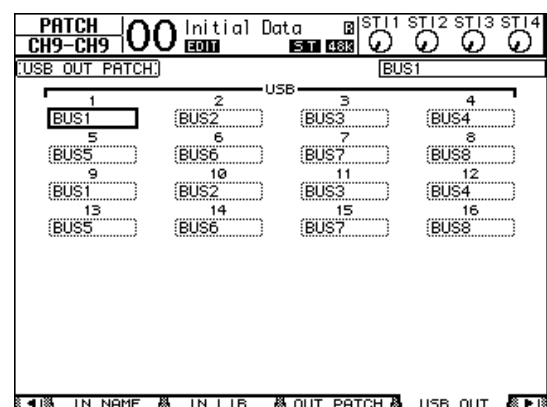

3. Make sure that USB1 is assigned to BUS1, and USB2 is assigned to BUS2.

If the settings are otherwise, use the Parameter wheel (or [INC]/[DEC]) and [ENTER] to change the settings.

4. Start up your DAW, and set it to use the Yamaha Steinberg USB Driver.

If you're using the included Cubase AI, set the following items.

- From the menu bar, choose “Devices” → “Device Settings,” then click VST Audio System. As the ASIO driver, choose “Yamaha Steinberg USB ASIO” (Windows) / “Yamaha 01V96i” (Mac).
- From the “Device” menu, choose “VST Connections.” In the Input tab choose [Add Bus], set “Configuration” to Stereo and “Number” to 1, and click [OK] to create a new stereo input. For the newly created “Stereo In,” set the device port to “01V96i 1/2” (Windows) / “01V96i 1” and “01V96i 2” (Mac).

For details on other DAW settings, refer to the owner's manual of your DAW.

5. Create a stereo track in your DAW.

6. Select 01V96i 1/2 as the input port of the stereo track.

If you're using Cubase AI, select the name of the input port that you created in step 4 (by default this will be “Stereo In”).

7. Enable recording for the track that you want to record, and start recording.

8. When you've finished recording, stop the DAW.

Recording Direct Outputs

In this method, each Input Channel is recorded directly to your DAW. Use this method if you want to record the signals of multiple Input Channels each to their own track. This is convenient when you're making a live recording that you will be mixing later. Here we'll explain the procedure for recording Input Channels 1–16 directly to DAW tracks 1–16.

1. Press the DISPLAY ACCESS [PATCH] button repeatedly until the Patch | Direct Out page appears.

2. Move the cursor to the parameter box for the Input Channels you want to route to Direct Outs, then specify the output connectors or channels.

Move the cursor to the parameter box, and use the Parameter wheel (or [INC]/[DEC]) to specify the patching. Assign 1–16 to USB1–USB16.

3. Press the DISPLAY ACCESS [PAN/ROUTING] button repeatedly until the Pan/Route | Rout1-16 page appears.

Signals of the Input Channels whose D button is turned on will be sent directly to the USB OUT that you specified in step 2.



4. Start up your DAW, and set it to use the Yamaha Steinberg USB Driver.

If you're using the included Cubase AI, set the following items.

- From the menu bar, choose “Devices” → “Device Settings,” then click VST Audio System. As the ASIO driver, choose “Yamaha Steinberg USB ASIO” (Windows) / “Yamaha 01V96i” (Mac).
- From the “Device” menu, choose “VST Connections.” In the Input tab, choose [Add Bus], set “Configuration” to Mono and “Number” to 16, and click [OK] to create sixteen new monaural inputs. For each newly created “Mono In 1–16,” set the device port to “01V96i 1–16” respectively.

For details on other DAW settings, refer to the owner's manual of your DAW.

5. Create a stereo track in your DAW.

6. Select 01V96i 1–16 respectively as the input port for each monaural track.

If you're using Cubase AI, select the name of the input ports you created in step 4 (by default these will be Mono In 1–16).

7. Enable recording for all of the tracks that you want to record, and start recording.

8. When you've finished recording, stop the DAW.

Adjusting the Monitor Levels from the DAW

The audio being played back from the DAW can be returned to the 01V96i's Input Channels and monitored via the MONITOR OUT jacks or PHONES jack. Normally, the signal of the DAW's stereo bus is sent to an 01V96i Input Channel for monitoring. However when overdubbing, you might need to monitor with a balance that's different than the mix balance of the song. In this situation, the signal from each DAW track can be returned to a separate Input Channel, and the balance adjusted on the 01V96i. Here we'll explain the procedure for sending the signals of DAW tracks 1–8 to the 01V96i's Input Channels 17–24 and adjusting the monitor levels.

1. Use a USB cable to connect your computer to the 01V96i.
2. Start up your DAW, and set it to use the Yamaha Steinberg USB Driver.

If you're using the included Cubase AI, set the following items.

- From the menu bar, choose "Devices" → "Device Settings," then click VST Audio System. As the ASIO driver, choose "Yamaha Steinberg USB ASIO" (Windows) / "Yamaha 01V96i" (Mac).
- From the "Device" menu, choose "VST Connections." In the Input tab, choose [Add Bus], set "Configuration" to Mono and "Number" to 8, and click [OK] to create sixteen new monaural inputs. For each newly created "Mono Out 1–8," set the device port to "01V96i 1–8" respectively.

For details on other DAW settings, refer to the owner's manual of your DAW.

3. In the DAW, select "01V96i 1–8" respectively as the output port of tracks 1–8.

If you're using Cubase AI, select the name of the output ports you created in step 2 (by default these will be Mono Out 1–8).

4. Press the DISPLAY ACCESS [PATCH] button repeatedly until the Patch | In Patch page appears.

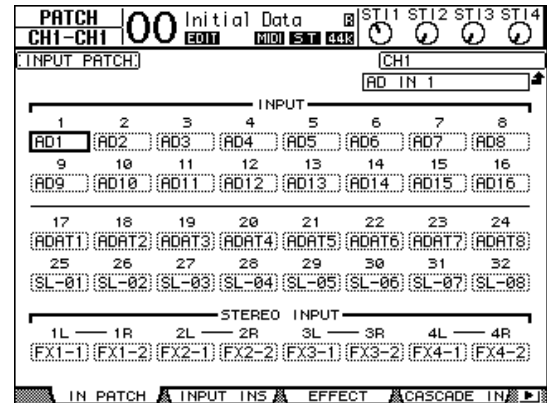

5. Move the cursor to INPUT 17–24, and use the Parameter wheel (or [INC]/[DEC]) to select USB IN 1–8 respectively.

6. Press the LAYER [17–32] button.

Input Channel Layer 17–32 is selected for control from the channel strip section.

7. Press the DISPLAY ACCESS [PAN/ROUTING] button repeatedly until the Pan/Route | Rout17-ST1 page appears.

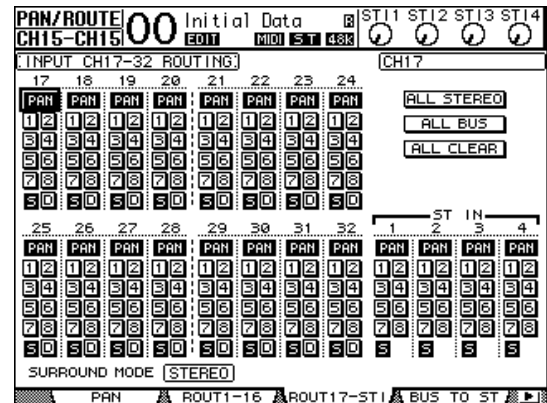

8. For each Input Channel 17–24, make sure that the S button is on and the 1–8 buttons are off, and use the PAN section to adjust the panning of the monitor signals as necessary.

Tip: Controlling Input Channel 17–32 Pan settings, faders, and the [ON] buttons will affect the monitoring signal, but will not affect the signal recorded to the DAW.

9. Press the DISPLAY ACCESS [HOME] button, then press the [F1] button to display the Meter | CH1-32 page.
10. Make sure that [ON] button indicators 1–8 are steadily lit, then raise the [STEREO] fader to 0 dB.

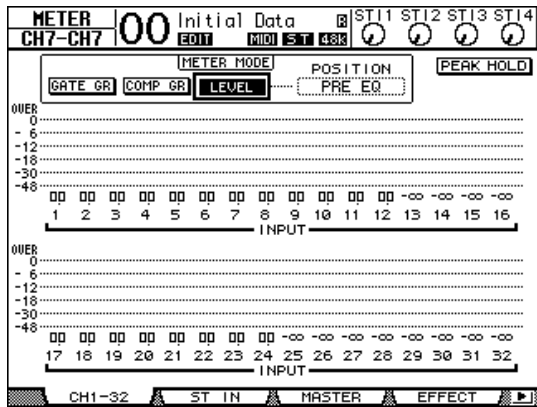

11. Play back the DAW, and adjust faders 1–8, [MONITOR OUT], and [PHONES] to set an appropriate level for the monitor signals.

Now you can monitor via the monitoring system and headphones the signals sent from Input Channels 17–24 to the Stereo Bus.

Tip: If the L & R level meters reach the “OVER” position, lower the [STEREO] fader.

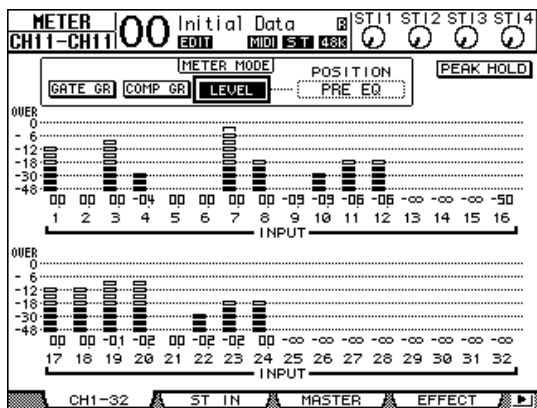

Using Scene Memories

Scene memories enable you to name and store snapshots of the 01V96i's mix parameters, internal effect processor settings, remote layers, and input/output patch settings.

You can store 99 Scene memories, and recall any Scene by using the display pages or the controls on the top panel.

Here's how to use the top panel keys to recall a Scene.

1. Adjust the mix parameters on the 01V96i to the conditions you wish to store as a Scene.
2. Press the SCENE MEMORY Up [▲] or Down [▼] buttons to select a Scene memory number.

If you select a Scene memory other than the currently-recalled Scene, its number flashes at the top of the display.

Scene memories #U (“Ud”) and #0 (“00”) are special read-only memories, to which you cannot store Scenes. Also, you cannot store Scenes to write-protected Scene memories.

3. Press the SCENE MEMORY [STORE] button.

The Title Edit window appears, which enables you to name the Scene to be stored.

4. Enter the title, move the cursor to the OK button, then press [ENTER].

The Title Edit window closes and the current Scene is stored to the selected Scene memory.

5. To recall a Scene, press the SCENE MEMORY Up [▲] or Down [▼] buttons to select a Scene memory number, then press the SCENE MEMORY [RECALL] button.

Changing the Channel Names

You can change the default name of the input channels (Input Channels 1–32, ST IN Channels 1–4) and output channels (Aux Outs 1–8, Bus Outs 1–8, Stereo Out), if you desire.

Changing the Input Channel Names

1. Press the DISPLAY ACCESS [PATCH] button repeatedly until the Patch| In Name page appears.

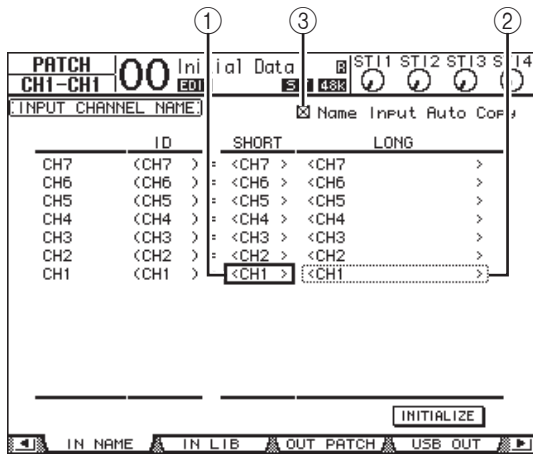

Channel IDs, Short names, and Long names are listed from left to right on the page. You can specify Short names in the parameter boxes (1) in the center column, and Long names in the parameter boxes (2) in the right column.

2. Move the cursor to the desired parameter box, then use the Parameter wheel or the [INC]/[DEC] buttons to select a port for which you want to change the name.

3. Press [ENTER].

The Title Edit window appears, which enables you to edit the name.



4. Edit the name, move the cursor to the OK button, then press [ENTER].

The new name is now effective.

Tip: The edited name is stored in the Input Patch library.

When the Name Input Auto Copy check box (3) is on, the first four characters of a newly-entered Long name are automatically copied to the Short name. On the other hand, a newly-entered Short name is automatically added to the beginning of the Long name.

You can reset all port names to their default names by moving the cursor to the INITIALIZE button, then pressing [ENTER].

Changing the Output Channel Names

To change output channel names, press the DISPLAY ACCESS [PATCH] button repeatedly until the Patch| Out Name page appears.

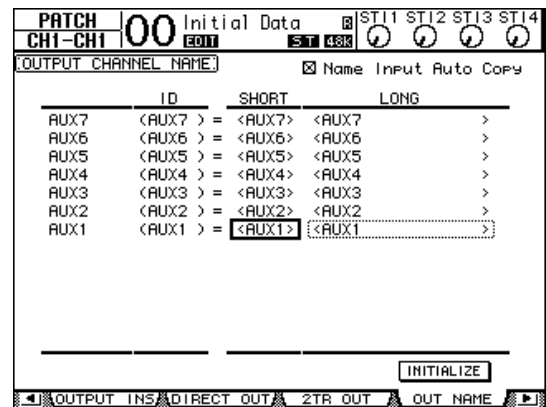

The procedure for editing the names and using the Name Input Auto Copy check box and the INITIALIZE button is the same as on the In Name page.

Creating a Custom Layer by Combining Channels (User Assignable Layer)

If you set the Remote Layer target to “USER ASSIGNABLE,” you can create a custom layer by combining any 01V96i channels (excluding the Stereo Out). This custom layer is called “User Assignable layer.”

1. Press the **DISPLAY ACCESS [DIO/SETUP]** button repeatedly until the **DIO/Setup|Remote** page appears.
2. Set the **TARGET** parameter to **USER ASSIGNABLE**, then press **[ENTER]**.
A confirmation window appears.
3. Move the cursor to the **YES** button, then press **[ENTER]**.
The 01V96i displays the page shown below.

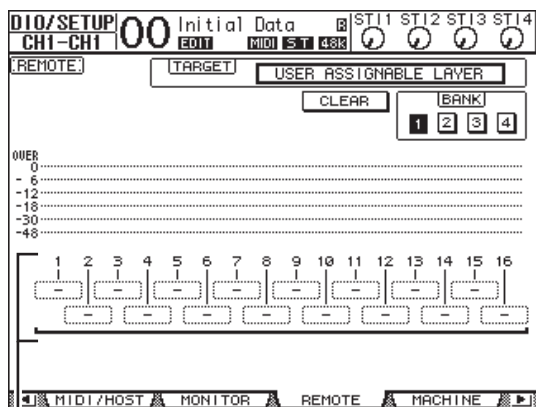

4. Select the channels you wish to assign to the User Assignable layer using the 1–16 parameter boxes (①).

You can store up to four 16-channel setups in four banks by switching Banks 1–4 via the BANK 1–4 buttons. If you press **[ENTER]** before selecting the channels to assign, you will still be able to select the channels you wish to assign in the User CH Select window.

Tip: You can reset the assignment to default by moving the cursor to the **CLEAR** button and pressing **[ENTER]**.

5. Use the **LAYER [REMOTE]** button to assign or recall the User Assignable layer.
You can use the faders and **[ON]** buttons to control the assigned channels.

Using the Oscillator

The 01V96i features an Oscillator you can use for sound checks. Follow the steps below to use the Oscillator:

1. Press the **DISPLAY ACCESS [UTILITY]** button repeatedly until the Utility | Oscillator page appears.

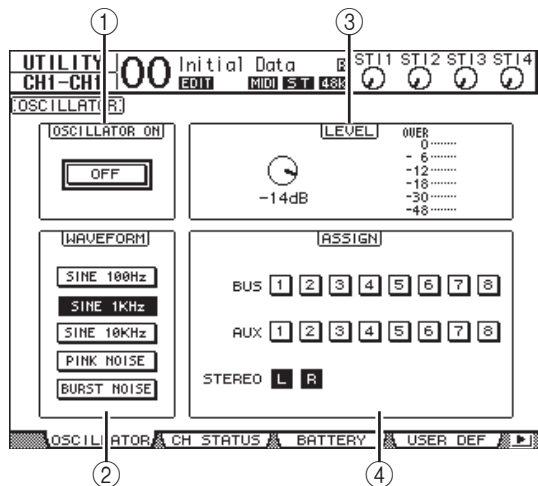

This page contains the following parameters:

1. **OSCILLATOR ON**
This parameter button turns the Oscillator on or off.
2. **WAVEFORM**
These parameter buttons select the Oscillator waveforms.
3. **LEVEL section**
The parameter control in this section sets the Oscillator output level.
4. **ASSIGN section**
The buttons in this section select the Oscillator output.

2. Move the cursor to the button for the Oscillator output channel in the **ASSIGN** section, then press **[ENTER]** (you can select multiple channels).

3. Move the cursor to one of the **WAVEFORM** parameter buttons, then press **[ENTER]**.

You can select the following waveforms:

- **SINE 100Hz**100 Hz sinewave
- **SINE 1kHz**.....1 kHz sinewave
- **SINE 10kHz**10 kHz sinewave
- **PINK NOISE**Pink noise
- **BURST NOISE** ...Burst noise (200 msec pink noise pulses at four second intervals)

4. Move the cursor to the parameter control in the **LEVEL** section, then rotate the Parameter wheel to set the Oscillator level to minimum.

Note: Sinewave and pink noise create unusually high sound pressure. Oscillator levels that are too high can damage the speakers. When you use the Oscillator, be sure to set the level to minimum, then raise the level gradually.

5. Move the cursor to the **OSCILLATOR ON/OFF** button, then press the **[ENTER]** or **[INC]/[DEC]** buttons to turn on the Oscillator.

The Oscillator signal is now routed to the channels selected in the **ASSIGN** section.

6. Move the cursor to the parameter control in the **LEVEL** section, then rotate the Parameter wheel to raise the Oscillator level.

You can view the current Oscillator level on the **LEVEL** meter.

Using the User Defined Keys

You can assign any of more than 160 functions to the USER DEFINED KEYS [1]–[8] buttons.

If you assign to one of the buttons (or “keys”) a function that is usually executed on the display pages, you can use the assigned button as a shortcut.

The Function to User Defined Keys assignments are stored in banks. Each bank accommodates an assignment of all eight buttons. The 01V96i provides eight banks (Banks A–H). Switching banks enables you to change the assignment quickly.

Follow the steps below to assign functions to the USER DEFINED KEYS.

1. Press the USER ACCESS [UTILITY] button to locate the Utility | User Def page.

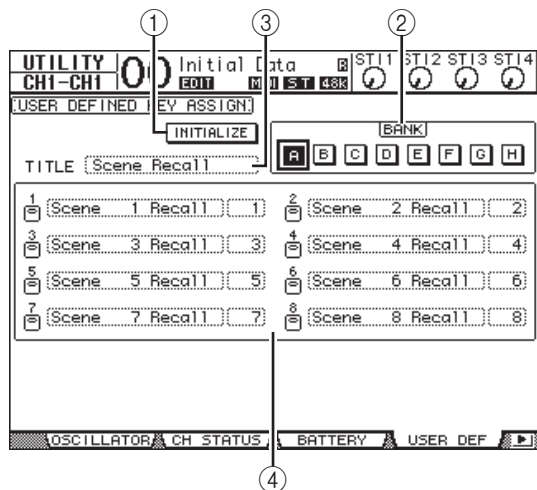

This page contains the following parameters:

- ① **INITIALIZE**
This button resets the contents of all banks to their initial settings.
- ② **BANK**
These buttons select the desired banks.
- ③ **TITLE**
This parameter displays the name of the bank selected by the BANK parameter button. Move the cursor to the TITLE parameter box, then press [ENTER]. The Title Edit window appears, enabling you to enter a name.
- ④ **1–8**
These parameter boxes enable you to assign functions to USER DEFINED KEYS [1]–[8].

2. Move the cursor to the desired BANK parameter button, then press [ENTER].

The corresponding bank is selected, and the functions assigned to the User Defined buttons in that bank are displayed in the 1–8 parameter boxes.

Tip: When you select a function that is executed based on specified numbers (for example, a function that recalls a specific Scene or library memory or transmits MIDI messages), an extra parameter box appears on the right, in which you must specify the number.

3. Move the cursor to one of the 1–8 parameter boxes, then press [ENTER].

The 01V96i displays the User Define Select window, which enables you to assign functions to the selected buttons.

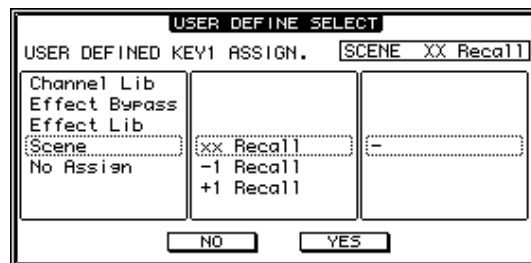

4. Move the cursor to the left column, then rotate the Parameter wheel or press the [INC]/[DEC] buttons to select a function you wish to assign.

A function is selected when it appears inside the dotted box. See the Reference Manual for a complete list of assignable functions.

5. In the same way, set the center and right column.

The items that appear in the center and right columns vary depending on the function selected in Step 4.

6. To close the window, move the cursor to the YES button, then press [ENTER].

When the window closes, the specified function is assigned to the selected User Defined button.

To cancel the assignment, move the cursor to the CANCEL button, then press [ENTER].

7. If you assigned functions that require numbers (such as recalling a Scene or library memory), move the cursor to the extra parameter box shown on the right and specify the number.

Tip: The 01V96i's settings can be saved on the hard disk of your computer by using Studio Manager software. We strongly recommend that you back up important data. Studio Manager can be downloaded from the following website.
<http://www.yamahaproaudio.com/>

Using Operation Lock

The 01V96i features an Operation Lock function that prevents unintentional edits and restricts access to panel operation with a password.

To use the Operation Lock function, press the [UTILITY] button repeatedly to display the Utility | Lock page.

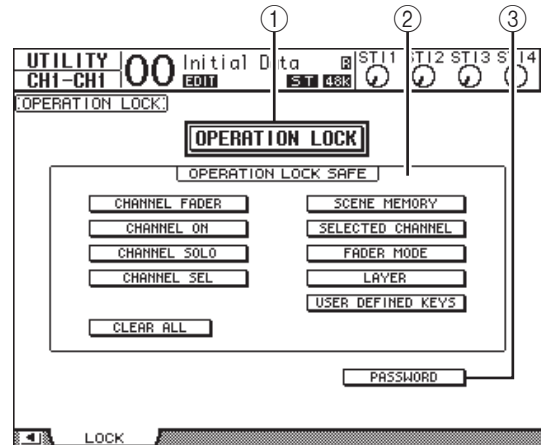

This page contains the following parameters:

① OPERATION LOCK

This button enables or cancels Operation Lock. When you turn on this button, the Password window appears.



Enter a four-letter password using the Channel 1–10 [SEL] buttons (Channel 10 [SEL] button enters “0”). (The password characters are represented by asterisks.) Move the cursor to the OK button, then press [ENTER] to enable Operation Lock. The factory default password is “1234.”

To cancel Operation Lock, press [ENTER]. The Password window appears again. Enter the password and select the OK button. Operation Lock is cancelled.

Note: If you forget the password, you cannot cancel Operation Lock. Be sure to write down the password.

② OPERATION LOCK SAFE section

This section enables you to select certain controls on the panel to exclude from Operation Lock. To cancel all “safe” buttons simultaneously, move the cursor to the CLEAR ALL button, then press [ENTER].

③ PASSWORD

This button enables you to change the current password. Move the cursor to the PASSWORD button, then press [ENTER]. The Set Password window appears, enabling you to change the password.



Enter the current password in the PASSWORD field, and a new password in the NEW PASSWORD field. The factory default password is “1234.” Enter the new password again in the REENTRY field located below the NEW PASSWORD field. Move the cursor to the OK button, then press [ENTER] to change the password.

Tip: To clear the registered password, move the cursor to the CLEAR button, then press [ENTER]. If you've forgotten the password you specified, you can clear the password by initializing the 01V96i to its factory-set state.

Initializing

You can delete all currently-recorded settings and restore the factory-preset values, and reset the Operation Lock password to its initial setting. Follow the steps below.

Note:

- If you initialize the 01V96i to the factory-preset values, all Scene, library and other data you stored previously will be erased. Proceed with caution.
- If you want to keep the current internal data, be sure to first back up the data using the Studio Manager software.

1. Make sure that the power to the 01V96i is turned off.
2. While holding down the SCENE MEMORY [STORE] button, turn on the POWER ON/OFF switch.

After a moment, the 01V96i displays the following confirmation window.

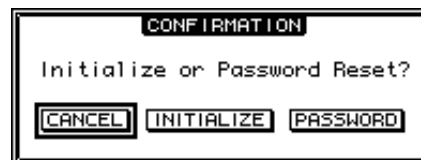

3. To reset the 01V96i to factory default settings, move the cursor to the INITIALIZE button, then press [ENTER].

To cancel the initialization operation, move the cursor to the CANCEL button, then press [ENTER].

When the internal data is thoroughly overwritten, the 01V96i restarts using the factory settings.

4. To reset the Operation Lock password to its initial setting, in Step 2, move the cursor to the PASSWORD button, then press [ENTER].

The password is reset to “1234.”

If you do not take any action after the confirmation window appears, the window automatically closes and the 01V96i restarts without being initialized.

Troubleshooting

Power won't turn on, panel LEDs or LCD won't light	<ul style="list-style-type: none"> ○ Are the LCD contrast and panel brightness set appropriately? ○ Is the POWER switch turned on? ○ If the power still does not turn on, contact a Yamaha service center listed at the end of the manual.
Sound is not input	<ul style="list-style-type: none"> ○ Is the optional I/O card inserted correctly? (see page 18) ○ Is the signal from the external device being input? ○ Is the input port patched to an input channel? (see page 29) ○ Is the GAIN set to an appropriate level? (see page 32) ○ Is the EQ attenuator raised? (see page 35) ○ Is an insert turned on even though it is not assigned correctly? ○ Is the input channel's [ON] key indicator lit? ○ Is the input channel's fader raised?
Sound is not output	<ul style="list-style-type: none"> ○ Is the optional I/O card inserted correctly? (see page 18) ○ Is the STEREO channel's [ON] key indicator lit? ○ Is the output channel patched to an output port? (see page 31)
Sound is not output from headphones or MONITOR OUT jacks	<ul style="list-style-type: none"> ○ Is the [PHONES] knob or [LEVEL] knob set to an appropriate volume?
Insufficient volume	<ul style="list-style-type: none"> ○ Is the GAIN set to an appropriate level? (see page 32) ○ Is the input channel's fader raised? ○ Could the EQ gain be lowered excessively? (see page 35) ○ Could the GATE/COMP threshold or ratio be set to an excessive value? (see page 37) ○ Is the EQ attenuator raised? (see page 35) ○ Is the output channel's fader raised? ○ Check the levels in each screen of the METER function. (see page 23)
Sound is distorted	<ul style="list-style-type: none"> ○ Is the wordclock set correctly? (see page 27) ○ Is the GAIN set to an appropriate level? (see page 32) ○ Could the input channel's fader be raised excessively? ○ Could the STEREO channel's fader be raised excessively? ○ Could the EQ or COMP gain be raised excessively? (see pages 35–37)
Sound is output even though not patched to an output channel	<ul style="list-style-type: none"> ○ Could the input channel be set to direct out? (see page 33) ○ Could insert out be assigned to the output channel?
Operating a fader does not change the level as expected	<ul style="list-style-type: none"> ○ Are the correct channels selected in the LAYER section?
Only a specific channel is heard from the MONITOR OUT or PHONES jack	<ul style="list-style-type: none"> ○ Could the [CUE] key be on?
Noise is present in an externally connected recorder or device	<ul style="list-style-type: none"> ○ Is the wordclock set correctly? (see page 27) ○ Could an unsynchronized signal be input? ○ Is the oscillator turned on? (see page 45)
High-frequency range is lacking	<ul style="list-style-type: none"> ○ Could emphasis be applied? This will occur if the state of the input signal does not match the emphasis data. ○ Could EQ be applied? (see page 35)
An input signal is being input, but there's no monitor output	<ul style="list-style-type: none"> ○ Could DIMMER be applied? ○ Is the routing appropriate for the signal you want to monitor?
Headroom is restricted, particularly when EQ boost is applied	<ul style="list-style-type: none"> ○ Use the EQ's attenuator to reduce the level. (see page 35)
Signal is delayed	<ul style="list-style-type: none"> ○ Check whether the delay of each channel is set correctly.
Can't save scene memories or library data	<ul style="list-style-type: none"> ○ Could you be attempting to save a read-only scene/library memory, or a protected scene? (see page 42)
Can't transmit/receive MIDI data	<ul style="list-style-type: none"> ○ Is the MIDI PORT selected correctly? ○ Are the MODE and channel selected correctly on the transmitting and receiving devices? ○ Have you assigned an event to the program change?
When a scene is recalled, some channels/parameters do not update	<ul style="list-style-type: none"> ○ Could recall safe be specified for those channels/parameters?
When a scene is recalled, it takes time for the faders to stop	<ul style="list-style-type: none"> ○ Could a fade time have been specified?

<p>Signal level is low at a specific frequency</p>	<ul style="list-style-type: none"> ○ Could the EQ gain be excessively low? ○ Routing a signal through GEQ or an effect will delay it relative to other signals. If a signal is mixed with the same signal routed differently, a comb filter effect will decrease the level at specific frequencies.
<p>Can't control the 01V96i console from 01V96i Editor</p>	<ul style="list-style-type: none"> ○ Refer to the 01V96i Editor installation guide on the website.
<p>The 01V96i console is not recognized by your DAW software</p>	<ul style="list-style-type: none"> ○ Have you downloaded and installed the Yamaha Steinberg USB Driver? ○ You must connect the 01V96i to the computer and power-on the 01V96i before you start up your DAW software. ○ Check the driver settings and device settings of your DAW software.
<p>Signals are not recorded on your DAW software</p>	<ul style="list-style-type: none"> ○ Are the input ports set appropriately on your DAW software? ○ If you're using Cubase, are the VST connection settings appropriate? ○ Is the signal you want to record being routed to one of USB1–16?

Error messages

Message	Summary
Memory backup issues	
Check Sum Error!	Check sum did not match between shutdown and startup. A memory backup problem has occurred, perhaps because the battery is low.
Low Battery!	The backup battery has run low. Replace the battery.
Low Battery ! Replace Battery !	The battery is low. Replace the battery.
Low Battery ! Factory Preset ? Replace Battery !	The battery is low. Replace the battery.
Battery is Exhausted ! Replace Battery !	The battery is dead. Replace the battery.
Communication issues	
MIDI port is not selected!	This will appear if you attempt to execute a bulk dump with the MIDI PORT unspecified.
Port busy. Try again.	Port Busy occurred while executing a MIDI bulk dump. Try the operation once again.
TX buffer full. Try again.	TX Buffer Full occurred while executing a MIDI bulk dump. Try the operation once again.
Work Memory full!	Memory could not be allocated for the MIDI bulk dump.
MIDI Framing Error	There was a framing error in the message received at the MIDI port. Check whether an appropriate device is connected.
MIDI Overrun Error	There was an overrun error in the message received at the MIDI port. Check whether an appropriate device is connected.
MIDI Parity Error	There was a parity error in the message received at the MIDI port. Check whether an appropriate device is connected.
MIDI RxBuf. Full	The MIDI port reception buffer has overflowed. Cause: The amount of data being received is too great, or the system has been loaded for an extended period of time.
MIDI TxBuf. Full	The MIDI port transmission buffer has overflowed. Cause: The amount of data being transmitted is too great, or the system has been loaded for an extended period of time.
SLOT1 Framing Error	There was a framing error in the message received at the SLOT1 serial port. Check the serial bridge settings of the MY card.
SLOT1 Overrun Error	There was an overrun error in the message received at the SLOT1 serial port. Check the serial bridge settings of the MY card.
SLOT1 Parity Error	There was a parity error in the message received at the SLOT1 serial port. Check the serial bridge settings of the MY card.
SLOT1 RxBuf. Full	The SLOT1 serial port reception buffer has overflowed. Cause: The amount of data being received was too great, or the system has been loaded for an extended period of time.
SLOT1 TxBuf. Full	The SLOT1 serial port transmission buffer has overflowed. Cause: The amount of data being transmitted was too great, or the system has been loaded for an extended period of time.
USB RxBuf. Full	The USB port reception buffer has overflowed. Cause: The amount of data being received was too great, or the system has been loaded for an extended period of time.
USB TxBuf. Full	The USB port transmission buffer has overflowed. Cause: The application on the communicating PC terminated abnormally, etc. Disconnect and reconnect the cable, and restart the application.

Message	Summary
DIO issues	
WRONG WORD CLOCK!	The wordclock is incorrect. Cause: The device assigned as the clock source is not running, or a clock source to which the 01V96i cannot synchronize has been selected.
Sync Error!(SLOT)	Synchronization has not been achieved with the input signal from the MY slot. Check the clock source of the connected device.
Sync Error!(2TRD)	Synchronization has not been achieved with the 2TR Digital input signal. Check the clock source of the connected device.
Sync Error!(ADAT IN)	Synchronization has not been achieved with the ADAT IN input signal. Check the clock source of the connected device.
Memory store/recall issues	
Y56K Couldn't Store #xx : SLOT(1).	The Y56K/Y96K's scene #xx could not be stored. Cause: You selected scene 97 or later.
Y56K Couldn't Recall #xx : SLOT(1).	The Y56K/Y96K's scene #xx could not be recalled. Cause: The scene had not been stored in the Y56K/Y96K, or you selected scene 97 or later.
Channel Library #xx Can't Recall!	This message appears if you attempt to recall a channel library memory that was created from a different channel module. For example, this will appear if a library memory created for an Aux channel is recalled to an Input channel.
Nothing to Undo!	Undo is not possible because there is no data in the undo buffer. This message will appear if you attempt to recall the undo buffer (#U) without having executed Store or Recall since the console was powered-on.
Nothing to Paste.	The copy buffer is empty. This message will appear if you attempt to execute Channel Paste before executing Channel Copy.
Can't Paste to a Different Channel Type.	You cannot Paste because the channel module is different. For example, this message will appear if you copy INPUT Channel 1 and attempt to paste it to AUX1.
For Effect 1,2 Only.	This effect type can be used only with EFFECT 1 and 2. This message will appear if you attempt to recall HQ.PITCH or FREEZE to EFFECT 3 or 4.
AUX Pair Status Conflicted!	This message will appear if the saved CH Library memory and AUX have different Pair settings. The library memory has been recalled, but the Pair settings for AUX have not been reproduced.
Surround Mode Conflicted!	This message will appear if the channel library memory and the Surround Mode settings are different. The library memory has been recalled, but the AUX pair settings have not been reproduced.
Output Has No Gate!	This message will appear if you attempt to recall a Gate library memory to an Output.
Stereo In Has No Gate!	This message will appear if you attempt to recall a Gate library memory to a Stereo In.
Stereo In Has No Comp!	This message will appear if you attempt to recall a Comp library memory to a Stereo In.
#xx of Scene is Read Only! #xx of Channel Library is Read Only! #xx of Gate Library is Read Only! #xx of Comp Library is Read Only! #xx of EQ Library is Read Only! #xx of Effects Library is Read Only! #xx of Input Patch Library is Read Only! #xx of Output Patch Library is Read Only!	This message will appear if you attempt to execute an operation such as Store or Title Edit on a read-only memory.
#xx of Scene is Protected!	This message will appear if you attempt to execute an operation such as Store or Title Edit on a protected scene.
#xx of Scene is Empty! #xx of Channel Library is Empty! #xx of Gate Library is Empty! #xx of Comp Library is Empty! #xx of EQ Library is Empty! #xx of Effects Library is Empty! #xx of Input Patch Library is Empty! #xx of Output Patch Library is Empty!	This message will appear if you attempt to recall a scene or library memory in which no data has been saved

Message	Summary
Panel operation	
Not assigned.	This message will appear if you operate a user-defined key to which no function has been assigned.
This Key doesn't Work on Current Layer.	This message will appear if you operate a key that is non-functional when using a remote layer whose target setting is ProTools, Nuendo, Cubase, or General DAW.
Fader calibration data error! Channel xx,yy,...	A data error has occurred for channel xx,yy,... fader calibration. Please execute fader calibration. If this does not solve the problem, please contact a service center.
Patch issues	
Currently Patched from Direct Out!	This message will appear if you attempt to change the output patching of an output port that is assigned to Direct Out while using Direct Out.
This Routing is Ineffective!	Sound will not be output because an invalid Direct Out Patch has been specified. This message will appear if you turn on a Direct Out that is patched to an output port corresponding to the even-numbered channel of a double channel when operating at 88.2 kHz or 96 kHz.

Contents of the Reference Manual

How to Use This Reference Manual	1	Internal Effects	64
Contents of the Owner's Manual (Booklet)	3	About the Internal Effects	64
Function Tree	4	Using Effects Processors via Aux Sends	64
Control Surface & Rear Panel	6	Inserting the Internal Effects into Channels	65
Control Surface	6	Editing Effects	66
Rear Panel	10	About Add-On Effects	67
Analog I/O & Digital I/O	12	About Plug-Ins	67
Analog Inputs & Outputs	12	Scene Memories	68
Digital Inputs & Outputs	13	About Scene Memories	68
Converting Sampling Rates of Signals Received at I/O Card Inputs ..	14	What is Stored in a Scene?	68
Monitoring Digital Input Channel Status	14	About Scene Numbers	68
Dithering Digital Outputs	15	Storing and Recalling Scenes	69
Setting the Transfer Format for Higher Sampling Rates	16	Auto Scene Memory Update	70
Input Channels	17	Fading Scenes	71
About Input Channels	17	Recalling Scenes Safely	72
Setting the Input Channels from the Display	18	Sorting Scenes	72
Setting the Input Channels from the Control Surface	25	Copying and Pasting a Scene (Global Paste)	73
Pairing Input Channels	26	Libraries	74
Naming Input Channels	28	About the Libraries	74
Bus Outs	29	General Library Operation	74
About Stereo Out	29	Using Libraries	75
Bus Out 1–8	29	Remote Control	83
Setting the Stereo Out and Bus Out 1–8 from the Display	30	About Remote Function	83
Setting the Stereo Out and Bus Out 1–8 from the Control Surface	33	Pro Tools Remote Layer	83
Pairing Buses or Aux Sends	33	Nuendo/Cubase Remote Layer	93
Attenuating Output Signals	34	Other DAW Remote Layer	94
Naming the Stereo Out and Bus Outs	35	MIDI Remote Layer	94
Aux Outs	36	Machine Control Function	98
Aux Out 1–8	36	MIDI	100
Setting Aux Out 1–8 from the Display	36	MIDI & the 01V96i	100
Setting Aux Out 1–8 from the Control Surface	38	MIDI Port Setup	101
Setting Aux Send Levels	38	Assigning Scenes to Program Changes for Remote Recall	103
Viewing Aux Send Settings for Multiple Channels	40	Assigning Parameters to Control Changes for Real-time Control ..	104
Panning Aux Sends	41	Controlling Parameters by Using Parameter Changes	106
Copying Channel Fader Positions to Aux Sends	42	Transmitting Parameter Settings via MIDI (Bulk Dump)	107
Input & Output Patching	43	Other Functions	109
Input Patching	43	Setting Preferences	109
Output Patching	44	Creating a Custom Layer by Combining Channels (User Assignable Layer)	110
Patching Direct Outs	46	Cascading Consoles	111
Insert Patching	47	Checking the Battery and the System Version	113
Monitoring	49	Calibrating the Faders	113
Monitor	49	Index	115
Monitor and Solo Setup	49	Appendix: Parameter Lists	119
Using the Monitor	50	USER DEFINED KEYS	119
Using the Solo Function	51	USER DEFINED KEYS Initial Assignments	121
Surround Pan	52	Input Patch Parameters	121
About Surround Pan	52	Initial Input Patch Settings	123
Setting Up and Selecting Surround Pan Modes	53	Output Patch Parameters	125
Surround Panning	56	Initial Output Patch Settings	127
Grouping Channels & Linking Parameters	59	User Defined Remote Layer Initial Bank Settings	128
Grouping & Linking	59	Effects Parameters	132
Using Fader Groups and Mute Groups	59	Effects and tempo synchronization	146
Using Fader Group Master	61	Preset EQ Parameters	147
Using Mute Group Master	62	Preset Gate Parameters (fs = 44.1 kHz)	148
Linking EQ and Compressor Parameters	62	Preset Compressor Parameters (fs = 44.1 kHz)	149
		Dynamics Parameters	151
		Appendix: MIDI	156
		Scene Memory to Program Change Table	156
		Initial Parameter to Control Change Table	157
		MIDI Data Format	173
		MIDI Implementation Chart	End of Manual

Specifications

General Spec

Number of scene memories		99	
Sampling Frequency	Internal	44.1 kHz, 48 kHz, 88.2 kHz, 96 kHz	
	External	USB audio Normal Rate 44.1 kHz \pm 0.1% 48 kHz \pm 0.1% Double Rate 88.2 kHz \pm 0.1% 96 kHz \pm 0.1%	
		The others Normal rate: 44.1 kHz-10% to 48 kHz+6% Double rate: 88.2 kHz-10% to 96 kHz+6%	
Signal Delay	fs=48 kHz	Less than 1.6 ms CH INPUT to STEREO OUT	
	fs=96 kHz	Less than 0.8 ms CH INPUT to STEREO OUT	
Fader		100 mm motorized \times 17	
Fader Resolution		+10 to -138, $-\infty$ dB input faders	
		0 to -138, $-\infty$ dB master faders, stereo fader	
Total Harmonic Distortion ¹ (CH INPUT to STEREO OUT) (Input Gain=Min.)	fs=48 kHz	Less than 0.05% 20 Hz-20 kHz @ +14 dB into 600 Ω Less than 0.01% 1 kHz @ +24 dB into 600 Ω	
	fs=96 kHz	Less than 0.05% 20 Hz-40 kHz @ +14 dB into 600 Ω Less than 0.01% 1 kHz @ +24 dB into 600 Ω	
Frequency Response (CH INPUT to STEREO OUT)	fs=48 kHz	20 Hz-20 kHz, 0.5, -1.5 dB @ +4 dB into 600 Ω	
	fs=96 kHz	20 Hz-40 kHz, 0.5, -1.5 dB @ +4 dB into 600 Ω	
Dynamic Range (maximum level to noise level)		110 dB typ. DA Converter (STEREO OUT)	
		105 dB typ. AD+DA (to STEREO OUT) @ fs=48 kHz	
		105 dB typ. AD+DA (to STEREO OUT) @ fs=96 kHz	
Hum & Noise ² (20 Hz-20 kHz) Rs=150 Ω		-128 dB Equivalent Input Noise	
		-86 dB residual output noise. STEREO OUT (STEREO OUT off)	
		Input Gain=Max. Input Pad=0 dB	-86 dB (90 dB S/N) STEREO OUT (STEREO fader at nominal level and all CH INPUT faders at minimum level)
		Input Pad=0 dB Input Sensitivity =-60 dB	-64 dB (68 dB S/N) STEREO OUT (STEREO fader at nominal level and one CH INPUT fader at nominal level)
Maximum Voltage Gain		74 dB CH INPUT (CH1-12) to STEREO OUT/OMNI (BUS) OUT	
		40 dB CH INPUT (CH13-16) to STEREO OUT	
		74 dB CH INPUT (CH1-12) to OMNI (AUX) OUT (via pre input fader)	
		74 dB CH INPUT (CH1-12) to MONITOR OUT (via STEREO BUS)	
Crosstalk (@ 1 kHz) Input Gain=Min.		80 dB adjacent input channels (CH1-12)	
		80 dB adjacent input channels (CH13-16)	
		80 dB input to output	
AD Input (1-12)	Phantom switch	+48 V DC (each 4ch)	
	Pad switch	0/20 dB attenuation	
	Gain control	44 dB (-60 to -16), detented	
	Peak indicator	LED (red) turns on when post HA level reaches 3 dB below clipping at digital domain	
	Signal indicator	LED (green) turns on when post HA level reaches 20 dB below nominal at digital domain	
	AD converter	24-bit linear, 128-times oversampling (fs=44.1, 48 kHz), 64-times oversampling (fs=88.2, 96 kHz)	

AD Input (13–16)	Gain control	30 dB (–26 to +4), detented
	Peak indicator	LED (red) turns on when post HA level reaches 3 dB below clipping at digital domain
	Signal indicator	LED (green) turns on when post HA level reaches 20 dB below nominal at digital domain
	AD converter	24-bit linear, 128-times oversampling (fs=44.1, 48 kHz), 64-times oversampling (fs=88.2, 96 kHz)
	Input selector	CH15/16/2TR IN for CH15/16
Digital Input (2TR IN DIGITAL, ADAT input)		
Option Input (SLOT)	Available cards	Optional digital interface cards (MY16, MY8, MY4 series)
Input Channel CH1–32	Input patch	—
	Phase	Normal/reverse
	Gate-type³	On/off
		Key in: 12 ch Group (1–12, 13–24, 25–32)/AUX1–8
	Comp-type⁴	On/off
		Key in: self /Stereo Link
		Pre EQ/pre fader/post fader
	Attenuator	–96.0 to +12.0 dB (0.1 dB step)
	EQ	4-band PEQ (TYPE1) ⁵
		On/off
	Delay	0–43400 samples
	On/off	—
	Fader	100 mm motorized (INPUT/AUX1–8)
	Aux send	On/off
		AUX1–8; pre fader/post fader
	Solo	On/off
		Pre fader/after pan
	Pan	127 positions (Left= 1–63, Center, Right= 1–63)
	Surround pan	127 × 127 positions ([Left= 1–63, Center, Right= 1–63] × [Front= 1–63, Center, Rear= 1–63])
	LFE level	–∞, –96 dB to +10 dB (256 step)
Routing	STEREO, BUS1–8, DIRECT OUT	
Direct out	Pre EQ/pre fader/post fader	
Metering	Displayed on LCD	
	Peak hold on/off	
Stereo Input Channel CH1–4	Input patch (L/R)	—
	Phase (L/R)	Normal/reverse
	Attenuator (L/R)	–96.0 to +12.0 dB (0.1 dB step)
	Equalizer	4band PEQ (TYPE1) ⁵
	On/off	—
	Fader	100 mm motorized
		INPUT/AUX1–8 send
	Aux send	On/off
		AUX1–8; pre fader/post fader
	Solo	On/off
		Pre fader/after pan
	Pan (L/R)	127 positions (Left= 1–63, Center, Right= 1–63)
	Surround pan (L/R)	127 × 127 positions ([Left= 1–63, Center, Right= 1–63] × [Front= 1–63, Center, Rear= 1–63])
	LFE level (L/R)	–∞, –96 dB to +10 dB (256 step)
	Routing	STEREO, BUS1–8, DIRECT OUT
	Metering	Displayed on LCD
Peak hold on/off		

OSCILLATOR	Level	0 to -96 dB (1 dB step)
	On/off	—
	Waveform	Sine 100 Hz, sine 1 kHz, sine 10 kHz, pink noise, burst noise
	Routing	BUS1-8, AUX1-8, STEREO L/R
STEREO OUT	DA converter	24-bit linear, 128-times oversampling (@fs=44.1, 48 kHz), 64-times oversampling (@fs=88.2, 96 kHz)
MONITOR OUT	DA converter	24-bit linear, 128-times oversampling (@fs=44.1, 48 kHz), 64-times oversampling (@fs=88.2, 96 kHz)
OMNI OUT 1-4	Output patch	STEREO, BUS1-8, AUX1-8, DIRECT OUT 1-32, INSERT OUT (CH1-32, BUS1-8, AUX1-8, STEREO), CASCADE OUT (BUS1-8, AUX 1-8, STEREO, SOLO)
	DA converter	24-bit linear, 128-times oversampling (@fs=44.1, 48 kHz), 64-times oversampling (@fs=88.2, 96 kHz)
2TR OUT DIGITAL	Dither	On/off Word length 16, 20, 24-bit
	Output patch	STEREO, BUS1-8, AUX 1-8, DIRECT OUT 1-32, INSERT OUT (CH 1-32, BUS 1-8, AUX 1-8, STEREO), CASCADE OUT (BUS 1-8, AUX 1-8, STEREO, SOLO)
ADAT Output	Dither	On/off Word length 16, 20, 24-bit
	Output patch	STEREO, BUS1-8, AUX 1-8, DIRECT OUT 1-32, INSERT OUT (CH 1-32, BUS 1-8, AUX 1-8, STEREO), CASCADE OUT (BUS 1-8, AUX 1-8, STEREO, SOLO)
Option Output (SLOT)	Available card	Optional digital interface card (MY16, MY8, MY4 series)
	Dither	On/off Word length 16/20/24-bit
	Output patch	STEREO, BUS1-8, AUX 1-8, DIRECT OUT 1-32, INSERT OUT (CH 1-32, BUS 1-8, AUX 1-8, STEREO), CASCADE OUT (BUS 1-8, AUX 1-8, STEREO, SOLO)
STEREO	Comp-type ⁴	On/off
		Pre EQ/pre fader/post fader
	Attenuator	-96.0 to +12.0 dB (0.1 dB step)
	EQ	4-band PEQ ⁵
		On/off
	On/off	—
	Fader	100 mm motorized
	Balance	127 positions (Left=1-63, Center, Right=1-63)
Delay	0-29100 samples	
Metering	Displayed on LCD	
	Peak hold on/off	
	12-elements x2 LED meters	
BUS1-8	Comp-type ⁴	On/off
		Pre EQ/pre fader/post fader
	Attenuator	-96.0 to +12.0 dB (0.1 dB step)
	EQ	4-band PEQ ⁵
		On/off
	On/off	—
	Fader	100 mm motorized
	Delay	0-29100 samples
	Bus to stereo	Level (-∞, -138 dB-0 dB)
		On/off
		Pan: 127 positions (Left=1-63, Center, Right=1-63)
Metering	Displayed on LCD	
	Peak hold on/off	

AUX1-8	Comp-type ⁴	On/off
		Pre EQ/pre fader/post fader
	Attenuator	-96.0 to +12.0 dB (0.1 dB step)
	EQ	4-band PEQ ⁵
		On/off
	On/off	—
	Fader	100 mm motorized
Delay	0-29100 samples	
Metering	Displayed on LCD	
	Peak hold on/off	
INTERNAL EFFECTS (EFFECT 1-4)	Number of effects	4@44.1 kHz, 48kHz
		2@88.2kHz, 96kHz
	Bypass	On/off
	In/out	2-in, 2-out
	Effect-in from	AUX1-8/INSERT OUT
Effect-out to	Input patch	
Power Requirements	U.S./Canada	120 V, 60 Hz 90 W
	Other	220-240 V, 50/60 Hz 90 W
Dimensions	(H x D x W)	148 x 548 x 436 mm
Weight (without the included items)		14 kg
Operating free-air temperature range		0-35°C
Storage temperature range		-20 to 60°C
Supplied Accessories		AC Cable CD-ROM (Reference Manual) DVD-ROM (DAW Software) Owner's Manual
Options		Digital interface card (MY16, MY8, MY4 series) RACK MOUNT KIT: RK1

1. Total harmonic distortion is measured with a 6 dB/octave filter @ 80 kHz.
2. Hum & Noise are measured with a 6 dB/octave filter @ 12.7 kHz; equivalent to a 20 kHz filter with infinite dB/octave attenuation.
3. See "Gate Parameters" on page 59.
4. See "Comp Parameters" on page 60.
5. See "EQ Parameters" on page 59.

EQ Parameters

	LOW/HPF	L-MID	H-MID	HIGH /LPF
Q	0.1–10.0 (41 points) low shelving HPF	0.1–10.0 (41 points)		0.1–10.0 (41 points) high shelving LPF
F	21.2 Hz–20.0 kHz (1/12 oct step)			
G	±18 dB (0.1 dB step) HPF: on/off	±18 dB (0.1 dB step)		±18 dB (0.1 dB step) LPF: on/off

Gate Parameters

Gate	Threshold	–54 dB–0 dB (0.1 dB step)
	Range	–70 dB–0 dB (1 dB step)
	Attack	0 ms–120 ms (1 ms step)
	Hold	0.02 ms–1.96 s (216 points) @ 48 kHz
		0.02 ms–2.13 s (216 points) @ 44.1 kHz
		0.01 ms–981 ms (216 points) @ 96 kHz
		0.01 ms–1.06 s (216 points) @ 88.2 kHz
	Decay	5 ms–42.3 s (160 points) @ 48 kHz
		6 ms–46.0 s (160 points) @ 44.1 kHz
		3 ms–21.1 s (160 points) @ 96 kHz
3 ms–23.0 s (160 points) @ 88.2 kHz		
Ducking	Threshold	–54 dB–0 dB (0.1 dB step)
	Range	–70 dB–0 dB (1 dB step)
	Attack	0 ms–120 ms (1 ms step)
	Hold	0.02 ms–1.96 s (216 points) @ 48 kHz
		0.02 ms–2.13 s (216 points) @ 44.1 kHz
		0.01 ms–981 ms (216 points) @ 96 kHz
		0.01 ms–1.06 s (216 points) @ 88.2 kHz
	Decay	5 ms–42.3 s (160 points) @ 48 kHz
		6 ms–46.0 s (160 points) @ 44.1 kHz
		3 ms–21.1 s (160 points) @ 96 kHz
3 ms–23.0 s (160 points) @ 88.2 kHz		

Comp Parameters

Compressor	Threshold	-54 dB–0 dB (0.1 dB step)
	Ratio (x :1)	x=1, 1.1, 1.3, 1.5, 1.7, 2, 2.5, 3, 3.5, 4, 5, 6, 8, 10, 20, ∞ (16 points)
	Out gain	0 dB to +18 dB (0.1 dB step)
	Knee	Hard, 1, 2, 3, 4, 5 (6 step)
	Attack	0 ms–120 ms (1 ms step)
	Release	5 ms–42.3 s (160 points) @ 48 kHz 6 ms–46.0 s (160 points) @ 44.1 kHz 3 ms–21.1 s (160 points) @ 96 kHz 3 ms–23.0 s (160 points) @ 88.2 kHz
Expander	Threshold	-54 dB to 0 dB (0.1 dB step)
	Ratio (x :1)	x=1, 1.1, 1.3, 1.5, 1.7, 2, 2.5, 3, 3.5, 4, 5, 6, 8, 10, 20, ∞ (16 points)
	Out gain	0 dB to +18 dB (0.1 dB step)
	Knee	Hard, 1, 2, 3, 4, 5 (6 points)
	Attack	0 ms–120 ms (1 ms step)
	Release	5 ms–42.3 s (160 points) @ 48 kHz 6 ms–46.0 s (160 points) @ 44.1 kHz 3 ms–21.1 s (160 points) @ 96 kHz 3 ms–23.0 s (160 points) @ 88.2 kHz
Compander H	Threshold	-54 dB to 0 dB (0.1 dB step)
	Ratio (x :1)	x=1, 1.1, 1.3, 1.5, 1.7, 2, 2.5, 3, 3.5, 4, 5, 6, 8, 10, 20 (15 points)
	Out gain	-18 dB to 0 dB (0.1 dB step)
	Width	1 dB–90 dB (1 dB step)
	Attack	0 ms–120 ms (1 ms step)
	Release	5 ms–42.3 s (160 points) @ 48 kHz 6 ms–46.0 s (160 points) @ 44.1 kHz 3 ms–21.1 s (160 points) @ 96 kHz 3 ms–23.0 s (160 points) @ 88.2 kHz
Compander S	Threshold	-54 dB to 0 dB (0.1 dB step)
	Ratio (x :1)	x=1, 1.1, 1.3, 1.5, 1.7, 2, 2.5, 3, 3.5, 4, 5, 6, 8, 10, 20 (15 points)
	Out gain	-18 dB to 0 dB (0.1 dB step)
	Width	1 dB–90 dB (1 dB step)
	Attack	0 ms–120 ms (1 ms step)
	Release	5 ms–42.3 s (160 points) @ 48 kHz 6 ms–46.0 s (160 points) @ 44.1 kHz 3 ms–21.1 s (160 points) @ 96 kHz 3 ms–23.0 s (160 points) @ 88.2 kHz

Libraries

Effect library	Presets	56
	User memories	72
Compressor library	Presets	36
	User memories	92
Gate library	Presets	4
	User memories	124
EQ library	Presets	40
	User memories	160
Channel library	Presets	2
	User memories	127
Input patch library	Presets	1
	User memories	32
Output patch library	Presets	1
	User memories	32

Analog Input Spec

Input	PAD	GAIN	Actual Load Impedance	For Use With Nominal	Input level			Connector
					Sensitivity ¹	Nominal	Max. before clip	
INPUT A/B 1–12	0	–60 dB	3 k Ω	50–600 Ω Mics & 600 Ω Lines	–70 dB (0.245 mV)	–60 dB (0.775 mV)	–40 dB (7.75 mV)	A: XLR-3-31 type (Balanced) ² B: Phone jack (TRS) (Balanced) ³
		–16 dB			–26 dB (38.8 mV)	–16 dB (123 mV)	+4 dB (1.23 V)	
	20	–6 dB (388 mV)			+4 dB (1.23 V)	+24 dB (12.28 V)		
INPUT 13–16	—	–26 dB	10 k Ω	600 Ω Lines	–36 dB (12.3 mV)	–26 dB (38.8 mV)	–6 dB (388 mV)	Phone jack (TRS) (Balanced) ³
		+4 dB			–6 dB (388 mV)	+4 dB (1.23 V)	+24 dB (12.28 V)	
CH INSERT IN 1–12	—	—	10 k Ω	600 Ω Lines	–12 dB (195 mV)	–2 dB (616 mV)	+18 dB (6.16 V)	Phone jack (TRS) (Unbalanced) ⁴
2TR IN [L, R]	—	—	10 k Ω	600 Ω Lines	–10 dBV (316 mV)	–10 dBV (316 mV)	+10 dBV (3.16 V)	RCA pin jack (Unbalanced)

1. Sensitivity is the lowest level that will produce an output of +4 dB (1.23 V) or the nominal output level when the unit is set to maximum gain. (All faders and level controls are maximum position.)
2. XLR-3-31 type connectors are balanced (1=GND, 2=HOT, 3=COLD).
3. Phone jacks are balanced (Tip=HOT, Ring=COLD, Sleeve=GND).
4. CH INSERT IN/OUT phone jacks are unbalanced. (Tip=OUTPUT, Ring=INPUT, Sleeve=GND).

In these specifications, when dB represents a specific voltage, 0 dB is referenced to 0.775 Vrms.

For 2TR IN levels, 0 dBV is referenced to 1.00 Vrms.

All input AD converters (CH INPUT 1–16) are 24-bit linear, 128-times oversampling. (@fs=44.1, 48 kHz)

+48 V DC (phantom power) is supplied to CH INPUT (1–12) XLR type connectors.

Three PHANTOM +48V switches CH1–4, 5–8, 9–12 turn on the phantom power for inputs 1–4, 5–8, 9–12 respectively.

Analog Output Specs

Output	Actual Source Impedance	For Use With Nominal	Output level		Connector
			Nominal	Max. before clip	
STEREO OUT [L, R]	75 Ω	600 Ω Lines	+4 dB (1.23 V)	+24 dB (12.28 V)	XLR-3-32 type (Balanced) ¹
OMNI OUT 1–4	150 Ω	10 k Ω Lines	+4 dB (1.23 V)	+24 dB (12.28 V)	Phone jack (TRS) (Balanced) ²
MONITOR OUT [L, R]	150 Ω	10 k Ω Lines	+4 dB (1.23 V)	+24 dB (12.28 V)	Phone jack (TRS) (Balanced) ²
CH INSERT OUT 1–12	600 Ω	10 k Ω Lines	–2 dB (616 mV)	+18 dB (6.16 V)	Phone jack (TRS) (Unbalanced) ³
2TR OUT [L, R]	600 Ω	10 k Ω Lines	–10 dBV (316 mV)	+10 dBV (3.16 V)	RCA Pin Jack (Unbalanced)
PHONES	100 Ω	8 Ω Phones	4 mW	25 mW	Stereo Phone Jack (TRS) (Unbalanced) ⁴
		40 Ω Phones	12 mW	75 mW	

1. XLR-3-32 type connectors are balanced (1=GND, 2=HOT, 3=COLD).
2. Phone jacks are balanced (Tip=HOT, Ring=COLD, Sleeve=GND).
3. CH INSERT IN/OUT phone jacks are unbalanced. (Tip=OUTPUT, Ring=INPUT, Sleeve=GND).
4. PHONES stereo phone jack is unbalanced (Tip=LEFT, Ring=RIGHT, Sleeve=GND).

In these specifications, when dB represents a specific voltage, 0 dB is referenced to 0.775 Vrms.

2TR OUT [L, R] levels, 0 dBV is referenced to 1.00 Vrms.

All output DA converters are 24-bit, 128-times oversampling. (@fs=44.1, 48 kHz)

Digital Input Spec

Input	Format	Data length	Level	Connector
2TR IN DIGITAL	IEC 60958	24-bit	0.5 V _{pp} /75 Ω	RCA pin jack
ADAT IN	ADAT ¹	24-bit	—	OPTICAL

1. ALESIS proprietary multichannel optical digital interface format

Digital Output Spec

Output	Format	Data length	Level	Connector
2TR OUT DIGITAL	IEC 60958 ¹ Consumer use	24-bit ³	0.5V pp/75 Ω	RCA pin jack
ADAT OUT	ADAT ²	24-bit ³	—	OPTICAL

1. Channel status of 2TR OUT DIGITAL
 Type: linear PCM
 Category code: Digital signal mixer
 Copy prohibit: NO
 Emphasis: NO
 Clock accuracy: Level II (1000 ppm)
 Sampling rate: depends on the internal configuration
2. ALESIS proprietary multichannel optical digital interface format
3. Dither: word length 16/20/24 bit

I/O SLOT Spec

The I/O SLOT accepts a mini YGDAI card. The SLOT has a serial interface.

Maker	Model	Function	Input	Output ¹	Format	Resolution	Frequency	The number of Available cards	Note	
Yamaha	MY8-AT	Digital I/O	8	8	ADAT	24 bit	44.1/48 kHz	1		
	MY16-AT		16	16						
	MY8-TD		8	8	TASCAM					
	MY16-TD		16	16						
	MY8-AE		8	8	AES/EBU					
	MY8-AEB		8	8						
	MY16-AE								16	16
	MY8-AE96S								8	8
	MY8-AE96				—					HD-SDI
	MY8-SDI-D		8	SD/HD-SDI						
	MY8-SDI-ED									
	MY4-AD	Analog In	4	—	Analog In	20 bit	44.1/48 kHz			
	MY8-AD24		8	—						
	MY8-AD96		8	—			44.1/48/88.2/96 kHz			
	MY4-DA	Analog Out	—	4	Analog Out	20 bit	44.1/48 kHz			
	MY8-DA96		—	8						
	MY8-ADDA96	Analog I/O	8	8	Analog In/Out	24 bit	44.1/48/88.2/96 kHz	1		
	MY16-CII	Network I/O	16	16	CobraNet					
MY16-ES64	EtherSound									
MY16-MD64	MADI									
MY16-mLAN	IEEE 1394									
MY16-EX	—	—	—	—	44.1/48/88.2/96 kHz					
Waves	Y96K	Effect Plug-In	8	8	Effect Plug-In	24 bit	44.1/48/88.2/96 kHz			
	WSG-Y16	SoundGrid	16	16	SoundGrid					
Audinate	Dante-MY16-AUD	Dante	16	16	Dante		48/96 kHz			
AVIOM	16/o-Y1	Network Out	—	16	A-Net Pro16	24 bit	44.1/48 kHz			
	6416Y2	Network I/O	16		A-Net Pro64		44.1/48/88.2/96 kHz			
AuviTran	AVY16-ES	Network I/O	16	16	EtherSound	24 bit	44.1/48/88.2/96 kHz	1		
	AVY16-ES100									
AudioService	MY16MADI64				MADI					
Media Numerics	RN.341.MY				RockNet				48/96 kHz	
Optocore	YG2				Optocore				44.1/48/88.2/96 kHz	
	YS2									

1. Selectable from STEREO/BUS/AUX/DIRECT/OUT/INSERT OUT/CASCADE OUT (STEREO, BUS1–8, AUX1–8, SOLO). Details depend on each interface card.

Refer to the Yamaha Pro Audio website for the latest information on mini-YGDAI cards.
<http://www.yamahaproaudio.com/>

MIDI/USB/WORD CLOCK I/O Spec

I/O Port		Format	Level	Connector in Console
TO HOST USB		USB 2.0	—	B type USB connector Audio: 16 in/16 out MIDI: 5 ports
MIDI	IN ¹	MIDI	—	DIN Connector 5P
	OUT	MIDI	—	DIN Connector 5P
	THRU	MIDI	—	DIN Connector 5P
WORD CLOCK	IN	—	TTL/75 Ω	BNC Connector
	OUT	—	TTL/75 Ω	BNC Connector

1. MIDI IN can use as TIME CODE IN MTC.

Dimensions

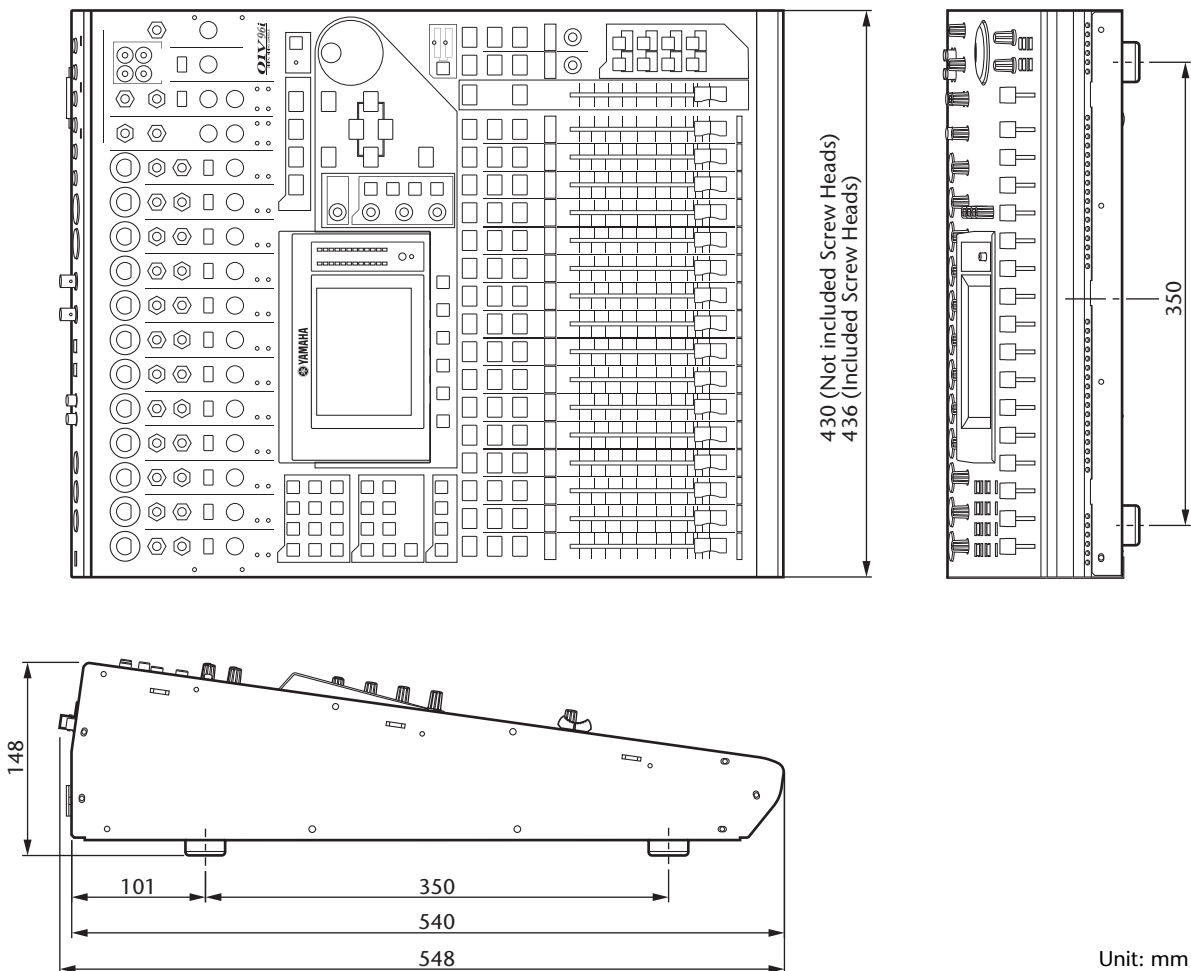

Specifications and descriptions in this owner's manual are for information purposes only. Yamaha Corp. reserves the right to change or modify products or specifications at any time without prior notice. Since specifications, equipment or options may not be the same in every locale, please check with your Yamaha dealer.

European Models
 Inrush Current based on EN 55103-1:2009
 5A (on initial switch-on)
 5A (after a supply interruption of 5s)
 Conforms to Environments: E1, E2, E3 and E4

Options

Rack Mounting the 01V96i Using RK1 Rack Mount Kit

You can rack mount the 01V96i using an optional RK1 Rack Mount Kit.

- 1.** Hold one of the brackets against one side of the 01V96i so that the bracket ear projects to the side, and align three holes on the bracket with the holes on the side of the 01V96i, as shown in the illustration below.
- 2.** Affix the bracket using three screws included in the RK1 package.
- 3.** Attach the other bracket to the other side of the 01V96i in the same way.

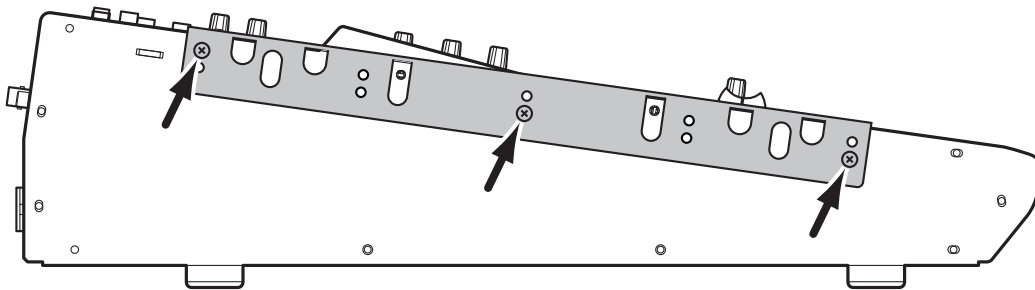

Index

Symbols

∅ /INSERT/DELAY button 12

Numerics

01V96i Editor7
 1–16/17–32 buttons 13
 1–8 46
 1–8 buttons 14
 1–8 buttons (Routing) 34
 2TR IN DIGITAL COAXIAL 17
 2TR IN/OUT connectors 11
 2TR OUT DIGITAL COAXIAL 17

A

AD Output Section 16
 AD15/16 selector 10
 ADAT IN/OUT connectors 17
 ASSIGN section 45
 ATT. 36
 Attaching a cover9
 AUX 1–AUX 8 buttons 12
 Aux Send 12

B

BANK 44, 46
 Buttons 20

C

CH1–32 page 23
 CH1–4 ON/OFF switch 16
 CH5–8 ON/OFF switch 16
 CH9–12 ON/OFF switch 16
 Channel faders 11
 Channel Strip Section 11
 Channels 22
 CLEAR button 15
 COMP (Compressor) 37
 Comp Edit page 37
 COMP GR 24
 Comp Lib page 37
 COMP. (H) (Compander Hard) 37
 COMP. (S) (Compander Soft) 37
 Compressing 37
 Confirmation Messages 21
 Connections and Setup 25
 Consumer format (IEC 60958) 17
 Contrast control 13
 Cursor buttons 15

D

D button (Routing) 34
 Daisy Chain Distribution 27
 Data Entry Section 15
 DEC/INC buttons 15
 DEL button 21
 Digital I/O Section 17
 DIO/SETUP button 12
 Direct Outs 33

Display 13, 19
 DISPLAY ACCESS Section 12
 Display Interface 20
 Display Pages 20
 Driver 7
 DYNAMICS button 12

E

EDIT indicator 19
 EFFECT button 13
 Effect page 24
 Effects 38
 Effects library 38
 ENTER button 15
 Enter titles 21
 EQ 35
 EQ button 13
 EQ Library 36
 EXPAND (Expander) 37

F

F (Frequency) 36
 F1–F4 buttons 13
 Factory default password 47
 Factory-preset 48
 FADER MODE Section 12
 Fader Modes 22
 Faders 20
 Firmware updates 8
 FREQUENCY control 14

G

G (Gain) 36
 GAIN control 10, 14
 GATE GR 24

H

H. SHELF (high-shelving) 36
 HIGH button 14
 HIGH-MID button 14
 HOME button 12
 HPF (high-pass filter) 36

I

In Name page 43
 INITIALIZE button 43, 46
 Initializing 48
 INPUT connectors 13–16 10
 INPUT connectors A/B 10
 Input Patching 31
 INPUT section 23
 INS button 21
 INSERT I/O connectors 10

L

L. SHELF (low-shelving) 36
 LAYER Section 13
 Layers 21
 LEVEL 24
 Level controls 12
 LEVEL section 45
 Lock page 47

Long name 43
 LOW button 14
 LOW-MID button 14

M

MASTER button 13
 Master page 23
 Metering 23
 MIDI button 12
 MIDI IN/THRU/OUT ports 17
 MIDI indicator 19
 MIDI/USB Section 17
 mini-YGDAI (Yamaha General Digital Audio Interface) I/O cards 18
 Mixing system 25
 MONITOR LEVEL control 11
 Monitor Levels 41
 Monitor Out & Headphones Section 11
 MONITOR OUT connectors L/R 16
 Monitor Source selector 11

N

Name Input Auto Copy check box 43

O

OMNI OUT connectors 1–4 16
 ON buttons 11, 12
 Operating Basics 19
 OPERATION LOCK 47
 Operation Lock 47
 OPERATION LOCK SAFE section 47
 Optional Card 18
 Oscillator 45
 Oscillator page 45
 Output Patching 31
 OUTPUT section 23

P

PAD switches 10
 PAIR/GROUP button 12
 Pairing 33
 PAN control 14
 PAN/ROUTING button 12
 Parameter Boxes 20
 Parameter wheel 15
 PASSWORD 48
 Password window 47
 PATCH button 12
 Patching
 Input Channels 29
 Output Channels 29
 PEAK HOLD button 24
 Peak Hold function 24
 PEAK indicators 10
 PHANTOM +48V 16
 PHONES jack 11
 PHONES LEVEL control 11
 Position page 23
 POST FADER 23
 POWER ON/OFF switch 18
 PRE EQ 23
 PRE FADER 23

Q

Q (slope)	35
Q control	14

R

RECALL button	14
Recording system	26
Recording to DAW Software	39
REMOTE button	13
Rotary controls	20
Routing	33

S

S button (Routing)	34
Sampling rate indicator	19
SCENE button	12
Scene Memories	42
SCENE MEMORY Section	14
Scene Up ▲ / Down ▼ buttons	14
SEL buttons	11, 12
SELECTED CHANNEL Section	14
Selecting	
Channels	22
Display Pages	20
Fader Modes	22
Layers	21
Setting the Input Levels	32
SHIFT LOCK button	21
Short name	43
Shortcut	46
SIGNAL indicators	10
SLOT Section	18
SOLO buttons	11, 12
SOLO indicator	15
SOLO Section	15
SPC button	21
ST IN button	12
ST IN page	23
ST IN Section	12
Star Distribution	27
STEREO fader	11
Stereo meters	13
Stereo Out	17
STEREO OUT connectors L/R	17
Stereo page	24
STEREO Section	11
STORE button	14
Studio Manager	7
Surround mode indicator	19
Synchronization status	28
Synchronize	27

T

Tab Scroll	13
TITLE	46
Title Edit Window	21
TO HOST USB port	17

U

USB 2.0 port	17
USB OUT	30
User Assignable Layer	44
User Define Select window	46
User Defined Keys	46
USER DEFINED KEYS Section	14
UTILITY button	12
Utility software	7

V

VIEW button	13
-------------------	----

W

WAVEFORM	45
WORD CLOCK IN connector	17
WORD CLOCK OUT connector	17
Wordclock	27
Wordclock master	27
Wordclock slave	27
Wordclock Source	28

Y

Yamaha Steinberg USB Driver	7
-----------------------------------	---

01V96i Block Diagram

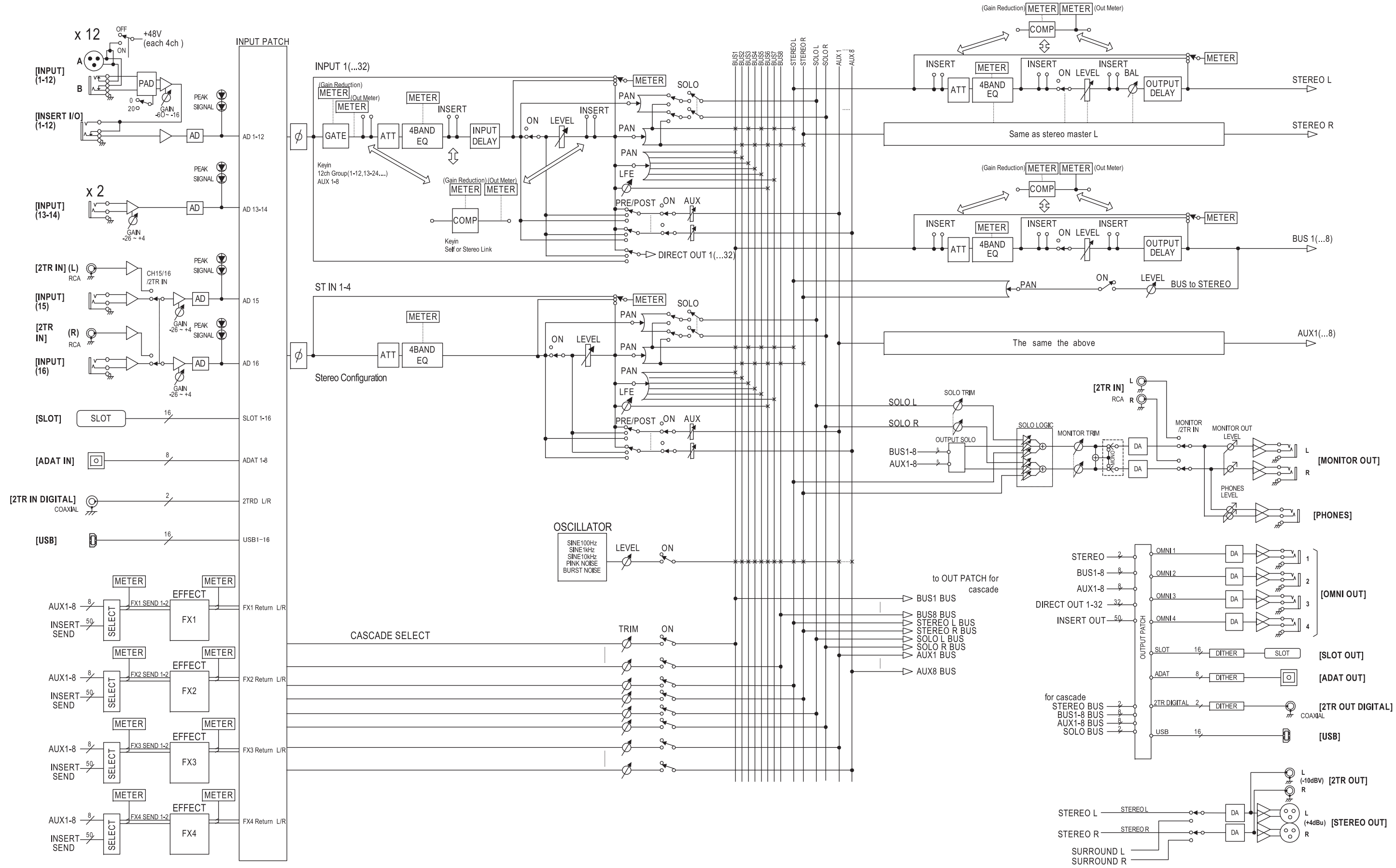

When 96kHz FX3,4 cannot be used.

01V96i Level Diagram

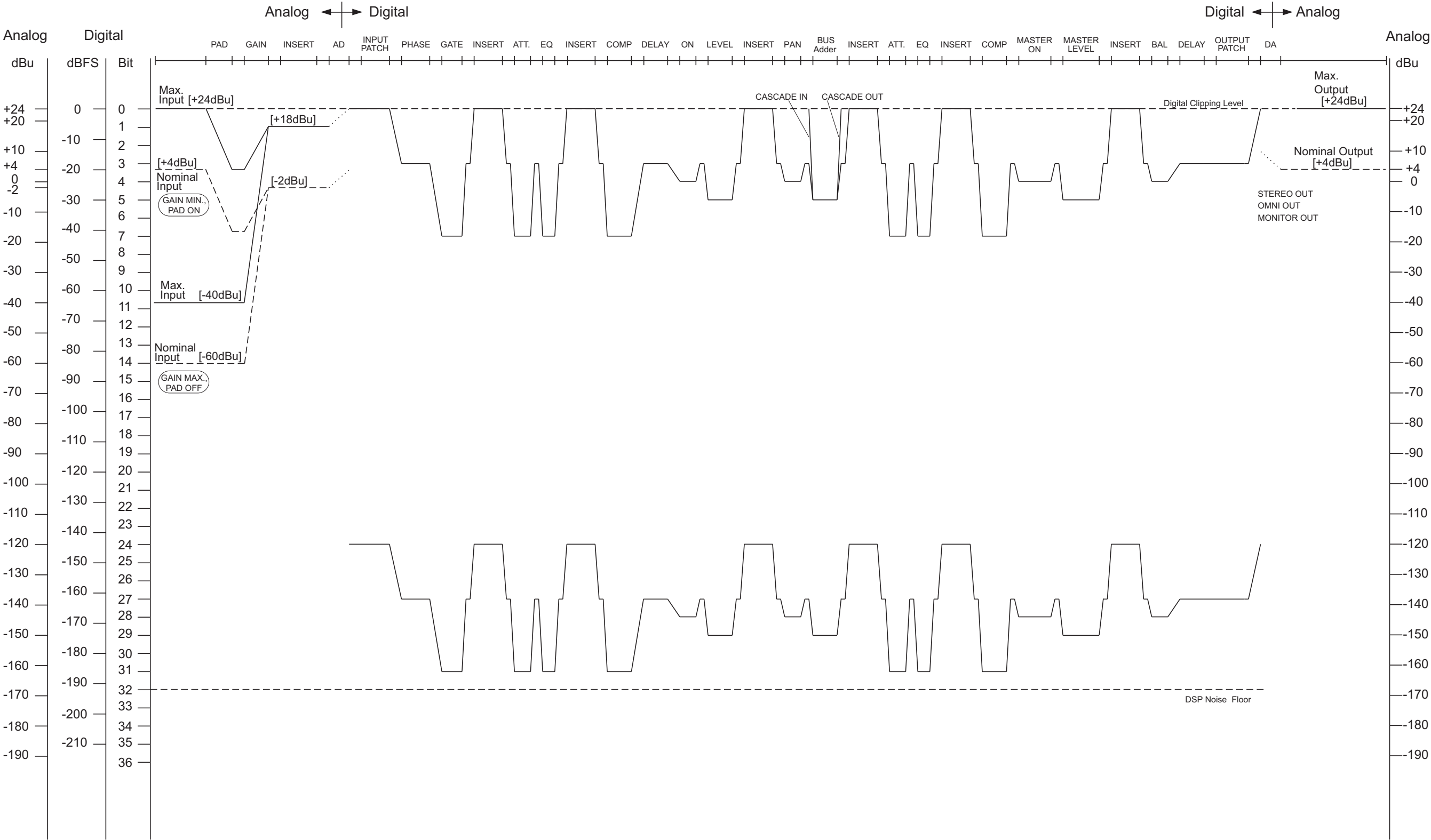

[0dBu = 0.775Vrms]
 [0dBFS = Full Scale]

For details of products, please contact your nearest Yamaha representative or the authorized distributor listed below.

Pour plus de détails sur les produits, veuillez-vous adresser à Yamaha ou au distributeur le plus proche de vous figurant dans la liste suivante.

Die Einzelheiten zu Produkten sind bei Ihrer unten aufgeführten Niederlassung und bei Yamaha Vertragshändlern in den jeweiligen Bestimmungsländern erhältlich.

Para detalles sobre productos, contacte su tienda Yamaha más cercana o el distribuidor autorizado que se lista debajo.

NORTH AMERICA

CANADA

Yamaha Canada Music Ltd.
135 Milner Avenue, Scarborough, Ontario,
M1S 3R1, Canada
Tel: 416-298-1311

U.S.A.

Yamaha Corporation of America
6600 Orangethorpe Ave., Buena Park, Calif. 90620,
U.S.A.
Tel: 714-522-9011

CENTRAL & SOUTH AMERICA

MEXICO

Yamaha de México S.A. de C.V.
Calz. Javier Rojo Gómez #1149,
Col. Guadalupe del Moral
C.P. 09300, México, D.F., México
Tel: 55-5804-0600

BRAZIL

Yamaha Musical do Brasil Ltda.
Rua Joaquim Floriano, 913 - 4º andar, Itaim Bibi,
CEP 04534-013 Sao Paulo, SP. BRAZIL
Tel: 011-3704-1377

ARGENTINA

**Yamaha Music Latin America, S.A.
Sucursal de Argentina**
Olga Cossetini 1553, Piso 4 Norte
Madero Este-C1107CEK
Buenos Aires, Argentina
Tel: 011-4119-7000

PANAMA AND OTHER LATIN AMERICAN COUNTRIES/ CARIBBEAN COUNTRIES

Yamaha Music Latin America, S.A.
Torre Banco General, Piso 7, Urbanización Marbella,
Calle 47 y Aquilino de la Guardia,
Ciudad de Panamá, Panamá
Tel: +507-269-5311

EUROPE

THE UNITED KINGDOM/IRELAND

Yamaha Music Europe GmbH (UK)
Sherbourne Drive, Tilbrook, Milton Keynes,
MK7 8BL, England
Tel: 01908-366700

GERMANY

Yamaha Music Europe GmbH
Siemensstraße 22-34, 25462 Rellingen, Germany
Tel: 04101-3030

SWITZERLAND/LIECHTENSTEIN

**Yamaha Music Europe GmbH
Branch Switzerland in Zürich**
Seefeldstrasse 94, 8008 Zürich, Switzerland
Tel: 044-387-8080

AUSTRIA/BULGARIA

Yamaha Music Europe GmbH Branch Austria
Schleiergasse 20, A-1100 Wien, Austria
Tel: 01-60203900

CZECH REPUBLIC/HUNGARY/ ROMANIA/SLOVAKIA/SLOVENIA

**Yamaha Music Europe GmbH
Branch Austria (Central Eastern Europe Office)**
Schleiergasse 20, A-1100 Wien, Austria
Tel: 01-602039025

POLAND/LITHUANIA/LATVIA/ESTONIA

**Yamaha Music Europe GmbH
Branch Sp.z o.o. Oddział w Polsce**
ul. 17 Stycznia 56, PL-02-146 Warszawa, Poland
Tel: 022-500-2925

MARTA

Olimpus Music Ltd.
The Emporium, Level 3, St. Louis Street Msida
MSD06
Tel: 02133-2144

THE NETHERLANDS/ BELGIUM/LUXEMBOURG

Yamaha Music Europe Branch Benelux
Clarissenhof 5-b, 4133 AB Vianen, The Netherlands
Tel: 0347-358 040

FRANCE

Yamaha Music Europe
BP 70-77312 Marne-la-Vallée Cedex 2, France
Tel: 01-64-61-4000

ITALY

Yamaha Music Europe GmbH, Branch Italy
Viale Italia 88, 20020 Lainate (Milano), Italy
Tel: 02-935-771

SPAIN/PORTUGAL

**Yamaha Music Europe GmbH Ibérica, Sucursal
en España**
Ctra. de la Coruna km. 17, 200, 28230
Las Rozas (Madrid), Spain
Tel: +34-902-39-8888

GREECE

Philippos Nakas S.A. The Music House
147 Skiathou Street, 112-55 Athens, Greece
Tel: 01-228 2160

SWEDEN/FINLAND/ICELAND

**Yamaha Music Europe GmbH Germany filial
Scandinavia**
J. A. Wettergrens Gata 1, Box 30053
S-400 43 Göteborg, Sweden
Tel: 031 89 34 00

DENMARK

**Yamaha Music Europe GmbH, Tyskland – filial
Denmark**
Generatorvej 6A, DK-2730 Herlev, Denmark
Tel: 44 92 49 00

NORWAY

**Yamaha Music Europe GmbH Germany -
Norwegian Branch**
Grini Næringspark 1, N-1345 Østerås, Norway
Tel: 67 16 77 70

RUSSIA

Yamaha Music (Russia)
Room 37, bld. 7, Kievskaya street, Moscow,
121059, Russia
Tel: 495 626 5005

OTHER EUROPEAN COUNTRIES

Yamaha Music Europe GmbH
Siemensstraße 22-34, 25462 Rellingen, Germany
Tel: +49-4101-3030

AFRICA

**Yamaha Corporation,
Asia-Pacific Sales & Marketing Group**
Nakazawa-cho 10-1, Naka-ku, Hamamatsu,
Japan 430-8650
Tel: +81-53-460-2303

MIDDLE EAST

TURKEY/CYPRUS

Yamaha Music Europe GmbH
Siemensstraße 22-34, 25462 Rellingen, Germany
Tel: 04101-3030

OTHER COUNTRIES

Yamaha Music Gulf FZE
LOB 16-513, P.O.Box 17328, Jubel Ali,
Dubai, United Arab Emirates
Tel: +971-4-881-5868

ASIA

THE PEOPLE'S REPUBLIC OF CHINA

Yamaha Music & Electronics (China) Co.,Ltd.
2F, Yunhedasha, 1818 Xinzha-lu, Jingan-qu,
Shanghai, China
Tel: 021-6247-2211

INDIA

Yamaha Music India Pvt. Ltd.
5F Ambience Corporate Tower Ambience Mall Complex
Ambience Island, NH-8, Gurgaon-122001, Haryana, India
Tel: 0124-466-5551

INDONESIA

**PT. Yamaha Musik Indonesia (Distributor)
PT. Nusantik**
Gedung Yamaha Music Center, Jalan Jend. Gatot
Subroto Kav. 4, Jakarta 12930, Indonesia
Tel: 021-520-2577

KOREA

Yamaha Music Korea Ltd.
8F, 9F, Dongsung Bldg. 158-9 Samsung-Dong,
Kangnam-Gu, Seoul, Korea
Tel: 02-3467-3300

MALAYSIA

Yamaha Music (Malaysia) Sdn., Bhd.
Lot 8, Jalan Perbandaran, 47301 Kelana Jaya,
Petaling Jaya, Selangor, Malaysia
Tel: 03-78030900

SINGAPORE

Yamaha Music (Asia) Pte., Ltd.
#03-11 A-Z Building
140 Paya Lebor Road, Singapore 409015
Tel: 6747-4374

TAIWAN

Yamaha KHS Music Co., Ltd.
3F, #6, Sec.2, Nan Jing E. Rd. Taipei.
Taiwan 104, R.O.C.
Tel: 02-2511-8688

THAILAND

Siam Music Yamaha Co., Ltd.
4, 6, 15 and 16th floor, Siam Motors Building,
891/1 Rama 1 Road, Wangmai,
Pathumwan, Bangkok 10330, Thailand
Tel: 02-215-2622

OTHER ASIAN COUNTRIES

**Yamaha Corporation,
Asia-Pacific Sales & Marketing Group**
Nakazawa-cho 10-1, Naka-ku, Hamamatsu,
Japan 430-8650
Tel: +81-53-460-2303

OCEANIA

AUSTRALIA

Yamaha Music Australia Pty. Ltd.
Level 1, 99 Queensbridge Street, Southbank,
Victoria 3006, Australia
Tel: 3-9693-5111

COUNTRIES AND TRUST TERRITORIES IN PACIFIC OCEAN

**Yamaha Corporation,
Asia-Pacific Sales & Marketing Group**
Nakazawa-cho 10-1, Naka-ku, Hamamatsu,
Japan 430-8650
Tel: +81-53-460-2303



Yamaha Pro Audio Global Web Site
<http://www.yamahaproaudio.com/>
Yamaha Manual Library
<http://www.yamaha.co.jp/manual/>

C.S.G., Pro Audio Division
© 2011 Yamaha Corporation

110IPTO-A0
Printed in Japan

WZ74200