

HDbridge 2840

CONFIGURATION GUIDE



HDbridge2000
SERIES

INSTRUCTIONS PERTAINING TO A RISK OF FIRE, ELECTRIC SHOCK, OR INJURY TO PERSONS

Important Safety Instructions. Save These Instructions.

WARNING: When using electronic products, basic precautions should always be followed, including:

1. Keep these instructions.
2. Heed all warnings.
3. Follow all instructions.
4. Do not use this apparatus near water.
5. Clean only with dry cloth.
6. Do not block any ventilation openings. Install in accordance with the manufacturer's instructions.
7. Do not install near any heat sources such as radiators, heat registers, stoves, or other apparatus (including amplifiers) that produce heat.
8. Do not defeat the safety purpose of the polarized or grounding-type plug. A polarized plug has two blades with one wider than the other. A grounding type plug has two blades and a third grounding prong. The wide blade or the third prong is provided for your safety. If the provided plug does not fit into your outlet, consult an electrician for replacement of the obsolete outlet.
9. Power cord must be accessible to allow for the removal of power from the unit.
10. Protect the power cord from being walked on or pinched, particularly at plugs, convenience receptacles, and the point where they exit from the apparatus.
11. Unplug the apparatus during lightning storms or when unused for long periods of time.
12. Only use attachments/accessories specified by the manufacturer.
13. Refer all servicing to qualified service personnel. Servicing is required when the apparatus has been damaged in any way, such as power-supply cord or plug is damaged, liquid has been spilled or objects have fallen into the apparatus, the apparatus has been exposed to rain or moisture, does not operate normally, or has been dropped.
14. WARNING: To reduce the risk of fire or electric shock do not place this apparatus in a position where it is exposed to dripping or splashing liquids, rain, moisture, or excessively high humidity. Objects containing liquid shall not be placed in proximity to the unit such that they present a risk of spillage onto the apparatus.



The lightning flash with arrowhead symbol, within an equilateral triangle, is intended to alert the user to the presence of uninsulated "dangerous voltage" within the product's enclosure that may be of sufficient magnitude to constitute a risk to persons.



The exclamation point within an equilateral triangle is intended to alert the user to the presence of important operating and maintenance (servicing) instructions in the literature accompanying the product.

FCC Statement

FCC Compliance and Advisory Statement: This hardware device complies with Part 15 of the FCC rules. Operation is subject to the following two conditions: 1) this device may not cause harmful interference, and 2) this device must accept any interference received including interference that may cause undesired operation. This equipment has been tested and found to comply with the limits for a Class A digital device, pursuant to Part 15 of the FCC Rules. These limits are designed to provide reasonable protection against harmful interference in a commercial installation. This equipment generates, uses, and can radiate radio frequency energy and, if not installed or used in accordance with the instructions, may cause harmful interference to radio communications. However there is no guarantee that interference will not occur in a particular installation. If this equipment does cause harmful interference to radio or television reception, which can be determined by turning the equipment off and on, the user is encouraged to try to correct the interference by one or more of the following measures: 1) reorient or relocate the receiving antenna; 2) increase the separation between the equipment and the receiver; 3) connect the equipment to an outlet on a circuit different from that to which the receiver is connected; 4) consult the dealer or an experienced radio/TV technician for help. Any changes or modifications not expressly approved by the party responsible for compliance could void the user's authority to operate the equipment. Where shielded interface cables have been provided with the product or specified additional components or accessories elsewhere defined to be used with the installation of the product, they must be used in order to ensure compliance with FCC regulations.

Welcome to ZeeVee.

ZeeVee products convert your video and audio source to a digital cable channel and broadcast it over coax to all your HDTVs. This guide walks you through basic and more enhanced setup for ZeeVee's HDbridge 2840 modulator.

If you run into problems during setup, feel free to contact Technical Support at +1(877) 4-ZEEVEE (1.877.493.3833).

What's in the Box

Here's what you can expect to find when you open the package:



ZeeVee Modulator



AC Power Cord

Available Separately



HDMI Cables

Table of Contents

Front and Back Panels	4
Basic Installation	5
Beginning setup	5
Tuning your channel at the HDTV (Auto Scan)	5
Front Panel Configuration	6-7
Setting the RF broadcast channels or power	6
Cable TV Channels vs RF Frequency (MHz) Map	7
Maestro Configuration	8-9
Connecting with Maestro	8
Configuring RF numbers and virtual channels	8
Labeling channels with channel and content information	8
Using other Maestro tabs	9
Troubleshooting	10
Warranty	11
Contact ZeeVee	12



Front and Back Panels

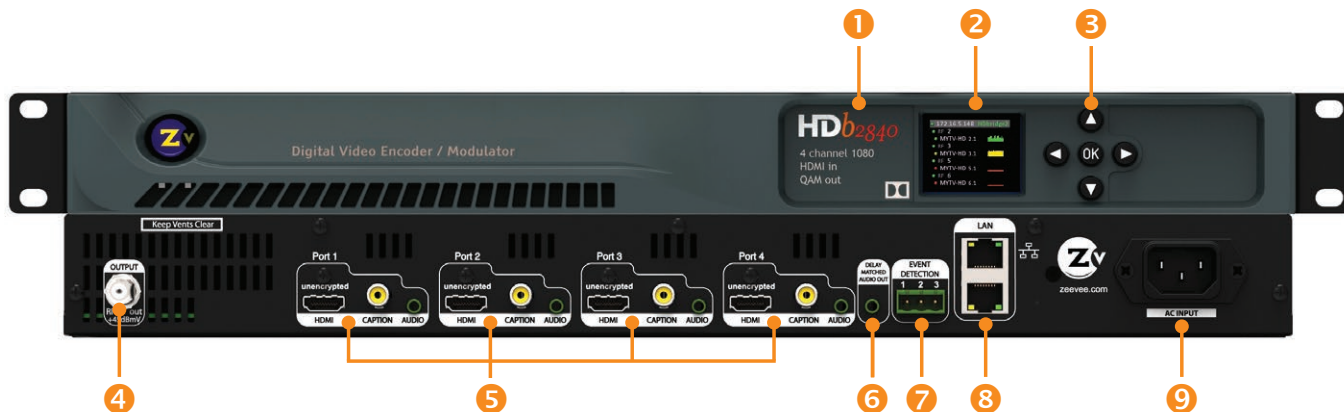

1	HDb2840	Name and description of unit
2	Color Display	Configuration and system status
3	5-Way Control	Navigate options on front panel display
4	Coax Output	Up to 2 paired, frequency-agile QAM RF CATV output channels for up to 4 video sources. Output power can be set between +45 to +25 dBmV using the Maestro web interface or the front panel.
5	Audio/Video Inputs	Digital Audio/Video: Unencrypted HDMI Closed Caption: Composite Analog Audio: 3.5mm Audio
6	Delay Matched Audio Out	For matching audio to external audio system (first port only, requires analog audio as input)
7	Event Detection	This function not implemented yet
8	10/100 LAN Port	Two symmetrical Ethernet ports for configuration and remote management
9	A/C Power Input	100-240VAC / 50-60Hz

Basic Installation

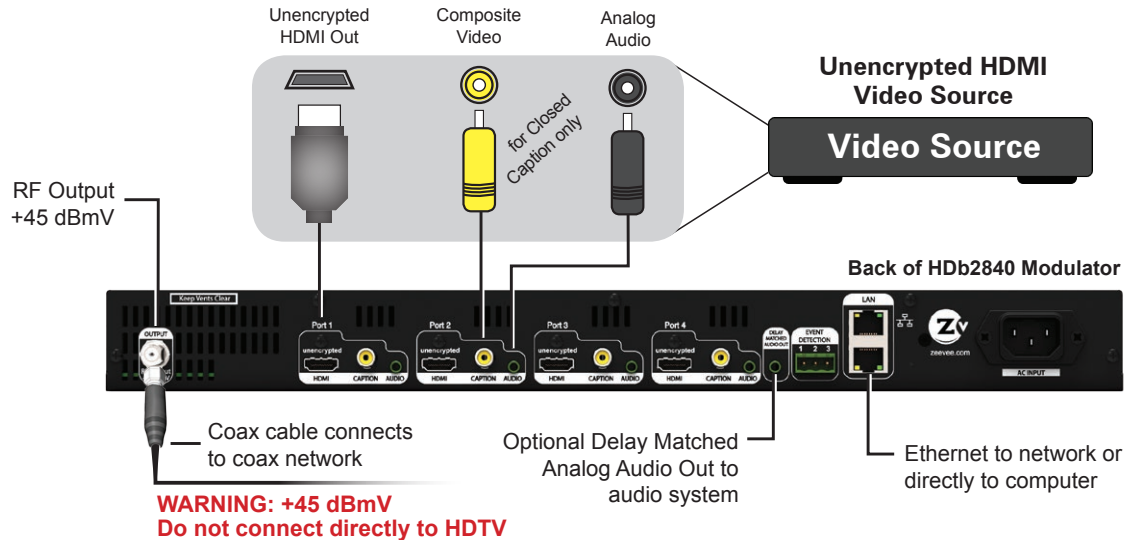

Factory default settings allow HDb2840 units to broadcast up to 4 unencrypted HDMI sources on RF channels 2, 3, 5, and 6 for reception at connected HDTVs.

We recommend using the most updated version of firmware. You can find the latest version on the Support section of our website.

Beginning setup

1. Apply power.
2. Connect an HDMI video source to the HDMI input port of the HDb2840, using an HDMI cable (which is sold separately). For Closed Captioning, connect a composite (yellow) cable from the video source to the Caption port.
3. *Optional* – Connect the Analog Audio if the digital audio is not present on HDMI or if you want to implement the delay matched audio feature.

Tuning your channel at the HDTV (Auto Scan)

1. Connect the Coaxial Output of the HDb2840 to your RF network.
If the RF power for your network is too high, you will observe video breakup.
2. Specify Cable (not Air or Antenna) setting in your TV menu.
3. Enter the RF number to tune directly to the channel. For default channel lineup information, refer to the Default Channel Lineup table.
If you cannot tune directly to the channel at this point, it is because most TVs will require you to run a full Auto Scan.
4. Run the Auto Scan through the menu system of your HDTV to find the channels.

DEFAULT CHANNEL LINEUP

AV Input	RF #	HDTV Channel
AV Input 1	2	2.1
AV Input 2	3	3.1
AV Input 3	5	5.1
AV Input 4	6	6.1

Front Panel Configuration



Shows audio/video being encoded

Green — Both audio and video are detected

Yellow — Video, but no audio detected

Red — No video detected

You can set the RF broadcast channels using the front panel controls. In many cases, your ZeeVee modulator will require only these configurations.

Setting the RF broadcast channels or power

1. Unlock the panel by pressing/holding together the left and right arrow buttons (◀▶) until "Setup" lights up.
2. Press "OK" to enter the Configuration screen.
3. Use the arrow buttons (▲▼◀▶) to go to each item you want to configure (such as RF Number or RF Power), then press "OK" to edit the highlighted field. Use the up and down (▲▼) arrow buttons to scroll through the options for that field.
4. Once you've made changes, press "OK" to accept. You can then select the next item for configuration.
5. When finished making changes, use the arrow buttons to scroll down and select "Apply," then click "OK" to save your changes.

Note: The front panel locks automatically after a few seconds. To make more changes, press/hold the left and right arrow buttons again to re-enter the setup screen.



SETUP SCREEN

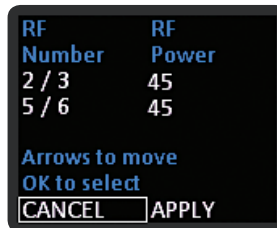

CONFIGURATION SCREEN

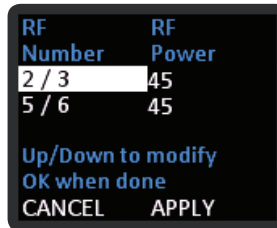

ACTIVE CONFIGURATION SCREEN

To update firmware:

- If unit is connected to the internet and can communicate with our servers, select Update Firmware from the Setup screen and press "OK".

To reset IP address:

- When using DHCP, select Reset IP Address to force a release/renew of your IP address, and press "OK".

To restore factory defaults or revert firmware:

1. Power down the unit.
2. Hold the left and right arrows down and reapply power. You will be prompted to a screen:
 - Press up arrow to reset to defaults;
 - Press down arrow to revert firmware.

Map for configuring RF numbers and virtual channels

The Cable TV Channels vs RF Frequency (MHz) Map shows how the RF channels are paired and matched with RF frequency. You will need to refer to this map when configuring RF numbers and virtual channels.

IMPORTANT NOTES

- RF numbers are applied in pairs based on the frequency map. For instance, if you enter RF # "2," then RF # "3" automatically populates.
- RF numbers "4" and "5" cannot be paired together because of a gap in the frequencies (MHz).
- The RF numbers are not always paired in numerical sequence (as with RF # 6, which pairs with 95, and RF # 99 which pairs with 14 and so on).
- ZV channels can be set directly adjacent to any other well-formed channel and will not cause interference. No channel spacing is required.

Cable TV Channels vs RF Frequency (MHz) Map

RF Ch.	Band (MHz)	RF Ch.	Band (MHz)	RF Ch.	Band (MHz)	RF Ch.	Band (MHz)	RF Ch.	Band (MHz)
2	54-60	27	240-246	57	420-426	87	600-606	122	780-786
3	60-66	28	246-252	58	426-432	88	606-612	123	786-792
4	66-72	29	252-258	59	432-438	89	612-618	124	792-798
5	76-82	30	258-264	60	438-444	90	618-624	125	798-804
6	82-88	31	264-270	61	444-450	91	624-630	126	804-810
95	90-96	32	270-276	62	450-456	92	630-636	127	810-816
96	96-102	33	276-282	63	456-462	93	636-642	128	816-822
97	102-108	34	282-288	64	462-468	94	642-648	129	822-828
98	108-114	35	288-294	65	468-474	100	648-654	130	828-834
99	114-120	36	294-300	66	474-480	101	654-660	131	834-840
14	120-126	37	300-306	67	480-486	102	660-666	132	840-846
15	126-132	38	306-312	68	486-492	103	666-672	133	846-852
16	132-138	39	312-318	69	492-498	104	672-678	134	852-858
17	138-144	40	318-324	70	498-504	105	678-684	135	858-864
18	144-150	41	324-330	71	504-510	106	684-690	HRC Frequencies = Standard Frequencies minus 1.25 MHz Except for: Channel 5, Video = 78.0 MHz Channel 6, Video = 84.0 MHz IRC Frequencies = Same as Standard Frequencies Except for: Channel 5, Video = 79.25 MHz Channel 6, Video = 85.25 MHz	
19	150-156	42	330-336	72	510-516	107	690-696		
20	156-162	43	336-342	73	516-522	108	696-702		
21	162-168	44	342-348	74	522-528	109	702-708		
22	168-174	45	348-354	75	528-534	110	708-714		
7	174-180	46	354-360	76	534-540	111	714-720		
8	180-186	47	360-366	77	540-546	112	720-726		
9	186-192	48	366-372	78	546-552	113	726-732		
10	192-198	49	372-378	79	552-558	114	732-738		
11	198-204	50	378-384	80	558-564	115	738-744		
12	204-210	51	384-390	81	564-570	116	744-750		
13	210-216	52	390-396	82	570-576	117	750-756		
23	216-222	53	396-402	83	576-582	118	756-762		
24	222-228	54	402-408	84	582-588	119	762-768		
25	228-234	55	408-414	85	588-594	120	768-774		
26	234-240	56	414-420	86	594-600	121	774-780		

The highlighted areas in the frequency map show the RF numbers that can be paired together but are not numerically sequential.

Maestro Configuration

Maestro is a configuration tool that you use optionally to customize your system beyond what is allowed in the front panel. For example, using Maestro you can assign a channel number (virtual channel) independent of the RF number and label the channels.

Connecting with Maestro

1. Connect your computer directly to the ZeeVee modulator using a standard Ethernet cable (not a cross-over cable) or connect the unit and your computer to any LAN that has a DHCP server.

2. After a few moments, an IP address will appear at the top of the front panel display.

3. Using any web browser (Chrome or Firefox preferred), enter the IP address to launch Maestro.

4. You will be directed to a login page. Your user name is always “admin.” The default password is “admin” but you can change the password. Login is case-sensitive.

5. After you log in, the Maestro Status tab appears. Here you can see the general information status.

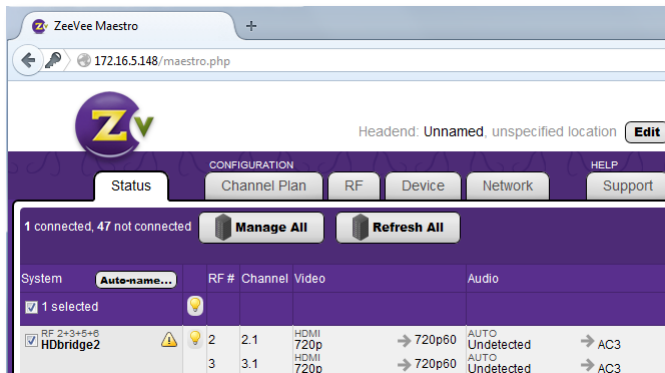

Configuring RF numbers and virtual channels

1. Click on the Channel Plan tab.

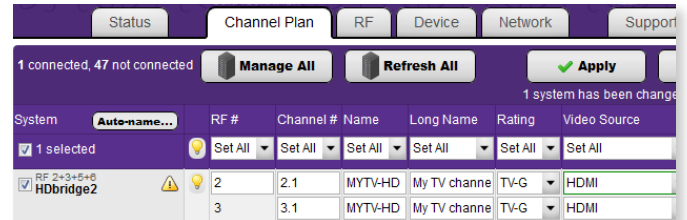

2. Click in the RF # field and enter the RF number as you choose from the RF Frequency Map (on page 7). Make sure you've reviewed the RF Frequency Map Important Notes before completing this task.

3. Click in the Channel # field and enter a channel number (virtual channel). The channel number is what the TV displays. You can configure a channel number two ways:

- As a dotted number — Enter the number with a "." following it, for example, "5.1". This is the default display.
- As a dotless number — Enter the number with a "#" preceding it, for example, "#5".

Note that you can choose a channel number that is different from the RF#. For instance, if your RF# is 3, you can choose a channel number of 10.1 or #10.

4. Click Apply to save changes. Your unit stores configurations so they are not lost on power-down.

5. Run Auto Scan at TV (see Tuning your channel at the HDTV, page 5) when you have saved configuration changes.

Labeling channels with channel and content information

1. In the Channel Plan tab, click in the Name field and enter the channel short name (up to 7 characters).

2. Click in the Long Name field and enter the long or more descriptive channel name (up to 63 characters). The TV displays these names and descriptions when the channel is changed or info guide information is requested.

3. Click Apply to save changes.

Using the Maestro tabs

Click on the Maestro tabs to configure your unit as needed. We provide brief information here. Please click on the Help button on each tab or refer to the Support section of our website for further detail on configuration options.

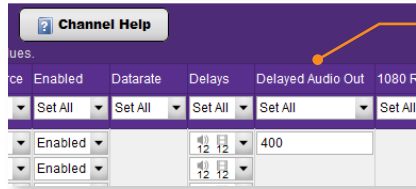

Delayed Audio Out found on the Channel Plan tab allows for matching audio to external audio system (first port only).

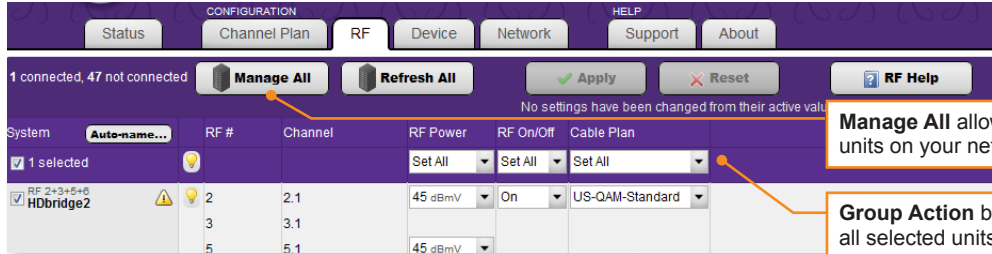

THE RF TAB

Allows you to change the RF power output.

Manage All allows you to view and configure all units on your network.

Group Action bar allows you to set configuration for all selected units actively managed on your network.

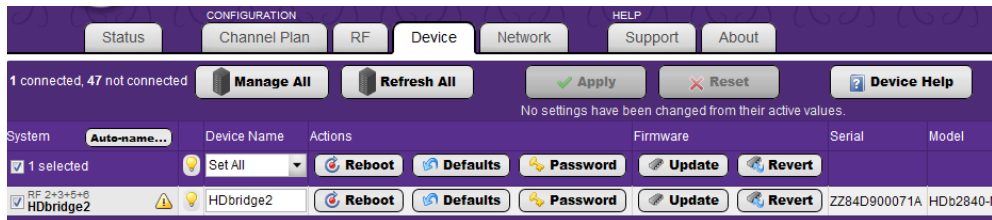

THE DEVICE TAB

Allows you to change the device password and update firmware as well as configure Emergency Alerts System (EAS). You can find detailed information on EAS in the Support section of the website.

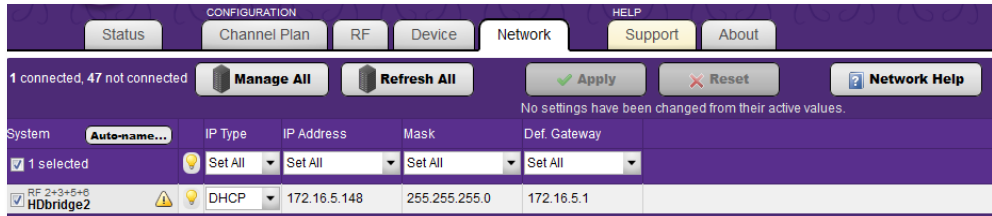

THE NETWORK TAB

Allows you to assign a static IP address.

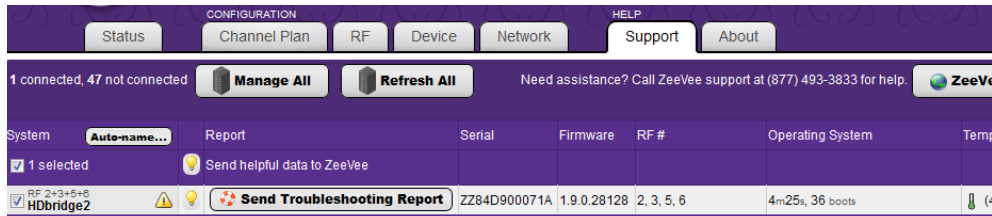

THE SUPPORT TAB

Provides technical support contact information and allows you to send logs for troubleshooting.

Troubleshooting

Unable to Connect to Maestro

If unable to connect, try one of the following:

► **If you are getting a page not found error when directly connected to a PC**, try disabling WIFI. If that does not correct it, make sure your PC is not using a static IP address. The PC and the HDbridge2000 unit must be on the same IP subnet for them to communicate. For details on how to check for a static IP address, please see the FAQ section of our website.

► **If the page loads, but all you see is a purple background and the ZeeVee logo (and are not prompted to log in)** please try a different web browser. We have found some older versions of Internet Explorer are not compatible with the Maestro tool. Updating IE or using Firefox or Chrome should correct the issue.

No picture or channel found at TV

Verify the HDTV has a QAM (digital cable) tuner. Verify that you have performed a full channel scan on the HDTV with "cable mode" selected. Lower the power on the unit, then verify that the modulator is not conflicting with any other channel by connecting the unit directly to the HDTV.

Idle Screen (bouncing logo)

One reason this may happen is when the unit does not detect video input. Verify the source is on and producing a video signal, then verify the source is outputting a supported resolution. If the HDMI video input is encrypted (HDCP), the idle screen will also display an error message that reads: "Encrypted video detected – unsupported." The ZeeVee unit will only support unencrypted video sources.

Image Breakup

Image or video break up is often caused by an issue in the RF/coax network. You may have chosen a channel number that is not completely vacant.

If you are combining with other modulators, be sure the RF# selected on the unit does not conflict with any other channels, keep in mind that some analog modulators may spill over to adjacent channels and cause unexpected interference.

If you are combining with a cable service, keep in mind that they sometimes have extra signals that a TV will not display and can cause interference.

There may also be an RF power balance issue. Verify that the RF power of the unit is balanced with signals from other modulators and from the cable company. As a test, try removing all other signals (cable, other modulators, etc) and see if you still see similar issues.

Some TVs will also show video issues if the signal strength is too high. Try lowering the RF power on the unit to ensure you are not overdriving the HDTV tuner.

VGA or HDMI video does not fill HDTV screen

The unit is broadcasting in "compatibility mode." This means it's receiving a resolution from your VGA/HDMI source that doesn't match standard 1280x720 or 1920x1080 HDTV picture resolutions. When that happens, the unit fits the incoming picture inside either a 720 or 1080 window and pads the outside area with black. To resolve the issue, set your VGA source to output 1280x720 or 1920x1080 resolution. For more detailed information about setting up VGA and HDMI resolutions, see the FAQ section of our website.

Audio and video are not synchronized

If both the audio and video are being sent through the unit to the TV, be sure your firmware is fully updated, later versions of firmware may have lip sync corrections.

If you are feeding the audio directly from the source into a distributed (whole house) audio system and not through the ZeeVee unit, it will arrive to the speakers before the video arrives to the HDTV. This happens because the video is being encoded into a digital signal, modulated by the unit and then demodulated at the HDTV. Each of these steps adds latency that will not be reflected in the audio because it is traveling a shorter path.

To work around the issue, you can try one of the following:

► Use an audio delay device that allows you to add a delay to the audio stream before it reaches the sound system.

► Feed the audio to the ZeeVee unit and send it to the HDTV with the video. Then take the audio out from an HDTV or external QAM tuner (such as the ZvSync) and connect it to your audio system. The audio should have a similar amount of delay since it has gone through the encoding and decoding process just as the video did.

WARRANTY

HDbridge 2000 Series
and ZvPro Product Lines
ZeeVee, Inc. January 1, 2014



LIMITED FIVE YEAR WARRANTY

ZeeVee warrants your ZeeVee Equipment (defined to include only HDbridge Series and ZvPro Series of equipment) against defects in materials and workmanship for a period of five years from the date of purchase. ZeeVee's limited warranty extends only to the original end user purchaser or any person receiving the ZeeVee Equipment as a gift from the original end user purchaser and to no other purchaser or transferee. All warranties implied by law, including any implied warranties of merchantability and fitness for a particular purpose, are expressly limited to the duration of this express limited warranty. Some countries or states of the U.S. do not allow limitations on how long an implied warranty lasts, so the above limitation may not apply to you.

EXCLUSIVE REMEDY FOR ZEEVEE EQUIPMENT

At the option of ZeeVee, the ZeeVee Equipment will be repaired or replaced with a new, repaired or refurbished product (whichever ZeeVee deems as necessary) if it becomes defective or inoperative. If ZeeVee cannot reasonably repair or replace the ZeeVee Equipment then ZeeVee may, at its sole discretion, refund the original purchase price or the current retail price of the ZeeVee Equipment. If ZeeVee chooses to repair or replace the ZeeVee Equipment, or to refund the purchase price, this will be the exclusive remedy. With the exception of any warranties implied by the law of any country or state of the U.S., this express limited warranty is exclusive and in lieu of all other warranties, guarantees, agreements and similar obligations of ZeeVee.

THE ABOVE WARRANTIES ARE SUBJECT TO THE FOLLOWING CONDITIONS

- You must have proof of purchase from an authorized ZeeVee dealer to receive warranty service. A sales receipt or other document showing that you purchased the ZeeVee Equipment is considered proof of purchase.
- Warranty coverage begins the day the original end user purchaser or any person receiving the ZeeVee Equipment as a gift from the original end user

purchaser purchased the ZeeVee Equipment.

- All ZeeVee Equipment, including replacement products, are covered only for the original warranty period. When the warranty on the original product expires, the warranty on the replacement product also expires.
- If we determine that the problem is not covered under the limited warranty, we will notify you and inform you of service or replacement alternatives that are available to you on a fee basis.
- In the case of a paid repair: at the option of ZeeVee, the ZeeVee Equipment will be repaired or replaced with a new, repaired, refurbished, or comparable product (whichever ZeeVee deems as necessary).
- ZeeVee Equipment must be purchased through an authorized ZeeVee distribution partner and dealer/reseller. Check zeevee.com for a list of authorized distributors and a list of any expressly excluded dealer/resellers. ZeeVee does not warrant equipment purchased through grey market resellers or certain internet resellers.

WHAT THESE WARRANTIES EXCLUDE

Your warranties do NOT cover:

- Labor charges for installation or set-up of the ZeeVee Equipment.
- Repairs or replacement due to misuse, accident, lightning damage, unauthorized repair, power surges, or other causes not within the control of ZeeVee.
- Any modifications or other changes to the ZeeVee Equipment, including but not limited to software or hardware modification in any way other than as expressly authorized by ZeeVee, will void these limited warranties. Except in the case of hardware or software provided by ZeeVee, installing modifications, "hacks," or utilizing service access or "back doors" will void these limited warranties.
- Reception or transmission problems caused by signal conditions, Internet connection problems, or any other communication systems outside the unit.
- Expendable accessories included in ZeeVee Equipment such as batteries.
- Any ZeeVee Equipment that has been modified or adapted to enable it to operate in any country other than the country for which it was designed, manufactured, approved, and/or authorized.

- Any ZeeVee Equipment that has altered or missing serial numbers.
- Any ZeeVee Equipment that has been opened or otherwise tampered with.
- Problems that are directly caused as a result of using any third party accessories, parts or components.

MATERIALS REQUIRED FOR WARRANTY

Please keep your sales receipt and any other documentation showing proof of purchase. Also, keep the original box and packaging material in case you need to return your ZeeVee Equipment.

TO GET WARRANTY SERVICE

Warranty service will be provided by ZeeVee. If you believe you need service for your ZeeVee Equipment, please contact ZeeVee by calling our customer care center at (877)-4ZeeVee; (877)-493-3833. If it is determined that the product needs to be returned for service or exchange, you will receive a Return Material Authorization (RMA) number. Our agents will help you through the process through which you can return the product. ZeeVee is not responsible for customer products received without an RMA number and may reject such products.

TO GET OUT-OF-WARRANTY SERVICE

To obtain out-of-warranty service for your ZeeVee Equipment, please contact ZeeVee by calling our customer care center at (877)-4ZeeVee; (877)-493-3833 for information on the possibility of and any costs for repair or replacement of out-of-warranty products. No agent, company, dealer, distributor, or person is authorized to change, modify, or extend the terms of these warranties in any manner.

LIMITATION OF LIABILITY

In no event will ZeeVee be liable for any amount greater than the retail price of the ZeeVee Equipment. ZeeVee shall not be liable for any incidental or consequential damages (including lost profits) for breach of any express or implied warranty on the ZeeVee Equipment. Some countries and states of the U.S. do not allow the exclusion or limitation of incidental or consequential damages, so the above limitation or exclusion may not apply to you. This warranty gives you specific legal rights and you may also have other rights, which vary from country to country and state to state.



Contact ZeeVee

Support

Contact us for installation and technical support, repairs, and warranty service:

+1 (877) 4ZEEVEE (1.877.493.3833)

support@zeevee.com

Representatives are available from 9:00 AM to 6:00 PM, Monday through Friday (Eastern Time).

Sales

North America:

+1 (347) 851-7364 Phone

sales@zeevee.com

EMEA:

+44 1494 956677 Phone

EMESales@zeevee.com