

---

COBALT<sup>®</sup>

# 9433-EMDE-ADDA

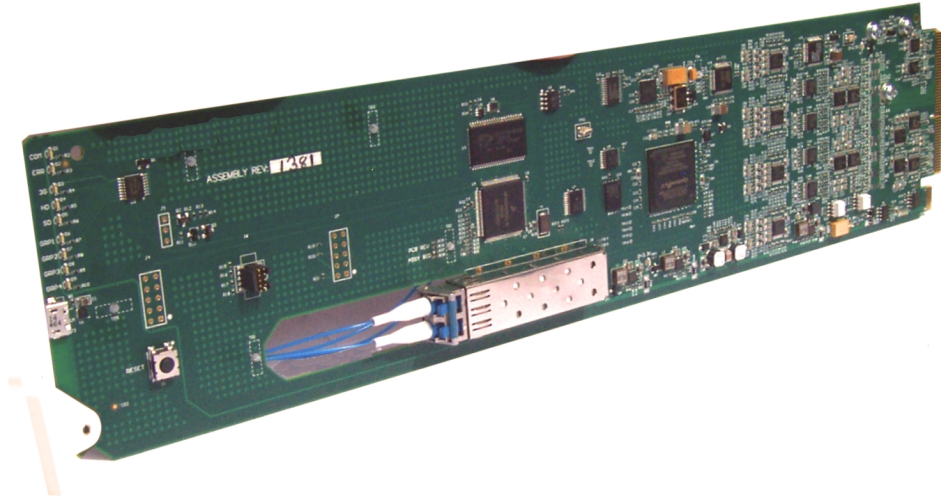

## 3G/HD/SD-SDI Fiber-Optic Converters with 16-Channel AES / 8-Channel Analog Audio Embed / De-Embed

- 9433-EMDE-ADDA-EOOE — Fiber-Optic Transceiver
- 9433-EMDE-ADDA-EO — Fiber-Optic Transmitter
- 9433-EMDE-ADDA-OE — Fiber-Optic Receiver

# *Product Manual*

---

COBALT<sup>®</sup>

**Cobalt Digital Inc.**

2506 Galen Drive  
Champaign, IL 61821  
Voice 217.344.1243 • Fax 217.344.1245  
[www.cobaltdigital.com](http://www.cobaltdigital.com)

---

## Copyright

©Copyright 2018, Cobalt Digital Inc. All Rights Reserved.

Duplication or distribution of this manual and any information contained within is strictly prohibited without the express written permission of Cobalt Digital Inc. This manual and any information contained within, may not be reproduced, distributed, or transmitted in any form, or by any means, for any purpose, without the express written permission of Cobalt Digital Inc. Reproduction or reverse engineering of software used in this device is prohibited.

## Disclaimer

The information in this document has been carefully examined and is believed to be entirely reliable. However, no responsibility is assumed for inaccuracies. Furthermore, Cobalt Digital Inc. reserves the right to make changes to any products herein to improve readability, function, or design. Cobalt Digital Inc. does not assume any liability arising out of the application or use of any product or circuit described herein.

## Trademark Information

**Cobalt**<sup>®</sup> is a registered trademark of Cobalt Digital Inc.

**openGear**<sup>®</sup> is a registered trademark of Ross Video Limited. **DashBoard**<sup>™</sup> is a trademark of Ross Video Limited.

**Dolby**<sup>®</sup> is a registered trademark of Dolby Laboratories, Inc. Other product names or trademarks appearing in this manual are the property of their respective owners.

Congratulations on choosing the Cobalt<sup>®</sup> 9433-EMDE-ADDA 3G/HD/SD-SDI Fiber-Optic Converter with 16-Channel AES / 8-Channel Analog Audio Embed / De-Embed. The 9433-EMDE-ADDA is part of a full line of modular processing and conversion gear for broadcast TV environments. The Cobalt Digital Inc. line includes video decoders and encoders, audio embedders and de-embedders, distribution amplifiers, format converters, remote control systems and much more. Should you have questions pertaining to the installation or operation of your 9433-EMDE-ADDA card, please contact us at the contact information on the front cover.

|  |   |
|--|---|
| <b>Manual No.:</b>                                   | 9433-EMDE-ADDA-OM   |
| <b>Document Version:</b>                             | V1.5  |
| <b>Release Date:</b>                                 | February 8, 2018  |
| <b>Applicable for Firmware Version (or greater):</b> | v1.3.13   |
| <b>Description of product/manual changes:</b>        | - Add option <b>+DT</b> information to manual.<br>- Correct minor errata regarding cabling information. |

# Table of Contents

---

|                  |   |            |
|------------------|---|------------|
| <b>Chapter 1</b> | <b>Introduction .....</b>                                   | <b>1-1</b> |
|                  | Overview .....  | 1-1        |
|                  | 9433-EMDE-ADDA Card Software Versions and this Manual ..... | 1-2        |
|                  | Cobalt Reference Guides .....                               | 1-2        |
|                  | Manual Conventions.....                                     | 1-3        |
|                  | Warnings, Cautions, and Notes .....                         | 1-4        |
|                  | Labeling Symbol Definitions.....                            | 1-4        |
|                  | Safety and Regulatory Summary .....                         | 1-5        |
|                  | Warnings.....   | 1-5        |
|                  | Cautions .....  | 1-5        |
|                  | EMC Compliance Per Market .....                             | 1-5        |
|                  | 9433-EMDE-ADDA Functional Description.....                  | 1-6        |
|                  | 9433-EMDE-ADDA Input/Output Formats.....                    | 1-6        |
|                  | Audio Processor Description.....                            | 1-8        |
|                  | User COM Data Insert/Extract Software Option.....           | 1-8        |
|                  | User Control Interface .....                                | 1-9        |
|                  | 9433-EMDE-ADDA Rear I/O Modules.....                        | 1-11       |
|                  | Technical Specifications.....                               | 1-11       |
|                  | Warranty and Service Information .....                      | 1-14       |
|                  | Cobalt Digital Inc. Limited Warranty.....                   | 1-14       |
|                  | Contact Cobalt Digital Inc.....                             | 1-15       |
| <br>             |   |            |
| <b>Chapter 2</b> | <b>Installation and Setup .....</b>                         | <b>2-1</b> |
|                  | Overview .....  | 2-1        |
|                  | Setting I/O Switches for Analog Audio (1-8) Ports .....     | 2-1        |
|                  | Installing the 9433-EMDE-ADDA Into a Frame Slot.....        | 2-2        |
|                  | Installing a Rear I/O Module .....                          | 2-3        |
|                  | 9433-EMDE-ADDA Rear I/O Modules.....                        | 2-5        |
|                  | Fiber and Balanced Audio Connections .....                  | 2-7        |
|                  | Setting Up 9433-EMDE-ADDA Network Remote Control.....       | 2-8        |
| <br>             |   |            |
| <b>Chapter 3</b> | <b>Operating Instructions.....</b>                          | <b>3-1</b> |
|                  | Overview .....  | 3-1        |
|                  | Control and Display Descriptions.....                       | 3-1        |
|                  | Function Menu/Parameter Overview.....                       | 3-2        |
|                  | DashBoard™ User Interface.....                              | 3-3        |
|                  | Accessing the 9433-EMDE Card via Remote Control.....        | 3-4        |
|                  | Accessing the 9433-EMDE Card Using DashBoard™ .....         | 3-4        |

---

|   |      |
|---|------|
| Checking 9433-EMDE Card Information .....           | 3-6  |
| 9433-EMDE Function Menu List and Descriptions ..... | 3-7  |
| Input Video Controls .....                          | 3-8  |
| Input Audio Status .....                            | 3-8  |
| Output Audio Routing .....                          | 3-9  |
| Ancillary Data Proc Controls .....                  | 3-13 |
| COMM Ports Setup Controls .....                     | 3-14 |
| Troubleshooting .....                               | 3-16 |
| Error and Failure Indicator Overview .....          | 3-16 |
| Basic Troubleshooting Checks.....                   | 3-19 |
| 9433-EMDE Processing Error Troubleshooting.....     | 3-19 |
| Troubleshooting Network/Remote Control Errors.....  | 3-20 |
| In Case of Problems .....                           | 3-20 |

---

# Introduction

## Overview

**Note:** This manual is applicable for models:

- 9433-EMDE-ADDA-EOOE (Fiber Transceiver)
- 9433-EMDE-ADDA-EO (Fiber Transmitter)
- 9433-EMDE-ADDA-OE (Fiber Receiver)

All models function identically except for fiber I/O interface differences. Differences between these models are noted where applicable. In all other aspects, all versions function identically as described in this manual.

This manual provides installation and operating instructions for the 9433-EMDE-ADDA 3G/HD/SD-SDI Fiber-Optic Converters with 16-Channel AES / 8-Channel Analog Audio Embed / De-Embed card (with all models collectively referred to herein as the 9433-EMDE-ADDA).

**This manual** consists of the following chapters:

- **Chapter 1, “Introduction”** – Provides information about this manual and what is covered. Also provides general information regarding the 9433-EMDE-ADDA.
- **Chapter 2, “Installation and Setup”** – Provides instructions for installing the 9433-EMDE-ADDA in a frame, and optionally installing a Rear I/O Module(s).
- **Chapter 3, “Operating Instructions”** – Provides overviews of operating controls and instructions for using the 9433-EMDE-ADDA.

**This chapter** contains the following information:

- **9433-EMDE-ADDA Card Software Versions and this Manual (p. 1-2)**
- **Manual Conventions (p. 1-3)**
- **Safety and Regulatory Summary (p. 1-5)**
- **9433-EMDE-ADDA Functional Description (p. 1-6)**
- **Technical Specifications (p. 1-11)**
- **Warranty and Service Information (p. 1-14)**
- **Contact Cobalt Digital Inc. (p. 1-15)**

## 9433-EMDE-ADDA Card Software Versions and this Manual

When applicable, Cobalt Digital Inc. provides for continual product enhancements through software updates. As such, functions described in this manual may pertain specifically to cards loaded with a particular software build.

The Software Version of your card can be checked by viewing the **Card Info** menu in DashBoard™. See Checking 9433-EMDE Card Information (p. 3-6) in Chapter 3, “Operating Instructions” for more information. You can then check our website for the latest software version currently released for the card as described below.

**Note:** Not all functionality described in this manual may appear on cards with initial software versions.

Check our website and proceed as follows if your card’s software does not match the latest version:

|  |  |
|--|--|
| <p>Card Software <b>earlier</b> than latest version</p>  | <p>Card is not loaded with the latest software. Not all functions and/or specified performance described in this manual may be available.</p> <p>You can update your card with new Update software by going to the <b>Support&gt;Firmware Downloads</b> link at <a href="http://www.cobaltdigital.com">www.cobaltdigital.com</a>. Download “Firmware Update Guide”, which provides simple instructions for downloading the latest firmware for your card onto your computer, and then uploading it to your card through DashBoard™.</p> <p><b>Software updates are field-installed without any need to remove the card from its frame.</b></p>                 |
| <p>Card Software <b>newer</b> than version in manual</p> | <p>A new manual is expediently released whenever a card’s software is updated <b>and specifications and/or functionality have changed</b> as compared to an earlier version (a new manual is not necessarily released if specifications and/or functionality have not changed). A manual earlier than a card’s software version may not completely or accurately describe all functions available for your card.</p> <p>If your card shows features not described in this manual, you can check for the latest manual (if applicable) and download it by going to the card’s web page on <a href="http://www.cobaltdigital.com">www.cobaltdigital.com</a>.</p> |

## Cobalt Reference Guides

From the Cobalt® web home page, go to **Support>Reference Documents** for easy to use guides covering network remote control, card firmware updates, example card processing UI setups and other topics.

---

## Manual Conventions

In this manual, display messages and connectors are shown using the exact name shown on the 9433-EMDE-ADDA itself. Examples are provided below.

- Card-edge display messages are shown like this:



BOOT

- Connector names are shown like this: **SDI IN A**

In this manual, the terms below are applicable as follows:

- **9433-EMDE-ADDA** refers to the 3G/HD/SD-SDI Fiber-Optic Converter with 16-Channel AES / 8-Channel Analog Audio Embed / De-Embed card.
- **Frame** refers to the HPF-9000, OG3-FR, 8321, or similar 20-slot frame that houses Cobalt® or other cards.
- **Device** and/or **Card** refers to a Cobalt® or other card.
- **System** and/or **Video System** refers to the mix of interconnected production and terminal equipment in which the 9433-EMDE-ADDA and other cards operate.
- Functions and/or features that are available only as an option are denoted in this manual like this:



*Option* ➔

## Warnings, Cautions, and Notes

Certain items in this manual are highlighted by special messages. The definitions are provided below.

### Warnings

Warning messages indicate a possible hazard which, if not avoided, could result in personal injury or death.





### Cautions

Caution messages indicate a problem or incorrect practice which, if not avoided, could result in improper operation or damage to the product.

### Notes

Notes provide supplemental information to the accompanying text. Notes typically precede the text to which they apply.

## Labeling Symbol Definitions

|   |   |
|---|---|
|    | <p>Important note regarding product usage. Failure to observe may result in unexpected or incorrect operation.</p>  |
|  | <p>Electronic device or assembly is susceptible to damage from an ESD event. Handle only using appropriate ESD prevention practices.</p> <p>If ESD wrist strap is not available, handle card only by edges and avoid contact with any connectors or components.</p>   |
|  | <p>CLASS 1 LASER PRODUCT<br/>IEC 60825-1:2007<br/>Caution - INVISIBLE LASER RADIATION WHEN OPEN. AVOID EXPOSURE TO THE BEAM.</p>  |
|  | <p>Symbol (WEEE 2002/96/EC)</p> <p>For product disposal, ensure the following:</p> <ul style="list-style-type: none"> <li>• Do not dispose of this product as unsorted municipal waste.</li> <li>• Collect this product separately.</li> <li>• Use collection and return systems available to you.</li> </ul> |



## Safety and Regulatory Summary

### Warnings

#### ! WARNING !

- Do not stare at, or into, broken, or damaged, fibers.
- Do not stare at, or into, optical connectors.
- Only properly trained and authorized personnel should be permitted to perform laser/ fiber optic operations.
- Ensure that appropriate labels are displayed in plain view and in close proximity to the optical port on the protective housing/access panel of the terminal equipment.

#### ! WARNING !

To reduce risk of electric shock do not remove line voltage service barrier cover on frame equipment containing an AC power supply. NO USER SERVICEABLE PARTS INSIDE. REFER SERVICING TO QUALIFIED SERVICE PERSONNEL.

### Cautions

#### CAUTION

This device is intended for environmentally controlled use only in appropriate video terminal equipment operating environments.

#### CAUTION

This product is intended to be a component product of an openGear® frame. Refer to the openGear® frame Owner's Manual for important safety instructions regarding the proper installation and safe operation of the frame as well as its component products.

#### CAUTION

Heat and power distribution requirements within a frame may dictate specific slot placement of cards. Cards with many heat-producing components should be arranged to avoid areas of excess heat build-up, particularly in frames using only convection cooling. The card has a moderate power dissipation (<18 W). As such, avoiding placing the card adjacent to other cards with similar dissipation values if possible.

#### CAUTION

If required, make certain Rear I/O Module(s) is installed before installing the card into the frame slot. Damage to card and/or Rear I/O Module can occur if module installation is attempted with card already installed in slot.

#### CAUTION

If card resists fully engaging in rear I/O module mating connector, check for alignment and proper insertion in slot tracks. Damage to card and/or rear I/O module may occur if improper card insertion is attempted.

### EMC Compliance Per Market

| Market                   | Regulatory Standard or Code   |
|--------------------------|---|
| United States of America | FCC "Code of Federal Regulations" Title 47 Part 15, Subpart B, Class A  |
| Canada                   | ICES-003  |
| International/CE         | CISPR 24:2010<br>IEC 61000-4-2:2008<br>IEC 61000-4-3:2006 with A1:2007 and A2:2010<br>IEC 61000-4-4:2004<br>IEC 61000-4-6:2008<br>CISPR 22:2008 |

---

## 9433-EMDE-ADDA Functional Description

Figure 1-1 shows functional block diagram of the 9433-EMDE-ADDA. The card provides de-embedding or embedding between unbalanced AES-3id and balanced analog audio discrete audio interfaces and SMPTE embedded audio using full 24-bit conversion. In addition to individual per-pair embedding or de-embedding, the card can be used to provide cross-conversions between AES and analog discrete audio. The card also offers the built-in convenience of either coaxial or fiber SDI I/O. Full audio crosspoints allow per-channel gain and routing controls, as well as built-in tone generators. GUI audio meters provide ready assessment of content presence and line-up.

The card is available with discrete CWDM fiber E-O modules providing fully error-free pathological pattern operation is fully compatible with professional fiber video interfaces with numerous CWDM wavelengths that allow the card to be used with CWDM systems. All ancillary data is passed by the card unaffected.

### 9433-EMDE-ADDA Input/Output Formats

The 9433-EMDE-ADDA provides the following inputs and outputs:

- **Inputs:**
  - **3G/HD/SD SDI IN** – 3G/HD/SD-SDI coaxial input.
  - **FIBER IN** – 3G/HD/SD-SDI fiber input.
  - **AES I/O** – Up to 16 channels (8 pairs) of embedding inputs from unbalanced AES sources.
  - **AN\_AUD I/O** – Up to 8 channels of embedding inputs from unbalanced analog audio sources (+24 dBu => 0 dBFS).
- **Outputs:**
  - **3G/HD/SD-SDI OUT** – 3G/HD/SD-SDI coaxial video output.
  - **FIBER OUT** – 3G/HD/SD-SDI fiber output.
  - **AES I/O** – Up to 16 channels (8 pairs) of de-embedded outputs to unbalanced AES.
  - **AN\_AUD I/O** – Up to 8 channels of de-embedding outputs to unbalanced analog audio (0 dBFS => +24 dBu).

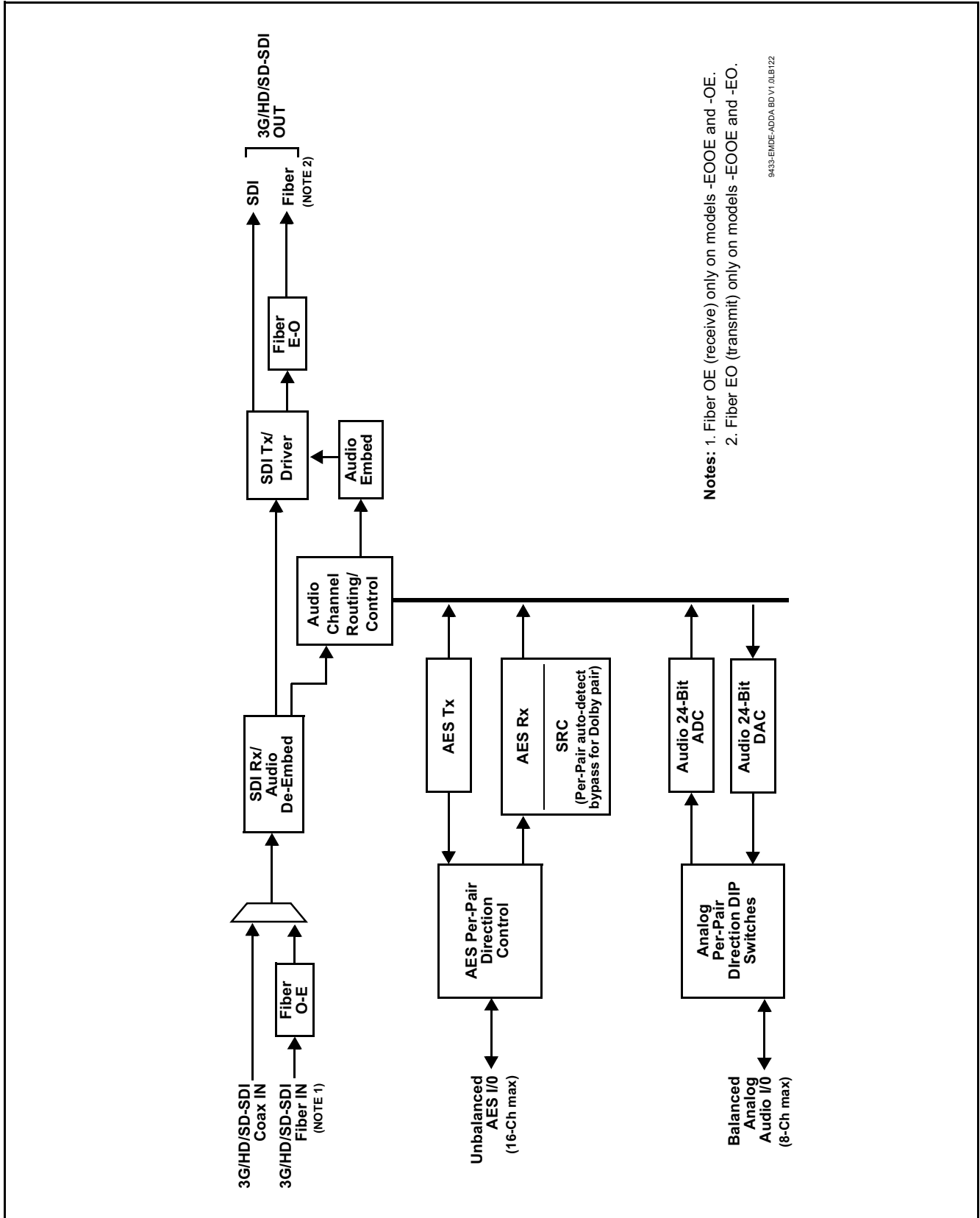

Figure 1-1 9433-EMDE-ADDA Functional Block Diagrams

---

## Audio Processor Description

The audio processor operates as an internal audio router. This function chooses from the following inputs:

- 16 channels of embedded audio from the SDI video input (default 1-to-1 routing to SDI output).
- Up to 16 channels (8 pairs) of unbalanced (AES-3id) audio inputs or outputs between AES I/O ports and embedded or other audio (pair direction is controlled via DashBoard controls).
- Up to 8 channels of balanced analog audio inputs or outputs between analog input/outputs and embedded or other audio. (Analog audio port direction is set using per-channel direction control DIP switches.)

The audio processing subsection is built around a card internal 16-channel audio bus. Audio embed adaptive SRC allows asynchronous 48 kHz AES audio to automatically sync with program video 48 kHz timing for glitch-free embedding. Individual, per-pair SRC auto-detects and disables SRC when a Dolby pair is detected on an input pair.

Audio status (presence, dBFS signal levels) is displayed for each embedded and AES input channel.

## User COM Data Insert/Extract Software Option

Option **+DT** offers user serial data insertion and extraction from SDI streams using user accessible DID/SDID locations. This allows serial data handled by the card to be embedded or de-embedded on an unused DID/SDID.

This offers a very convenient self-contained transport within the program stream physical media, greatly simplifying this data transfer workflow. This function provides full VANC/HANC ancillary data de-embedding and embedding for 3G/HD/SD-SDI streams. Direct access to DID and SDID locations allows extraction or insertion of user data such as camera PTZ, SCTE 104, closed-captioning read/insert, GPI/GPO via ANC, or other specialized user payloads. Data can be extracted and inserted within the card (Bridge mode), or inserted and/or extracted to and from the card via serial interfaces connecting to external devices/systems.

When a card is licensed for **+DT**, a **COM Routing** DashBoard tab also appears that allows setting of serial mode, insertion and extraction control, parity, bit rate and other serial comm aspects.

---

## User Control Interface

Figure 1-2 shows the user control interface options for the 9433-EMDE-ADDA. These options are individually described below.

**Note:** All user control interfaces described here are cross-compatible and can operate together as desired. Where applicable, any control setting change made using a particular user interface is reflected on any other connected interface.

- **DashBoard™ User Interface** – Using DashBoard™, the 9433-EMDE-ADDA and other cards installed in openGear®<sup>1</sup> frames can be controlled from a computer and monitor.

DashBoard™ allows users to view all frames on a network with control and monitoring for all populated slots inside a frame. This simplifies the setup and use of numerous modules in a large installation and offers the ability to centralize monitoring. Cards define their controllable parameters to DashBoard™, so the control interface is always up to date.

The DashBoard™ software can be downloaded from the Cobalt Digital Inc. website: [www.cobaltdigital.com](http://www.cobaltdigital.com) (enter “DashBoard” in the search window). The DashBoard™ user interface is described in Chapter 3, “Operating Instructions”.

- **Cobalt® OGCP-9000 and OGCP-9000/CC Remote Control Panels** – The OGCP-9000 and OGCP-9000/CC Remote Control Panels conveniently and intuitively provide parameter monitor and control of the 9433-EMDE-ADDA and other video and audio processing terminal equipment meeting the open-architecture Cobalt® cards for openGear™ standard.

In addition to circumventing the need for a computer to monitor and control signal processing cards, the Control Panels allow quick and intuitive access to hundreds of cards in a facility, and can monitor and allow adjustment of multiple parameters at one time.

The Remote Control Panels are totally compatible with the openGear™ control software DashBoard™; any changes made with either system are reflected on the other. The Remote Control Panel user interface is described in Chapter 3, “Operating Instructions”.

1. openGear® is a registered trademark of Ross Video Limited. DashBoard™ is a trademark of Ross Video Limited.

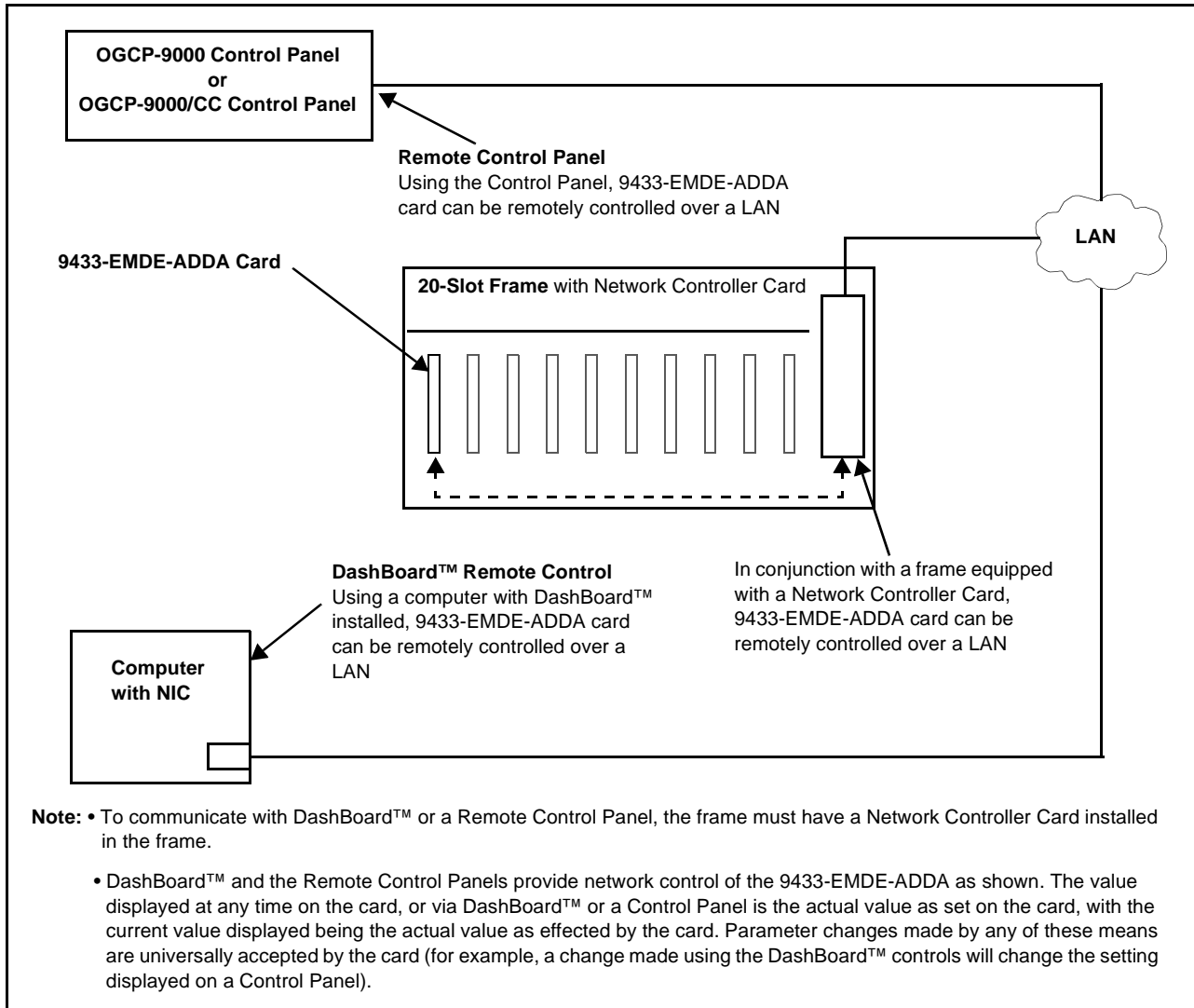

**Figure 1-2 9433-EMDE-ADDA User Control Interface**

**Note:** If network remote control is to be used for the frame and the frame has not yet been set up for remote control, Cobalt® reference guide **Remote Control User Guide (PN 900RCS-RM)** provides thorough information and step-by-step instructions for setting up network remote control of Cobalt® cards using Dashboard™. (Cobalt® OGCP-9000 and OGCP-9000/CC Remote Control Panel product manuals have complete instructions for setting up remote control using a Remote Control Panel.)

Download a copy of this guide by clicking on the **Support>Reference Documents** link at [www.cobaltdigital.com](http://www.cobaltdigital.com) and then select Dashboard Remote Control Setup Guide as a download, or contact Cobalt® as listed in Contact Cobalt Digital Inc. (p. 1-15).

## 9433-EMDE-ADDA Rear I/O Modules

The 9433-EMDE-ADDA physically interfaces to system video connections at the rear of its frame using a Rear I/O Module.

All inputs and outputs shown in the 9433-EMDE-ADDA Functional Block Diagrams (Figure 1-1) enter and exit the card via the card edge backplane connector. The Rear I/O Module breaks out the 9433-EMDE-ADDA card edge connections to BNC and other connectors that interface with other components and systems in the signal chain.

The full assortment of 9433-EMDE-ADDA Rear I/O Modules is shown and described in 9433-EMDE-ADDA Rear I/O Modules (p. 2-5) in Chapter 2, “Installation and Setup”.

## Technical Specifications

Table 1-1 lists the technical specifications for the 9433-EMDE-ADDA 3G/HD/SD-SDI Fiber-Optic Converters with 16-Channel AES / 8-Channel Analog Audio Embed / De-Embed cards.

**Table 1-1 Technical Specifications**

| Item  | Characteristic  |
|---|---|
| Part number, nomenclature   | <ul style="list-style-type: none"> <li>• 9433-EMDE-ADDA-EOOE 3G/HD/SD-SDI Fiber-Optic Transceiver with 16-Channel AES / 8-Channel Analog Audio Embed / De-Embed</li> <li>• 9433-EMDE-ADDA-EO 3G/HD/SD-SDI Fiber-Optic Transmitter with 16-Channel AES / 8-Channel Analog Audio Embed / De-Embed</li> <li>• 9433-EMDE-ADDA-OE 3G/HD/SD-SDI Fiber-Optic Receiver with 16-Channel AES / 8-Channel Analog Audio Embed / De-Embed</li> </ul> |
| Installation/usage environment  | Intended for installation and usage in frame meeting openGear™ modular system definition.   |
| Power consumption   | < 18 Watts maximum  |
| Installation Density  | Up to 20 cards per 20-slot frame  |
| Environmental:<br>Operating temperature:<br>Relative humidity (operating or storage): | 32° – 104° F (0° – 40° C)<br>< 95%, non-condensing  |
| Frame communication   | 10/100 Mbps Ethernet with Auto-MDIX.  |
| Indicators  | Card edge indicators as follows: <ul style="list-style-type: none"> <li>• Status/Error LED indicator</li> <li>• Input Presence LED indicators</li> </ul>  |

Table 1-1 Technical Specifications — continued

| Item  | Characteristic  |
|---|---|
| SDI/Fiber Inputs/Outputs<br>(fiber port presence per EOOE, OE, or EO model) | <p>(1) 75Ω BNC inputs<br/>(1) 75Ω BNC output</p> <p>SDI Receive Cable Length (1694A): 120m/180m/360m (3G/HD/SD)</p> <p>SDI Return Loss: &gt;15 dB up to 1.485 GHz; &gt;10 dB up to 2.970 GHz</p> <p>Note: SDI Return loss and receive cable length are affected by rear I/O module used. Specifications represent typical performance.</p> <p>Alignment Jitter: 3G/HD/SD: &lt; 0.3/0.2/0.2 UI</p> <p>Timing Jitter: 3G/HD/SD: &lt; 2.0/1.0/0.2 UI</p> <p>(1) Fiber input; LC connector<br/>(1) Fiber output; LC connector</p> <p>Fiber Wavelength, Tx: 1310 nm</p> <p>Fiber Rx Sensitivity: -23 dBm; 1260 to 1620 nm</p> <p>Fiber Tx Power: -5.0 dBm (min)</p> <p>SDI Formats Supported: SMPTE 259M, SMPTE 292M, SMPTE 424M</p> |
| Model -EOOE-WX (CWDM) Transmit Wavelengths and Codes                        | <p>Available wavelengths (in nm) are as follows: 1270, 1290, 1310, 1330, 1350, 1410, 1430, 1450, 1470, 1490, 1510, 1530, 1550, 1570, 1590, 1610.</p> <p>In “WX” places in part number, code for wavelengths in each place as listed below:</p> <p>-27: 1270nm    -29: 1290nm    -31: 1310nm<br/> -33: 1330nm    -35: 1350nm    -41: 1410nm<br/> -43: 1430nm    -45: 1450nm    -47: 1470nm<br/> -49: 1490nm    -51: 1510nm    -53: 1530nm<br/> -55: 1550nm    -57: 1570nm    -59: 1590nm<br/> -61: 1610nm</p>  |
| Audio Conversion Format   | 48 kHz sampling, 24-bit. Analog audio I/O conforms to +24 dBu <=> 0 dBFS  |



**Table 1-1 Technical Specifications — continued**

| Item                            | Characteristic  |
|---------------------------------|---|
| Discrete Audio Inputs/Outputs   | (8) Unbalanced AES (AES-3id; 16-ch) with per-pair port direction controls<br>(8) Balanced Analog Audio with per-pair port direction controls  |
| Analog Audio I/O Specifications | Input Impedance: >10 kΩ<br>Reference Level: -20 dBFS<br>Nominal Level: +4 dBu<br>Input Clip Level: +24 dBu (0 dBFS)<br>Freq. Response: ±0.2 dB (20 Hz to 20 kHz)<br>SNR: 115 dB (A weighted)<br>THD+N: -96 dB (20 Hz to 10 kHz)<br>Crosstalk: -106 dB (20 Hz to 20 kHz)<br>Output Impedance: < 50 Ω<br>Max Output Level: +24 dBu (0 dBFS) |

---

## Warranty and Service Information

### Cobalt Digital Inc. Limited Warranty

This product is warranted to be free from defects in material and workmanship for a period of five (5) years from the date of shipment to the original purchaser, except that 4000, 5000, 6000, 8000 series power supplies, and Dolby® modules (where applicable) are warranted to be free from defects in material and workmanship for a period of one (1) year.

Cobalt Digital Inc.'s ("Cobalt") sole obligation under this warranty shall be limited to, at its option, (i) the repair or (ii) replacement of the product, and the determination of whether a defect is covered under this limited warranty shall be made at the sole discretion of Cobalt.

This limited warranty applies only to the original end-purchaser of the product, and is not assignable or transferrable therefrom. This warranty is limited to defects in material and workmanship, and shall not apply to acts of God, accidents, or negligence on behalf of the purchaser, and shall be voided upon the misuse, abuse, alteration, or modification of the product. Only Cobalt authorized factory representatives are authorized to make repairs to the product, and any unauthorized attempt to repair this product shall immediately void the warranty. Please contact Cobalt Technical Support for more information.

To facilitate the resolution of warranty related issues, Cobalt recommends registering the product by completing and returning a product registration form. In the event of a warrantable defect, the purchaser shall notify Cobalt with a description of the problem, and Cobalt shall provide the purchaser with a Return Material Authorization ("RMA"). For return, defective products should be double boxed, and sufficiently protected, in the original packaging, or equivalent, and shipped to the Cobalt Factory Service Center, postage prepaid and insured for the purchase price. The purchaser should include the RMA number, description of the problem encountered, date purchased, name of dealer purchased from, and serial number with the shipment.

#### **Cobalt Digital Inc. Factory Service Center**

2506 Galen Drive

Champaign, IL 61821 USA

www.cobaltdigital.com

Office: (217) 344-1243

Fax: (217) 344-1245

Email: info@cobaltdigital.com

THIS LIMITED WARRANTY IS EXPRESSLY IN LIEU OF ALL OTHER WARRANTIES EXPRESSED OR IMPLIED, INCLUDING THE WARRANTIES OF MERCHANTABILITY AND FITNESS FOR A PARTICULAR PURPOSE AND OF ALL OTHER OBLIGATIONS OR LIABILITIES ON COBALT'S PART. ANY SOFTWARE PROVIDED WITH, OR FOR USE WITH, THE PRODUCT IS PROVIDED "AS IS." THE BUYER OF THE PRODUCT ACKNOWLEDGES THAT NO OTHER REPRESENTATIONS WERE MADE OR RELIED UPON WITH RESPECT TO THE QUALITY AND FUNCTION OF THE GOODS HEREIN SOLD. COBALT PRODUCTS ARE NOT AUTHORIZED FOR USE IN LIFE SUPPORT APPLICATIONS.

COBALT'S LIABILITY, WHETHER IN CONTRACT, TORT, WARRANTY, OR OTHERWISE, IS LIMITED TO THE REPAIR OR REPLACEMENT, AT ITS OPTION, OF ANY DEFECTIVE PRODUCT, AND SHALL IN NO EVENT INCLUDE SPECIAL, INDIRECT, INCIDENTAL, OR CONSEQUENTIAL DAMAGES (INCLUDING LOST PROFITS), EVEN IF IT HAS BEEN ADVISED OF THE POSSIBILITY OF SUCH DAMAGES.

---

## Contact Cobalt Digital Inc.

Feel free to contact our thorough and professional support representatives for any of the following:

- Name and address of your local dealer
- Product information and pricing
- Technical support
- Upcoming trade show information

|                             |  |
|-----------------------------|--|
| <b>Phone:</b>               | (217) 344-1243   |
| <b>Fax:</b>                 | (217) 344-1245   |
| <b>Web:</b>                 | <a href="http://www.cobaltdigital.com">www.cobaltdigital.com</a> |
| <b>General Information:</b> | info@cobaltdigital.com   |
| <b>Technical Support:</b>   | support@cobaltdigital.com  |

---

**This page intentionally blank**

# Installation and Setup

## Overview

This chapter contains the following information:

- Setting I/O Switches for Analog Audio (1-8) Ports (p. 2-1)
- Installing the 9433-EMDE-ADDA Into a Frame Slot (p. 2-2)
- Installing a Rear I/O Module (p. 2-3)
- Fiber and Balanced Audio Connections (p. 2-7)
- Setting Up 9433-EMDE-ADDA Network Remote Control (p. 2-8)

## Setting I/O Switches for Analog Audio (1-8) Ports

Each analog channel (**AN-AUD I/O 1** thru **AN-AUD I/O 8**) is configurable as an input or output using the card DIP switches as shown in Figure 2-1.

**Note:** All switches are set as **IN** (inputs) as factory default.

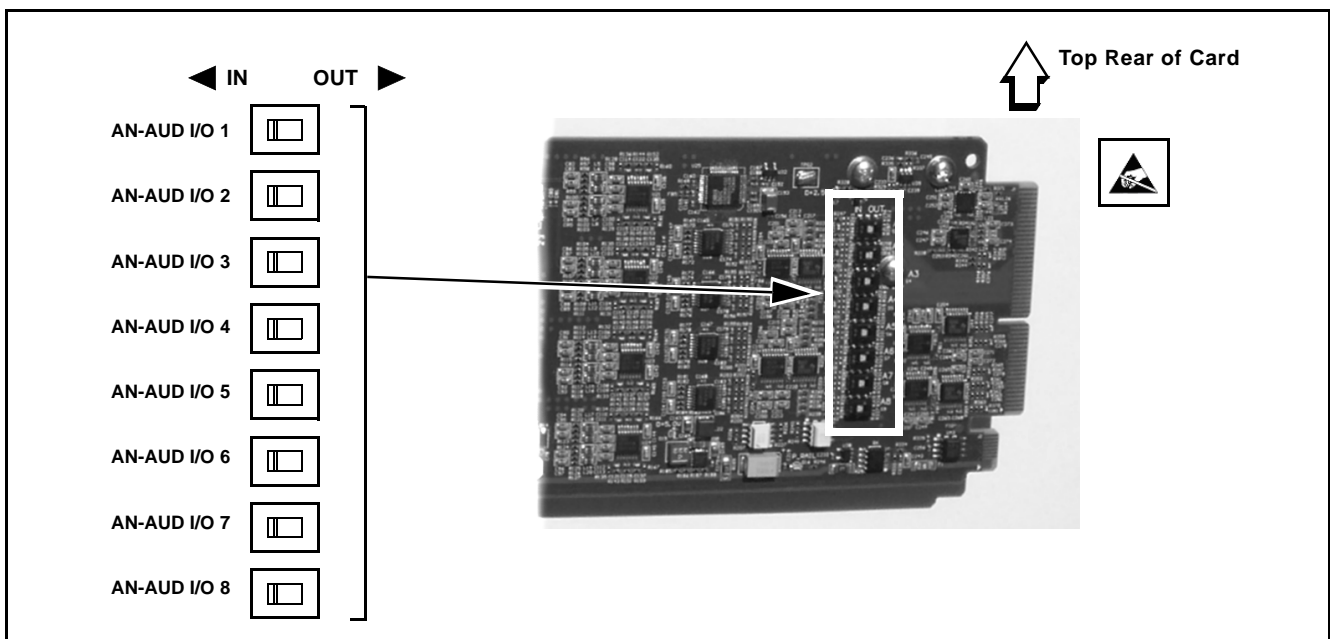

Figure 2-1 AN-AUD I/O (1-8) Direction Switches

## Installing the 9433-EMDE-ADDA Into a Frame Slot

### CAUTION

Heat and power distribution requirements within a frame may dictate specific slot placement of cards. Cards with many heat-producing components should be arranged to avoid areas of excess heat build-up, particularly in frames using only convection cooling. The card has a moderate power dissipation (<18 W). As such, avoiding placing the card adjacent to other cards with similar dissipation values if possible.

### CAUTION



This device contains semiconductor devices which are susceptible to serious damage from Electrostatic Discharge (ESD). ESD damage may not be immediately apparent and can affect the long-term reliability of the device.

Avoid handling circuit boards in high static environments such as carpeted areas, and when wearing synthetic fiber clothing. Always use proper ESD handling precautions and equipment when working on circuit boards and related equipment.

**Note:** If installing the card in a slot with no rear I/O module, a Rear I/O Module is required before cabling can be connected. Refer to Installing a Rear I/O Module (p. 2-3) for rear I/O module installation procedure.

### CAUTION

If required, make certain Rear I/O Module(s) is installed before installing the card into the frame slot. Damage to card and/or Rear I/O Module can occur if module installation is attempted with card already installed in slot.

- Note:**
- Check the packaging in which the card was shipped for any extra items such as a Rear I/O Module connection label. In some cases, this label is shipped with the card and to be installed on the Rear I/O connector bank corresponding to the slot location of the card.
  - **Before installing card or rear module**, if not already fitted make certain rear module is fitted with fiber blindmate adapter and all protective fiber port plugs have been removed. See Fiber and Balanced Audio Connections (p. 2-7) for instructions.

Install the card into a frame slot as follows:

1. Determine the slot in which the card is to be installed.
2. Open the frame front access panel.
3. While holding the card by the card edges, align the card such that the plastic ejector tab is on the bottom.
4. Align the card with the top and bottom guides of the slot in which the card is being installed.

5. Gradually slide the card into the slot. When resistance is noticed, gently continue pushing the card until its rear printed circuit edge terminals engage fully into the rear I/O module mating connector.

**CAUTION**

If card resists fully engaging in rear I/O module mating connector, check for alignment and proper insertion in slot tracks. Damage to card and/or rear I/O module may occur if improper card insertion is attempted.

6. Verify that the card is fully engaged in rear I/O module mating connector.
7. Close the frame front access panel.
8. Connect the input and output cables as shown in 9433-EMDE-ADDA Rear I/O Modules (p. 2-5).
9. Repeat steps 1 through 8 for other cards.

- Note:**
- The card BNC inputs are internally 75-ohm terminated. It is not necessary to terminate unused BNC inputs or outputs.
  - To remove a card, press down on the ejector tab to unseat the card from the rear I/O module mating connector. Evenly draw the card from its slot.

10. If network remote control is to be used for the frame and the frame has not yet been set up for remote control, perform setup in accordance with Setting Up 9433-EMDE-ADDA Network Remote Control (p. 2-8).

- Note:** If installing a card in a frame already equipped for, and connected to DashBoard™, no network setup is required for the card. The card will be discovered by DashBoard™ and be ready for use.

## Installing a Rear I/O Module

- Note:**
- This procedure is applicable **only if a Rear I/O Module is not currently installed** in the slot where the card is to be installed. If installing the card in a slot already equipped with a suitable I/O module, omit this procedure.
  - **Before installing card or rear module**, if not already fitted make certain rear module is fitted with fiber blindmate adapter and all protective fiber port plugs have been removed. See Fiber and Balanced Audio Connections (p. 2-7) for instructions.

Install a Rear I/O Module as follows:

1. On the frame, determine the slot in which the card is to be installed.
2. In the mounting area corresponding to the slot location, install Rear I/O Module as shown in Figure 2-2.

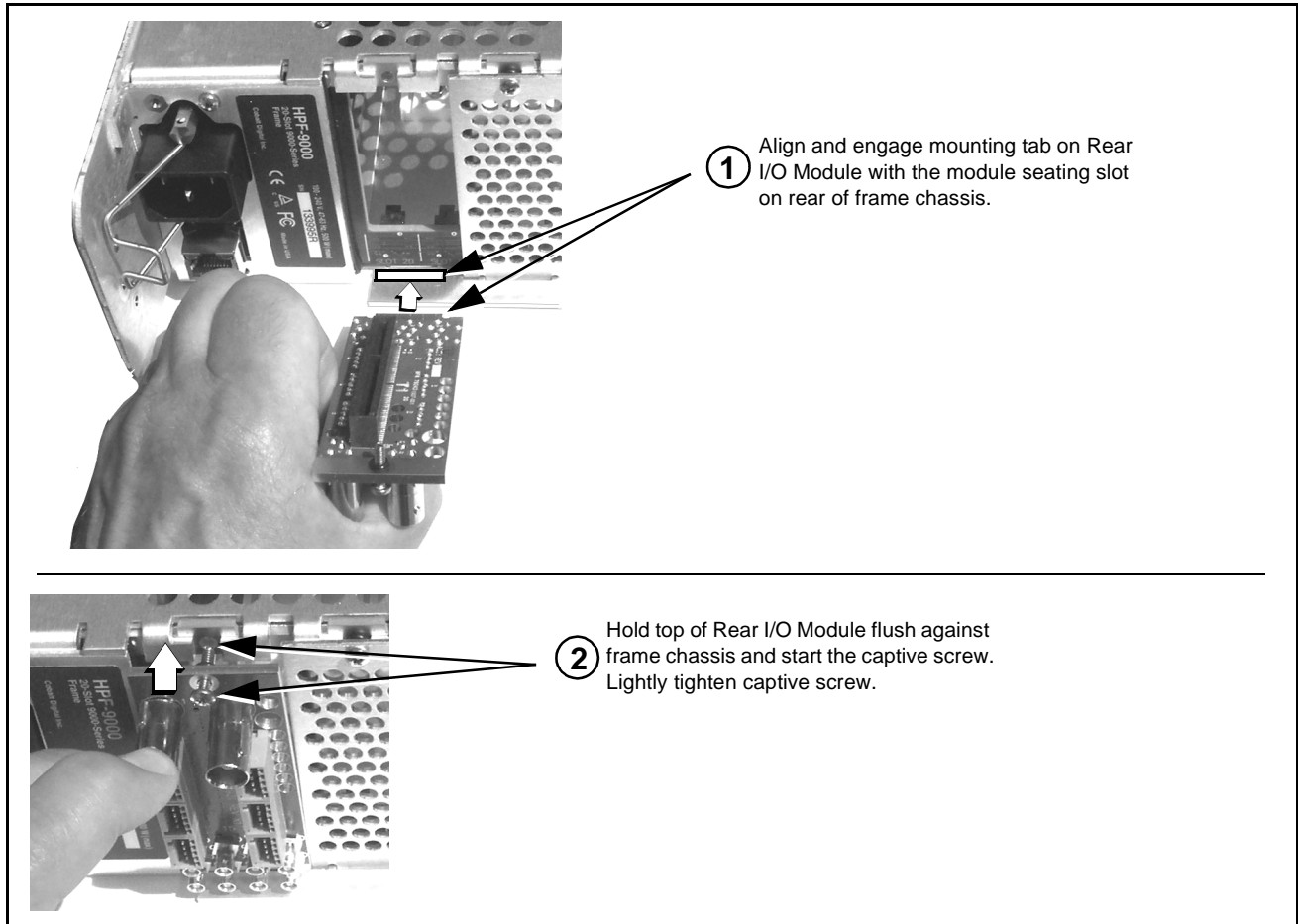

**Figure 2-2 Rear I/O Module Installation**



### 9433-EMDE-ADDA Rear I/O Modules

Table 2-1 shows and describes the full assortment of Rear I/O Modules specifically for use with the 9433-EMDE-ADDA.

**Notes:** Rear I/O Modules equipped with multi-pin connectors are supplied with removable terminal block adapters. For clarity, the adapters are omitted in the drawings below.

**Table 2-1** 9433-EMDE-ADDA Rear I/O Modules





| 9433-EMDE-ADDA Rear I/O Module  | Description  |
|---|--|
|  <p><b>CLASS 1 LASER PRODUCT - IEC 60825-1:2007. Never look into fiber connector or cable end of device transmitting an optical signal. The transmitted light is not visible and can cause permanent eye damage. Do not perform connection/disconnection with sending or receiving device powered.</b></p>   |  |
| <p><b>Note:</b> Rear module fiber port directions (IN, OUT) are as shown below. When used on -EO or -OE models, Fiber <b>IN</b> or Fiber <b>OUT</b> ports are respectively NC.</p>  |  |
| <p><b>RM20-9433EMDE-C</b></p> <p>The diagram shows the rear panel of the RM20-9433EMDE-C module. At the top left are two BNC ports labeled SDI IN and SDI OUT. To their right are two LC fiber ports labeled FIBER IN and FIBER OUT. Below these are two 8-pin DIN connectors for AN-AUD I/O, each with four pairs of pins labeled 1-4 and 5-8. At the bottom are eight circular ports for UNBAL AES I/O, numbered 1 through 8.</p> | <p>Provides the following connections:</p> <ul style="list-style-type: none"> <li>• One 3G/HD/SD-SDI coaxial input BNC (<b>SDI IN</b>)</li> <li>• One 3G/HD/SD-SDI fiber LC input (<b>FIBER IN</b>)</li> <li>• Eight AES-3id unbalanced audio input/outputs (<b>UNBAL AES I/O 1</b> thru <b>AES I/O 8</b>)</li> <li>• Eight balanced analog audio input/outputs (<b>AN-AUD I/O 1</b> thru <b>AN-AUD I/O 8</b>)</li> <li>• One 3G/HD/SD-SDI coaxial output BNC (<b>SDI OUT</b>)</li> <li>• One 3G/HD/SD-SDI fiber LC output (<b>FIBER OUT</b>)</li> </ul> <p><b>Note:</b> AES coaxial connectors are DIN1.0/2.3 or HD-BNC. Available equipped with High-Density BNC (HDBNC) or DIN1.0/2.3 connectors as: RM20-9433EMDE-C-HDBNC or RM20-9433EMDE-C-DIN, respectively.</p> <p> In previous manual version 1.2, the <b>UNBAL AES I/O</b> port numbering was labeled incorrect. Use the port numbering shown here.</p> |

Table 2-1 9433-EMDE-ADDA Rear I/O Modules — continued

| 9433-EMDE-ADDA Rear I/O Module   | Description  |
|--|--|
| <p><b>RM20-9433EMDE-D</b></p>  <p>1 - RS422 RX+<br/>                 2 - RS422 TX+<br/>                 5 - GND<br/>                 6 - RS232 RX / RS422 RX-<br/>                 7 - RS232 TX / RS422 TX-<br/>                 14 - AES I/O 1<br/>                 15 - AES I/O 2<br/>                 Other conns NC</p> | <p>Provides the following connections:</p> <ul style="list-style-type: none"> <li>• One 3G/HD/SD-SDI coaxial input BNC (<b>SDI IN</b>)</li> <li>• One 3G/HD/SD-SDI fiber LC input (<b>FIBER IN</b>)</li> <li>• Eight balanced analog audio input/outputs (<b>AN-AUD I/O 1</b> thru <b>AN-AUD I/O 8</b>)</li> <li>• Two AES-3id unbalanced audio input/outputs, serial Rx/Tx via HD-15 connector (per illustration)</li> <li>• One 3G/HD/SD-SDI coaxial output BNC (<b>SDI OUT</b>)</li> <li>• One 3G/HD/SD-SDI fiber LC output (<b>FIBER OUT</b>)</li> </ul> |
|  <p>**SAMPLE-NOT FOR USE**</p>   | <p>Due to the density of connector placement on Rear Modules using high-density connectors (e.g., RM20-9001-B/S-DIN), these modules use a QR barcode label instead a regular label. Simply scan the image with a smart phone and a link to the rear module label (as shown in our catalog) will appear. (Smart phone must have a QR reader app such as QuickMark QR Code Reader or equivalent.)</p> <p>Not all devices may be able to acquire the image. If this occurs, use the device to access the web page for card/rear module to view the diagram.</p> |

## Fiber and Balanced Audio Connections

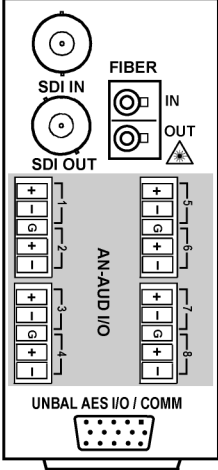
Figure 2-3 shows connections to the card multi-pin terminal block connectors. These connectors are used for card balanced audio connections. Figure 2-3 also shows how to install the blindmate fiber adapter to the rear module.

**Note:** It is preferable to wire connections to plugs oriented as shown in Figure 2-3 rather than assessing orientation on rear module connectors. Note that the orientation of rear module multi-pin audio connectors is not necessarily consistent within a rear module, or between different rear modules. If wiring is first connected to plug oriented as shown here, the electrical orientation will be correct regardless of rear module connector orientation.

Removable multipin plug  
view oriented with **orange  
release buttons to the left**

Rear module  
PCB connector

Release  
(orange) button

### Balanced Audio Multipin Connections

**Note:**

- Press orange release button to insert wires into holes.
- Wire thinner than 24 AWG may not be securely retained in connector.
- The **G** terminal is shared by both ports. Depending on wire gauge, two wires may not fit in insertion hole. In this case, make the bridge connection external to the multipin plug.
- Unbalanced analog connections can be connected across the **+** and **G** terminals. Note that this connection will experience a 6 dB voltage gain loss. Adjust gain for these connections accordingly.

---

### Fiber Adapter and Cable Connections

**Installing Adapter on Card Fiber Port**

The card fiber ports use a blindmate adapter which allows the card to be removed (leaving the rear module intact and installed) without disturbing the fiber connections to the rear module. **Before installing rear module or card, first install adapter to rear module as shown below.**

Retaining tabs (2)

Adapter, with:  
• cable locking slots facing right  
• metal retaining tabs locking adapter to rear module PCB

- 1 Remove protective plugs from adapter and fiber cable ports.
- 2 Position adapter such that metal retaining tabs are at rear side of rear module, and cable locking slots on adapter are facing right.
- 3 From rear of rear module, insert the adapter into the rear module cutout hole, making certain the two metal retaining tabs lock the adapter into place. If tabs do not lock the adapter, spread the tabs out slightly.
- 4 Install the rear module into the frame.
- 5 Connect all cabling and fiber cables to the rear module.
- 6 Install the card into the frame.

Figure 2-3 Fiber and Balanced Audio Connections

## Setting Up 9433-EMDE-ADDA Network Remote Control

Perform remote control setup in accordance with Cobalt® reference guide “Remote Control User Guide” (PN 9000RCS-RM).

- Note:**
- If network remote control is to be used for the frame and the frame has not yet been set up for remote control, Cobalt® reference guide **Remote Control User Guide (PN 9000RCS-RM)** provides thorough information and step-by-step instructions for setting up network remote control of Cobalt® cards using DashBoard™. (Cobalt® OGCP-9000 and OGCP-9000/CC Remote Control Panel product manuals have complete instructions for setting up remote control using a Remote Control Panel.)

Download a copy of this guide by clicking on the **Support>Reference Documents** link at [www.cobaltdigital.com](http://www.cobaltdigital.com) and then select DashBoard Remote Control Setup Guide as a download, or contact Cobalt® as listed in Contact Cobalt Digital Inc. (p. 1-15).

- If installing a card in a frame already equipped for, and connected to DashBoard™, no network setup is required for the card. The card will be discovered by DashBoard™ and be ready for use.

---

# Operating Instructions

## Overview

If you are already familiar with using DashBoard or a Cobalt Remote Control Panel to control Cobalt cards, please skip to 9433-EMDE Function Menu List and Descriptions (p. 3-7).

This chapter contains the following information:

- Control and Display Descriptions (p. 3-1)
- Accessing the 9433-EMDE Card via Remote Control (p. 3-4)
- Checking 9433-EMDE Card Information (p. 3-6)
- 9433-EMDE Function Menu List and Descriptions (p. 3-7)
- Troubleshooting (p. 3-16)

## Control and Display Descriptions

This section describes the user interface controls, indicators, and displays for using the 9433-EMDE-ADDA card. The 9433-EMDE-ADDA functions can be accessed and controlled using any of the user interfaces described here.

The format in which the 9433-EMDE-ADDA functional controls, indicators, and displays appear and are used varies depending on the user interface being used. Regardless of the user interface being used, access to the 9433-EMDE-ADDA functions (and the controls, indicators, and displays related to a particular function) follows a general arrangement of Function Menus under which related controls can be accessed (as described in Function Menu/Parameter Overview below).

**Note:** When a setting is changed, settings displayed on DashBoard™ (or a Remote Control Panel) are the settings as effected by the card itself and reported back to the remote control; the value displayed at any time is the actual value as set on the card.

## Function Menu/Parameter Overview

The functions and related parameters available on the 9433-EMDE-ADDA card are organized into function **menus**, which consist of parameter groups as shown below.

Figure 3-1 shows how the 9433-EMDE card and its menus are organized, and also provides an overview of how navigation is performed between cards, function menus, and parameters.

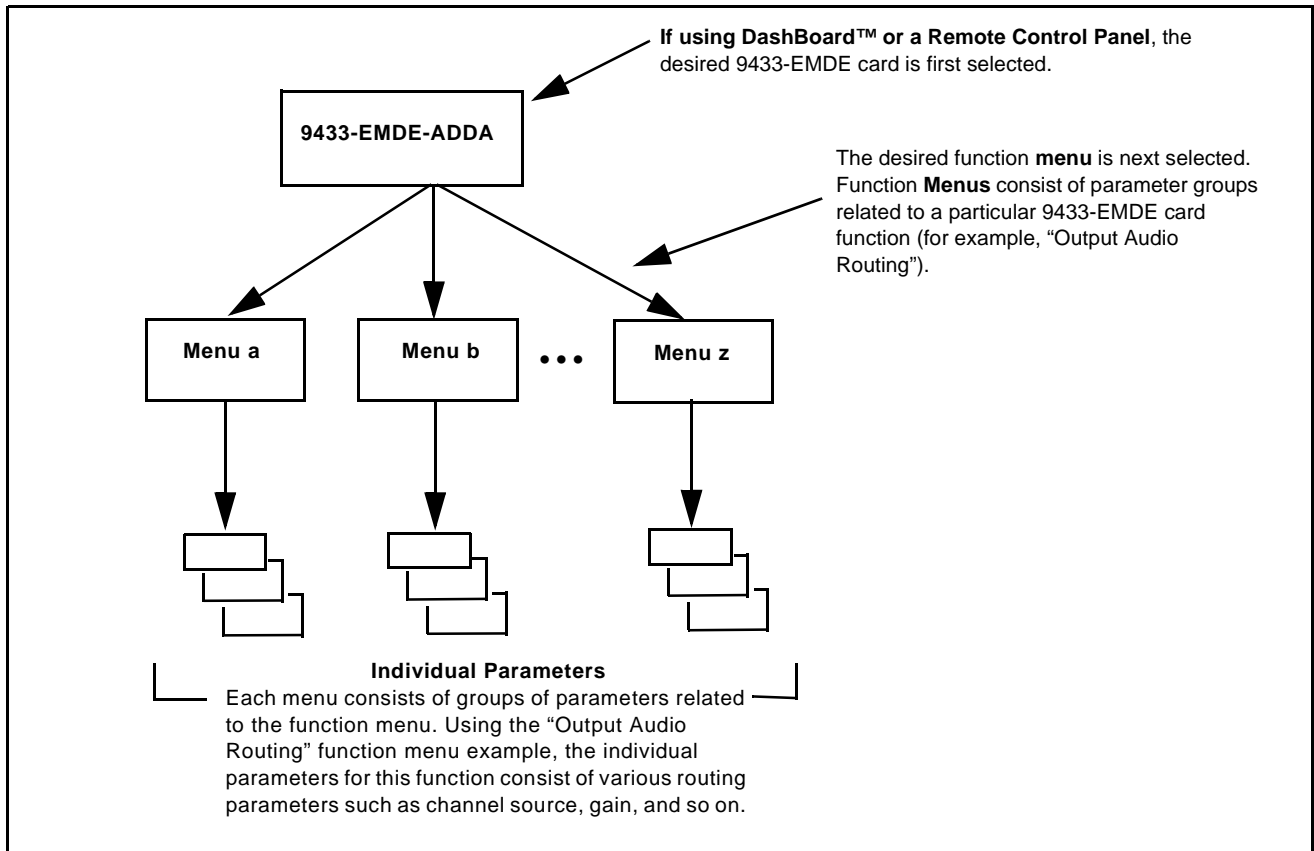

**Figure 3-1 Function Menu/Parameter Overview**

DashBoard™ User Interface

(See Figure 3-2.) The card function menus are organized in DashBoard™ using tabs. When a tab is selected, each parametric control or selection list item associated with the function is displayed. Scalar (numeric) parametric values can then be adjusted as desired using the GUI slider controls. Items in a list can then be selected using GUI drop-down lists.

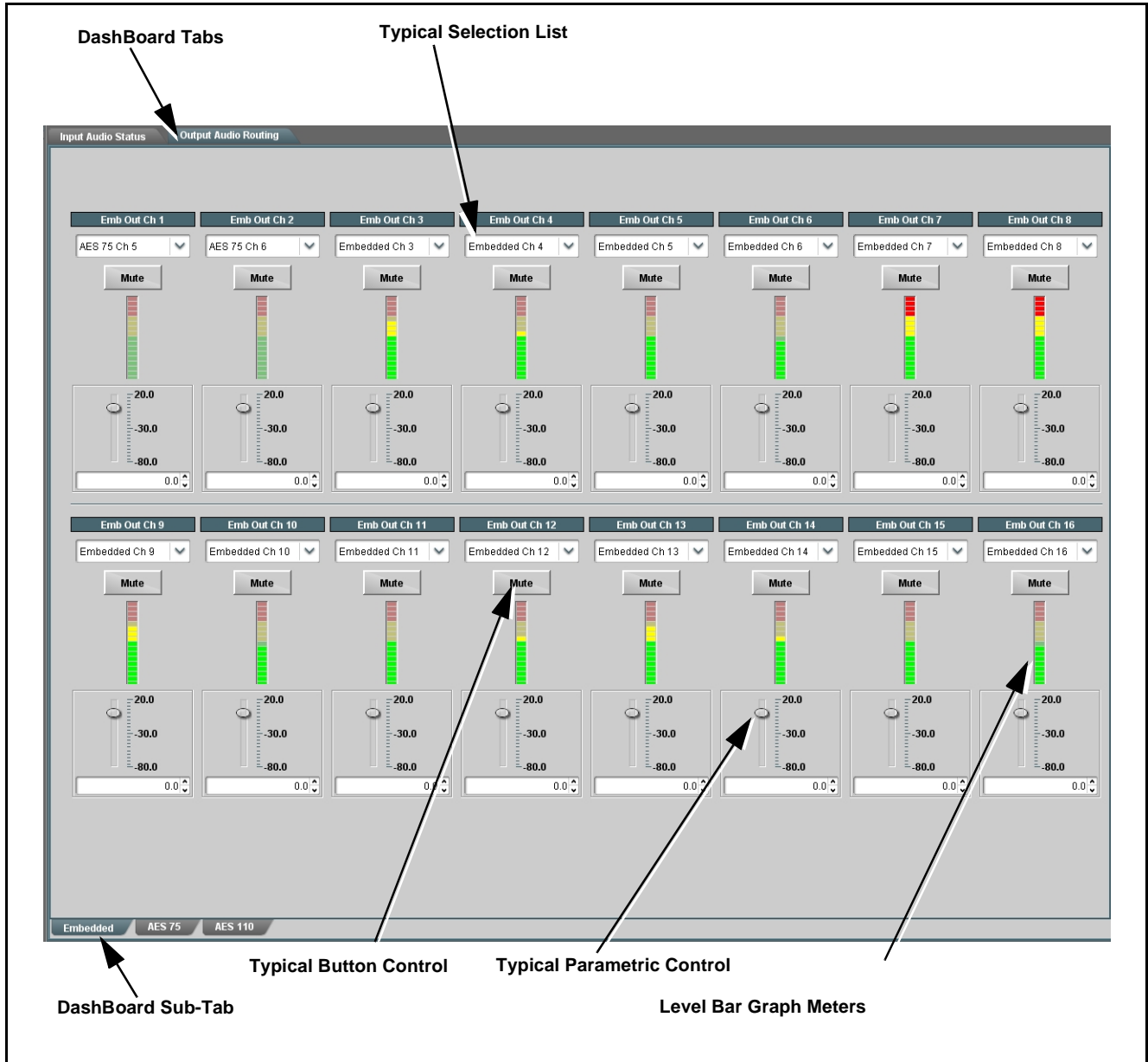

Figure 3-2 Typical DashBoard Tabs and Controls

## Accessing the 9433-EMDE Card via Remote Control

Access the 9433-EMDE card using DashBoard™ or Cobalt® Remote Control Panel as described below.

### Accessing the 9433-EMDE Card Using DashBoard™

1. On the computer connected to the frame LAN, open DashBoard™.
2. As shown below, in the left side Basic View Tree locate the Network Controller Card associated with the frame containing the 9433-EMDE card to be accessed (in this example, “MFC-8320-N SN: 00108053”).

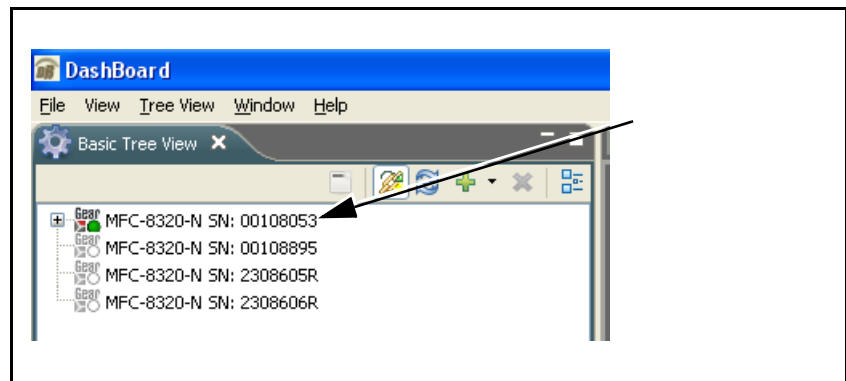

3. As shown below, expand the tree to access the cards within the frame. Click on the card to be accessed (in this example, “Slot 6: 9433-EMDE-ADDA-EOOE”).

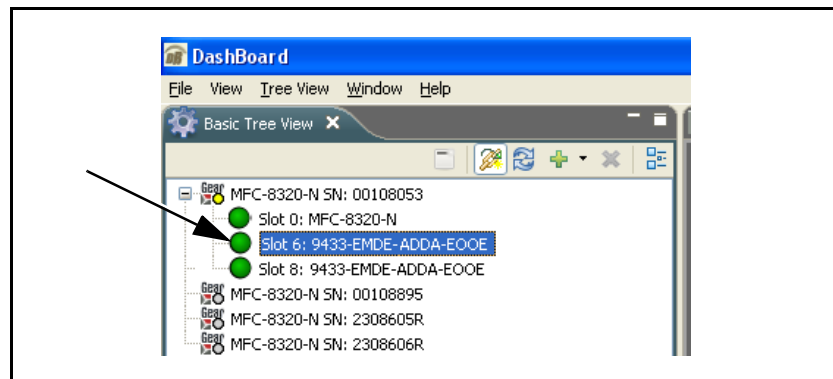

As shown on the next page, when the card is accessed in DashBoard™ its function menu screen showing tabs for each function is displayed. (The particular menu screen displayed is the previously displayed screen from the last time the card was accessed by DashBoard™).



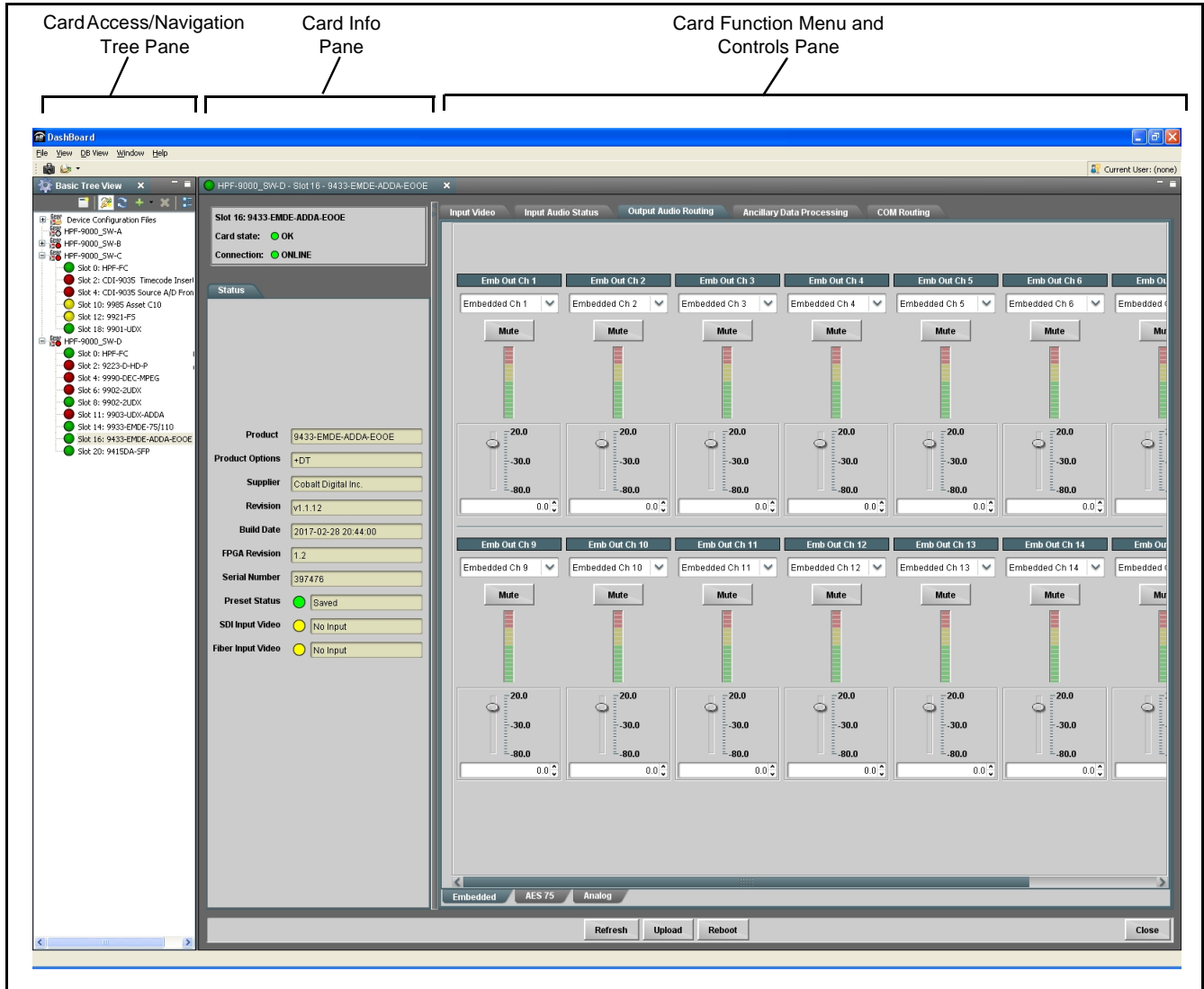

## Checking 9433-EMDE Card Information

The operating status and software version the 9433-EMDE card can be checked using DashBoard™ or the card edge control user interface. Figure 3-3 shows and describes the 9433-EMDE card information screen using DashBoard™ and accessing card information using the card edge control user interface.

**Note:** Proper operating status in DashBoard™ is denoted by green icons for the status indicators shown in Figure 3-3. Yellow or red icons respectively indicate an alert or failure condition. Refer to Troubleshooting (p. 3-16) for corrective action.

The **Tree View** shows the cards seen by DashBoard™. In this example, Network Controller Card is hosting a 9433-EMDE card in slot 12.

**Status Display**  
This display shows the status and format of the signals being received by the 9433-EMDE, as well as card status. This display also shows the the card hardware and software version info.

**Figure 3-3 9433-EMDE Card Info/Status Utility**

## 9433-EMDE Function Menu List and Descriptions

Table 3-1 individually lists and describes each 9433-EMDE function menu and its related list selections, controls, and parameters. Where helpful, examples showing usage of a function are also provided. Table 3-1 is primarily based upon using DashBoard™ to access each function and its corresponding menus and parameters.

**Note:** All numeric (scalar) parameters displayed on DashBoard™ can be changed using the slider controls,  arrows, or by numeric keypad entry in the corresponding numeric field. (When using numeric keypad entry, add a return after the entry to commit the entry.)

On DashBoard™ itself and in Table 3-1, the function menu items are organized using tabs as shown below.

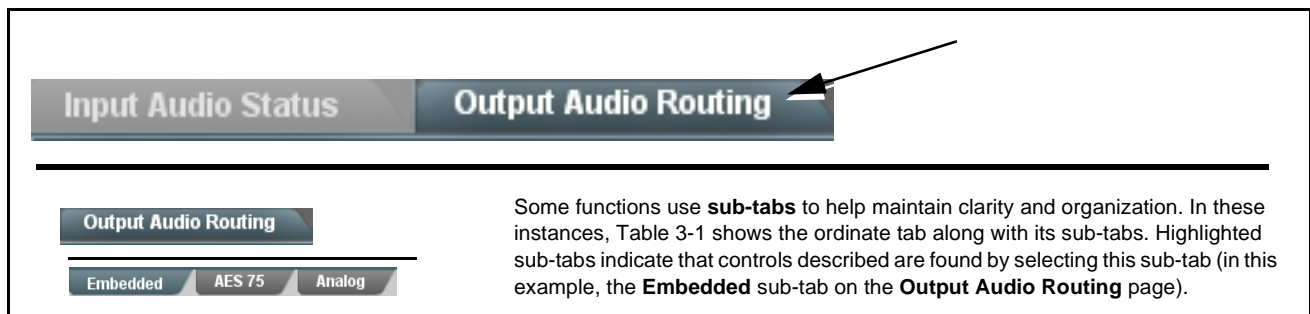

The table below provides a quick-reference to the page numbers where each function menu item can be found.

| Function Menu Item   | Page | Function Menu Item           | Page |
|----------------------|------|------------------------------|------|
| Input Video Controls | 3-8  | Ancillary Data Proc Controls | 3-13 |
| Input Audio Status   | 3-8  | COMM Ports Setup Controls    | 3-14 |
| Output Audio Routing | 3-8  |                              |      |

Table 3-1 9433-EMDE Function Menu List







|   |  |
|---|--|
|    | <p>(-OE and -EOOE only) Allows selection of card video input from SDI (coax) or Fiber inputs. Also shows status (OK and format received) or no input conditions.</p>         |
|    |  |
|    | <p>Displays signal status and payload for embedded and discrete audio received by the card. Also provides AES port user direction indication/control.</p>                    |
| <p>Individual signal status and peak level displays for embedded audio input pairs, AES, and analog input pairs as described below. AES pair status also shows sample rate.</p>   |  |
| <ul style="list-style-type: none"> <li>• <b>Absent:</b> Indicates embedded channel or AES pair does not contain recognized audio PCM data.</li> <li>• <b>Present PCM:</b> Indicates AES pair or embedded channel contains recognized audio PCM data. Running per-channel peak level is also displayed (Dolby data will show as "PCM" but will exhibit a steady per-pair 0 dBFS level).</li> </ul> <p><b>Note:</b> AES Dolby-encoded inputs are directed via a special path that automatically bypasses SRC.</p> |  |
|   | <p>Channel-pair AES port user direction indicator/controls.</p> <p><b>Note:</b> Direction indicator/controls are ganged with same controls on Output Audio Routing page.</p> |

Table 3-1 9433-EMDE Function Menu List — continued

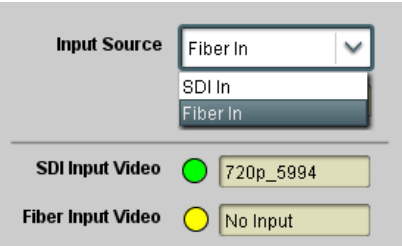
|   |  |
|---|--|
| <div style="background-color: #333; color: white; padding: 5px; font-weight: bold; font-size: 1.2em;">Output Audio Routing</div> <div style="display: flex; justify-content: space-around; margin-top: 5px;"> <span style="background-color: #ccc; padding: 2px 10px;">Embedded</span> <span style="background-color: #eee; padding: 2px 10px;">AES 75</span> <span style="background-color: #ddd; padding: 2px 10px;">Analog</span> </div> | <p>Provides source selection, gain, mute, and audio meters for embedded destination (output) channels.</p>   |
|   |  |
|   | <p>Output Audio crosspoints are available for embedded, AES 75 (AES-3id), and analog output destination channels.</p> <p>The example above shows various Source selections that direct various source choices to Emb Ch 1 thru Ch 16 destination output channels (unused channels can be set to Silence or Mute if desired).</p> <p>Each output channel provides Gain and Mute controls as well as level meters. Several internal tones generator sources can also be routed to an output channel.</p> <p><b>Note:</b> Analog audio channel can function as input or output. If intending to embed and analog audio channel, make certain channel direction DIP switches for intended channels are set as IN. See Setting I/O Switches for Analog Audio (1-8) Ports (p. 2-1) in Chapter 2, "Installation and Setup".</p> |

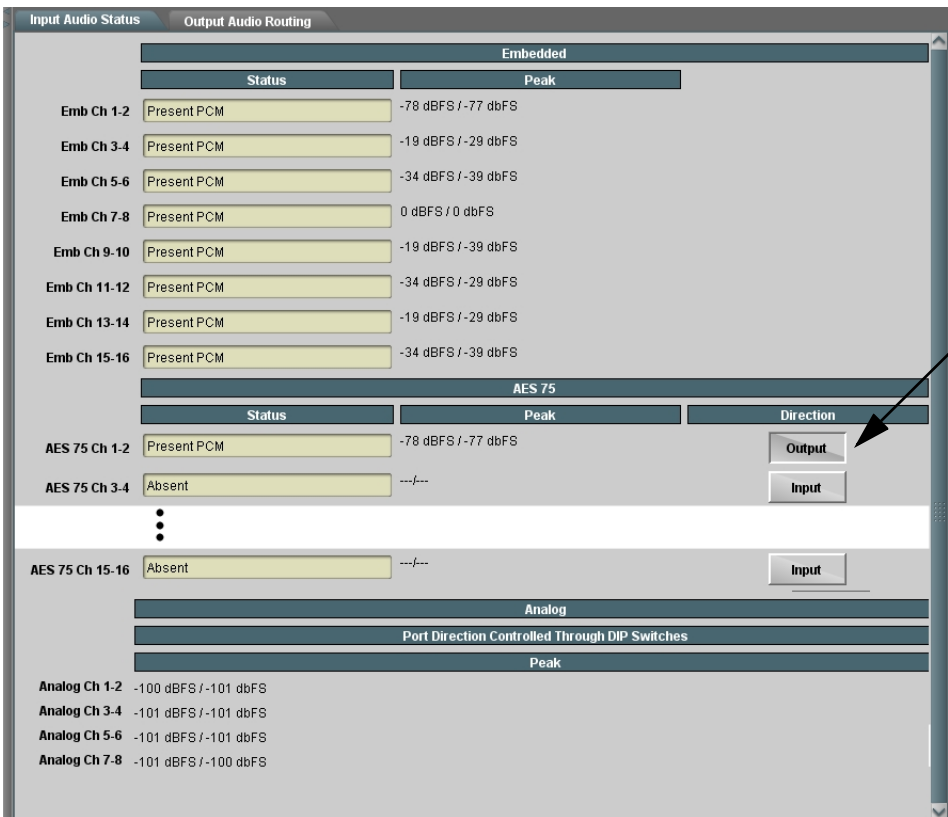
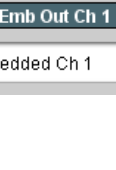
Table 3-1 9433-EMDE Function Menu List — continued

|   |  |
|---|--|
| <div style="text-align: center; background-color: #333; color: white; padding: 5px; border: 1px solid black;"> <h2 style="margin: 0;">Output Audio Routing</h2> </div> <div style="display: flex; justify-content: space-around; margin-top: 5px;"> <div style="background-color: #ccc; padding: 2px 5px; border: 1px solid #999;">Embedded</div> <div style="background-color: #ccc; padding: 2px 5px; border: 1px solid #999;">AES 75</div> <div style="background-color: #ccc; padding: 2px 5px; border: 1px solid #999;">Analog</div> </div>  | <p>(continued)</p>   |
| <p><b>Note:</b></p> <ul style="list-style-type: none"> <li>• Default factory preset routing routes as pass-thru embedded Ch 1 thru Ch 16 to Emb Ch 1 thru Emb Ch 16.</li> <li>• <b>Emb Ch 2 thru Emb Ch 16</b> have controls identical to the controls described here for <b>Emb Ch 1</b>. Therefore, only the <b>Emb Ch 1</b> controls are shown here.</li> </ul>  |  |
| <p>• <b>Embedded Audio Channel Source Select</b></p> <div style="border: 1px solid #ccc; padding: 5px; margin: 10px 0;"> <div style="background-color: #333; color: white; padding: 2px; text-align: center; font-weight: bold;">Emb Out Ch 1</div> <div style="border: 1px solid #ccc; padding: 2px; display: flex; align-items: center;"> <span style="margin-right: 5px;">Embedded Ch 1</span> <span style="font-size: 0.8em;">▼</span> </div> </div>  | <p>Using the <b>Source</b> drop-down list, selects the audio input source to be routed to the respective embedded output channel from the following choices:</p> <ul style="list-style-type: none"> <li>• Embedded input channel 1 thru 16 (<b>Embedded Ch 1 thru Embedded Ch 16</b>)</li> <li>• AES 75 (AES-3id) input channel 1 thru 16 (<b>AES 75 Ch 1 thru AES 75 Ch 16</b>)</li> <li>• Analog audio input channel 1 thru 8 (<b>Analog Ch 1 thru Analog Ch 8</b>)</li> <li>• Built-in Tone generators <b>Tone 100 Hz thru Tone 16 kHz</b> (all are -20 dBFS level; freq (Hz) in ascending order are 100, 200, 300, 400, 500, 600, 700, 800, 900, 1k, 2k, 4k, 6k, 8k, 12k, and 16k)</li> <li>• Silence</li> </ul> <p><b>Note:</b></p> <ul style="list-style-type: none"> <li>• AES pair sourcing is dependent on rear I/O module used. Current rear modules may not support full input complement.</li> <li>• AES pair selection should be boundary pairs applied to normal boundary pairs of embedded destinations.</li> <li>• For embedding from analog, make certain channel direction DIP switches for intended channels are set as IN. See Setting I/O Switches for Analog Audio (1-8) Ports (p. 2-1) in Chapter 2, "Installation and Setup".</li> </ul> |
| <p>• <b>Channel Mute/Gain Controls and Peak Level Display</b></p> <div style="border: 1px solid #ccc; padding: 10px; margin: 10px 0;"> <div style="display: flex; justify-content: space-around;"> <div style="text-align: center;"> <div style="background-color: #333; color: white; padding: 2px; font-weight: bold; width: 60px; margin: 0 auto;">Mute</div>  </div> <div style="text-align: center;"> <div style="background-color: #333; color: white; padding: 2px; font-weight: bold; width: 60px; margin: 0 auto;">Mute</div>  </div> </div> <div style="display: flex; justify-content: space-around; margin-top: 10px;"> <div style="text-align: center;">  <p style="margin: 0;">20<br/>-30<br/>-80</p> </div> <div style="text-align: center;">  <p style="margin: 0;">20<br/>-30<br/>-80</p> </div> </div> </div> | <p>Provides <b>Mute</b> channel controls, as well as peak level meter for each output channel. (Meter shows level as affected by Level control.)</p> <p><b>Gain</b> controls allow relative gain (in dB) control for the corresponding destination Embedded Audio Group channel.</p> <p>(-80 to +20 dB range in 1.0 dB steps; unity = 0 dB)</p> <p><b>Note:</b> Although the card can pass non-PCM data such as Dolby® E or AC-3, setting the gain control to any setting other than default 0 will corrupt Dolby data.</p>  |

**Table 3-1 9433-EMDE Function Menu List — continued**



|  |   |
|--|---|
|   | <p>Provides source selection, gain, mute, and audio meters for <b>AES 75</b> destination (output) channels.</p>   |
| <p><b>Note:</b> AES 75 Ch 2 thru Ch 16 have controls identical to the controls described here for <b>AES 75 Ch 1</b>. Therefore, only the AES 75 Ch 1 controls are shown here.</p> |   |
| <p>• <b>AES Pair Direction Select and Audio Channel Source Select</b></p>                         | <p><b>Input (Output)</b> buttons set an AES pair as an input or output (in this example, <b>AES 75</b> pair 1/2 set as <b>Output</b>).</p> <p><b>Note:</b> AES pair input/output selection also shown and controllable via similar controls on the Input Audio Status page.</p> <p>Using the <b>Source</b> drop-down list, selects the audio input source to be routed to the corresponding destination channel from the following choices:</p> <ul style="list-style-type: none"> <li>• Embedded input channel 1 thru 16 (<b>Embedded Ch 1</b> thru <b>Embedded Ch 16</b>)</li> <li>• AES 75 (AES-3id) input channel 1 thru 16 (<b>AES 75 Ch 1</b> thru <b>AES 75 Ch 16</b>)</li> <li>• Analog audio input channel 1 thru 8 (<b>Analog Ch 1</b> thru <b>Analog Ch 8</b>)</li> <li>• Built-in Tone generators <b>Tone 100 Hz</b> thru <b>Tone 16 kHz</b> (all are -20 dBFS level; freq (Hz) in ascending order are 100, 200, 300, 400, 500, 600, 700, 800, 900, 1k, 2k, 4k, 6k, 8k, 12k, and 16k)</li> <li>• Silence</li> </ul> <p><b>Note:</b></p> <ul style="list-style-type: none"> <li>• AES pair sourcing is dependent on rear I/O module used. Current rear modules may not support full input complement.</li> <li>• AES pair selection should be boundary pairs applied to normal boundary pairs of embedded destinations.</li> <li>• For embedding from analog, make certain channel direction DIP switches for intended channels are set as IN. See Setting I/O Switches for Analog Audio (1-8) Ports (p. 2-1) in Chapter 2, "Installation and Setup".</li> </ul> |
| <p>• <b>Channel Mute/Gain Controls and Peak Level Display</b></p>                               | <p>Provides <b>Mute</b> channel controls, as well as peak level meter for each output channel. (Meter shows level as affected by Level control.)</p> <p><b>Gain</b> controls allow relative gain (in dB) control for the corresponding destination AES channel.</p> <p>(-80 to +20 dB range in 1.0 dB steps; unity = 0 dB)</p> <p><b>Note:</b> Although the card can pass non-PCM data such as Dolby® E or AC-3, setting the gain control to any setting other than default 0 will corrupt Dolby data.</p>  |

Table 3-1 9433-EMDE Function Menu List — continued

|   |  |
|---|--|
|    | <p>Provides source selection, gain, mute, and audio meters for <b>Analog Out</b> destination (output) channels.</p>  |
| <p><b>Note:</b></p> <ul style="list-style-type: none"> <li>• <b>Analog Out Ch 2</b> thru <b>Ch 8</b> have controls identical to the controls described here for <b>Analog Out Ch 1</b>. Therefore, only the <b>AES 75 Ch 1</b> controls are shown here.</li> <li>• For <b>de-embedding to analog</b>, make certain channel direction DIP switches for intended channels are set as <b>OUT</b> (switches are default set to the <b>IN</b> position). See Setting I/O Switches for Analog Audio (1-8) Ports (p. 2-1) in Chapter 2, "Installation and Setup".</li> </ul> |  |
| <p>• <b>Analog Audio Out Channel Source Select</b></p>   | <p>Using the <b>Source</b> drop-down list, selects the audio input source to be routed to the respective analog output channel from the following choices:</p> <ul style="list-style-type: none"> <li>• Embedded input channel 1 thru 16 (<b>Embedded Ch 1</b> thru <b>Embedded Ch 16</b>)</li> <li>• AES 75 (AES-3id) input channel 1 thru 16 (<b>AES 75 Ch 1</b> thru <b>AES 75 Ch 16</b>)</li> <li>• Analog audio input channel 1 thru 8 (<b>Analog Ch 1</b> thru <b>Analog Ch 8</b>)</li> <li>• Built-in Tone generators <b>Tone 100 Hz</b> thru <b>Tone 16 kHz</b> (all are -20 dBFS level; freq (Hz) in ascending order are 100, 200, 300, 400, 500, 600, 700, 800, 900, 1k, 2k, 4k, 6k, 8k, 12k, and 16k)</li> <li>• Silence</li> </ul> |
| <p>• <b>Channel Mute/Gain Controls and Peak Level Display</b></p>    | <p>Provides <b>Mute</b> channel controls, as well as peak level meter for each output channel. (Meter shows level as affected by Level control.)</p> <p><b>Gain</b> controls allow relative gain (in dB) control for the corresponding destination Embedded Audio Group channel.</p> <p>(-80 to +20 dB range in 1.0 dB steps; unity = 0 dB)</p> <p><b>Note:</b> Maximum absolute analog output is limited to +24 dBu.</p>  |

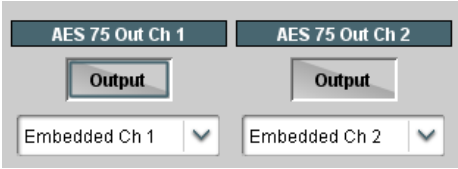
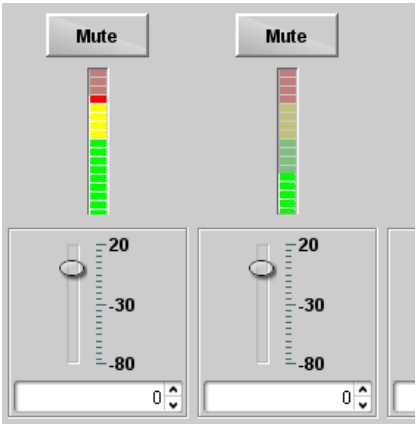

**Table 3-1 9433-EMDE Function Menu List — continued**

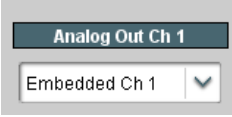
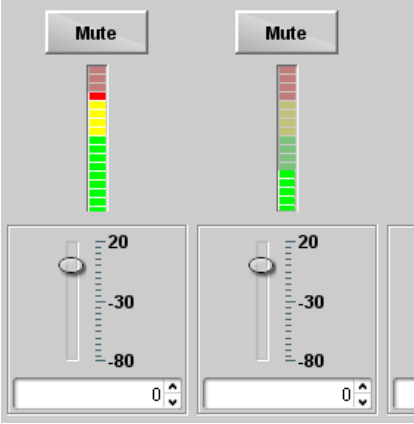
Ancillary Data Processing

Option

(Option **+DT**) Provides controls for VANC/HANC ancillary data de-embedding and embedding to and from program video stream. Data can be extracted and inserted within the card (Bridge mode), or inserted and/or extracted to and from external serial interfaces.

**COM1** and **COM2** **Insert** and **Extract** Ancillary Data Processors (ADPs) provide for insertion or extraction of serial data to and from the card program video SDI stream ancillary space. **ADP Bridge 1** thru **ADP Bridge 4** ADPs provide for moving (or removing) ANC to different locations within the stream

**DID** and **SDID** controls select the desired packet to be handled by the corresponding ANC Data Processor

**Line Number** controls select the VANC location of packet insertion/extraction. Setting the line numbers to 0 (zero) lets externally-sourced payload assert and set the line number.

**Insertion** controls allow special insertions in HANC or the C-channel, as well as removal of incoming packets

|                      | Enable                                 | DID                            | SDID                           | Field 1 Line Number            | Field 2 Line Number            | Insert in HANC                          | Insert in C                             | Remove Incoming                         |
|----------------------|--|--------------------------------|--------------------------------|--------------------------------|--------------------------------|---|---|---|
| <b>COM 1 Insert</b>  | <input type="button" value="Disable"/> | <input type="text" value="0"/> | <input type="text" value="0"/> | <input type="text" value="0"/> | <input type="text" value="0"/> | <input type="button" value="Disabled"/> | <input type="button" value="Disabled"/> | <input type="button" value="Disabled"/> |
| <b>Status</b>        | Disabled                               |                                |                                |                                |                                |   |   |   |
| <b>COM 1 Extract</b> | <input type="button" value="Disable"/> | <input type="text" value="0"/> | <input type="text" value="0"/> | <input type="text" value="0"/> | <input type="text" value="0"/> | <input type="button" value="Disabled"/> | <input type="button" value="Disabled"/> | <input type="button" value="Disabled"/> |
| <b>Status</b>        | Disabled                               |                                |                                |                                |                                |   |   |   |
| •                    |  |                                |                                |                                |                                |   |   |   |
| •                    |  |                                |                                |                                |                                |   |   |   |
| <b>ADP Bridge 4</b>  | <input type="button" value="Disable"/> | <input type="text" value="0"/> | <input type="text" value="0"/> | <input type="text" value="0"/> | <input type="text" value="0"/> | <input type="button" value="Disabled"/> | <input type="button" value="Disabled"/> | <input type="button" value="Disabled"/> |
| <b>Status</b>        | Disabled                               |                                |                                |                                |                                |   |   |   |



In this example, **COM 1 Extract** is set to extract ATC timecode at DID<sub>60h</sub> / SDID <sub>60h</sub> as shown below.

Extracting 15.0 Kbit/s, dropped 0.0 Kbit

When set to extract to **COM** interface, displays rate and dropped data (if any)

**Note:** DashBoard versions 4.1 and earlier display DID and SDID numbers in decimal; newer DashBoard versions display DID and SDID numbers in hexadecimal. Hexadecimal notation is denoted by the "0x" preceding the value.

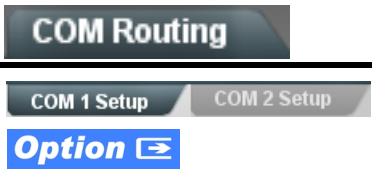
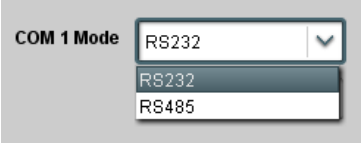
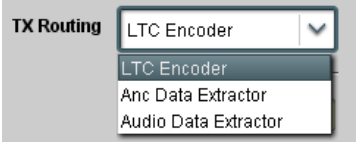
Table 3-1 9433-EMDE Function Menu List — continued

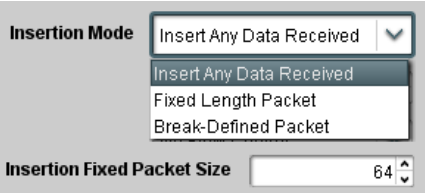
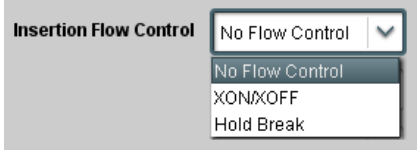
|   |  |
|---|--|
|    | <p>(Option <b>+DT</b>) Provides controls for setting up the two COMM (serial) ports for serial-to-ANC functions, and setting comm protocol for each port.</p>  |
| <p><b>Note:</b></p> <ul style="list-style-type: none"> <li>• <b>COM 1</b> and <b>COM 2</b> sub-tabs provide independent controls for COM1 and COM2. Therefore, only the <b>COM 1</b> controls are described here.</li> <li>• Controls provided here allow highly detailed setup of serial communications. Control settings must be carefully considered and set appropriately to correspond to both sending and receiving systems. Incorrectly set controls may result in loss of ANC serial comm.</li> </ul> |  |
| <p>• <b>COM Mode (Protocol)</b></p>    | <p>Selects serial comm protocol for the respective port as RS-232 or RS-485.</p> <p><b>Note:</b> Protocol choices should consider the payload to be carried. Typically, LTC is sent or received using only RS-485 serial protocol.</p>   |
| <p>• <b>COM Port Tx Routing Function</b></p>    | <p>Selects port function for the respective port as LTC Encoder input or output, or ANC Data Extractor / Audio (SMPTE 337) non-PCM input or output.</p>  |
| <p>• <b>Rx/Tx Status Display</b></p>   | <p>Shows either no data received/sent, or where transfer is present shows data rate (in kbit/sec).</p>   |
| <p>• <b>Insertion Mode Control</b></p>   | <p>Where data is being inserted (received), sets the insertion as follows:</p> <ul style="list-style-type: none"> <li>• <b>Insert Any Data Received:</b> Insert all received data with no regard for packet size.</li> <li>• <b>Fixed Length Packet:</b> Sets receive to wait and accumulate <i>n</i>-number of packet bytes (as set using <b>Insertion Fixed Packet Size</b> control) before inserting data.</li> <li>• <b>Break-Defined Packet:</b> Card receiver looks for character-defined break from source being received to define breaks.</li> </ul>  |
| <p>• <b>Insertion Flow Control</b></p>   | <p>Allows communication between card receive and sending source to regulate data receive as follows:</p> <ul style="list-style-type: none"> <li>• <b>No Flow Control:</b> Data is received without buffering or checking to see if data is being received faster than it can be inserted.</li> <li>• <b>XON / XOFF:</b> The card UART Tx will tell the sending source whether it can or cannot accept data at current bit rate.</li> <li>• <b>Hold Break:</b> Card, if close to not being able to accept new data, tells the sending source to hold, and releases this hold when the card is again able to accept new data.</li> </ul> |

**Table 3-1 9433-EMDE Function Menu List — continued**

| <div style="background-color: #333; color: white; padding: 5px; text-align: center; font-weight: bold;">COM Routing</div> <div style="display: flex; justify-content: space-around; margin-top: 5px;"> <span style="background-color: #ccc; padding: 2px 5px;">COM 1 Setup</span> <span style="background-color: #ccc; padding: 2px 5px;">COM 2 Setup</span> </div>  | (continued)   |
|--|---|
| <ul style="list-style-type: none"> <li>• <b>Insertion Sync Byte Control</b></li> </ul> <div style="border: 1px solid #ccc; padding: 5px; margin-top: 10px;"> <p>Insertion Sync Byte <span style="float: right;">▼</span></p> <div style="border: 1px solid #ccc; padding: 2px; margin-top: 2px;">             Disabled           </div> <div style="border: 1px solid #ccc; padding: 2px; margin-top: 2px;">             Disabled           </div> <div style="border: 1px solid #ccc; padding: 2px; margin-top: 2px;">             Field Number at SOF           </div> <div style="border: 1px solid #ccc; padding: 2px; margin-top: 2px;">             Ack on Insertion           </div> </div>   | <p>Allows use of a sync byte from card receiver back to sending source to synchronize communication between card receive and sending source as follows:</p> <ul style="list-style-type: none"> <li>• <b>Disabled:</b> No special synchronization.</li> <li>• <b>Field Number at SOF:</b> The card sends a single byte telling sending source when start of field 1 or field 2 is occurring.</li> <li>• <b>Ack on Insertion:</b> Card sends a single byte back to sending source when data has been inserted.</li> </ul>   |
| <ul style="list-style-type: none"> <li>• <b>Extraction Mode Control</b></li> </ul> <div style="border: 1px solid #ccc; padding: 5px; margin-top: 10px;"> <p>Extraction Mode <span style="float: right;">▼</span></p> <div style="border: 1px solid #ccc; padding: 2px; margin-top: 2px;">             Payload Only           </div> <div style="border: 1px solid #ccc; padding: 2px; margin-top: 2px;">             Payload Only           </div> <div style="border: 1px solid #ccc; padding: 2px; margin-top: 2px;">             Full Anc Data Packet           </div> </div>   | <p>Where data is being extracted from input video, sets the data to be sent as follows:</p> <ul style="list-style-type: none"> <li>• <b>Payload Only:</b> Sends payload only (for example, for closed captioning this would be only the ASCII character string representing the CC content).</li> <li>• <b>Full Anc Data Packet:</b> Sends the entire packet, including payload, DID, SDID, and any handling or marking characters.</li> </ul>  |
| <ul style="list-style-type: none"> <li>• <b>Extraction Flow Control</b></li> </ul> <div style="border: 1px solid #ccc; padding: 5px; margin-top: 10px;"> <p>Extraction Flow Control <span style="float: right;">▼</span></p> <div style="border: 1px solid #ccc; padding: 2px; margin-top: 2px;">             No Flow Control           </div> <div style="border: 1px solid #ccc; padding: 2px; margin-top: 2px;">             No Flow Control           </div> <div style="border: 1px solid #ccc; padding: 2px; margin-top: 2px;">             XON/XOFF           </div> <div style="border: 1px solid #ccc; padding: 2px; margin-top: 2px;">             Hold Break           </div> </div>  | <p>Allows communication between card transmit and receiving destinations to regulate data receive as follows:</p> <ul style="list-style-type: none"> <li>• <b>No Flow Control:</b> Data is transmitted without buffering or checking to see if data is being transmitted faster than it can be received.</li> <li>• <b>XON / XOFF:</b> The card UART Rx will acknowledge from the receiving system whether it can or cannot accept data at current bit rate.</li> <li>• <b>Hold Break:</b> Card, if receiving notification from the receiving system that it is close to not being able to accept new data, tells the card to hold. Card releases this hold when the receiving system removes the break command, indicating destination is now ready again to accept new data.</li> </ul> |
| <ul style="list-style-type: none"> <li>• <b>Bit Rate/ Parity Gen Control</b></li> </ul> <div style="border: 1px solid #ccc; padding: 5px; margin-top: 10px;"> <p>Bit Rate <span style="float: right;">▼</span></p> <div style="border: 1px solid #ccc; padding: 2px; margin-top: 2px;">             115200           </div> <p>Parity <span style="float: right;">▼</span></p> <div style="border: 1px solid #ccc; padding: 2px; margin-top: 2px;">             Disabled           </div> <div style="border: 1px solid #ccc; padding: 2px; margin-top: 2px;">             Disabled           </div> <div style="border: 1px solid #ccc; padding: 2px; margin-top: 2px;">             Odd           </div> <div style="border: 1px solid #ccc; padding: 2px; margin-top: 2px;">             Even           </div> </div> | <p>For both Rx and Tx, sets UART for bit rate and parity as follows:</p> <ul style="list-style-type: none"> <li>• <b>Bit Rate:</b> Sets Tx/Rx bit rate from 1 of 5 speeds ranging from 9600 to 230400 Baud.</li> <li>• <b>Parity:</b> Sets card Rx to expect odd or even parity from incoming data, and sets card Tx to generate a parity bit to satisfy selected parity. Where parity is set, incoming data not conforming to parity selection is rejected.</li> </ul>   |

## Troubleshooting

This section provides general troubleshooting information and specific symptom/corrective action for the 9433-EMDE card and its remote control interface. The 9433-EMDE card requires no periodic maintenance in its normal operation; if any error indication (as described in this section) occurs, use this section to correct the condition.

### Error and Failure Indicator Overview

The 9433-EMDE card itself and its remote control systems all (to varying degrees) provide error and failure indications. Depending on how the 9433-EMDE card is being used (i.e., standalone or network controlled through DashBoard™ or a Remote Control Panel), check all available indications in the event of an error or failure condition. The various 9433-EMDE card and remote control error and failure indicators are individually described below.

**Note:** The descriptions below provide general information for the various status and error indicators. For specific failures, also use the appropriate subsection listed below.

- Basic Troubleshooting Checks (p. 3-19)
- 9433-EMDE Processing Error Troubleshooting (p. 3-19)
- Troubleshooting Network/Remote Control Errors (p. 3-20)

### 9433-EMDE Card Edge Status/Error Indicators and Display

Figure 3-4 shows and describes the 9433-EMDE card edge status indicators and display. These indicators and the display show status and error conditions relating to the card itself and remote (network) communications (where applicable). Because these indicators are part of the card itself and require no external interface, the indicators are particularly useful in the event of communications problems with external devices such as network remote control devices.

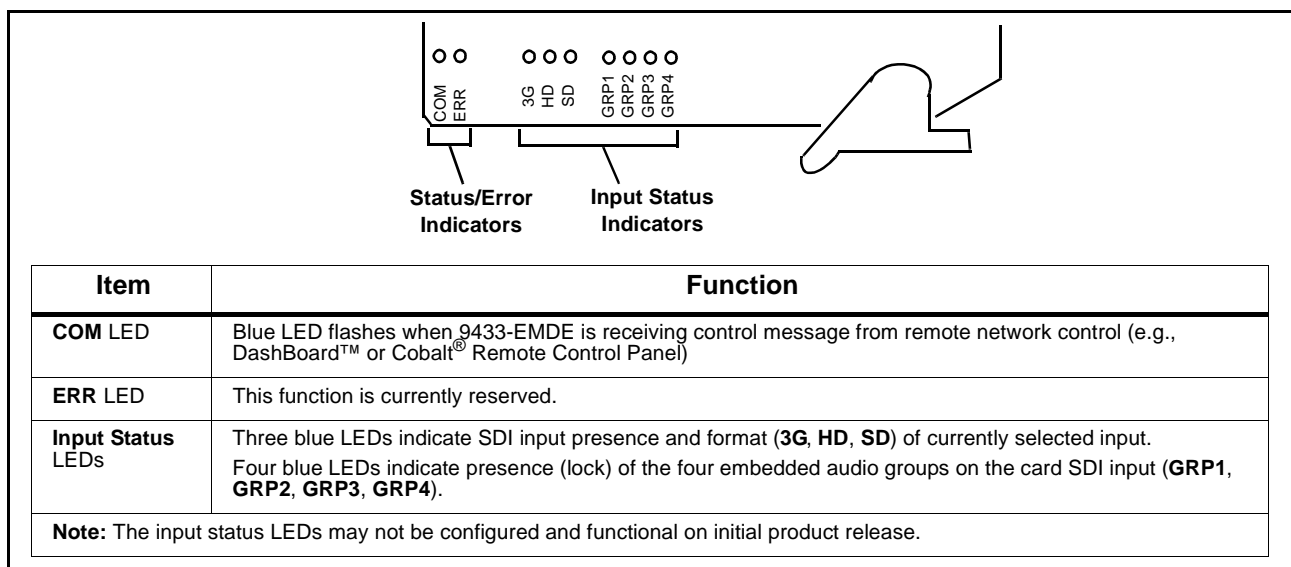

**Figure 3-4 9433-EMDE Card Edge Status Indicators and Display**

### DashBoard™ Status/Error Indicators and Displays

Figure 3-5 shows and describes the DashBoard™ status indicators and displays. These indicator icons and displays show status and error conditions relating to the 9433-EMDE card itself and remote (network) communications.



| Indicator Icon or Display   | Error Description   |
|---|---|
|    | <p>Red indicator icon in Card Access/Navigation Tree pane shows card with Error condition (in this example, the Card Access/Navigation Tree pane shows a general error issued by the 9433-EMDE card in slot 6).</p> <p>Specific errors are displayed in the Card Info pane (in this example “No connection to device” indicating 9433-EMDE card is not connecting to frame/LAN). If the 9433-EMDE card is not connecting to the frame or LAN, all controls are grayed-out (as shown in the example here).</p> |
|    | <p>Gray indicator icon in Card Access/Navigation Tree pane shows card(s) are not being seen by DashBoard™ due to lack of connection to frame LAN (in this example, both a 9433-EMDE card in slot 6 and the MFC-8320-N Network Controller Card for its frame in slot 0 are not being seen).</p>  |
|   | <p>Yellow indicator icon in Card Access/Navigation Tree pane shows card with Alert condition (in this example, the Card Access/Navigation Tree pane shows a general alert issued by the MFC-8320-N Network Controller Card).</p> <p>Clicking the card slot position in the Card Access/Navigation Tree (in this example Network Controller Card “Slot 0: MFC-8320-N”) opens the Card Info pane for the selected card. In this example, a “Fan Door Open” specific error is displayed.</p>                     |
|  | <p>Yellow indicator icon in 9433-EMDE Card Info pane shows error alert, along with cause for alert (in this example, the 9433-EMDE is not receiving a video input for the selected input source).</p>   |

Figure 3-5 DashBoard™ Status Indicator Icons and Displays

Access Card Info panes for specific cards by clicking the card slot position in the Card Access/Navigation Tree pane (as shown in the example in Figure 3-6).

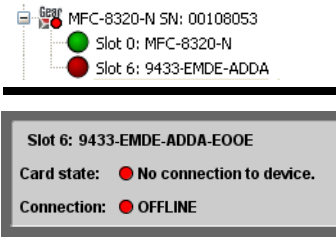
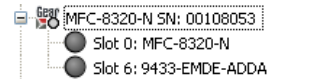
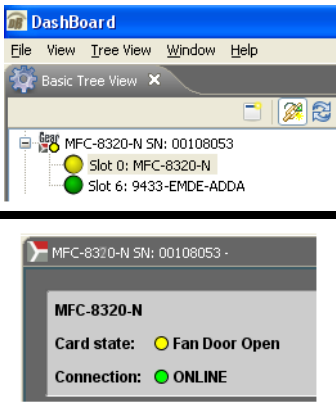
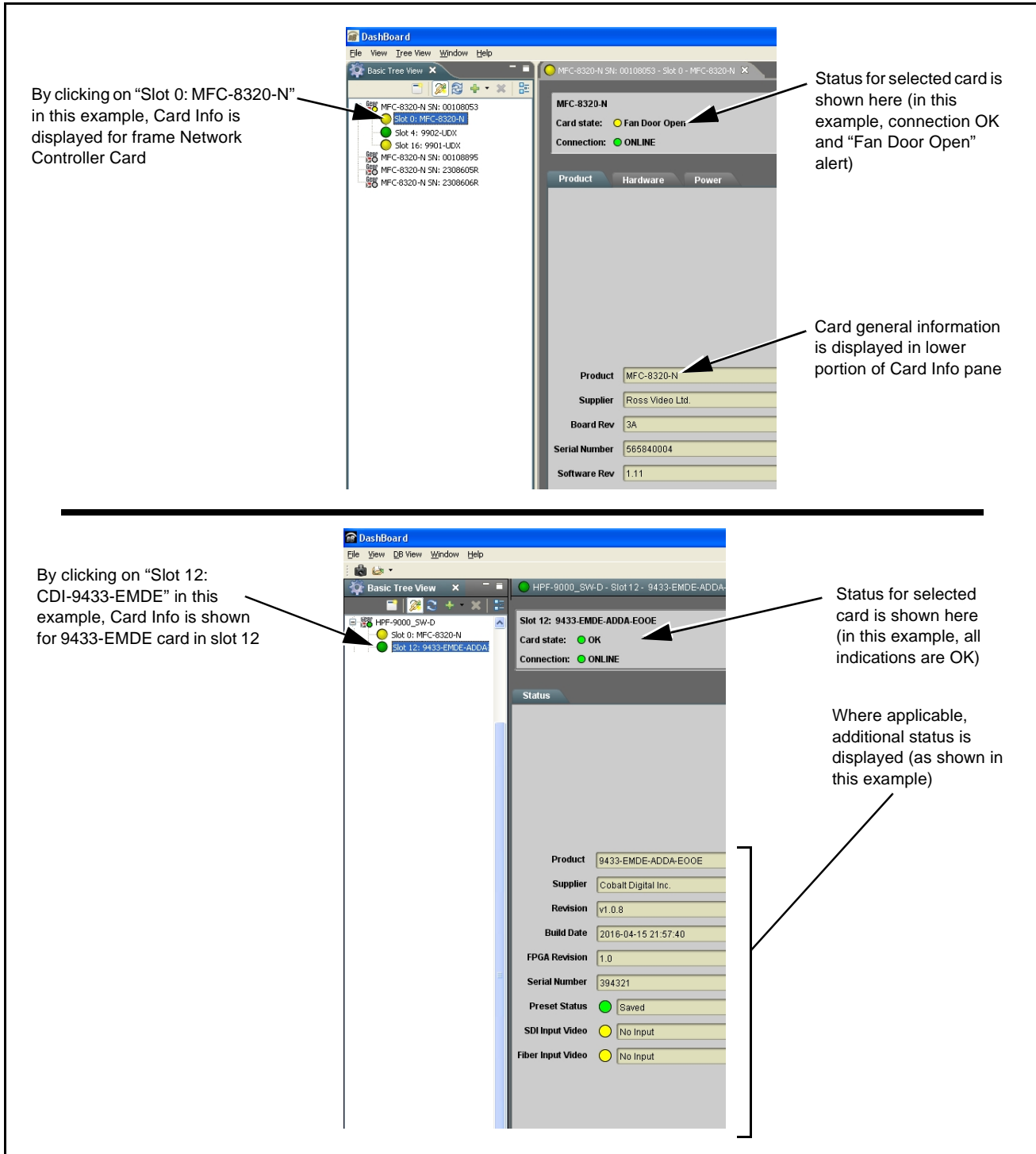

Figure 3-6 Selecting Specific Cards for Card Info Status Display

## Basic Troubleshooting Checks

Failures of a general nature (affecting many cards and/or functions simultaneously), or gross inoperability errors are best addressed first by performing basic checks before proceeding further. Table 3-2 provides basic system checks that typically locate the source of most general problems. If required and applicable, perform further troubleshooting in accordance with the other troubleshooting tables in this section.

**Table 3-2 Basic Troubleshooting Checks**

| Item   | Checks  |
|--|---|
| <b>Verify power presence and characteristics</b>               | On both the frame Network Controller Card and the 9433-EMDE, in all cases when power is being properly supplied there is always at least one indicator illuminated. Any card showing no illuminated indicators should be cause for concern.   |
| <b>Check Cable connection secureness and connecting points</b> | Make certain all cable connections are fully secure (including coaxial cable attachment to cable ferrules on BNC connectors). Also, make certain all connecting points are as intended. Make certain the selected connecting points correlate to the intended card inputs and/or outputs. Cabling mistakes are especially easy to make when working with large I/O modules. |
| <b>Card seating within slots</b>                               | Make certain all cards are properly seated within its frame slot. (It is best to assure proper seating by ejecting the card and reseating it again.)  |
| <b>Check status indicators and displays</b>                    | On both DashBoard™ and the 9433-EMDE card edge indicators, red indications signify an error condition. If a status indicator signifies an error, proceed to the following tables in this section for further action.  |
| <b>Troubleshoot by substitution</b>                            | All cards within the frame can be hot-swapped, replacing a suspect card or module with a known-good item.   |

## 9433-EMDE Processing Error Troubleshooting

Table 3-3 provides 9433-EMDE processing troubleshooting information. If the 9433-EMDE card exhibits any of the symptoms listed in Table 3-3, follow the troubleshooting instructions provided.

In the majority of cases, most errors are caused by simple errors where the 9433-EMDE is not appropriately set for the type of signal being received by the card.

- Note:**
- The error indications shown below are typical for the corresponding error conditions listed. Other error indications not specified here may also be displayed on DashBoard™ and/or the 9433-EMDE card edge status indicators.
  - Where errors are displayed on both the 9433-EMDE card and network remote controls, the respective indicators and displays are individually described in this section.

**Table 3-3 Troubleshooting Processing Errors by Symptom**

| Symptom   | Error/Condition   | Corrective Action   |
|---|---|---|
| <ul style="list-style-type: none"> <li>• <b>DashBoard™</b> shows <b>Unlocked</b> message in 9433-EMDE Status pane</li> </ul>  <ul style="list-style-type: none"> <li>• Card edge <b>Input</b> LED corresponding to input is not illuminated</li> </ul> | No video input present  | Make certain intended video source is connected to appropriate 9433-EMDE card video input. Make certain BNC cable connections between frame Rear I/O Module for the card and signal source are OK.                          |
| Audio not processed or passed through card  | <ul style="list-style-type: none"> <li>• AES port not set as input or output as intended</li> </ul>       | On <b>Input Audio Status</b> or <b>Output Audio Routing</b> tab, make certain port direction setting matches desired direction.   |
|   | <ul style="list-style-type: none"> <li>• Analog audio port switches not set for intended usage</li> </ul> | Analog audio Ch 1 thru Ch 8 use DIP switches on the card PCB to set intended direction (IN or OUT). See Setting I/O Switches for Analog Audio (1-8) Ports (p. 2-1) in Chapter 2, “Installation and Setup” for instructions. |
| Dolby audio corrupted or unrecognized by downstream device  | Audio Output Routing Gain control(s) for port set to setting other than unity gain (0.0 dB)               | Although the card can pass non-PCM data such as Dolby® E or AC-3, setting the gain control to any setting other than default 0 will corrupt Dolby data.   |

## Troubleshooting Network/Remote Control Errors

Refer to Cobalt® reference guide “Remote Control User Guide” (PN 9000RCS-RM) for network/remote control troubleshooting information.

## In Case of Problems

Should any problem arise with this product that was not solved by the information in this section, please contact the Cobalt Digital Inc. Technical Support Department.

If required, a Return Material Authorization number (RMA) will be issued to you, as well as specific shipping instructions. If required, a temporary replacement item will be made available at a nominal charge. Any shipping costs incurred are the customer’s responsibility. All products shipped to you from Cobalt Digital Inc. will be shipped collect.

The Cobalt Digital Inc. Technical Support Department will continue to provide advice on any product manufactured by Cobalt Digital Inc., beyond the warranty period without charge, for the life of the product.

See Contact Cobalt Digital Inc. (p. 1-15) in Chapter 1, “Introduction“ for contact information.







**Cobalt Digital Inc.**

2506 Galen Drive  
Champaign, IL 61821  
Voice 217.344.1243 • Fax 217.344.1245  
[www.cobaltdigital.com](http://www.cobaltdigital.com)