

DRAWMER



MX60

FRONT END ONE OPERATORS MANUAL

CONTENTS

SAFETY CONSIDERATIONS	page 2
INSTALLATION	page 3
INTRODUCTION	page 4
• Audio Connections	page 6
• Power Connection	page 8
CONTROL DESCRIPTIONS	page 9
OPERATION	page 13
IF A FAULT DEVELOPS	page 16
CONTACTING DRAWMER	page 16
TECHNICAL SPECIFICATION	page 17
BLOCK DIAGRAM	page 18
SESSION RECALL	page 19

COPYRIGHT

This manual is copyrighted © 2011 by Drawmer Electronics, Ltd. With all rights reserved. Under copyright laws, this manual may not be duplicated in whole or in part without the written consent of Drawmer.

ONE YEAR LIMITED WARRANTY

Drawmer Electronics Ltd., warrants the Drawmer MX60 Front End One to conform substantially to the specifications of this manual for a period of one year from the original date of purchase when used in accordance with the specifications detailed in this manual. In the case of a valid warranty claim, your sole and exclusive remedy and Drawmer's entire liability under any theory of liability will be to, at Drawmer's discretion, repair or replace the product without charge, or, if not possible, to refund the purchase price to you. This warranty is not transferable. It applies only to the original purchaser of the product.

For warranty service please call your local Drawmer dealer. Alternatively call Drawmer Electronics Ltd. at +44 (0)1709 527574. Then ship the defective product, with transportation and insurance charges pre-paid, to Drawmer Electronics Ltd., Coleman Street, Parkgate, Rotherham, S62 6EL UK. Write the RA number in large letters in a prominent position on the shipping box. Enclose your name, address, telephone number, copy of the original sales invoice and a detailed description of the problem. Drawmer will not accept responsibility for loss or damage during transit.

This warranty is void if the product has been damaged by misuse, modification or unauthorised repair.

THIS WARRANTY IS IN LIEU OF ALL WARRANTIES, WHETHER ORAL OR WRITTEN, EXPRESSED, IMPLIED OR STATUTORY. DRAWMER MAKES NO OTHER WARRANTY EITHER EXPRESS OR IMPLIED, INCLUDING, WITHOUT LIMITATION, ANY IMPLIED WARRANTIES OF MERCHANTABILITY, FITNESS FOR A PARTICULAR PURPOSE, OR NON-INFRINGEMENT. PURCHASER'S SOLE AND EXCLUSIVE REMEDY UNDER THIS WARRANTY SHALL BE REPAIR OR REPLACEMENT AS SPECIFIED HEREIN.

IN NO EVENT WILL DRAWMER ELECTRONICS LTD. BE LIABLE FOR ANY DIRECT, INDIRECT, SPECIAL, INCIDENTAL OR CONSEQUENTIAL DAMAGES RESULTING FROM ANY DEFECT IN THE PRODUCT, INCLUDING LOST PROFITS, DAMAGE TO PROPERTY, AND, TO THE EXTENT PERMITTED BY LAW, DAMAGE FOR PERSONAL INJURY, EVEN IF DRAWMER HAS BEEN ADVISED OF THE POSSIBILITY OF SUCH DAMAGES.

Some states and specific countries do not allow the exclusion of implied warranties or limitations on how long an implied warranty may last, so the above limitations may not apply to you. This warranty gives you specific legal rights. You may have additional rights that vary from state to state, and country to country.

In the interests of product development, Drawmer reserve the right to modify or improve specifications of this product at any time, without prior notice.

DRAWMER MX60

Front End One



SAFETY CONSIDERATIONS



CAUTION - MAINS FUSE

TO REDUCE THE RISK OF FIRE REPLACE THE MAINS FUSE ONLY WITH THE SAME TYPE, WHICH MUST BE A CLASS 3, 230 VOLT, TIME DELAY TYPE, RATED AT 63mA WHERE THE MAINS INPUT VOLTAGE SWITCH IS SET TO 230 VOLTS AC. AND 125mA WHERE THE MAINS INPUT VOLTAGE IS 115 VOLTS AC.

ALL FUSES MUST COMPLY WITH IEC 127-2.
THE FUSE BODY SIZE IS 20mm x 5mm.

CAUTION - MAINS CABLE

DO NOT ATTEMPT TO CHANGE OR TAMPER WITH THE SUPPLIED MAINS CABLE.

CAUTION - SERVICING

DO NOT PERFORM ANY SERVICING. REFER ALL SERVICING TO QUALIFIED SERVICE PERSONNEL.

WARNING

TO REDUCE THE RISK OF FIRE OR ELECTRIC SHOCK DO NOT EXPOSE THIS EQUIPMENT TO RAIN OR MOISTURE.



INSTALLATION

The MX60 is designed for standard 19" rack mounting and occupies 1U of rack space. Avoid mounting the unit directly above power amplifiers or power supplies that radiate significant amounts of heat. **Always** connect the mains earth to the unit. Use fibre or plastic washers to prevent the front panel becoming marked by the mounting bolts.

INTRODUCTION

The MX60 is a high quality mic/line preamplifier with integral gate, de-esser, compressor, parametric equaliser and peak limiter. It also features Drawmer's proprietary multi-band tube-sound circuitry which provides independently adjustable saturation in three separate audio bands. This may be used either to create subtle warming or high frequency enhancing effects, or it may be applied more strongly to create very obvious effects. The MX60 is suitable for both live sound and studio applications. All buttons other than the de-esser Male/Female switch have status LEDs.

The MX60 may be used in balanced systems at +4dBu operating levels using the XLR or balanced TRS jack output connectors, or unbalanced at -10dBu using the separate TS jack output. Inputs are provided for balanced low impedance microphones with switchable 48V phantom power, balanced line at +4dBu on a TRS jack or unbalanced line at -10dBu via an unbalanced TS jack. A further Instrument input is provided on the front panel for use with sources that require a high impedance input stage, for example, electric guitars and basses. Included only in this section are 20dB and Bright switches. An insert point is provided directly after the preamp section, followed by phase reverse and high pass filter switches. A four-section LED meter registers the output level of the preamp stage.

The human voice is structurally complex and has a wide dynamic range, which is why the MX60 includes a high performance dynamics section comprising a gate, a de-esser and a compressor section. The gate is designed to be easy to set up and silences signals that drop below a minimum level set by the user. Fast and slow release options are included to accommodate all types of material.

The high quality VCA compressor is based on that of the MX30 and reduces the dynamic range of the signal by reducing the gain of loud signals that exceed a threshold set by the user. Both the attack and release times are programme adaptive leaving the user with only ratio, threshold and make-up gain to adjust. Though simple to set up, the gate section is based on that of the Drawmer DL241/MX30 and, like the compressor, it is programme adaptive so that the time constants are automatically optimised for the material being processed.

Problems can arise when sibilant (S and T) sounds are over-emphasised by a particular singer as they only occur on specific sounds, making it impossible to address them effectively by using a fixed equaliser setting. In some situations, the sibilant sounds may overload some part of the audio chain resulting in an unpleasant distortion. The solution is to use a de-esser, but the Drawmer approach to de-essing is rather more sophisticated than most and the de-esser in the MX60 works on the same principle as that in the MX50 dedicated de-esser where the de-esser automatically and continuously readjusts its own threshold level.

A conventional de-esser can be set up by introducing equalisation into the side-chain of a compressor and adjusting the equaliser so that the signal is boosted in the area of the spectrum where sibilant sounds occur, forcing the compressor to react more to high frequency sibilant sounds than to general speech frequencies. This is less than ideal because the whole signal drops in level whenever a sibilant sound occurs, which can result in the vocal taking on an unnatural lisping characteristic. The MX60 de-esser is almost completely automatic requiring the user only to select a male or female setting and to adjust the amount of de-essing taking place. Only that part of the spectrum containing sibilant sounds is subjected to gain reduction so that the lisping effect of simpler de-essers is avoided.

Equalisation is provided after compression so that tonal changes can be made without affecting the compressor action. The MX60 has a powerful three-band equaliser that features shelving high and low sections in conjunction with a fully parametric mid-range section.

The Tubesound section, is based around low noise solid-state circuitry designed to emulate the overdrive characteristics of vacuum tubes. Here the signal is split into three frequency bands and each band is provided with a variable drive control. Increasing the drive level increases both the level and harmonic content of the relevant band, and at low drive settings, it's possible to emulate the characteristics of a tube microphone, to add HF enhancement or to warm up the lower octaves. Higher settings may be used to create more obvious distortion effects on voices or instruments.

At the end of the signal path is a fixed threshold limiter which comes prior to the output level control (Master Fader). The limiter has a fixed preset threshold of +20dBu and the Master fader scales the signal level down to the required level. A hard limit LED indicates the onset of limiting. The soft limit LED indicates a level 6dB below the main limiter, where progressive rounding of signal peaks occurs prior to the onset of hard limiting.

AUDIO CONNECTIONS

Input and Output connections are provided for use at +4dBu via balanced XLRs for Mic. Line is either at +4dBu via a Balanced jack or at -10dBu via unbalanced jacks. It is permissible to use both +4dBu and -10dBu outputs simultaneously. If unbalanced operation at +4dBu is required, simply connect the unused terminal to Ground inside the balanced jack socket. This applies to both inputs and outputs. The wiring convention for XLR being: pin 1 Ground, pin 2 Hot and pin 3 Cold. For use with unbalanced systems, the Cold pin 3 must be grounded at both input and output XLRs. For jack operation refer to diagram.

Interference: If the unit is to be used where it maybe exposed to high levels of disturbance such as found close to a TV or radio transmitter, we suggest that the unit be operated using the XLR connectors. The screens of the signal cables should be connected to the chassis connection on the XLR connector as opposed to connecting to pin1. The MX60 fully conforms to the EMC standards.

Ground Loops: If ground loop problems are encountered, **never** disconnect the mains earth, but instead, try disconnecting the signal screen on one end of each of the cables connecting the outputs of the MX60 to the patchbay. If such measures are necessary, balanced operation is recommended.

Level Conversion: It is possible to apply signals to both the +4dBu and -10dBu Line inputs simultaneously. Also both the -10dB and +4dB output sockets can be used simultaneously. This allows level conversion to occur.

One useful example of this connection option would be if the unit was used to process a keyboard - commonly these have an output level of -10dB, and are terminated with jack sockets. It is feasible using the MX60s dual output capability to use the -10dB jack input to feed from the keyboard and the -10dB output onwards to the amplifier, and the +4dB balanced XLR connector for a direct feed to the mixing console. This removes the need for any DI box or cable splitter. In this example, ground loop considerations may be required.

AUDIO CONNECTION DIAGRAM

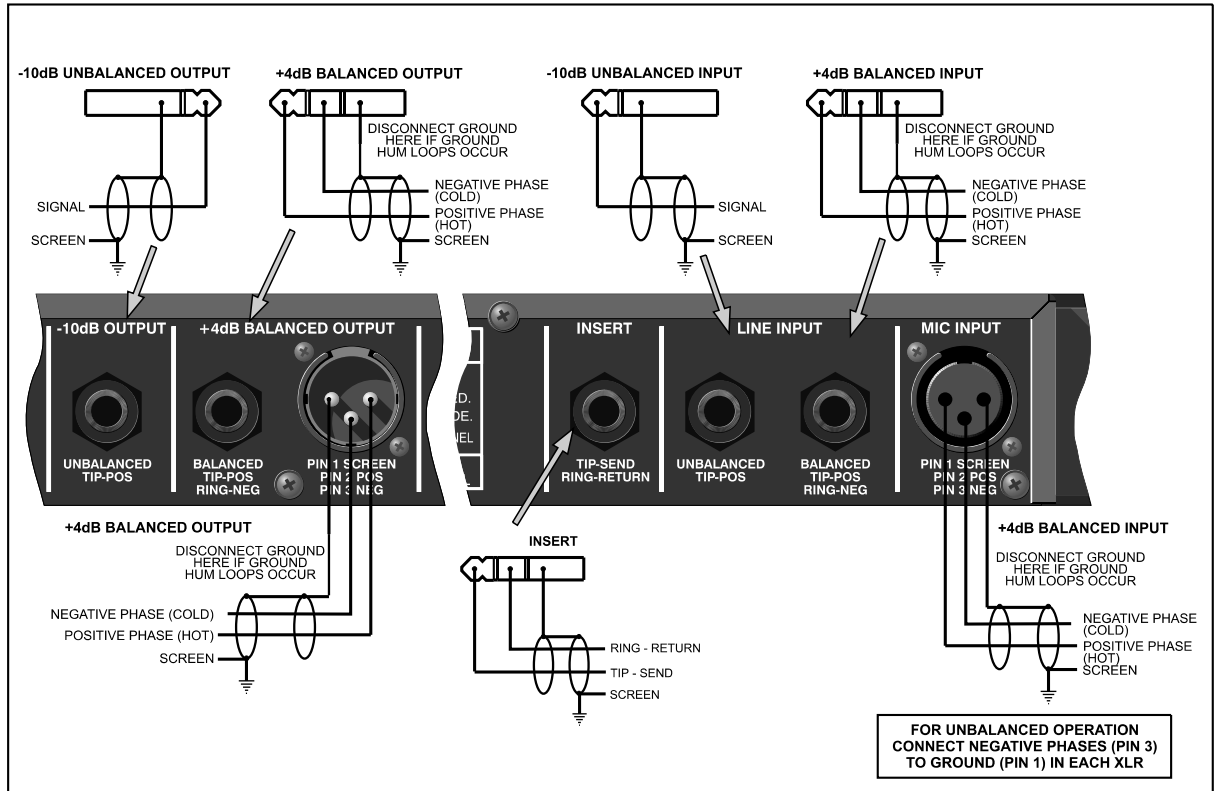

POWER CONNECTION

If, for some reason, the unit is to be operated at a mains input voltage which is different to that as supplied, the following procedure must be carried out by a **qualified technical engineer**.

- 1: Disconnect the unit from the mains.
- 2: Using a number 1 size pozidrive screwdriver, remove the seven self-tapping screws that retain the top cover.

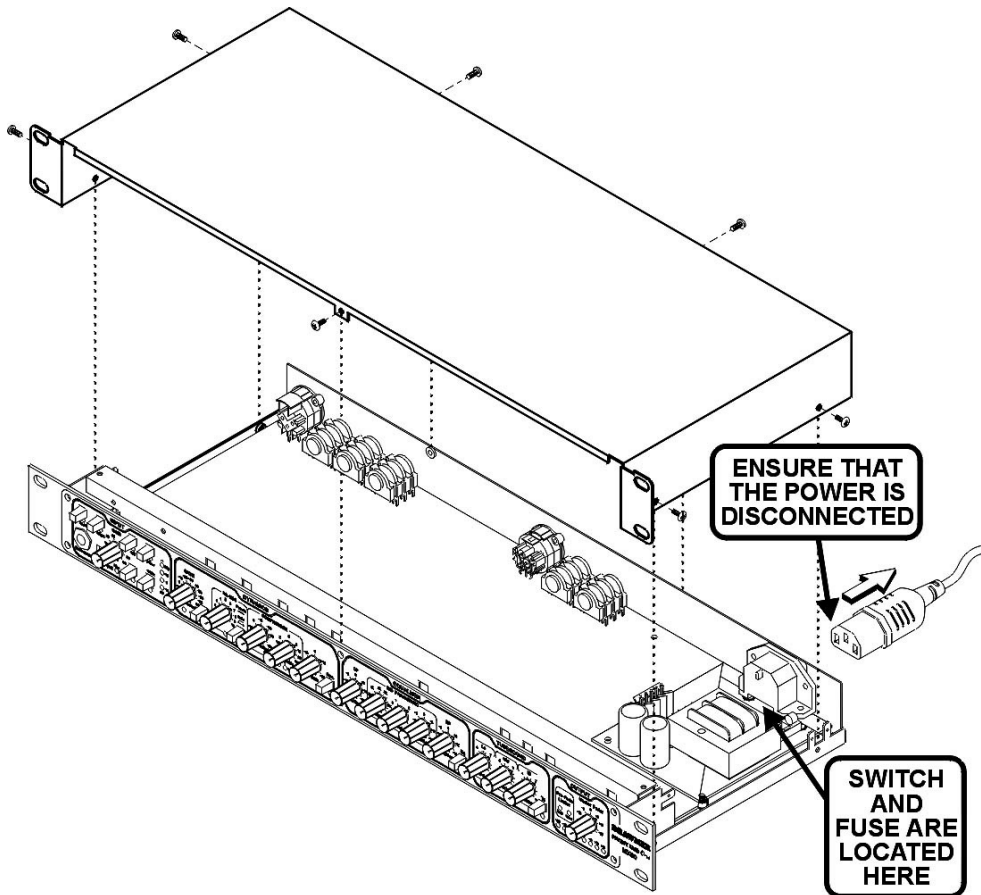

XXXXXXXXXX XXX XXXXXXXXXXXX XXXXXXX XXXXXXXXXXXX XXX

3. Set the voltage rating and replace the fuse.
4. Replace the cover.

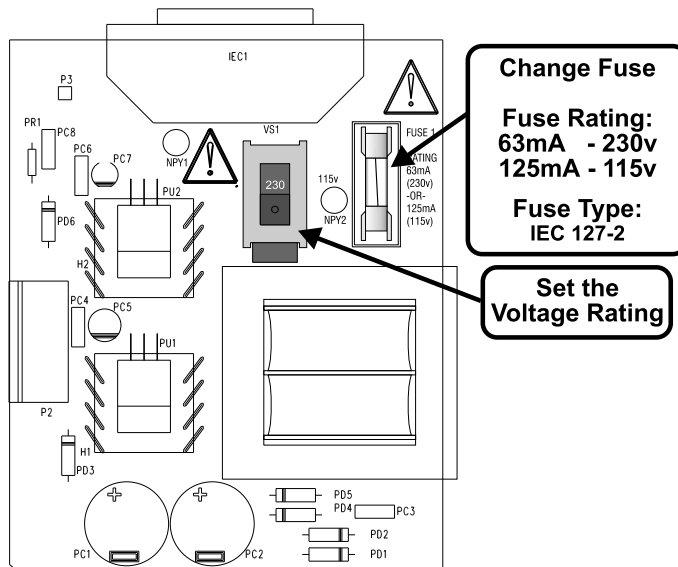

CONTROL DESCRIPTION



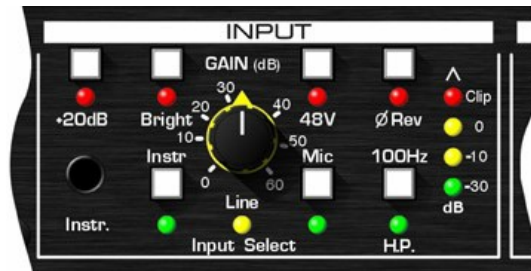





INPUT PRE-AMP STAGE



The preamplifier section is based around Drawmer's own discrete component mic preamp similar to that use in the well respected 1960, which provides very low distortion and a wide dynamic range with an equivalent input noise performance of -134dB .

Source Selection

Mic and Instrument buttons are provided along with status LEDs for the direct selection of mic and line sources. When both buttons are out, the Line input is selected as indicated by the amber Line status LED.

Mic		See Source Selection
48V		Switches on the phantom power if Mic source is selected.
Line		See Source Selection
Instrument		See Source Selection
+20dB		Introduces +20dB of gain in the Instrument section.
Bright		Provides a fixed amount of HF boost designed to approximate the voicing of instrument amplifiers.
Gain		Adjusts the mic gain over a range of 60dB. Adjusts the line/instrument gain over a range of -30dB to $+30\text{dB}$.
ØRev		Inverts the phase of the signal leaving the preamplifier.
100Hz H.P.		High-pass filter. Rolls off the low end to compensate for microphone proximity effect.

DYNAMICS STAGE

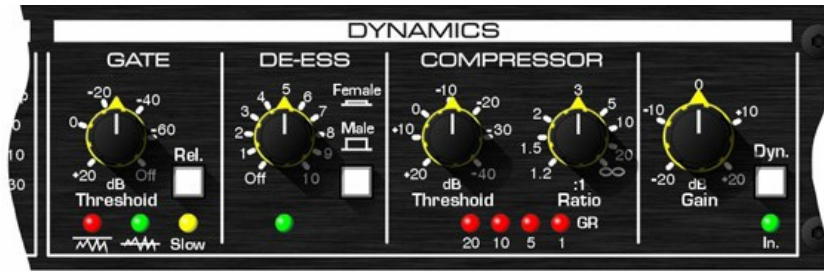

GATE

Threshold



Sets the threshold below which signal is assumed to be noise and therefore muted. Setting the control fully clockwise turns the gate off. Red and green LEDs show the gate's open/closed status.

Release



Sets the release time of the gate. A fast release is suitable for percussive sounds or other sounds having a fast release envelope whereas the Slow setting is better suited to sounds that have a naturally slow decay. The programme adaptive circuitry further optimises the time constants to suit the material being processed.

DE-ESSER

De-Ess



Set the degree of attenuation of sibilant sounds. The MX60's de-esser is highly automated and so very easy to adjust. When this control is turned fully anti-clockwise, the de-esser is off.

Male/ Female



Determines the frequency band in which sibilance is detected. With certain voices, the opposite gender setting may produce better results.

COMPRESSOR

Threshold



Sets the level above which gain reduction will be applied. A four-LED gain reduction meter shows how much gain reduction is being applied up to a maximum of 20dB.

Ratio



Adjusts the compression ratio from 1:1 (no compression) up to infinity:1 (limiting). Use the 1:1 position to 'bypass' the compressor when using the de-esser or gate without compression.

Gain



Provides -30dB to +20dB of gain adjustment to the compressed signal.

Dyn In



Switches the complete dynamics section in or out of circuit.

EQUALISER STAGE

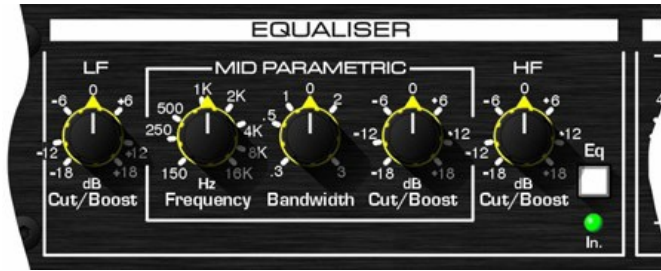

L.F Cut/ Boost



High-pass shelving filter providing up to 18dB of cut or boost below the turnover frequency of 100Hz.

Mid Parametric Frequency



Centre frequency of the mid-range parametric equaliser, variable from 150Hz to 16KHz.

Bandwidth



Bandwidth of mid-range parametric equaliser, variable from 0.3 to 3 octaves.

Cut/ Boost



Controls the amount of mid-range cut or boost up to a maximum of ± 18 dB.

H.F Cut/ Boost



Low-pass shelving filter providing up to 18dB of cut or boost above the turnover frequency of 4.25KHz.

E.Q In



Switches the EQ section in and out of the signal path.

TUBESOUND



Drive Lo



Sets the amount of overdrive in the low frequency range (up to 350Hz).

Drive Mid



Sets the amount of overdrive in the mid frequency range (between 350Hz and 2KHz).

Drive Hi



Sets the amount of overdrive in the high frequency range (from 2KHz upwards).

Ts In



Switches the Tubesound section in and out of the signal path.

OUTPUT STAGE

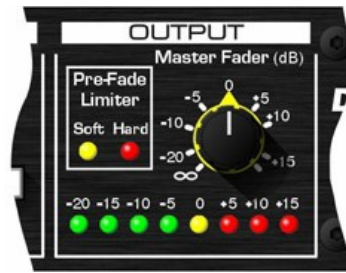

Master Fader



Sets the overall output level of the MX60 from off to +15dBu. An eight-section LED meter shows the output level from -20dBu to +15dBu. (Levels referenced to +4dBu.)

Pre Fade Limiter

Hard

The output stage includes a fixed threshold limiter set at +16dBu. A red LED lights when hard limiting is taking place

Soft

An amber LED will illuminate for soft limiting to show that the signal level is approaching the hard limit point.

OPERATION

Preamp

For use as a front end, the MX60 may be connected directly to the line input of a tape recorder, hard disk recorder, mixer or other line level compatible device. However, by using the line input or the insert return as an input, the MX60 may be used in the insert loop of a mixing console to provide dynamic processing, equalisation or Tubesound processing. In this latter application, ensure that the insert send and return level on your console matches the MX60 input/output sockets that are being used.

When setting the input level, observe the level meter and adjust the Gain control so that the -10dB LED lights frequently with the 0dB LED lighting infrequently on signal peaks. If the Clip LED comes on at all, the gain setting should be reduced.

Dynamics

Setting up the compressor is easiest if the gate and de-esser are initially turned off and the signal kept below the level at which the peak limiter operates. This allows the compressor to be set up in isolation. The ideal ratio setting depends on how firmly the signal dynamics need controlling; as a rule, higher ratios provide a higher degree of control but also tend to be more audible in operation when high levels of gain reduction are required. If in doubt, start off with a ratio of around 4. The programme adaptive attack and release time constants will automatically adjust to suit the material being processed.

In general, the threshold should be set to give a maximum reading on the gain reduction meter of between 8dB and 12dB, though the MX60 can compress more heavily if required to do so. In order to avoid over compression, it is worth considering applying a more cautious amount of compression during recording and then apply further compression while mixing.

Compressing during a mix will increase the subjective level of background noises during pauses and quiet passages but, unless the noise contamination is serious, the gate section will be able to attenuate it to a very high degree without compromising the wanted signal. The gate threshold should always be set as low as possible while still attenuating noise during pauses. If the threshold is set higher than necessary, some of the wanted signal may be cut off making the gate action audible.

Finally, set the compressor's Gain control to give the required output level using the output level meter (with the Output control in its 0dB calibrated position) and the limit activity LEDs to guide you. The limiter LEDs should only light briefly on extreme signal peaks unless you're deliberately driving the limiter hard to create a special effect.

Setting the de-esser is very straightforward as most of the hard work is done by the intelligent circuitry. Select Male or Female according to the vocal style of the performer and increase the amount of de-essing just enough to reduce the sibilance to an acceptable level. If the de-ess level is set too high, there

may be an audible tonal change in the voice during sibilant sounds, in which case the control should be backed off. The de-esser may also be effective in removing or reducing other unwanted high frequency sound such as string squeaks on acoustic guitars.

Experiment with both the male and female settings to see which gives the best result.

Compressors are sometimes accused of dulling the sound being processed, and a little explanation is needed to understand exactly why that should be. Bass sounds, which contain most of the energy in a typical piece of music, cause the compressor to apply the most gain reduction, so any quieter, high frequency sounds occurring at the same time as the bass sound will also be turned down in level. That is why the cymbals and hi-hats in a heavily compressed drum track seem to dip in level whenever a loud bass drum or snare drum beat occurs.

The program adaptive attack time of the MX60 helps minimise this problem by allowing the leading edges of brighter sounds to pass through the compressor before gain reduction is applied, but in extreme cases, it may be necessary to add brightness to the processed sound using the equalisation section or the high band of the Tubesound section.

If required, the gate may be used on its own with the compressor and de-esser functions disabled. To disable the compressor, turn the threshold to maximum and set a ratio of 1:1. The de-esser limiter has no separate bypass control, but turning the de-ess control to minimum will have the same effect.

Equaliser

The equaliser section has quite conventional controls where the high and low shelving filters provide a gentle and musical means of either cutting or boosting the extremes of the audio spectrum. A little more care is required in setting up the mid parametric equaliser as both the bandwidth and frequency are variable as well as the amount of cut and boost. It's often easiest when setting up to apply maximum boost, then use the frequency control to sweep through the spectrum until you locate the area that needs cutting or boosting. Once located, the degree of cut or boost can be set to a more practical value. The Bandwidth control simply sets the width of the filter so that at narrow settings, the filter only affects a section of the spectrum a few semitones wide. At the widest setting, several octaves are affected, giving a much smoother, more general equalisation. As a general rule, very narrow bandwidth settings are best suited to cutting offending frequencies rather than for boosting if a natural result is desired. Bypassing the EQ takes the whole section out of circuit allowing instant comparison between the untreated and equalised sound.

EQ boost effectively increases signal level, which may result in more limiter activity. Use the Dynamics gain control to reduce the signal level to avoid limiting, unless limiting is required as an effect. This is better than reducing the input level, particularly when Compressing or De-Essing. The dynamics gain control is only effective when Dynamics is switched 'In'.

Tubesound

The Tubesound section is a purely creative tool, so it's up to you how you use it. To create subtle tube amp or tube mic effects, apply the Drive controls sparingly and back off if any distortion becomes audible. However, some instrument sounds will benefit from higher settings where the distortion is used as an effect. Using small amounts of high and low Drive with the mid Drive control turned right down will produce a 'loudness curve' effect while at the same time enhancing high frequency detail. As a rule, distortion will be most evident in the mid band as this is the section of the audio spectrum to which the human ear is most sensitive.

The audible effect of TubeSound is greatly increased when compression is used, so it will probably be necessary to reduce Drive if compression is increased.

As in the case of EQ boost, the output level reaching the limiter is affected by the use of TubeSound, particularly if all three bands are driven above mid range. Use the Dynamics gain control to back off the signal level if necessary to avoid limiting.

Output

The output limiter is designed to be as unobtrusive as possible, but in normal circumstances, the red hard limit light should come on rarely if at all. When recording to a digital machine, the limiter can be used to help prevent digital overloads on unexpected signal peaks. To do this, feed a signal into the MX60, then increase the input Gain so that the limit LEDs are always on. Next, adjust the output fader level so that the signal feeding the digital recorder registers just below full scale on the recorder's own meters. Once the input gain has been reset so that the clip light doesn't normally light, the limiter will only come on if a signal peak occurs that would otherwise cause the digital recorder to overload. The MX60's output stage can add up to 15dB of gain in order to produce adequate output level to drive digital recorders where a nominal +4dBu signal may register only around -12dB FSD on the record meters.

IF A FAULT DEVELOPS

For warranty service please call Drawmer Electronics Ltd. Or their nearest authorised service facility, giving full details of the difficulty. On receipt of this information, service or shipping instructions will be forwarded to you. No equipment should be returned under the warranty without prior consent from Drawmer or their authorised representative.

For service claims under the warranty agreement a service Returns Authorisation (RA) number will be given. Write this RA number in large letters in a prominent position on the shipping box. Enclose your name, address, telephone number, copy of the original sales invoice and a detailed description of the problem.

Authorised returns should be prepaid and must be insured. All Drawmer products are packaged in specially designed containers for protection. If the unit is to be returned, the original container must be used. If this container is not available, then the equipment should be packaged in substantial shock-proof material, capable of withstanding the handling for the transit.

CONTACTING DRAWMER

Drawmer Electronics Ltd., will be pleased to answer all application questions to enhance your usage of this equipment. Please address correspondence to:

Drawmer (Technical) : Coleman St.: Parkgate : Rotherham : S62 6EL : UK
or, E-mail us on : tech@drawmer.com

Drawmer dealers, Authorised service departments and other contact information can be obtained from our web pages on <http://www.drawmer.com>

TECHNICAL SPECIFICATIONS

(Measurements taken using +4dBu balanced input where applicable)

INPUT IMPEDANCE	20K Ω (bal), 20K Ω (unbal)	
MAXIMUM INPUT LEVEL	+21dBu	
LINE INPUT CMR	Better than -40dB	(20Hz - 22KHz)
OUTPUT IMPEDANCE	100 Ω	
MAXIMUM OUTPUT LEVEL	+20dBu	
BANDWIDTH	16Hz to 28KHz -1dB	

NOISE ref +4dBu	Wideband (worst case)	22Hz - 22KHz
AV	-85dB	-90dB

DISTORTION

Typical Input	100Hz	1KHz	10KHz
Unity Gain (+4dBu input, +19dBu output)	< 0.05%	< 0.05%	<0.05%

POWER REQUIREMENTS	115Volt or 230Volt at 50-60Hz, 15VA
FUSE RATING	T63mA for 230Volt, T125mA for 115Volt CONFORMING TO IEC 127-2
FUSE TYPE	20mm x 5mm, Class 3 Slo-Blo, 250Volt working
CASE SIZE	482mm (w) x 44mm (h) x 200mm (d)
WEIGHT (incl packaging)	3.2 Kgs

BLOCK DIAGRAM

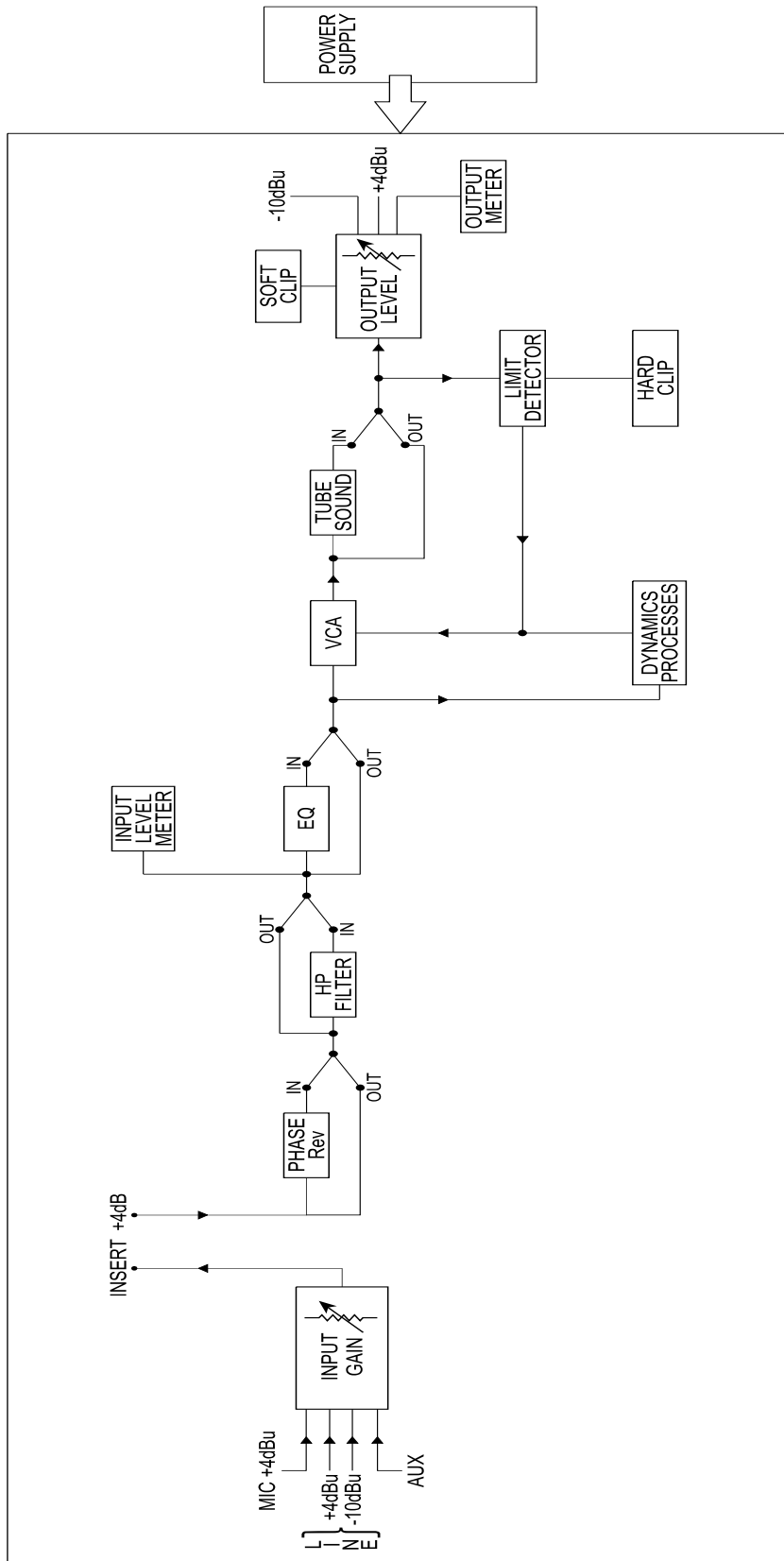

INPUT

+20dB Instr. Line Input Select H.P.
 GAIN (dB) 48V Mic 100Hz dB
 Bright Instr. Line H.P.
 Clip Rev 0 -10 -30

DYNAMICS

GATE

-20 0 +20 dB Threshold
 Off Rel. Slow

DE-ESS

1 2 3 4 5 6 7 8 9 10
 Off Female Male

COMPRESSOR

-10 0 +10 dB Threshold
 1 1.5 2 3 5 10 20 ∞ Ratio
 1 5 10 GR

Dyn.

-20 0 +10 dB Gain
 In.

EQUALISER

-6 0 +6 dB Cut/Boost
 150 250 500 1K 2K 4K 8K 16K 30K Hz
 Frequency Bandwidth Cut/Boost

MID PARAMETRIC

-12 0 +12 dB Cut/Boost
 100 200 500 1K 2K 4K 8K 16K 30K Hz
 Frequency Bandwidth Cut/Boost

HF

-18 0 +18 dB Cut/Boost
 100 200 500 1K 2K 4K 8K 16K 30K Hz
 Frequency Bandwidth Cut/Boost

LF

-18 0 +18 dB Cut/Boost
 100 200 500 1K 2K 4K 8K 16K 30K Hz
 Frequency Bandwidth Cut/Boost

TUBESOUND

4 7 11 Drive
 Lo Mid Hi
 4 7 11 Drive
 4 7 11 Drive
 In.

OUTPUT

-20 -10 0 +5 +10 +15 dB
 Pre-Fade Soft Hard Limiter
 Master Fader (dB)

DRAWMER MX60 FRONT END One

DRAWMER MX60 Session Recall

DRAWMER ELECTRONICS LTD ~ Coleman Street
 Rotherham ~ S. Yorkshire ~ UK

© COPYRIGHT DRAWMER ELECTRONICS LTD 2011

Session No.	
Date	
Artist	
Tape Location	

