

**Earthworks®**  
**FlexWand™**  
HIGH DEFINITION MICROPHONE SYSTEM

A Microphone,  
Boom and Stand  
in a Single Unit

**User's Manual**

**FW430**  
**FW430/HC**

High Definition  
Microphone System



Made in U.S.A.

Earthworks, Inc. • 37 Wilton Rd. • Milford, NH 03055  
603-654-2433, ext. 114 • [www.earthworksaudio.com](http://www.earthworksaudio.com)  
email: [sales@earthworksaudio.com](mailto:sales@earthworksaudio.com) • Printed in U.S.A.

## BEFORE YOU START Guidelines for Positioning FW430 FlexWands

Earthworks near-perfect polar response may require some changes or adjustments in your typical miking practices. Please read the manual to gain a full understanding of the pick-up characteristics of Earthworks cardioid microphones.

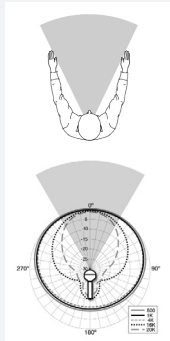

Figure A Usable area with full frequency response of conventional cardioid microphones

There is a dramatic difference in the pick-up area with full frequency response (i.e. no significant high frequency loss) between a conventional cardioid microphone and an Earthworks cardioid microphone with near-perfect polar response. These differences can be seen in comparing Figures A and B. So, when using an Earthworks cardioid microphone you must think “wider” when you position your microphones. The Earthworks cardioid mics have a much greater reach on the sides than conventional

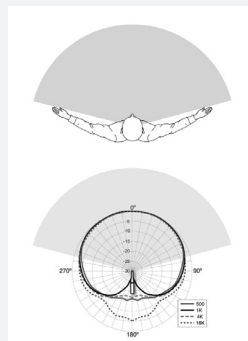

Figure B Usable area with full frequency response of Earthworks cardioid microphones

When miking groups or ensembles the Earthworks near-perfect polar response allows placing the microphones much closer to the instruments or voices resulting in greater detail in the sound and more gain-before-feedback.

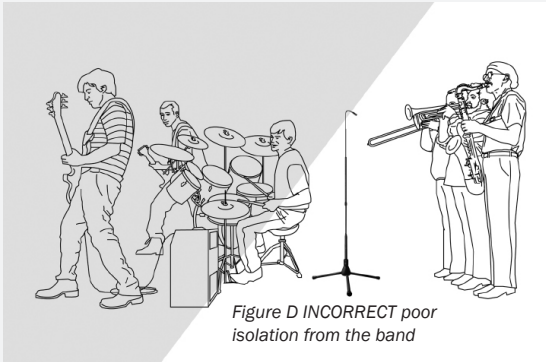

Figure D INCORRECT poor isolation from the band

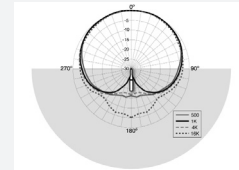

Figure C Rear rejection area of Earthworks cardioid microphones

Earthworks cardioid microphones provide incredible rejection of sound from the rear of the microphone. Notice in Figure C that this dead area of the microphone covers 180 degrees. Figure D shows the way “not to” position the microphone. Figure E shows the “correct” way to position the microphone and obtain the greatest amount of rejection of sounds coming from the rear of the microphone. Following these guidelines will provide incredible results. You should be more than pleased!

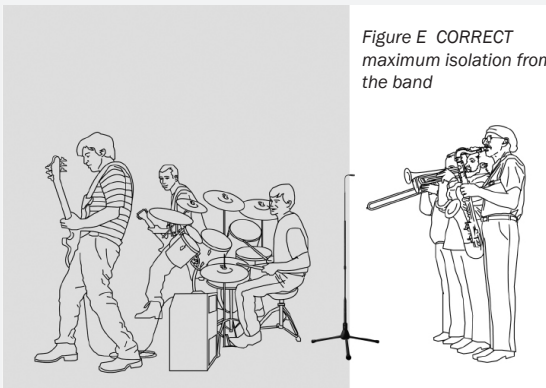

Figure E CORRECT maximum isolation from the band

Congratulations on your purchase of the innovative Earthworks High Definition Microphone™ FW430 FlexWand™ System. We know you will be thrilled with the results you achieve using the FlexWand™ System for both live performance and recording.

### Enclosed with your Earthworks FW430 FlexWand™ System: FlexWand™ Models FW430 & FW430/HC with cast iron base, or FW430TPB & FW430/HC-TPB with tripod base

- 1 – FlexWand™ stand/wand section \*
- 1 – Microphone windscreen \*
- 1 – Base for stand/wand section (either cast iron metal or tripod base depending on model) \*
- 1 – User’s Manual for FlexWand™ System

\* (If you purchased a matched pair of FlexWands, you will receive two each of the items indicated above with an asterisk.)

## FOR ASSEMBLY INFORMATION SEE PAGES 11-16

### THE FLEXWAND™ SYSTEM

You have just purchased an Earthworks High Definition Microphone™ that is incorporated in the FlexWand™ System. The FlexWand™ System is a totally new concept in microphones. It is a combination of a High Definition Microphone™ and a low profile microphone stand and boom as a single unit. It allows the microphone head to be positioned as high as 4.7 feet and as low as 10 inches from the floor or anywhere in between using the tripod base. Using the cast iron base (which is 4 inches lower) changes the maximum height to 4.45 feet and minimum height to 6 inches. Best of all there are no visible wires or cables above floor level. Visually it is low profile, smooth, sleek and clean. The FlexWand™ is the ideal solution for applications where the utmost in sound quality and a low profile is required.

The FlexWand™ is ideal for miking a variety of applications such as acoustic instruments and ensembles, amplified instruments and vocal solos. Now you don’t have to find a microphone, attach the mic clip to the stand and then dress the cable around the stand. Just pick up the FlexWand™, position it and plug the mic cable into the base. You are done! Best of all it is neat and clean visually with no unsightly microphone cable wrapped around the stand and boom. And, it sounds spectacular!

**THE UNIQUE TECHNOLOGY INCORPORATED IN THE FLEXWAND™ WILL PROVIDE EXCEPTIONAL RESULTS. HOWEVER, THESE MICROPHONES DO NOT WORK LIKE CONVENTIONAL MICROPHONES, SO TO ACHIEVE THE GREATEST RESULTS, PLEASE TAKE THE TIME TO READ THE NEXT FEW PAGES:**

### **ABOUT HIGH DEFINITION MICROPHONES™**

During the last decade it has become commonplace for sound recording and broadcast equipment to accommodate extended frequency responses up to and beyond 100kHz. With few exceptions, even the very best of conventional professional microphones do not offer frequency responses above 20kHz. However, making a High Definition Microphone™ involves far more than extending the frequency response. Impulse response, diaphragm settling time and pristine low distortion high current electronics are also key elements. Earthworks' founder David Blackmer foresaw the need for higher quality microphones. Earthworks has been offering High Definition Microphones™, with extended frequency response beyond 40kHz, since 1996. Earthworks High Definition Microphones™ have an extremely clean, natural on-axis pickup, and smooth, uncolored off-axis response due to their near-perfect polar patterns. Cardioid models of High Definition Microphones provide high front-to-back rejection that makes them superb for a wide range of applications including sound reinforcement, broadcast in addition to recording of voice and musical instruments. You will hear exceptional sound quality that is extremely accurate, detailed, open and crystal clear even on 16 bit, 44.1kHz recording systems as well as analog or digital sound systems that are limited to a 15kHz or 20kHz bandwidth. You will hear a remarkable improvement in sound quality on nearly all audio systems when using Earthworks High Definition Microphones™.

### **EXTENDED FREQUENCY RESPONSE**

The FlexWand™ System incorporates a High Definition Microphone™ with a 30kHz high frequency response that enables it to pick up high frequency overtones that conventional microphones miss. In addition, it's extremely fast impulse response that allows it to pick up transients far more accurately. The exceptionally short diaphragm settling time will enable you to hear subtle details that conventional microphones mask. The audible difference between an Earthworks High Definition Microphone™ and conventional microphones is as dramatic as the difference you see when comparing conventional video and high-definition video. It is most impressive. We again urge you to carefully read the next 8 pages to gain a greater understanding of how fully utilize the FlexWand™ System.

## **Utilizing Earthworks Near-perfect Polar Response**

### **Near-perfect Polar Response**

Conventional cardioid microphones typically have poor polar response. They will have a relatively uniform (i.e. flat) frequency response at the front of the microphone (on-axis or 0 degrees), meaning they will uniformly reproduce high frequencies, mid frequencies and low frequencies with a uniform level. However, if you move to either side of the microphone (90 or 270 degrees) there will be a dramatic loss in high frequency response. Perhaps the most telling demonstration of this is attempting to place three singers on a single conventional cardioid microphone (one at the front and the other two singers on the sides). The singers on the sides of the microphone will sound muddled and undefined due to the loss of high frequencies at the sides of the microphone (off-axis). In figure 1a you will see a perfect cardioid polar pattern which will pick up all frequencies uniformly at the front and the sides of the microphone. Figure 1b shows the polar response of a typical conventional cardioid microphone. Notice the severe loss of high frequencies at the sides of the microphone. Figure 1c is the near-perfect polar response of an Earthworks microphone. The Earthworks microphone has a uniform frequency response at the sides of the microphone that is within 3db of the on-axis response at any frequency.

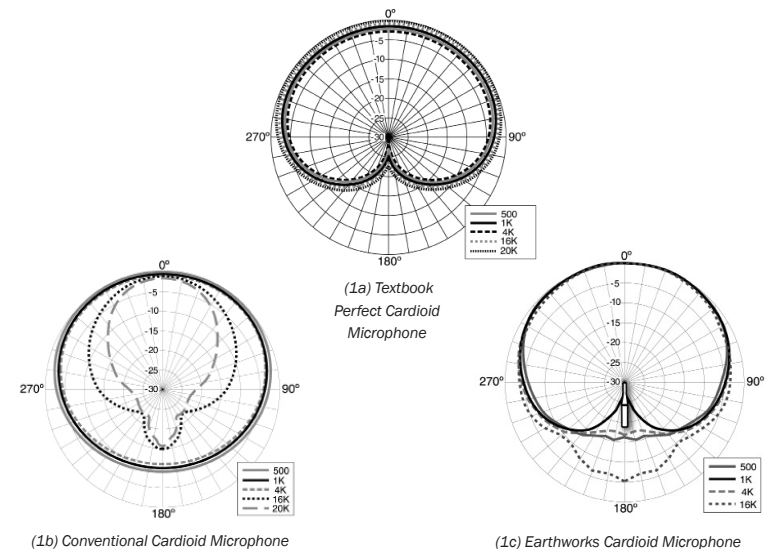

Figure 1. Differences Between a Perfect, Conventional and an Earthworks Cardioid Microphone

The Earthworks cardioid microphones will pick up sounds with nearly the same fidelity at the front and the sides of the microphone. This is a remarkable technical achievement and one that will provide incredible results for you.

## Conventional Polar Response vs. Near-perfect Polar Response

Before reading this information, if you were asked to spread your arms to indicate the width of the pick-up pattern of a conventional cardioid microphone, you would probably indicate something like shown in Figure 2a. The actual polar response of a typical conventional microphone (with full frequency response, i.e. no loss of high frequencies) is illustrated in Figure 2b. Notice that the shaded area in Figures 2a and 2b is virtually the same. Outside of the shaded area there will be a substantial loss of high frequency information.

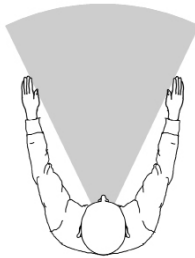

Figure 2a. Typical pick up area (with full frequency response) of a conventional cardioid microphone indicated by extending arms

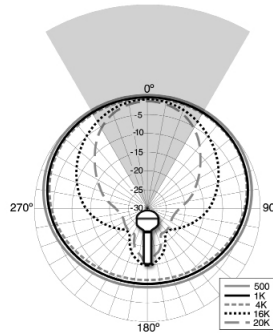

Figure 2b. Typical polar pattern (with full frequency response) of a conventional cardioid microphone

In contrast, if one were asked to spread their arms to indicate the width of the pick-up pattern of an Earthworks cardioid microphone, they would indicate something like shown in Figure 3a. The actual polar response of an Earthworks cardioid microphone (with full frequency response, i.e. no loss of high frequencies) is illustrated in Figure 3b. Again, notice that the shaded areas in Figures 3a and 3b are virtually the same. Notice on the Earthworks microphone (Figure 3b) that even outside the shaded area there is a very minimal change or loss in the level of high frequency information.

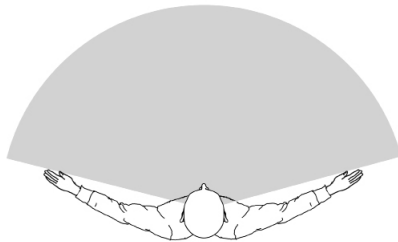

Figure 3a. Typical pick-up area (with full frequency response) of an Earthworks cardioid microphone indicated by extending arms

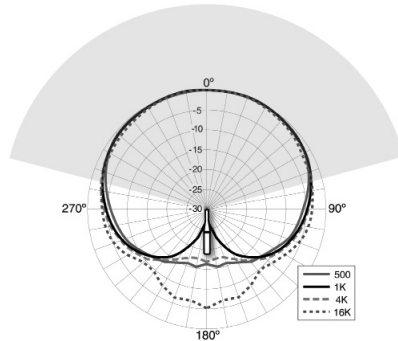

Figure 3b. Typical polar pattern (with full frequency response) of an Earthworks cardioid microphone

## How Earthworks Near-perfect Polar Response Can Benefit You

There are several ways near-perfect polar response can benefit you.

1. Use of fewer microphones
2. Ability to place microphones closer to the sound source for more gain before feedback
3. No spotlighting or highlighting
4. More rejection of sounds from the rear of the microphone
5. Instruments or singers on the sides of the microphone enjoy the same quality as those in front of the microphone.

## Fewer Microphones Required

The taller FW730 is recommended for use with choir, even though the FW430 Series is not, the following illustrations of choir use clearly show the advantages of the FlexWand's near perfect polar response. Referring to Figure 2b, notice how narrow the pick-up pattern is on a conventional cardioid microphone. In comparison, notice how much wider the pickup pattern is on the Earthworks cardioid microphone (Figure 3b). Keep in mind that the shaded areas in these figures indicate the area where you can obtain the full frequency response of the microphone without a significant loss of high frequencies.

Conventional microphones (Figure 2b) only provide a narrow window (or area) in which they can pick up sounds with full frequency response. Figure 4 below, shows an 80-voice choir miked with conventional microphones. It takes 6 conventional microphones, placed 6 feet in front of the choir, to adequately cover the choir with the full frequency response of the microphones.

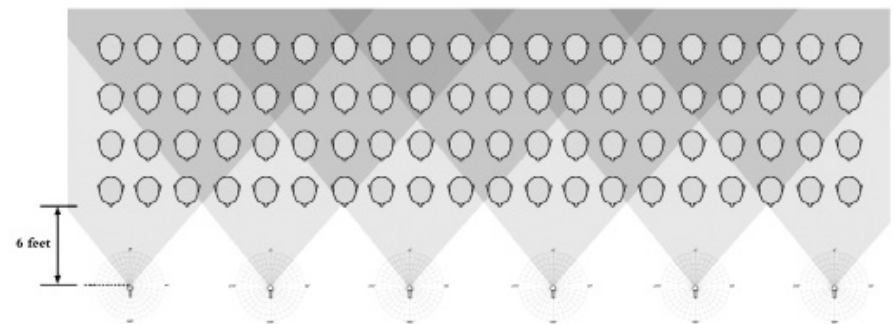

Figure 4. An 80-voice choir miked with 6 conventional microphones at 6 feet

In contrast, the near-perfect polar response of Earthworks cardioid microphones provide a wider pickup pattern (or area) where you can obtain the full frequency response of the microphones. Figure 5 on the following page, is the same 80-voice choir is covered using only 3 Earthworks cardioid microphones.

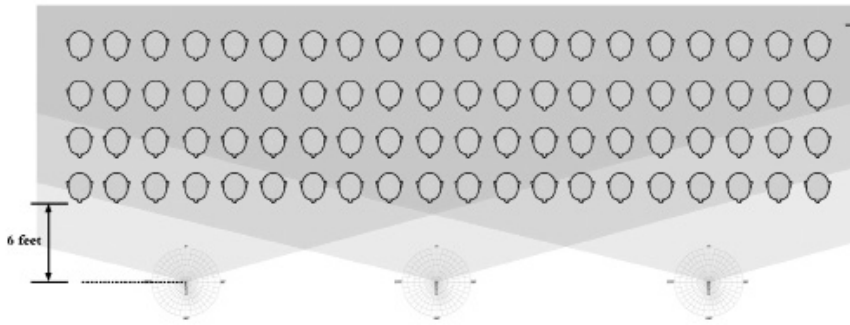

Figure 5. An 80-voice choir miked with 3 Earthworks microphones at 6 feet

### Closer Miking Provides Additional Gain Before Feedback

Seasoned sound engineers know that placing a microphone closer to the sound source will result in additional gain before feedback. Figure 6 below, shows the same 80-voice choir miked with 3 Earthworks cardioid microphones, however, notice that the microphones are placed 3 feet in front of the choir rather than at 6 feet as indicated in Figures 4 and 5.

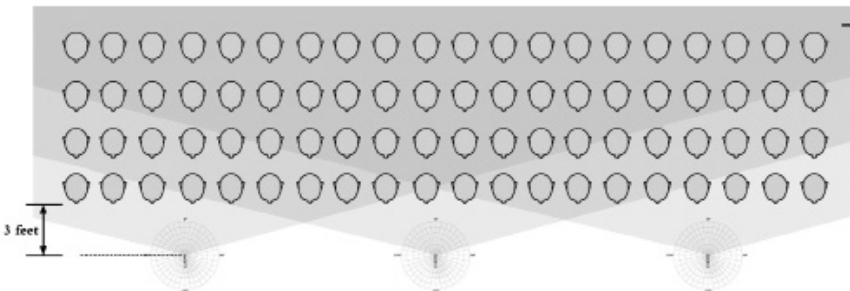

Figure 6. An 80-voice choir miked with 3 Earthworks microphones at 3 feet

In contrast, Figure 7 shows the same choir miked with 6 conventional cardioid microphones placed 3 feet in front of the choir. Notice the blank coverage spots in the pick-up area. This illustrates that placing conventional microphones 3 feet in front of the choir would require even more microphones to adequately cover the choir.

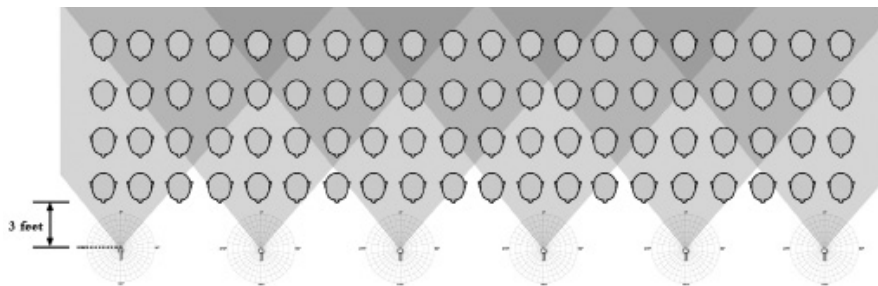

Figure 7. An 80-voice choir miked with 6 conventional microphones at 3 feet

Figure 8 below, shows that it would actually take 12 conventional cardioid microphones to provide the same coverage as 3 Earthworks cardioid microphones, when placed 3 feet in front of the choir.

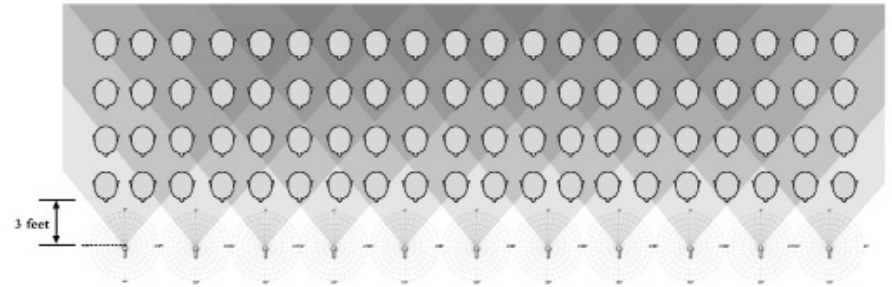

Figure 8. An 80-voice choir miked with 12 conventional microphones at 3 feet

Three characteristics of Earthworks microphones will provide more gain before feedback: (1) Smooth off-axis response, (2) picking up far less sound from the rear of the microphone and (3) wider usable polar-response that allows microphones to be placed closer to the source. Each of these characteristics will provide more gain before feedback, however, when you have all 3 it is somewhat remarkable.

The near-perfect polar response provides a smooth off-axis response in addition to a much wider pick-up pattern with the full frequency response of the microphone. With a wider pick-up pattern, the microphone can be moved closer to the source (in this case singers) and obtain even more gain before feedback.

### Spotlighting

Conventional microphones typically have problems with highlighting or spotlighting when used on choirs. This is caused by the significant changes in frequency response of sounds that are picked up off-axis. This phenomenon will cause singers in a given frequency range to sound louder than others not in that frequency range. This causes certain singers to stick out above the rest making it difficult to achieve a good balance between all of the voices in the choir. In contrast, the uniform off-axis response of Earthworks microphones greatly reduces this phenomenon allowing a uniform balance of choir voices to be achieved much easier.

### Rejection of Sounds Behind the Microphone

A textbook perfect cardioid microphone will pick up sounds uniformly at the front and sides of the microphone. However, the level (in dB) on the sides of the microphone will be slightly less (as much as 6dB). Even though the level at the sides of the microphone may be lower, the frequency response should remain uniform (i.e. no loss of high frequencies). The textbook perfect cardioid microphone is very dead at the rear of the microphone. The polar response of a perfect cardioid microphone is shown in Figure 9a. Notice that at 180 degrees the level is down 30 dB or more.

This is what provides the directional characteristics of a cardioid microphone, in that it will pick up at the front and the sides and picks up far less at the rear, therefore making the microphone directional. However, this is textbook theory. This is much different in practice with real (imperfect) microphones used in the real world.

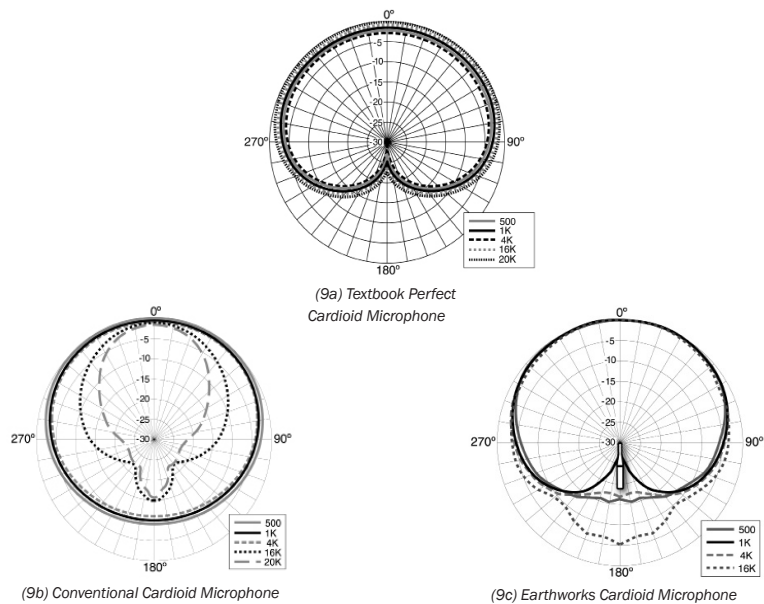

Figure 9. Differences in the Rear Polar Response Between a Perfect, Conventional and an Earthworks Cardioid Microphone

Figure 9b shows the polar response of a typical conventional cardioid microphone. Notice at 500Hz, 1kHz and 4kHz the pick-up pattern is almost an omni pattern, however, these three frequencies are down 10dB in level in reference to their level at the front of the microphone (0 degrees). In contrast 16kHz and 20kHz are down 15dB at the rear of the microphone. We need to look at one important fact. Which frequencies are most audible, 500Hz to 4kHz, or 16kHz to 20kHz? Without question the frequencies between 500Hz and 4kHz are vastly more audible or predominant than those between 16kHz and 20kHz. This shows that the typical conventional microphone in Figure 9b will be somewhat less sensitive at the rear of the microphone, but by only about 10dB in the frequency range between 500Hz and 4kHz.

Looking at the Earthworks cardioid polar response in Figure 9c shows that it has far more rejection in 500Hz to 4kHz frequency range at the rear, than the conventional microphone shown in Figure 9b. In Figure 9c, see that 1kHz is down by 30dB or more, while 500Hz and 4kHz are down 15dB. Also notice that 16kHz and 20kHz are only down 5dB to 10dB. But remember that these high frequencies are far less audible than those between 500Hz and 4kHz.

What we have reviewed so far is technical information shown on charts and graphs. Now let's look at what happens in the actual use and application of these two types of cardioid microphones. If you were to take the typical conventional cardioid microphone in your hand and talk into the front of the mic and while you are talking, rotate the microphone 180 degrees and talk into the rear of the microphone, you would notice some reduction in the audible level of your voice. In contrast, if you were to do the same exercise with an Earthworks cardioid microphone, when you started talking into the rear of the microphone your voice would be nearly inaudible. This practical demonstration shows how dead the Earthworks cardioid microphones are at the rear. As a general guideline, you can consider the coverage area from 90°, 180° to 270° the dead zone of an Earthworks cardioid microphone as illustrated in Figure 10.

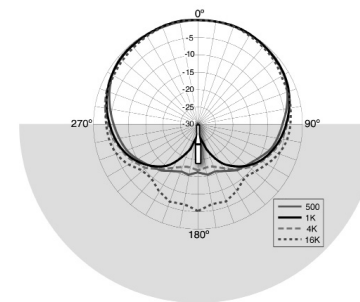

Figure 10. Rear Polar Response of an Earthworks Cardioid Microphone

When miking choirs with an orchestra or band in front of the choir, the rear rejection of sounds from an Earthworks cardioid can be a real benefit. When positioning the Earthworks microphone, make sure that the rear of the capsule is facing the direction of the orchestra or band as shown in Figure 11.

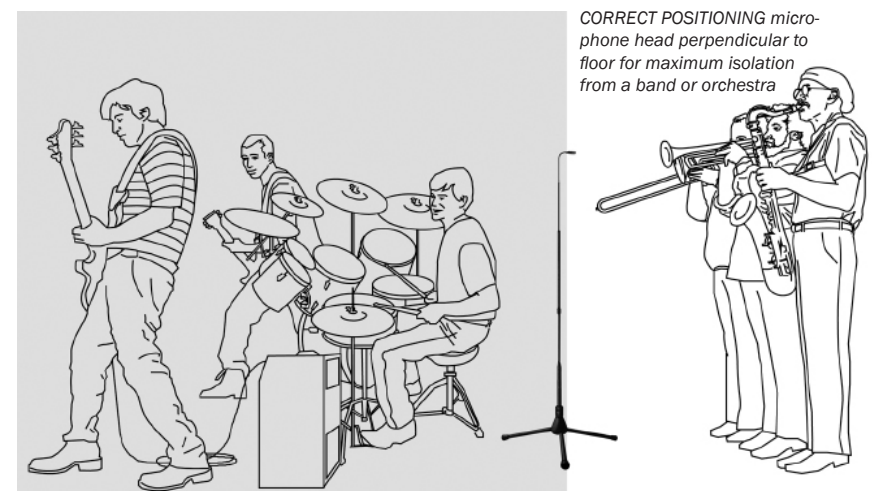

Figure 11. Proper Positioning of an Earthworks Cardioid Microphone with an Orchestra or Band behind the Microphone

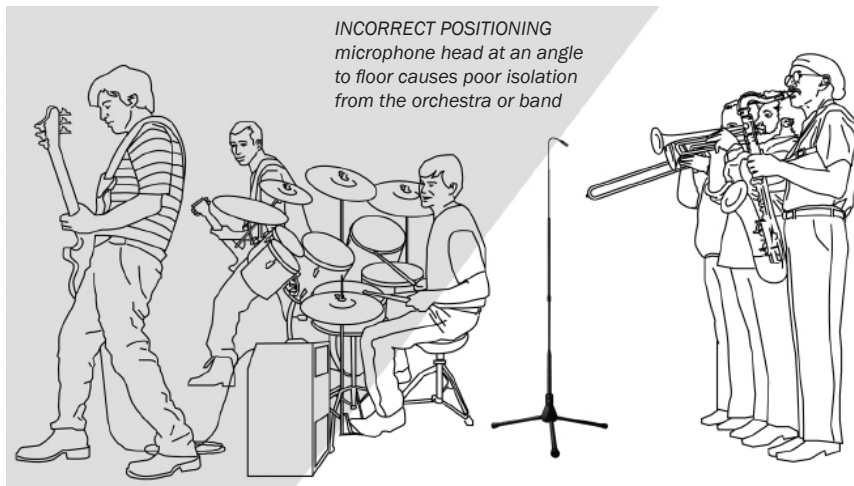

Figure 12. Improper Positioning of an Earthworks Cardioid Microphone with an Orchestra or Band behind the Microphone

Notice in Figure 12 what happens if the rear of the Earthworks cardioid microphone is not positioned toward the orchestra or band.

### OBTAINING A GREATER UNDERSTANDING THE FlexWand™

As you have just read, the near-perfect polar response of the FlexWand™ provides you with many advantages over conventional microphones, not to mention the dramatic increase of fidelity with a High Definition Microphone™.

You can easily place the FlexWand™ two or three feet in front of a choir or vocal group and achieve outstanding results with incredible sound quality and a substantial increase in gain before feedback. It is suggested that when miking choirs, that you use a high pass filter (low-cut) on your console and set it somewhere in the 120Hz range. This will increase your gain before feedback even more. You can also achieve more gain before feedback by boosting the FlexWand™ with EQ at 1.5kHz and 5kHz. If this starts to sound too thin, you can boost at 500Hz to add some warmth and bottom end. The information in this manual should provide you with a good basic understanding of the FlexWand™ and it's unique technology. As you continue to use the FlexWand™ you will find additional ways to improve your results in using this unique microphone system.

### IDENTIFICATION OF THE FLEXWAND™ ELEMENTS

In this manual we will refer to the various elements of the FlexWand™ System. In Figure 13 all of the elements of the FlexWand™ System are identified. Please review this information:

Figure 13  
The FW430TPB FlexWand™ Elements



### The FW430 FlexWand™ Comes in Two Versions

The FW430 comes with a 12 lb. cast iron base and the FW430TPB comes with a collapsible tripod base.

**The FW430TPB with a Tripod Base has a metal sleeve stored inside the tripod base, as shown in Fig. 14a**

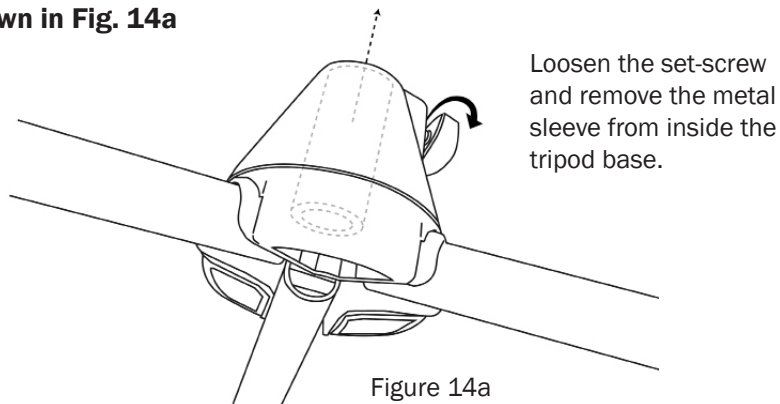

**Remove the metal sleeve from inside the tripod base as shown in Fig. 14b**

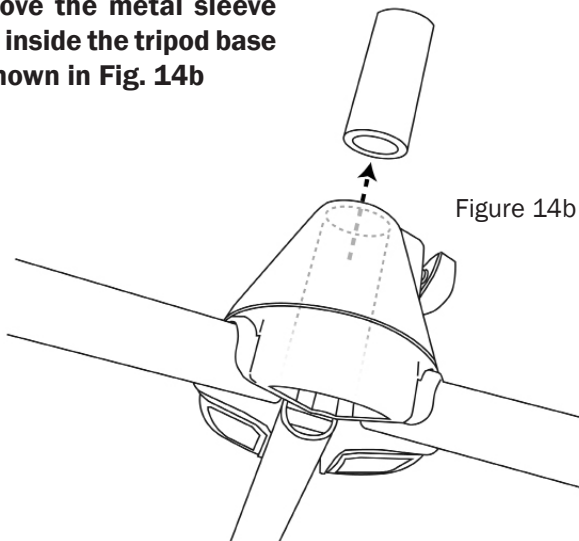

### The FW430 FlexWand™ Comes in Two Versions

The FW430 comes with a 12 lb. cast iron base and the FW430TPB comes with a collapsible tripod base.

#### Connecting the Tripod Base to the FW430TPB

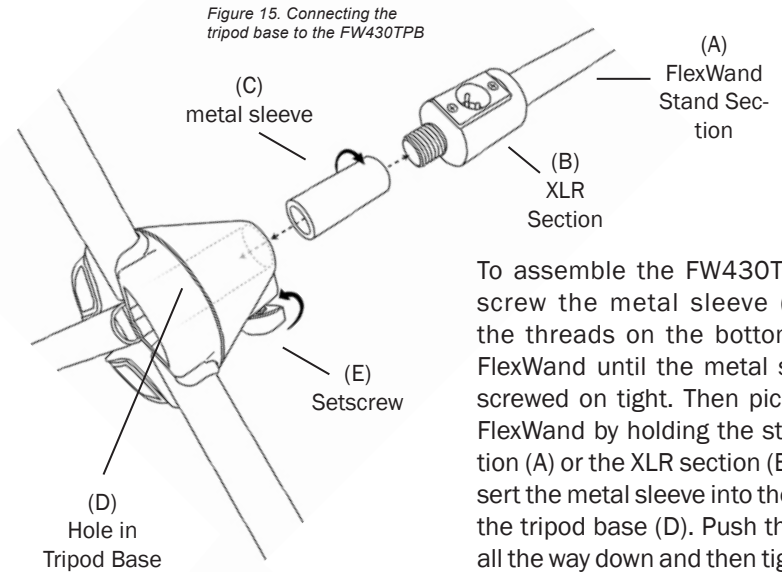

#### Connecting the Cast Iron Base to the FW430

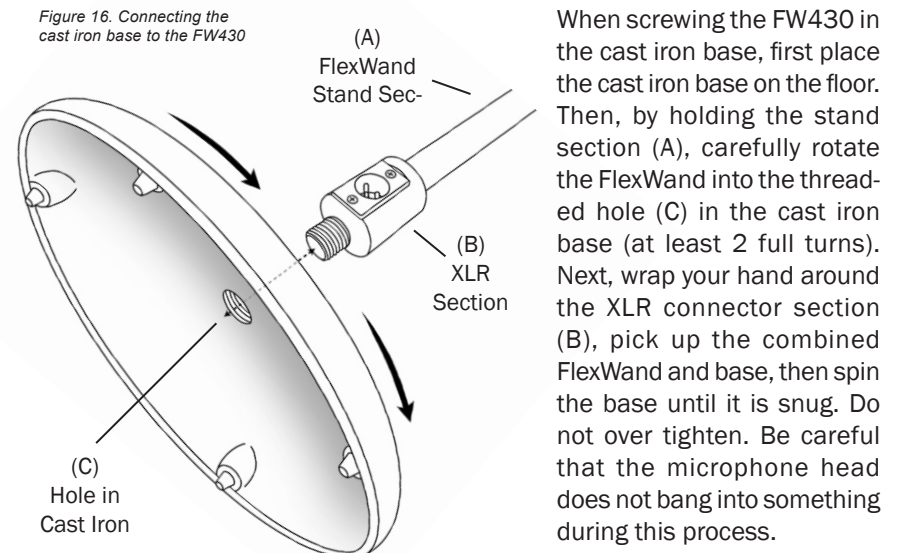



## USING THE FLEXWAND™ AT MAXIMUM HEIGHT

There may be some applications where you will probably want to have the FlexWand™ at its maximum height of 4.7 feet. This is easily achieved by pointing the wand straight up and then loosen the clutch and slide the sleeve up until it mates into the “sleeve mating coupler.” Make sure it is all the way up and firmly seated over the mating coupler (see Figure 17).

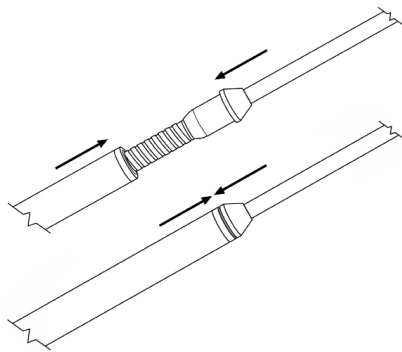

Figure 17. Seating the Sleeve over the Mating Coupler

This will insure that the FlexWand™ is perfectly straight up and down from all directions. Then position the microphone head to any position that you desire with the mini-flex at the end of the wand (see Figure 18).

Figure 18. Positioning the Microphone Head with the FlexWand at Maximum Height



Figure 19. FW430 series used in miking a children's choir at maximum height.

The near-perfect cardioid pattern of the FlexWands allow placing the microphone heads as close as 18 inches in front of the singers and still have a uniform, balanced pickup, with no highlighting or spotlighting of the singers directly in front of the microphones. You could never do this using conventional mics. See

## USING THE FLEXWAND™ AS A BOOM

In the “boom mode” the FlexWand™ can mike anything just like a conventional microphone on a boom stand. This can be used when you want the FlexWand™ microphone lower for such applications as small vocal groups or vocal solos. (see Figure 20).

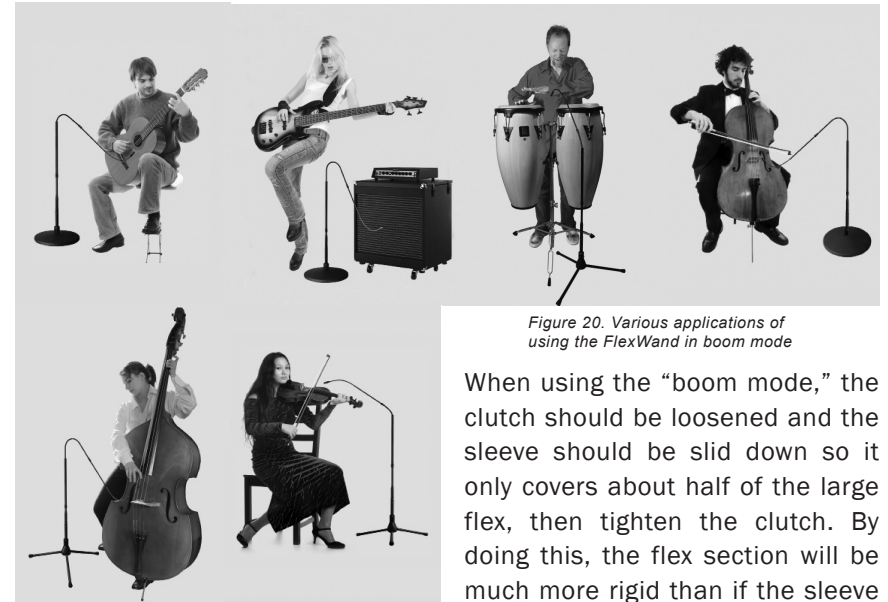

Figure 20. Various applications of using the FlexWand in boom mode

When using the “boom mode,” the clutch should be loosened and the sleeve should be slid down so it only covers about half of the large flex, then tighten the clutch. By doing this, the flex section will be much more rigid than if the sleeve were slid all the way down.

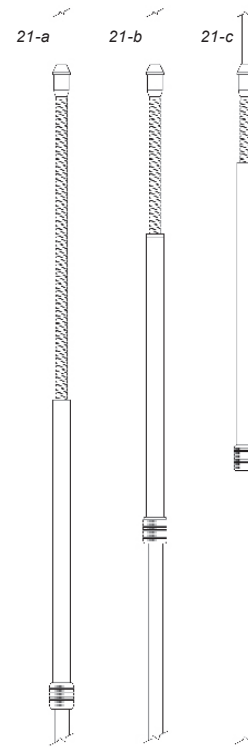
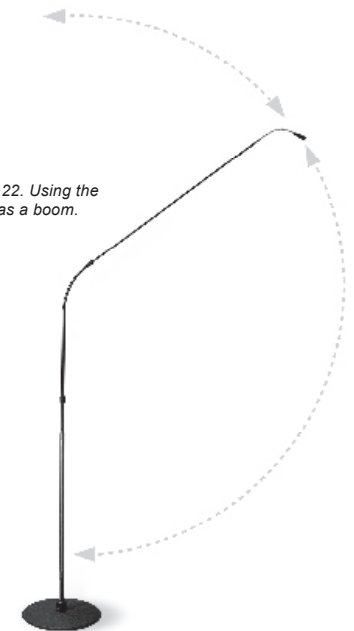

Figure 21-a. Sleeve all the way down  
21-b. Sleeve half-way up  
21-c. Sleeve three-fourths of the way up

You might want to experience this for yourself by first loosening the clutch and sliding the sleeve all the way down (tighten the clutch) and then position the wand at a 45 degree angle (see Figure

Figure 22. Using the Wand as a boom.



21a). Now position the wand at several angles greater and less than 45 degrees and see how it feels.

Then loosen the clutch again and cover only half of the large flex then tighten the clutch (see Figure 21b). Now position the wand at several angles at greater and less than 45 degrees (see Figure 22) to see how the large flex is much more rigid.

The large flex can be made even more rigid by sliding the sleeve up to cover three-fourths of the large flex (see Figure 21c). These adjustments are ideal when you want to position the wand at any position between straight up to a 90 degree angle. If you want to go more than 90 degrees, you will need to re-position the sleeve to uncover more, or all of the large flex, thereby allowing it to be positioned between 90 degrees to nearly 180 degrees.

The highly versatile FlexWand™ High Definition Microphone System is a uniquely creative tool that will provide outstanding sonic results for virtually any recording or live sound application. It is low profile with no visible wires above floor level provides a clean sleek look that will not visually impair or detract from the musical or theatrical performance. The quality construction of the FlexWand™ will provide you with years of exceptional service. If you have any questions, please contact Earthworks Customer Service Department at 603-654-6427, ext. 119.

### FIFTEEN-YEAR WARRANTY

All Earthworks® products (excluding accessories) carry a fifteen-year limited warranty (parts and labor). If you have any problems with your Earthworks products, please contact our warranty/repair department by email at: [returns@earthworksaudio.com](mailto:returns@earthworksaudio.com) or by telephone at (603) 654-2433, ext 119.

## FW430 FLEXWAND™ SERIES SPECIFICATIONS

**FW430** (Cardioid) & **FW430/HC** (Hypercardioid) with cast iron base

**FW430TPB** (Cardioid) & **FW430/HC-TPB** (Hypercardioid) with tripod base

**FW430 Frequency Response:** 50Hz to 30kHz

**FW430/HC Frequency Response:** 100Hz to 30kHz

**Polar Pattern:** Cardioid or Hypercardioid

**Sensitivity:** 10mV/Pa (-40dBV/Pa) (Cardioid); 20mV/Pa (-34dBV/Pa) (Hypercardioid)

**Power requirements:** 24-48V Phantom, 10mA

**Max Acoustic Input:** 145dB SPL (Cardioid); 139dB SPL (Hypercardioid)

**Output Connector:** Female XLR-3 (pin 2+)

**Min Output Load:** 600 ohms between pins 2 & 3

**Noise:** 20dB SPL (Cardioid); 16dB SPL (Hypercardioid)

**Positioning Range:** From 10 in (254mm) to 4.7 ft. (1.4m) with tripod base; and 5 in (127mm) to 4.35 ft. (1.3m) with the cast iron base.

**Dimensions:** Stand 52" long (1.32m), Cast Iron Base 12" (30.48cm) in diameter, 1.1" (2.7cm) high; Tripod Base 23" (58cm) footprint, 6" (15.2cm) high

**Color:** Stand, flex & wand - black; cast iron base - dark gray; tripod base - black

**Unit Weights:** Stand 2 lbs. (.9 kg), Cast Iron Base 12.6 lbs. (5.7kg), Tripod Base 1.6 lbs. (0.73kg)

FW430  
Polar Pattern

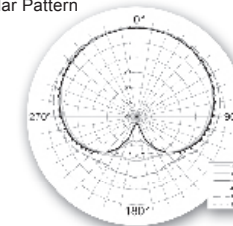

FW430/HC  
Polar Pattern

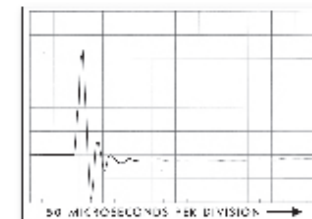
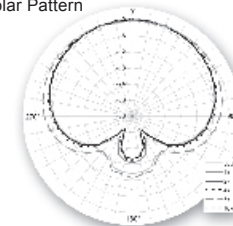

FW430 Impulse Chart