



# BrightEye™ 3

## Analog to SDI Converter with TBC and Frame Sync User Guide

**ENSEMBLE**

D E S I G N S

Revision 4.0 SW v1.0.8

This user guide provides detailed information for using the **BrightEye™ 3** Analog to SDI Converter with Time Base Corrector and Frame Sync.

The information in this user guide is organized into the following sections:

- Product Overview
- Functional Description
- Applications
- Rear Connections
- Operation
  - Front Panel Controls and Indicators
  - Using The BrightEye Control Application
- Warranty and Factory Service
- Specifications
- Glossary

## PRODUCT OVERVIEW

The BrightEye™ 3 Converter is a Time Base Corrector/Frame Synchronizer with composite, component and Y/C inputs. Input signals are digitized to 12 bits of resolution and time base corrected by a noise tolerant tracking circuit. An external reference input allows genlock to a timing reference such as color black.

BrightEye 3 is great for such applications as capturing consumer VCRs into non-linear editing systems.

Input selection, gain controls, and TBC enable is provided through the front panel interface. Input and reference presence are indicated through front panel LEDs. Control and monitoring can also be done using the BrightEye Control application from a personal computer with USB support.

Signal I/O and power is supplied to the rear of the unit. It is powered by a modular style power supply.

A glossary of commonly used video terms is provided at the end of this guide.

## FUNCTIONAL DESCRIPTION

The BrightEye 3 converter can perform analog to digital conversion on a variety of television signal formats, in both the 525/60Hz (NTSC) and 625/50Hz (PAL) line standards. The converter supports the NTSC and PAL composite standards, Y/C, and color difference analog component formats along with serial digital (SDI) video.

As shown in the block diagram on the next page, analog composite video is fed to the converter on a single BNC connector at 1 volt p-p levels (sync tip to peak white). The analog signal is clamped (DC restored) and digitized. This digital representation of the original signal is decoded into luminance and color difference component form using an adaptive comb filter.

Component video inputs in the SMPTE or Beta formats of Luminance (Y), and color difference (R-Y or Pr, and B-Y or Pb) enter the converter through three BNC connectors. They are digitized and clamped and then gain-scaled to component digital levels.

In all cases of analog video input, the resultant digital signal conforms to the ITU-R 601 standard. This is a 4:2:2 component digital signal with a 27 MHz sampling rate. The overall amplitude of the signal can be adjusted with the gain control. This digital signal is fed to the TBC/Frame Synchronizer.

The TBC/Frame Synchronizer performs time base correction and synchronization on its input signal (either analog or digital) to conform its timing to the house reference provided on the external reference input (Ref In). This synchronizing function will automatically align the timing of the converter output so that each new video frame begins at exactly the same time as it does on the reference input. Furthermore, since the original input to the converter may be non-synchronous to the reference, the input video may be running slightly fast or slow with respect to the reference. The synchronizer corrects for this by buffering the signal through a memory FIFO which can hold up to one frame of video.

The output of the TBC/Frame Synchronizer is serialized as a 270 Mb/s bitstream and feeds the electrical BNC connector.

BrightEye 3 is powered by a 12 volt DC universal power supply. This power supply can accept an input voltage between 90 and 230 volts, at 50 or 60 Hertz. It uses a standard IEC line cord and can be used anywhere in the world. It is normal for the converter to be quite warm to the touch when operating.

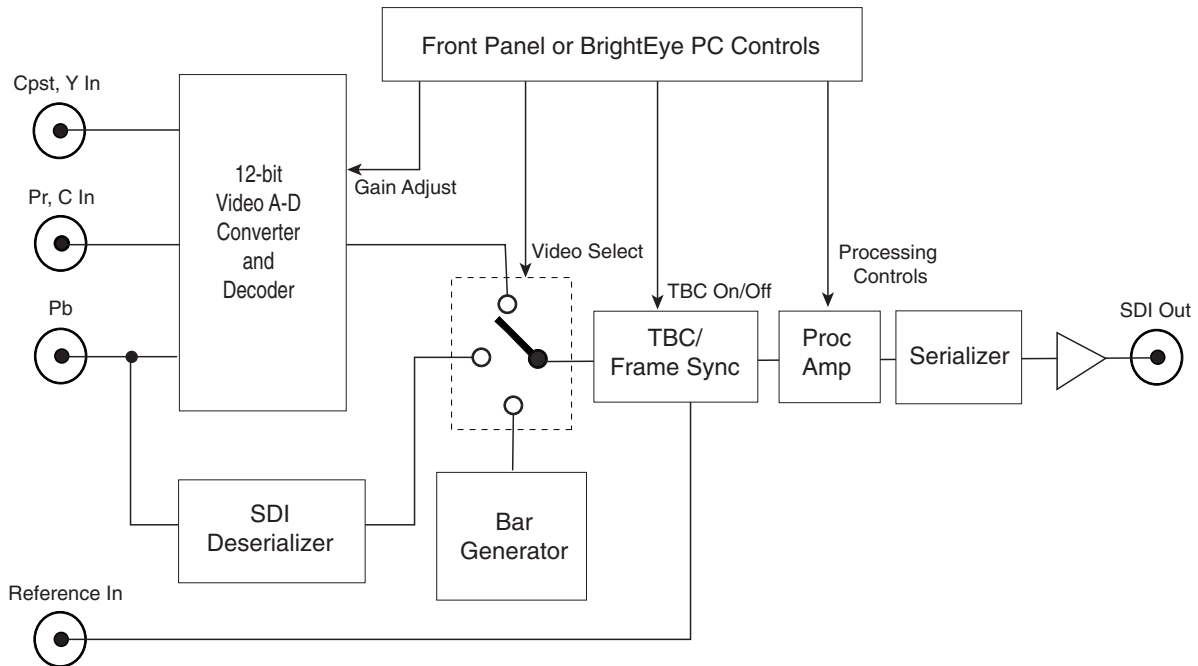

**BrightEye 3 Functional Block Diagram**

## APPLICATIONS

The versatility of BrightEye 3 can be utilized in any number of different applications where conversion of composite/Y/C and component analog video to SDI is required.

### Analog to SDI/Optical Conversion and Distribution

One application, shown in the illustration below, utilizes the full functionality of BrightEye 3 by converting an output from a consumer VCR to an SDI signal for feeding a non-linear editing system. The use of a reference input also allows the converted signal to be synchronous with the house reference.

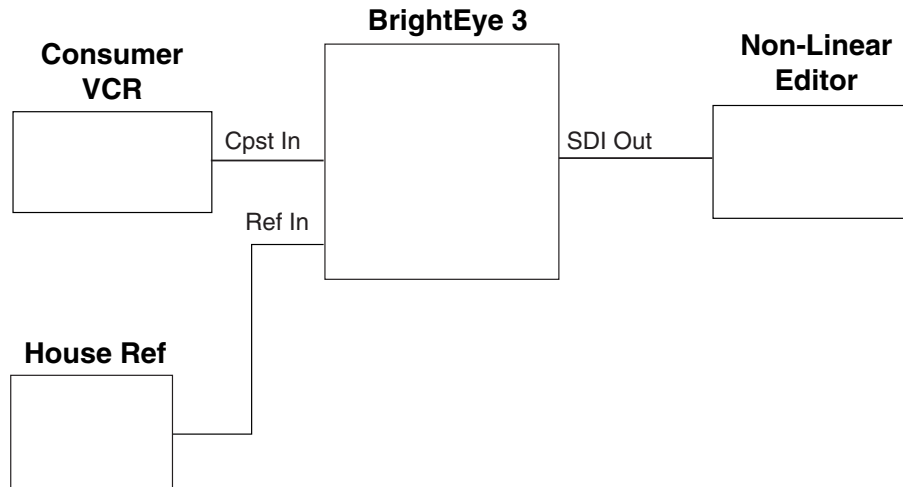

**BrightEye 3 Application**

## REAR CONNECTORS

All connections to the BrightEye converter are made on the rear of the unit. Refer to the illustration below.

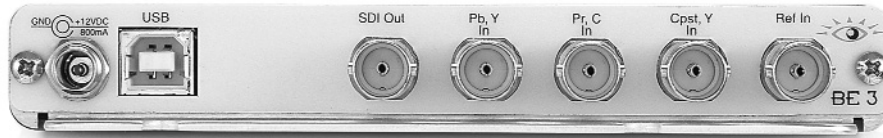

**BrightEye 3 Rear Connectors**

### Power Connection

Connect a modular power supply to the 12 volt DC power input connection on the far left. Use the locking ring to secure it.

### USB Connector

The USB connector is used to provide more comprehensive control, diagnostics, and upgrades to the unit from a PC or Mac. Use the BrightEye Control application included on CD-ROM to make adjustments as described in the **OPERATION** section of this user guide.

### Input/Output BNCS

There are five rear BNC connectors which are used as follows:

#### SDI Out

The Serial Digital Component output of the converter is presented on this connector. This output conforms to the ITU-R 601 standard for serial digital video, with SMPTE 259M serialization at 270 Mb/s.

#### Pb In

This is an internally terminated, 75 ohm input for the following:

- Beta or SMPTE – Pb input

#### Pr, C In

This is the internally terminated, 75 ohm input for the following format signals:

- Beta or SMPTE – Pr (Y-R) input
- S-Video (composite) – C input

**Cpst, Y In**

This is the internally terminated, 75 ohm input for one of the following signal formats:

- Composite (Cpst) – composite input
- S-Video (composite) – Y input
- Beta or SMPTE – Y input

**Ref In**

The reference input connector accepts a composite video signal which is used as the genlock and timing reference for the internal TBC/Frame Synchronizer. Typically the reference signal would be Color Black or Color Bars fed from a master sync generator. This is an internally terminated 75 ohm input.

## OPERATION

Control and operation of the BrightEye 3 converter is performed from the front panel or with the BrightEye Control application.

**NOTE:** Some control settings are only available with BrightEye PC or Mac. These parameters cannot be monitored or controlled with the front panel.

## Front Panel Controls and Indicators

The front panel of the converter, shown in the figure below, provides status indicators and control over video input selection, TBC, and gain.



**BrightEye 3 Front Panel**

### Status Indicators

The following status indicators are provided on the front panel:

#### **In**

Illuminates green when an input for the currently selected video format is detected on the input connector. This indicator does not light when either of the two internally generated test patterns are selected.

#### **Ref (Reference)**

Illuminates green when a reference video signal is present on the Ref In connector.

#### **Source Select**

The currently selected video input will illuminate green.

#### **TBC/Frame Sync**

When illuminated green, the TBC/Frame Sync mode is enabled.

#### **Gain**

Illuminates green when gain is set to unity or red when gain is other than unity.

#### **Pwr (Power)**

Illuminates green when power is applied to the converter and the internal voltage regulator is functioning correctly.

## ADJUSTING PARAMETERS FROM THE FRONT PANEL

Use the **Mode**, **Right Arrow**, and **Left Arrow** buttons to select and adjust parameters from the front panel.

Pressing the **Mode** button activates the front panel for editing and tabs between each section of editable parameters.

Pressing the **Right Arrow** or **Left Arrow** advances the selection within a given section of parameters, or increases (Right Arrow) or decreases (Left Arrow) the value of a selected parameter.

**NOTE:** *The LED of an edited parameter will blink for 15 seconds, after which time its value is stored in memory. If power is interrupted before this 15 second timeout period has elapsed, the edited state will not be saved.*

The controls and their indicators are described below:

### Source Select Mode

This control selects the video input with the following choices:

**Cpst** – Analog Composite Video

**Y/C** – S-Video Composite Video

**Beta** – Component Video in Beta format

**SMPTE** – Component Video in SMPTE format

**Bars** – Selects internal Color Bar Generator

**ChkFld** – Selects internal CheckField Generator

The green indicator under the selected source will be illuminated.

### TBC/Frame Sync Mode

This control turns the TBC/Frame Sync function on/off. Use the left arrow to turn it off, the right arrow to turn on. The indicator illuminates green when it is on.

### Gain Mode

This control adjusts the overall gain of the analog video signals passing through the converter. The right arrow will increase the gain, the left arrow will decrease it. The indicator will illuminate green when the gain is set to its nominal or unity setting. This is the setting which will produce correct digital output levels from an analog input source which itself is at proper level. The indicator will show red whenever the control is adjusted either higher or lower than the nominal setting. The gain can be reset to nominal (green) by pressing both arrows simultaneously.



## USING THE BRIGHT EYE CONTROL APPLICATION

The BrightEye PC and BrightEye Mac applications included on CD-ROM are designed to allow you to configure and control the BrightEye 3 from a personal computer. Installation and instructions for using this software application are given in the PDF manual on disk. If the BrightEye 3 is connected to a computer running this software, the following menus are available for controlling and monitoring the unit.

### Input Menu

- **Input** – select the type of input signal to the unit from the **Input** pulldown as **Composite**, **Y/C**, **Beta**, **SMPTE**, **SDI**, **Bars**, or **Checkfield**.
- **Comb Mode** – use this control set the type of comb filtering desired from **3-Line** or **5-Line**.
- **Setup Removal** – use this control to indicate the presence of setup on the input (in 525 mode only, grayed out in 625). Select **On** for setup removal or **Off** for no setup removal.
- **Signal Mute** – the signal muting control affects the behavior of the module when the video input (either analog or SDI) is lost or interrupted. Set the control for one of the following conditions:

**No Muting** – nothing is done when the input is lost or intermittent. In this case, the module may present a very disturbed output in response to an intermittent input.

**Mute on Noise** – the output will go black if the input is lost.

**Mute on Freeze** – the output will freeze on the last image when the input is lost.

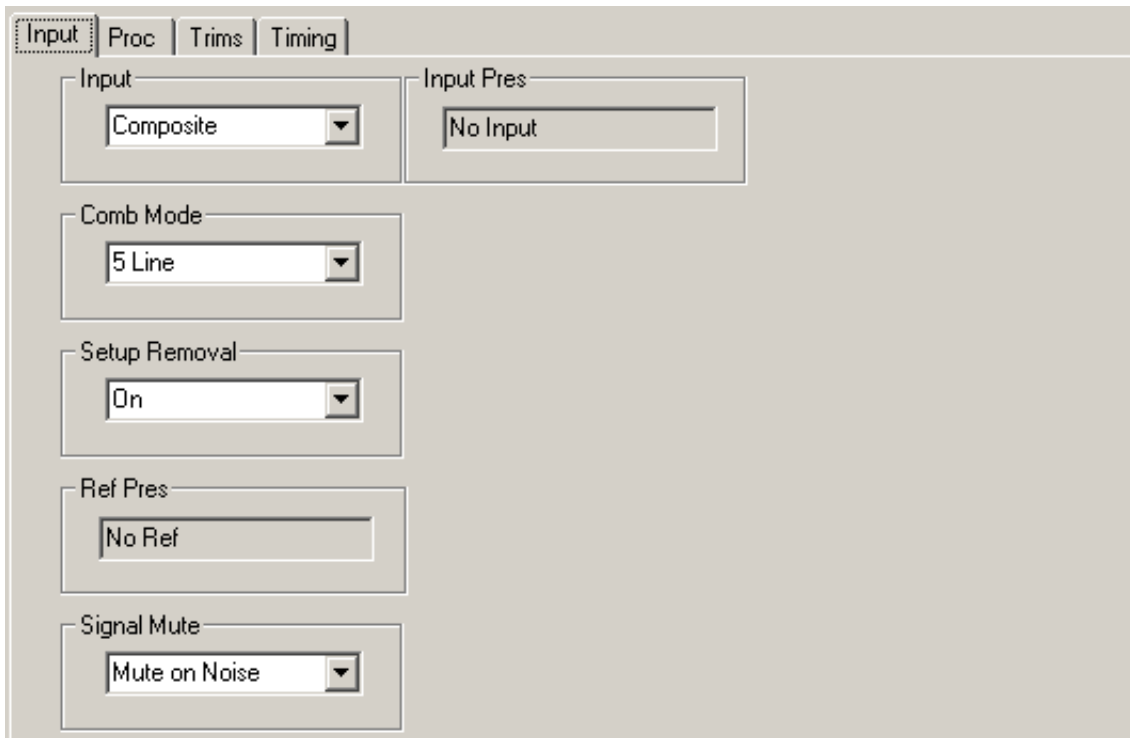

The screenshot shows the 'Input' menu of the BrightEye 3 control application. The interface has a tabbed design with 'Input', 'Proc', 'Trims', and 'Timing' tabs. The 'Input' tab is active. It contains several controls:

- Input:** A dropdown menu set to 'Composite'.
- Input Pres:** A text field containing 'No Input'.
- Comb Mode:** A dropdown menu set to '5 Line'.
- Setup Removal:** A dropdown menu set to 'On'.
- Ref Pres:** A text field containing 'No Ref'.
- Signal Mute:** A dropdown menu set to 'Mute on Noise'.

The following status items are also reported for the unit:

- **Input Pres** – reports the presence and detected line rate of the video input.
- **Ref Pres** – reports the reference input status.

### Proc Menu

A video processing amplifier allows the adjustment of parameters for the analog input signal.

The Proc menu provides the following video processing controls:

- **Gain** – adjusts the overall gain of the analog video signals passing through the converter from 50 to 150%. The front panel indicator will light green when the gain is set to its nominal or unity setting.

This is the setting which will produce correct digital output levels from an analog input source which itself is at proper level. The indicator will show red whenever the control is adjusted either higher or lower than the nominal setting.

- **Chroma** – adjusts the percentage of chroma from 50 to 150%. There is no front panel control or indication of this setting.
- **Pedestal** – adjusts the pedestal level of the signal +/- 5 IRE. There is no front panel control or indication of this setting.
- **Hue** – adjust the amount of hue +/- 90 degrees in 525 mode only. There is no front panel control or indication of this setting.

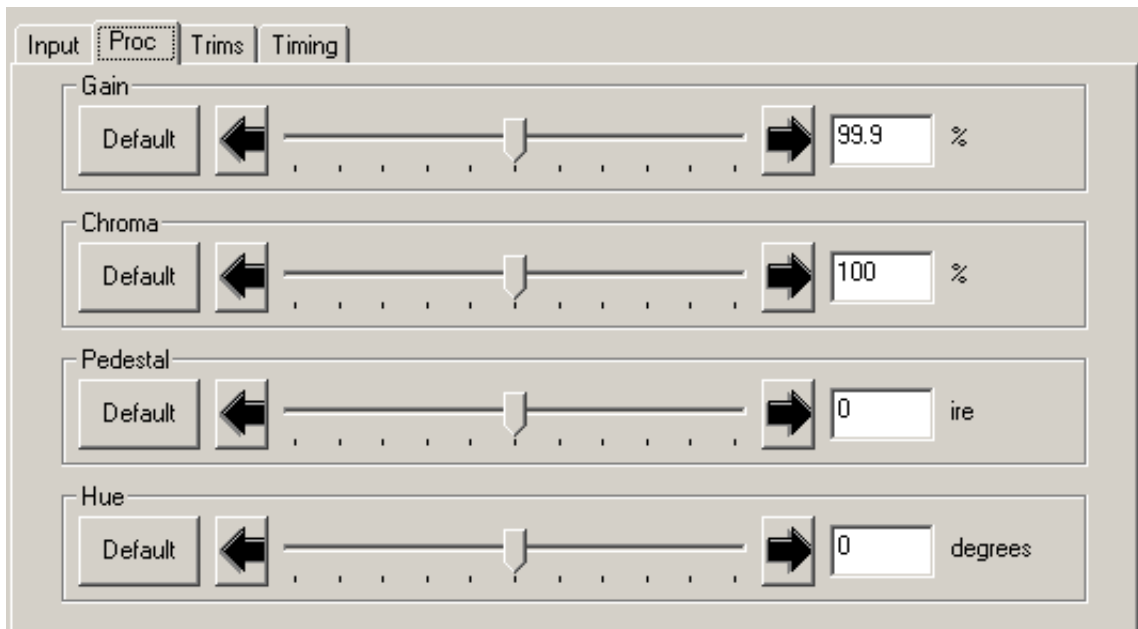

All values can be reset to nominal by selecting the **Default** button next to the control.

## Trims Menu

The Trim menu provides the adjustments below for the component Cr and Cb input video input gain and DC offsets to compensate for incorrect levels on the input sources:

- **Cr Gain** – adjusts the input gain of the Cr channel video ( $\pm 30$ ).
- **Cb Gain** – adjusts the input gain of the Cb channel video ( $\pm 30$ ).
- **Cr Offset** – adjusts the DC offset of the Cr channel.
- **Cb Offset** – adjusts the DC offset of the Cb channel.

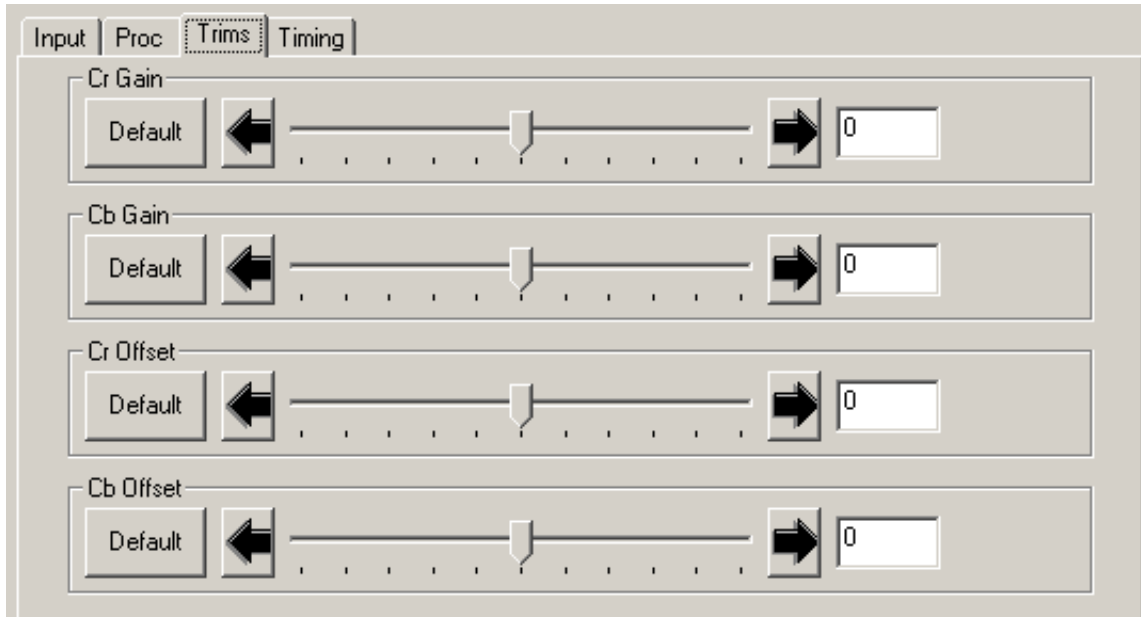

### Timing Menu

Timing adjustments can be made when the Frame Sync function is enabled on the unit.

The Timing menu provides the following controls:

- **Ver Time** – adjusts the vertical timing of the signal in +/- 625 line increments relative to the reference input when Frame Sync is enabled (on). There is no front panel control or indication of this setting.
- **Hor Time** – adjusts the horizontal timing of the signal in +/- 1715 clock increments relative to the input reference when Frame Sync is enabled (on). There is no front panel control or indication of this setting.
- **V Blanking** – set vertical blanking to **Wide** (PAL Lines 1-22 and NTSC Lines 1-20) or **Narrow** (PAL Lines 1-6 and NTSC Lines 1-9). There is no front panel control or indication of this setting.
- **Frame Sync** – turns the Frame Sync function on or off with the menu pulldown.

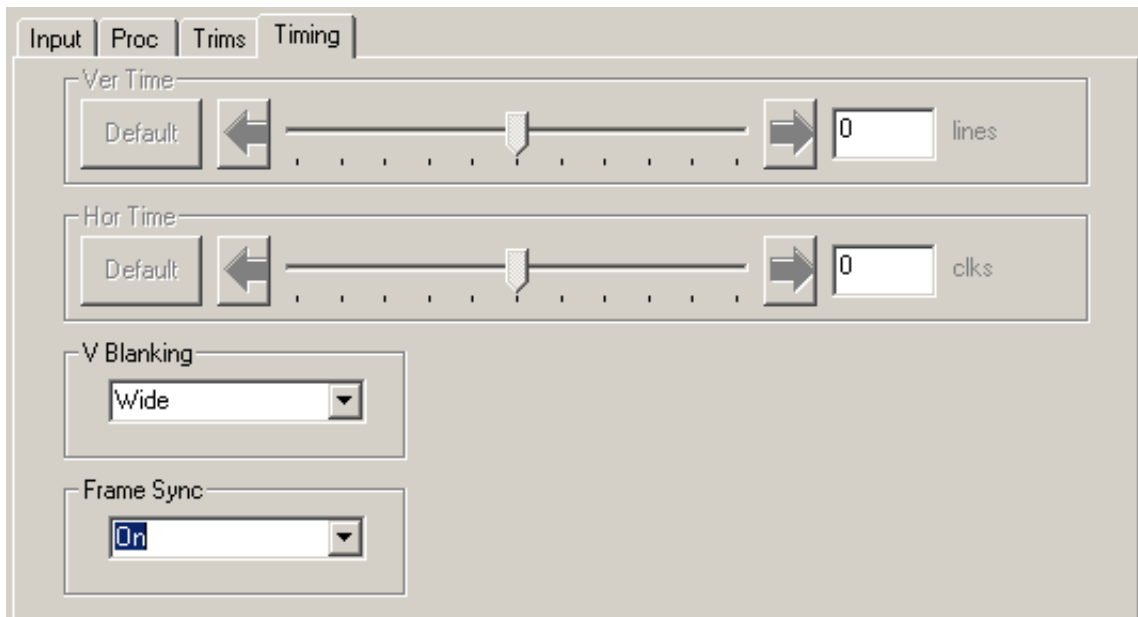

## WARRANTY AND FACTORY SERVICE

### Warranty

Ensemble Designs, Inc. warrants this product to be free from defect in material and workmanship for a period of five years from the date of delivery. During this two year warranty period, Ensemble Designs, Inc. will repair any defective units at Ensemble's expense if the unit should be determined to be defective after consultation with a factory technician.

This warranty is not transferable. Any implied warranties expire at the expiration date of this warranty.

This warranty does not cover a defect that has resulted from improper or unreasonable use or maintenance as determined by us. This warranty is void if there is any attempt to disassemble or adjust factory set presets without factory authorization.

### Factory Service

If you require service (under warranty or not), please contact Ensemble Designs and ask for Customer Service before you return the unit. This will allow the service technician to provide any other suggestions for identifying the problem and recommend possible solutions.

You may also refer to the technical support section of the Ensemble web site for the latest information on your equipment at the URL below:

<http://www.ensembledesigns.com/support>

If you return equipment for repair, please get a Return Material Authorization Number (RMA) from the factory first.

Ship the product and a written description of the problem to:

Ensemble Designs, Inc.

Attention: Customer Service RMA #####

870 Gold Flat Rd.

Nevada City, CA 95959 USA

(530) 478-1830

Fax: (530) 478-1832

[service@ensembledesigns.com](mailto:service@ensembledesigns.com)

<http://www.ensembledesigns.com>

Be sure to put your RMA number on the outside of the box.

## SPECIFICATIONS

### Analog Input:

Number: One  
Type: Beta/SMPTE, Y, Pr, Pb  
NTSC, PAL Composite  
NTSC, PAL S-Video  
Impedance: 75  $\Omega$   
Return Loss: > 40 dB  
Input DC: +/- 1 volt DC  
Input Hum: < 100 mV

### Serial Digital Output:

Number: One  
Type: 270Mb/s SD Serial digital  
(SMPTE 259M)  
Impedance: 75  $\Omega$   
Return Loss: > 15 dB  
Output DC: None (AC coupled)

### Analog to SDI Performance:

Bit Resolution: 12 bit input quantization  
4 X oversampling  
Signal to Noise: > 62 dB, weighted  
Frequency Response:  
Composite and Y  $\pm$  0.1 dB, 0 to 5.5 MHz  
Pr, Pb  $\pm$  0.1 dB, 0 to 2.75 MHz  
Minimum Delay: 90  $\mu$ Sec

### Reference Input:

Number: One  
Type: 1 V p-p Composite Video  
PAL or NTSC  
Impedance: 75  $\Omega$   
Return Loss: > 40 dB

### General Specifications:

Size: 5.625" W x 0.8 " H x 5.5" D  
(143 mm x 20 mm x 140 mm)  
including connectors  
Power: 12 volts, 7 watts  
Temperature Range: 0 to 40 degrees C ambient  
Relative Humidity: 0 to 95% noncondensing

Due to ongoing product development, all specifications are subject to change.

## **BRIGHTEYE POWER SUPPLY INFORMATION**

Below is a list of power supplies and optional items that may have come with your BrightEye:

### **BEPS**

BrightEye Individual Power Supply.

### **BEPS6**

Spider Power Supply. This powers 6 single high BrightEyes or 3 double high BrightEyes (BrightEye 90 family).

### **BEPS6-RP**

Redundant Power Supply for Spider.

### **BERKMT**

BrightEye Rack Mount. This holds 6 single high BrightEyes or 3 double high BrightEyes (BrightEye 90 family) or a combination.

### **BEBP**

BrightEye Blank Panel. Single high, for empty slots in Rack Mount.

### **BEAC**

Analog Audio Breakout Cable.

## GLOSSARY

This is a brief glossary of commonly used terms associated with this product.

### **AES/EBU**

The digital audio standard defined as a joint effort of the Audio Engineering Society and the European Broadcast Union. AES/EBU or AES3 describes a serial bitstream that carries two audio channels, thus an AES stream is a stereo pair. The AES/EBU standard covers a wide range of sample rates and quantizations (bit depths.) In television systems, these will generally be 48 KHz and either 20 or 24 bits.

### **Bandwidth**

Strictly speaking, this refers to the range of frequencies (i.e. the width of the band of frequency) used by a signal, or carried by a transmission channel. Generally, wider bandwidth will carry and reproduce a signal with greater fidelity and accuracy.

### **Beta**

Sony Beta SP video tape machines use an analog component format that is similar to SMPTE, but differs in the amplitude of the color difference signals. It may also carry setup on the luminance channel.

### **Blanking**

The Horizontal and Vertical blanking intervals of a television signal refer to the time periods between lines and between fields. No picture information is transmitted during these times, which are required in CRT displays to allow the electron beam to be repositioned for the start of the next line or field. They are also used to carry synchronizing pulses which are used in transmission and recovery of the image. Although some of these needs are disappearing, the intervals themselves are retained for compatibility purposes. They have turned out to be very useful for the transmission of additional content, such as teletext and embedded audio.

### **CAV**

Component Analog Video. This is a convenient shorthand form, but it is subject to confusion. It is sometimes used to mean ONLY color difference component formats (SMPTE or Beta), and other times to include RGB format. In any case, a CAV signal will always require 3 connectors – either Y/R-Y/B-Y, or R/G/B.

### **Checkfield**

A Checkfield signal is a special test signal that stresses particular aspects of serial digital transmission. The performance of the Phase Locked-Loops (PLLs) in an SDI receiver must be able to tolerate long runs of 0's and 1's. Under normal conditions, only very short runs of these are produced due to a scrambling algorithm that is used. The Checkfield, also referred to as the Pathological test signal, will “undo” the scrambling and cause extremely long runs to occur. This test signal is very useful for testing transmission paths.



## **Chroma**

The color or chroma content of a signal, consisting of the hue and saturation of the image. See also Color Difference.

## **Component**

In a component video system, the totality of the image is carried by three separate but related components. This method provides the best image fidelity with the fewest artifacts, but it requires three independent transmission paths (cables). The commonly used component formats are Luminance and Color Difference (Y/Pr/Pb), and RGB. It was far too unwieldy in the early days of color television to even consider component transmission.

## **Composite**

Composite television dates back to the early days of color transmission. This scheme encodes the color difference information onto a color subcarrier. The instantaneous phase of the subcarrier is the color's hue, and the amplitude is the color's saturation or intensity. This subcarrier is then added onto the existing luminance video signal. This trick works because the subcarrier is set at a high enough frequency to leave spectrum for the luminance information. But it is not a seamless matter to pull the signal apart again at the destination in order to display it or process it. The resultant artifacts of dot crawl (also referred to as chroma crawl) are only the most obvious result. Composite television is the most commonly used format throughout the world, either as PAL or NTSC. It is also referred to as Encoded video.

## **Color Difference**

Color Difference systems take advantage of the details of human vision. We have more acuity in our black and white vision than we do in color. This means that we need only the luminance information to be carried at full bandwidth, we can scrimp on the color channels. In order to do this, RGB information is converted to carry all of the luminance (Y is the black and white of the scene) in a single channel. The other two channels are used to carry the "color difference". Noted as B-Y and R-Y, these two signals describe how a particular pixel "differs" from being purely black and white. These channels typically have only half the bandwidth of the luminance.

## **Decibel (dB)**

The decibel is a unit of measure used to express the ratio in the amplitude or power of two signals. A difference of 20 dB corresponds to a 10:1 ratio between two signals, 6 dB is approximately a 2:1 ration. Decibels add while the ratios multiply, so 26 dB is a 20:1 ratio, and 14 dB is a 5:1 ratio. There are several special cases of the dB scale, where the reference is implied. Thus, dBm refers to power relative to 1 milliwatt, and dBu refers to voltage relative to .775V RMS. The original unit of measure was the Bel (10 times bigger), named after Alexander Graham Bell.

### **dBFS**

In Digital Audio systems, the largest numerical value that can be represented is referred to as Full Scale. No values or audio levels greater than FS can be reproduced because they would be clipped. The nominal operating point (roughly corresponding to 0 VU) must be set below FS in order to have headroom for audio peaks. This operating point is described relative to FS, so a digital reference level of -20 dBFS has 20 dB of headroom before hitting the FS clipping point.

### **EDH**

Error Detection and Handling is a method to verify proper reception of an SDI or HD-SDI signal at the destination. The originating device inserts a data packet in the vertical interval of the SDI signal and every line of the HD signal which contains a checksum of the entire video frame. This checksum is formed by adding up the numerical values of all of the samples in the frame, using a complex formula. At the destination this same formula is applied to the incoming video and the resulting value is compared to the one included in the transmission. If they match, then the content has all arrived with no errors. If they don't, then an error has occurred.

### **Embedded Audio**

Digital Audio can be carried along in the same bitstream as an SDI or HD-SDI signal by taking advantage of the gaps in the transmission which correspond to the horizontal and vertical intervals of the television waveform. This technique can be very cost effective in transmission and routing, but can also add complexity to signal handling issues because the audio content can no longer be treated independently of the video.

### **Frame Sync**

A Frame Synchronizer is used to synchronize the timing of a video signal to coincide with a timing reference (usually a color black signal that is distributed throughout a facility). The synchronizer accomplishes this by writing the incoming video into a frame buffer memory under the timing direction of the sync information contained in that video. Simultaneously the memory is being read back by a timing system that is genlocked to a house reference. As a result, the timing or alignment of the video frame can be adjusted so that the scan of the upper left corner of the image is happening simultaneously on all sources. This is a requirement for both analog and digital systems in order to perform video effects or switch glitch-free in a router. Frame synchronization can only be performed within a single television line standard. A synchronizer will not convert an NTSC signal to a PAL signal, it takes a standards converter to do that.

### **Frequency Response**

A measurement of the accuracy of a system to carry or reproduce a range of signal frequencies. Similar to Bandwidth.

## **IEC**

The International Electrotechnical Commission provides a wide range of worldwide standards. They have provided standardization of the AC power connection to products by means of an IEC line cord. The connection point uses three flat contact blades in a triangular arrangement, set in a rectangular connector. The IEC specification does not dictate line voltage or frequency. Therefore, the user must take care to verify that a device either has a universal input (capable of 90 to 230 volts, either 50 or 60 Hz), or that a line voltage switch, if present, is set correctly.

## **Interlace**

Human vision can be fooled to see motion by presenting a series of images, each with a small change relative to the previous image. In order to eliminate the flicker, our eyes need to see more than 30 images per second. This is accomplished in television systems by dividing the lines that make up each video frame (which run at 25 or 30 frames per second) into two fields. All of the odd-numbered lines are transmitted in the first field, the even-numbered lines are in the second field. In this way, the repetition rate is 50 or 60 Hz, without using more bandwidth. This trick has worked well for years, but it introduces other temporal artifacts. Motion pictures use a slightly different technique to raise the repetition rate from the original 24 frames that make up each second of film—they just project each one twice.

## **IRE**

Video level is measured on the IRE scale, where 0 IRE is black, and 100 IRE is full white. The actual voltages that these levels correspond to can vary between formats.

## **ITU-R 601**

This is the principal standard for standard definition component digital video. It defines the luminance and color difference coding system that is also referred to as 4:2:2. The standard applies to both PAL and NTSC derived signals. They both will result in an image that contains 720 pixels horizontally, with 486 vertical pixels in NTSC, and 576 vertically in PAL. Both systems use a sample clock rate of 27 Mhz, and are serialized at 270 Mb/s.

## **Jitter**

Serial digital signals (either video or audio) are subject to the effects of jitter. This refers to the instantaneous error that can occur from one bit to the next in the exact position each digital transition. Although the signal may be at the correct frequency on average, in the interim it varies. Some bits come slightly early, other come slightly late. The measurement of this jitter is given either as the amount of time uncertainty or as the fraction of a bit width. For 270 Mb/s video, the allowable jitter is 740 picoseconds, or 0.2 UI (Unit Interval – one bit width).

## **Luminance**

The “black & white” content of the image. Human vision had more acuity in luminance, so television systems generally devote more bandwidth to the luminance content. In component systems, the luminance is referred to as Y.

### **Multi-mode**

Multi-mode fibers have a larger diameter core (either 50 or 62.5 microns), and a correspondingly larger aperture. It is much easier to couple light energy into a multi-mode fiber, but internal reflections will cause multiple “modes” of the signal to propagate down the fiber. This will degrade the ability of the fiber to be used over long distances.

See also Single mode.

### **NTSC**

The color television encoding system used in North America was originally defined by the National Television Standards Committee. This American standard has also been adopted by Canada, Mexico, Japan, Korea, and Taiwan. (This standard is referred to disparagingly as Never Twice Same Color.)

### **Optical**

An optical interface between two devices carries data by modulating a light source. This light source is typically a laser or laser diode (similar to an LED) which is turned on and off at the bitrate of the datastream. The light is carried from one device to another through a glass fiber. The fiber’s core acts as a waveguide or lightpipe to carry the light energy from one end to another. Optical transmission has two very significant advantages over metallic copper cables. Firstly, it does not require that the two endpoint devices have any electrical connection to each other. This can be very advantageous in large facilities where problems with ground loops appear. And secondly, and most importantly, an optical interface can carry a signal for many kilometers or miles without any degradation or loss in the recovered signal. Copper is barely useful at distances of just 1000 feet.

### **Oversampling**

A technique to perform digital sampling at a multiple of the required sample rate. This has the advantage of raising the Nyquist Rate (the maximum frequency which can be reproduced by a given sample rate) much higher than the desired passband. this allows more easily realized anti-aliasing filters.

### **PAL**

During the early days of color television in North America, European broadcasters developed a competing system called Phase Alternation by Line. This slightly more complex system is better able to withstand the differential gain and phase errors that appear in amplifiers and transmission systems. Engineers at the BBC claim that it stands for Perfection At Last.

### **Progressive**

An image scanning technique which progresses through all of the lines in a frame in a single pass. Computer monitors all use progressive displays. This contrasts to the interlace technique common to television systems.

## **Return Loss**

An idealized input or output circuit will exactly match its desired impedance (generally 75 ohms) as a purely resistive element, with no reactive (capacitive or inductive elements). In the real world we can only approach the ideal. So our real inputs and outputs will have some capacitance and inductance. This will create impedance matching errors, especially at higher frequencies. The Return Loss of an input or output measures how much energy is returned (reflected back due to the impedance mismatch). For digital circuits, a return loss of 15 dB is typical. This means that the energy returned is 15 dB less than the original signal. In analog circuits, a 40 dB figure is expected.

## **RGB**

RGB systems carry the totality of the picture information as independent Red, Green, and Blue signals. Television is an additive color system, where all three components add to produce white. Because the luminance (or detail) information is carried partially in each of the RGB channels, all three must be carried at full bandwidth in order to faithfully reproduce an image.

## **ScH Phase**

Used in composite systems, ScH Phase measures the relative phase between the leading edge of sync on line 1 of field 1 and a continuous subcarrier sinewave. Due to the arithmetic details of both PAL and NTSC, this relationship is not the same at the beginning of each frame. In PAL, the pattern repeats ever 4 frames (8 fields) which is also known as the Bruch Blanking sequence. In NTSC, the repeat is every 2 frames (4 fields). This creates enormous headaches in editing systems and the system timing of analog composite facilities.

## **SDI**

Serial Digital Interface. This term refers to inputs and outputs of devices that support serial digital component video. This generally means standard definition at 270 Mb/s. The use of “HD-SDI” is beginning to appear to indicate High Definition Serial Digital video at 1.485 Gb/s.

## **SMPTE**

The Society of Motion Picture and Television Engineers is a professional organization which has done tremendous work in setting standards for both the film and television industries. The term “SMPTE” is also shorthand for one particular component video format - luminance and color difference.

## **Single Mode**

A Single mode (or monomode) optical fiber carries an optical signal on a very small diameter (9 micron) core surrounded with cladding. The small diameter means that no internally reflected lightwaves will be propagated. Thus only the original “mode” of the signal passes down the fiber. A single mode fiber used in an optical SDI system can carry a signal for up to 20 kilometers. Single mode fibers require particular care in their installation due to the extremely small optical aperture that they present at splice and connection points.

See also Multi-mode.

## **TBC**

A Time Base Corrector is a system to reduce the Time Base Error in a signal to acceptable levels. It accomplishes this by using a FIFO (First In, First Out) memory. The incoming video is written into the memory using its own jittery timing. This operation is closely associated with the actual digitization of the analog signal because the varying position of the sync timing must be mimicked by the sampling function of the analog to digital converter. A second timing system, genlocked to a stable reference, is used to read the video back out of the memory. The memory acts as a dynamically adjusting delay to smooth out the imperfections in the original signal's timing. Very often a TBC will also function as a Frame Synchronizer.

See also: Frame Sync.

## **Time Base Error**

Time base error is present when there is excessive jitter or uncertainty in the line to line output timing of a video signal. This is commonly associated with playback from video tape recorders, and is particularly severe with consumer type heterodyne systems like VHS. Time base error will render a signal unusable for broadcast or editing purposes.

## **Tri Level Sync**

An analog sync reference signal that is used in High Definition systems. Tri Level Sync is constructed with three signal levels, the sync pulses extend above and below a mid-level average voltage (the blanking level). Unlike conventional analog sync which is bi-level, the proper 50% pickoff point is already identified in Tri Level Sync. This contributes to lower jitter in digital systems.

## **YUV**

Strictly speaking, YUV does not apply to component video. The letters refer to the Luminance (Y), and the U and V encoding axes using in the PAL composite system. Since the U axis is very close to the B-Y axis, and the V axis is very close to the R-Y axis, YUV is often used as a sort of shorthand for the more long-winded "Y/R-Y/B-Y".

## **Y/Cr/Cb**

In digital component video, the luminance component is Y, and the two color difference signals are Cr (R-Y) and Cb (B-Y).

## **Y/Pr/Pb**

In analog component video, the image is carried in three components. The luminance is Y, the R-Y color difference signal is Pr, and the B-Y color difference signal is Pb.