

JIB/PA50

USER'S MANUAL



JACKS in the BOX

COMPACT POWER AMPLIFIER

25W X 2

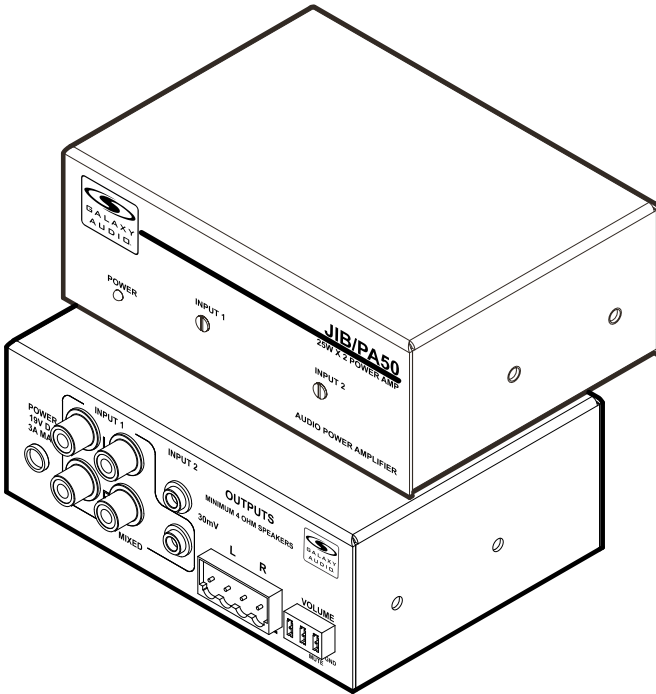

MAKERS OF THE ORIGINAL
HOT SPOT PERSONAL MONITOR

Contents

System Components.....	1
Warning Statements.....	1
Features.....	2
Installing the Compact Power Amplifier.....	3-4
Wiring.....	3-4
Setup.....	3-4
Input 1 Control and Volume Setup.....	5
Input 2 Control Setup.....	6
Technical Specifications.....	6

Introduction

Thank you for choosing the Galaxy Audio JIB/PA50 Compact Power Amplifier. You have joined the hundreds of thousands of other satisfied Galaxy customers. Since 1977 Galaxy Audio's professional experience in design and manufacturing ensure our products' quality, performance and reliability.

System Components

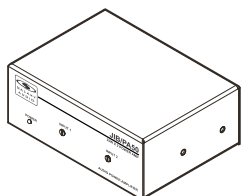

1 JIB/PA50



Manual



1 DC Power Supply
(PS-19-3.45.5)



1 4-Pin Captive
Screw Plug
(CN-4SP)



1 3-Pin Captive
Screw Plug
(CN-3SP)



4 Rubber Feet
(HRF)

Warning Statements



Prior to the installation of this product, these installation instructions must be read and completely understood. Keep these instructions for future reference.



Proper installation procedure by a qualified service technician must be followed, as outlined in these installation instructions. Failure to do so could result in property damage, serious personal injury, or even death.



Galaxy Audio does not warrant against damage caused by the use of any Galaxy Audio product for purposes other than those for which it was designed or damage caused by unauthorized attachments or modifications, and is not responsible for any damages, claims, demands, suits, actions or causes of action of whatever kind resulting from, arising out of or in any manner relating to any such use, attachments or modifications.

For the most up to date manual and information visit www.galaxyaudio.com.

The JIB/PA50 Compact Power Amplifier is an energy-efficient, 50amp Energy Star rated® Class-D amplifier and is perfect for the classroom or meeting room environment.

Automatic Standby

Standby mode activates if no input signal is detected for 20 minutes. Once an input signal is detected the unit resumes normal function.

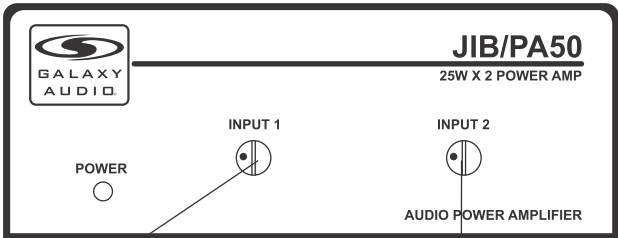

Front View

Input 1
Use the Input 1 potentiometer on the front panel to control the gain.

Input 2
Use the Input 2 potentiometer on the front panel to control the gain on the input 2 signal.

Input 2
The mono sound will be evenly mixed into the left and right amp channels.

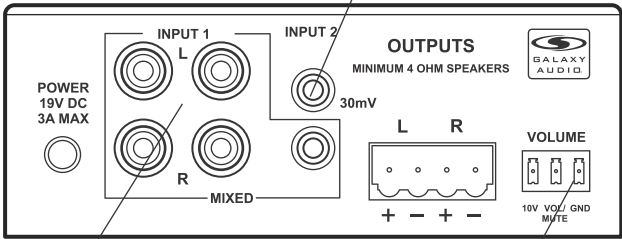

Back View

Input Mixing
The JIB/PA50 has two line-level stereo inputs on RCA connectors plus one line-level stereo input on a 3.5mm mini-jack and one sub-line level (30 mV) mono input on a TRS (3.5mm) mini-jack. Input switching is not needed. All signals are mixed inside the amp at a 1:1:1 ratio.

External Volume Control
You can plug in an optional 10k volume pot. The external volume control only adjusts the mixed Input 1 signals, not the Input 2 signal.

Installing the Compact Power Amplifier

Wiring Step 1



If you are connecting the sound sources directly to the projector, follow the suggested Option A wiring diagram (Figure 1) for reference.

If you are connecting the sound sources directly to the JIB/PA50 Power Amp and are using the external volume control, follow the suggested Option B wiring diagram (Figure 2) and 10k Pot Volume Wiring Diagram (Figure 3) for reference.

Figure 1

OPTION A

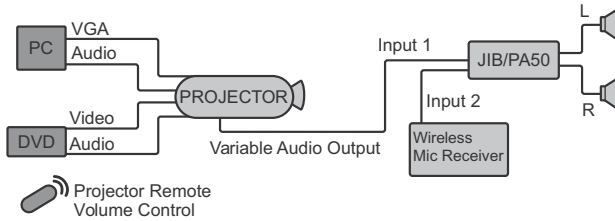

Figure 2

OPTION B

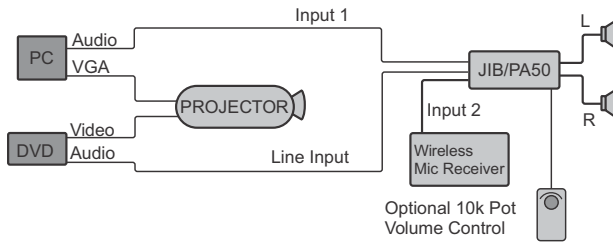
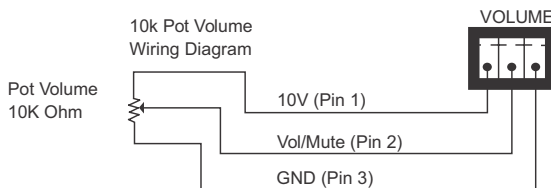



Figure 3



Installing the Compact Power Amplifier

Step 2

1. Use standard RCA connectors and/or 1/8" (3.5mm) mini-cables to connect the input devices (e.g., the projector, other audio sources) to the power amp.

 Match the wiring polarity. For example, red for positive, black or white for negative.

 Make sure no wire strand bridges (shorts) the adjacent terminals.

2. Insert all four wires on each speaker into the blue 4-pin captive screw plug supplied with the power amp.

 Use a #1 Phillips screwdriver to tighten the locking screws.

3. Insert the captive screw plug into the receptacle on the amp's rear panel (see drawing).

4. Attach the power amp plug to the amplifier.

 Do you need to wire the 10k pot volume? If Yes, proceed to Step 3 below

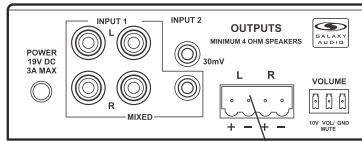

Amp Receptacle for the Blue 4-Pin Captive Screw Plug

Step 3

 When wiring the 10V, Vol/Mute and GND outputs, strip off the insulation from the external volume control wire by 3/16". Make sure the wire ends do not touch. Keep exposed wire ends short after stripping. If the wires touch, they may short the amp.

1. Follow the 10k Pot Volume Wiring Diagram to connect the external volume control to the amp (Figure 4).

2. Insert all three pins from the external volume control into the green 3-pin captive screw plug supplied with the amp (see drawing).

Use a #1 flat blade screwdriver to tighten the locking screws.

3. Insert the captive screw plug into the receptacle on the amp's rear panel (Figure 5).

Figure 4

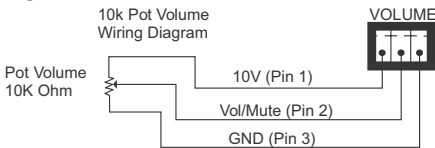
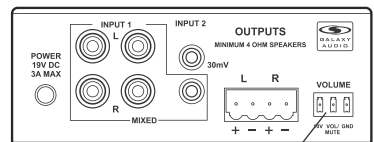

Figure 5



Amp Receptacle for the Green 3-Pin Captive Screw Plug

Input 1 Control and Volume Setup

Figure 6

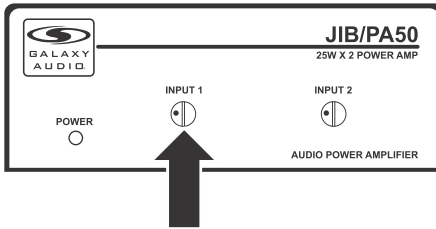

? If you are using the Option A wiring method of installation on page 3, do the following:

1. Insert a #1 flat blade screwdriver to the **Input 1** control.
2. To test the volume, use the screwdriver to gently turn the **Input 1** control on the amp counter-clockwise to the end (Figure 6).
3. Turn **Input 1** control clockwise 1/4 turn.
4. Play sound from the loudest audio source input on the projector to help adjust the amp volume.
5. Turn the **Input 1** control on the amp clockwise slowly until the sound distorts.
6. Turn the **Input 1** control counter-clockwise until the distortion disappears.
7. Adjust the projector volume until you reach the desired sound level.

? If you are using the Option B wiring method of installation on page 3, do the following:

1. Insert a #1 flat blade screwdriver to the **Input 1** control.
2. To test the volume, use the screwdriver to gently turn the **Input 1** control on the amp counter-clockwise to the end (Figure 6).
3. Turn the **Input 1** control clockwise 1/4 turn.
4. Turn the 10k pot volume to the maximum level.
5. Play sound through all the audio inputs on the amp.
6. Choose the loudest audio source to help adjust the amp volume.
7. Turn the **Input 1** control on the amp clockwise slowly until the sound distorts.
8. Turn the **Input 1** control counter-clockwise until the distortion disappears.
9. Adjust the 10k pot volume until you reach the desired sound level.

After setting up the **Input 1**, let the sound continue to play and proceed to the “**Input 2 Setup**” section on page 6.

Input 2 Control Setup

Figure 7

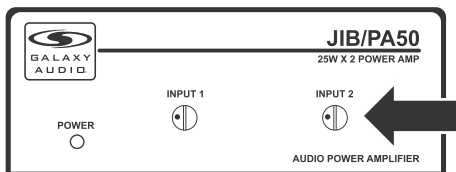

1. Attach a device such as a wireless microphone to the amp input.



Be sure the mic is turned on.

2. Insert a #1 flat blade screwdriver to the **Input 2** control.
3. Use the screwdriver to gently turn the **Input 2** control on the amp counterclockwise to the end (Figure 7).
4. Turn on the mic receiver, if applicable.
5. Have someone stand in the desired presentation location and speak into the mic.
6. Turn the Input 2 control clockwise until you reach the desired sound level.

7. Test feedback by having someone walk around the room and speak into the mic.



Is there feedback coming from the mic?

If Yes, turn the **Input 2** control counterclockwise until the feedback is gone.

If No, continue to step 8.

8. Play music through the amp as you test the mic.



Is the music too loud compared to the voice on the mic?

If Yes, turn the **Input 1** control counterclockwise until you reach the desired sound balance.

If No, you have finished installation.

Technical Specifications

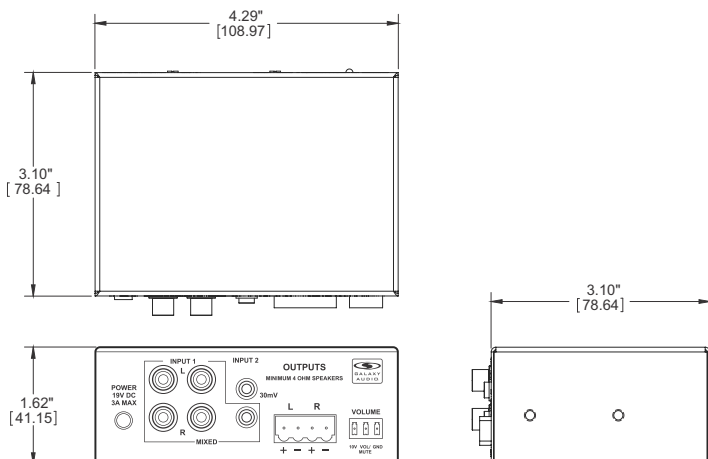



MAKERS OF THE ORIGINAL
HOT SPOT PERSONAL MONITOR



www.galaxyaudio.com

THREE YEAR LIMITED WARRANTY

WARRANTY Information can be viewed online at
<http://www.galaxyaudio.com/warranty.php>



www.galaxyaudio.com/warranty.php

JIB/PA50

USER'S MANUAL

Specifications in this manual are subject to change without notice.
For the most up to date manual and information
visit www.galaxyaudio.com.

1-800-369-7768 www.galaxyaudio.com

© Copyright Galaxy Audio 2013

Printed in Taiwan

V08122013