

ANY SPOT[®] TRAVELER[®]

Wireless Portable Sound Systems

TV10, TV8, TV5i & TV5X

Plus TXRM Stationary Transmitter

USER'S GUIDE



**ALL INCLUSIVE BATTERY
OPERATED PORTABLE PA SYSTEM
COMPACT, LIGHTWEIGHT, HIGH OUTPUT POWER &
CLEAR SOUND.**



MAKERS OF THE ORIGINAL
HOT SPOT PERSONAL MONITOR





Contents

Introduction	1
Before using the TV10, TV8, TV5i & TV5X.....	2
TV10 & TV8 Series Description of Functions.....	2
TV10 Front & Rear Panel Configuration & Master Control Panel.....	3
Guide for TV10 Bluetooth® Connection/TV8 Rear Panel Configuration.....	4
TV8 Master Control/Operation of the TV10 & TV8 Portable Sound System.....	5
TV10 & TV8 Series Optional Modules	6-8
Audio Link Transmitter (AS-TVTX).....	6
Wireless Mic/Audio Link Receiver	6
TV-DREC/TV5-DREC Dual Receiver Module.....	7
Bluetooth® Receiver Module.....	7
RM-CD CD/MP3/SD/USB Player.....	8
RM-CDV CD/DVD/MP3/SD/USB Player.....	8
RM-DIGIMP Digital Player.....	8
TV5i & TV5X	9-12
TV5i Front & Rear Panel.....	9
TV5X Panel Configuration.....	10
Bluetooth® Connection.....	11
TV5MP3 Optional Media Player.....	11
Wireless Microphone Receiver Option TV5-REC for TV5i & TV5X.....	12
WIRELESS TRAVELER TRANSMITTERS & RECEIVER	13-21
TVHH Microphone Description & Functions.....	14, 15
TVH2 Microphone Description & Functions.....	16, 17
TVBPT Body Pack Transmitter Description & Functions.....	17
TVMBP Body Pack Transmitter Description & Functions.....	18, 19
Maintenance.....	19
AS-TXRM Stationary Transmitter.....	20
Setup and Operation of AS-TXRM.....	20
AS-TVBP Body Pack Receiver Description & Functions.....	21
Traveler Accessories and Parts	22-25
Optional Traveler Accessories.....	22-23
Replaceable Traveler Parts.....	24-25
Specifications	26-31
TV10 Specifications.....	26
TV8 Specifications.....	27
TV5i Specifications.....	28
TV5X Specifications.....	29
TV-REC Wireless Receiver Module.....	30
TV-DREC/TV5-DREC Wireless Receiver Module.....	31
AS-TVTX & AS-TXRM Audio Link Transmitter Module.....	32
TVHH Handheld Microphones.....	32
TVH2 Handheld Microphones.....	33
TVMBP Body Pack Transmitter.....	33
TVBPT Body Pack Transmitter.....	34
TV5MP3 Digital Media Player.....	34
AS-TVBP Body Pack Receiver.....	35
TRAVELER APPLICATION TABLE	36
BATTERY REPLACEMENT INSTRUCTIONS FOR THE TRAVELER	37

Introduction

Operating Manual for TV10/TV8/TV5i/TV5X Series

Please visit www.galaxyaudio.com for the latest updates

Thank you for purchasing the TV10/TV8/TV5i/TV5X series wireless portable sound systems. These units feature an “all in one” design that allows them to be configured with a variety of different function modules to suit your specific needs. With rich, full sound and plenty of power, the TV10/TV8 series is ideally suited to cover large areas. The TV5's, with their compact size, is ideal for classrooms, conference rooms, and guided tours. This manual covers the complete functions and operations of the TV10/TV8, TV5i and TV5X including all optional function modules. It also covers the AS-TXRM Stationary Transmitter, the TVHH & TVH2 Handheld Wireless Mics, the TVMBP Body Pack & TVBPT Pendant Transmitters and the AS-TVBP Body Pack Receiver. To use these systems to their fullest potential please read this manual carefully.

Before Using the TV10, TV8, TV5i & TV5X

Before Using the TV10, TV8, TV5i & TV5X

1. The TV10 and TV8 use a universal AC switching power supply/charger that will operate on voltages of 100~240V, 50/60Hz. The TV10, TV8 power supplies are internal, while both of the TV5's are external. Verify that the voltage to which you are connecting is in this range and then connect the AC power cord from the Traveler to the wall outlet.
2. **Charge the battery for at least 8 hours with the Power Switch OFF prior to first time use** to maintain the quality of the battery and provide maximum operation time. When charging, the charging indicator lights RED. When charging is almost complete, the indicator will flash alternately RED and GREEN. After the battery is fully charged, the indicator will light GREEN. After the initial charge the Traveler may be operated on either AC or Battery power. When operating on AC power the Traveler will simultaneously recharge its internal batteries.
3. These units have auto protection circuitry that will protect the battery from being overcharged or overused. When running on battery power and the power switch LED blinks RED, the battery power is down to 30%. When the battery is nearly exhausted, the system will turn off automatically to protect the battery.



TV8

CHARGING FUNCTIONS:

1. Charge indicator will illuminate red when charging and green when fully charged
2. Unit can be permanently left on charge.
3. For maximum battery life, recharge after every use and at least once every 3 months.
4. When in use and battery capacity is < 20% the power switch flashes red.

TV10

CHARGING FUNCTIONS:

1. Charge indicator will light appropriately to the amount of charge left. (20%, 50%, 80% & FULL)
2. Unit can be permanently left on charge.
3. For maximum battery life, recharge after every use and at least once every 3 months.
4. When in use and battery capacity is < 20% the power switch flashes red.

TV5i & TV5X

CHARGING FUNCTIONS:

- Charging- LEDs light in sequence.
- Fully charged-Only top Green LED will light.

USEFUL TIPS:

- Unit can be permanently left on charge.
- For maximum battery life, recharge after every use and at least once every 3 months.

Description of Functions for TV8 & TV10

A. Power Supply/Charging Input

1. AC Power Cable connector
2. Batteries (behind cover)
3. Battery cover

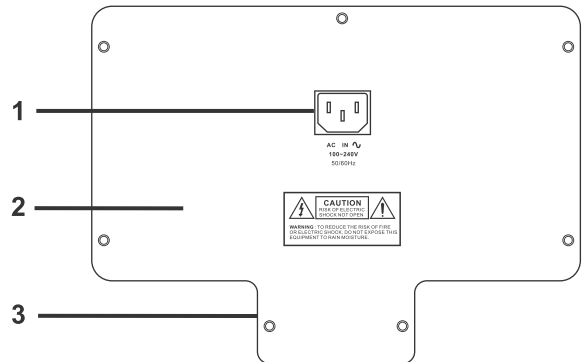

B. Power Switch and Charge Indicator for TV10

1. Power LED
2. Charging indicator
3. Power On/Off switch

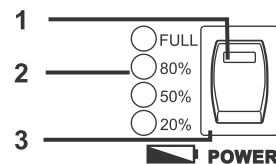

C. Power Switch and Charge Indicator for TV8

1. Power LED
2. Charging indicator
3. Power On/Off switch

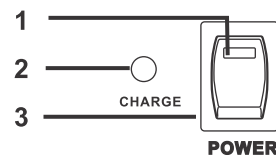

TV10 Front & Rear Panel Configuration



Front Side

1. Retractable Handle
2. Handle
3. Horn Tweeter
4. Speaker Grille
5. Woofer
6. Port
7. Wheels

TV10 Series Rear Panel Configuration

TV10-JT210000K9 (Part# for unit shown with options)



Rear Side

1. Retractable Handle
2. Optional Wireless Receivers
3. Optional CD/MP3 Player
4. Main Power Switch and Charging Indicator (Optional Transmitter module)
5. Master Control Panel
6. AC Power Input
7. Battery Cover
8. Wheels

C. TV10 Master Control Panel

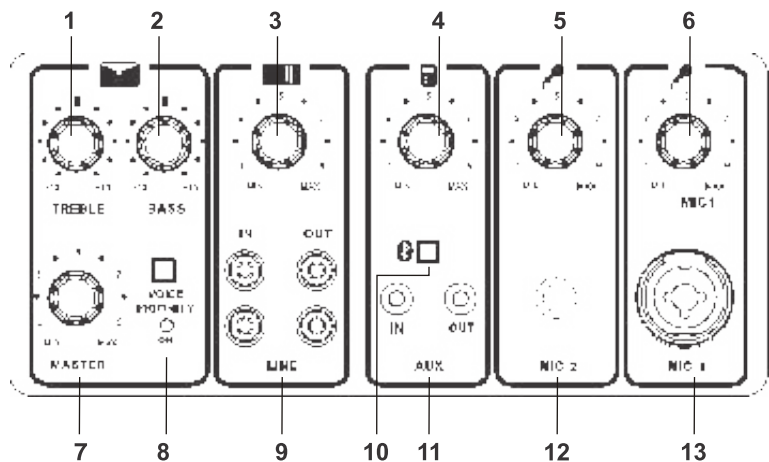

1. TREBLE control
2. BASS control
3. LINE IN volume control
4. AUX IN Bluetooth® volume control
5. MIC2 volume control
6. MIC1 volume control
7. MASTER control for overall system volume
8. VOICE PRIORITY button to activate or end the microphone priority function
LED lights red meaning the voice priority function is active.
9. LINE-IN (RCA phone jack) to connect with external music sources including CD/MP3/DVD/iPod players etc.
LINE OUT (RCA phone jack) to connect with external mixed-signal recorder or active speaker system
10. BLUETOOTH® Button
11. AUX IN (1/8" jack) to connect with external music sources including CD/MP3/DVD/iPod players etc.
AUX OUT (1/8" jack) to connect with external mixed-signal recorder or active speaker system
12. MIC IN 2 (1/4" jack) microphone connector
13. MIC IN 1 (XLR / 1/4" jack) combo microphone connector

Guide for TV10 Bluetooth® Connection

Turn On and Off:

Press and hold Bluetooth® button for approximately 2 seconds to activate the Bluetooth® function. Press and hold Bluetooth® button for approximately 2 seconds again, to turn the Bluetooth® function off.

Bluetooth® Pairing:

1. When Bluetooth® function is activated successfully, it will emit with a prompt tone.
2. The button will flash Blue as a sign that the device is in pairing mode.
3. Activate the Bluetooth® connection on your smartphone or any Bluetooth® device you are using.
4. Find the device name “Galaxy Traveler” on the pairing list to connect your device.
5. When the pairing is successful, it will emit a prompt tone again and the blue indicator light will be illuminated.
6. You are ready to stream audio from your device.

Caution:

1. During Bluetooth® connection, audio playback will stop when a call is made to your smartphone or tablet. When the call is finished, Bluetooth® will be relinked automatically and audio files will be played.
2. The Bluetooth® connection can be lost when the device gets out of range of the TV10. When this happens it may automatically re-link when back in range, or it may have to be manually reset. This is dependant on the device and it's operating system. Typical range is $\leq 30'$.

TV8 Rear Panel Configuration

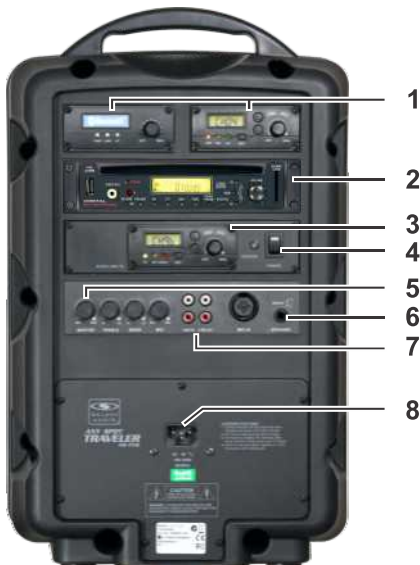

TV8 Series Rear Panel Configuration

TV8-JT310000K9 (Part# for unit shown with options)

1. Optional Receiver Modules
2. Optional Media Player
3. Audio Link Transmitter
4. Power Switch
5. Mixer
6. Speaker Out
7. In/Out Jacks
8. Power Supply/Charging Input

D. TV8 Master Control Panel

- | | |
|------------------------------------------------------------------------|-----------------------------------------------------------------|
| 1. Master volume control | 5. Line in RCA jacks |
| 2. Treble control | 6. Line out RCA jacks |
| 3. Bass control | 7. Mic in XLR/1/4" jack |
| 4. Mic volume control
(For wired Mic connected
to Mic In jack 7) | 8. Speaker level output jack.
Minimum 8 ohm external speaker |

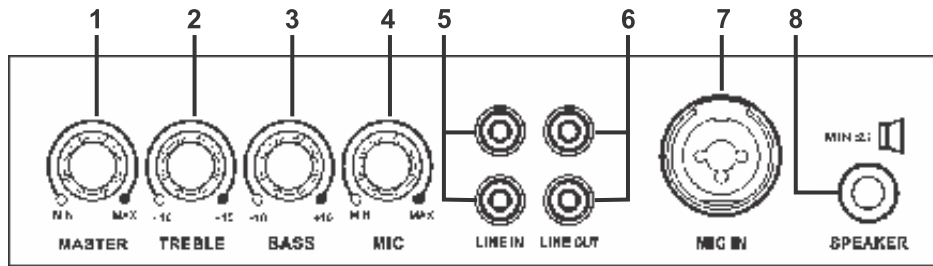

D. TV8 Master Control Panel

1. Master Volume Control.
2. Turn the Treble control (**D-2**) counterclockwise to decrease the treble, and turn clockwise to increase the treble. The center position (straight up) produces a flat response.
3. Turn the Bass control (**D-3**) counterclockwise to decrease the bass, and turn clockwise to increase the bass. The center position (straight up) produces a flat response.
4. Mic Volume (**D-3**) for wired Mic In jack (**D-7**).
5. The system contains Line In, Line Out, and Mic in jacks for connecting external audio devices.
6. Line In (**D-5**): RCA jacks to connect external audio sources, such as CD/MP3 players or iPods. The volume of the Line In is controlled solely by the Master (**D-5**) on the TV8, and by the Line In on the TV10.
7. Line Out (**D-6**): RCA jacks for sending the entire mix signal to other audio devices, such as recorders, mixers, or power amps.
8. Mic In (**D-7**): XLR or 1/4" (6.3mm) phone jack for wired microphones. Volume of this input is controlled by Mic In (**D-4**) and the Master (**D-1**).
9. **Speaker Out: (D-8)** Used to connect to an external unpowered speaker (8Ω Min.) **TV8 Only**

Operation of the TV10 & TV8 Portable Sound System

A. Power Supply/Charger (see page 2)

1. There is a universal AC switching power supply/charger built into the system that will operate on voltages of 100~240V, 50/60Hz. Verify that the voltage to which you are connecting is in that range and then connect the AC power cord from the AC IN (**A1**) to the wall outlet.

B. Power Switch and Charge Indicator (see page 2)

1. Power LED lights constant red under normal operation when power switch is on. Blinking Power LED indicates <20% of battery power remaining.
2. **TV8:** When charging is almost complete, the indicator will flash RED and GREEN. After the battery is fully charged, the indicator lights GREEN.
TV10: When charging, the LED lights will light up appropriately to the charge amount of 20%, 50%, 80% and FULL.

The Universal Power Supply/Battery Charger allows the Traveler to be used anywhere in the world. The Traveler will operate for an unlimited time on AC power and for about 6 hours on just battery power. A full recharge of the batteries takes about 4 hours. The Traveler may be operated while recharging the batteries without affecting the charge time. If a power failure occurs when operating on AC, the Traveler will seamlessly switch over to battery power.

Optional Modules for TRAVELERS

E. Audio Link Transmitter (AS-TVTX) (for TV8/TV10)

1. LCD display
2. TX indicator
3. Low audio level indicator
4. High audio level indicator
5. Enter Setting
6. Channel selector
7. Power switch and volume control

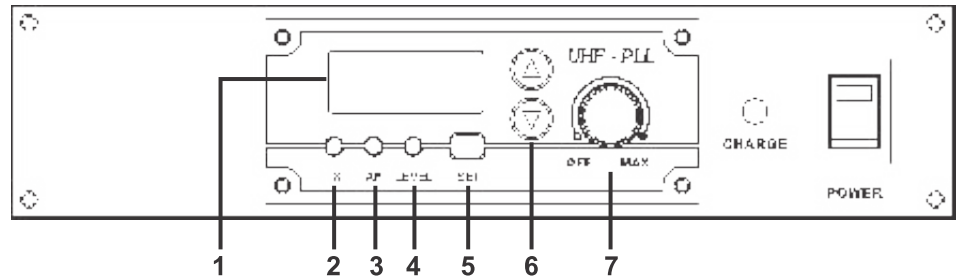

► This module transmits the entire audio mix from one Traveler to another Traveler that is equipped with a wireless Mic/Audio Link Receiver.

1. Turn the volume control (E-7) clockwise to turn on the transmitter.
2. The LCD display (E-1) will show "On" and the channel in use when the unit was last turned off.
3. To select a different channel, press the set button (E-5) and the channel will flash in the LCD display. Press the up or down button (E-6) to select the transmit channel, and then press the set button again to enter the setting. The LCD will then automatically display the selected channel. To display the frequency of the selected channel press and hold either the up or down button.
4. Turn the volume control (E-7) to adjust the audio transmit level. Use this control in conjunction with the volume controls on the receiving Traveler.
5. When transmitting signal, the TX indicator (E-2) will light Green to show the transmitting condition. The AF Level indicator lights Yellow (E-3) to show a low audio level and lights Red (E-4) to show high audio level.
6. Set up the receiving Traveler according to the procedure outlined in: section (F) page 6. Wireless Mic/Audio Link Receiver Select the same channel chosen on the transmitting Traveler.

F. Wireless Microphone/Audio Link Receiver (TV-REC for TV8/TV10) & (TV5-REC for TV5i/TV5X)

1. LCD display
2. A/B diversity indicator
3. RF indicator
4. AF level indicator
5. Channel Sync
6. Channel selector
7. Power switch & mic. volume

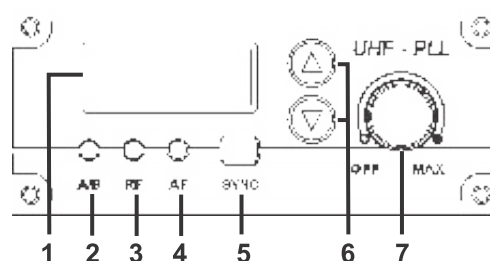

F. Wireless Mic/Audio Link Receiver (TV-REC)

This system may include one or two receivers with selectable PLL 96 channel operation. These modules receive signals from wireless Mics or from another Traveler equipped with an Audio Link Transmitter.

1. Turn the volume control (F-7) clockwise to turn on the receiver.
2. The LCD display (F-1) will show "On" and the channel that was last in use when the unit was turned off.
3. To select a different channel, press the sync (F-5) button. The channel number will flash in the LCD display (F-1). Press the up or down (F-6) button to select a channel to use, and then press the sync (F-5) button. After a channel has been synced, press either the up or down (F-6) button to display the frequency of the selected channel.
4. Adjust the volume control (F-7) to the desired level.
5. When receiving signal, the A/B diversity indicator (F-2) will light RED (A) or GREEN (B) to show the normal condition. The RF indicator (F-3) will light to show RF received and the AF indicator (F-4) will show audio received.

TV5-REC Wireless Mic/Audio Receiver on Page 11.

G. Dual Receiver (TV-DREC for TV8/TV10) & (TV5-DREC for TV5i/TV5X)

1. LCD display
2. Channel A Power and Volume Control
3. Channel Select
4. Channel Set
5. Channel B Power and Volume Control

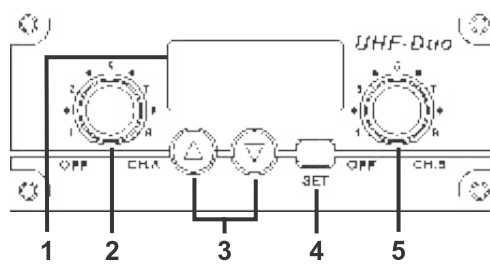

G. Dual Receiver (TV-DREC/TV5-DREC)

This system will allow you to use two wireless microphones with one receiver card. With Dual Volume controls, you can set the wireless microphones with 96 selectable frequencies each.

1. Turn the volume control (**G-2 and G-5**) clockwise for each channel to turn on the receivers.
2. The LCD display (**G-1**) will display “ON” for a moment then will display the frequency channel number each channel A and B, are currently assigned.
3. To select a different channel, press and hold the set (**G-4**) button until the channel number in channel A begins to flash. Use the up and down arrow (**G-3**) buttons to reach the desired channel, press the Set (**G-4**) button again and it will lock in channel A, and channel B will begin to flash. Again use the up and down arrow (**G-3**) buttons to reach the desired channel, press the set (**G-4**) button again and it will lock in channel B.
4. When receiving signal a signal strength meter will appear above the channel letter A or B.
5. To check the frequency of a channel, press the up arrow (**G-3**) for channel A, and down arrow (**G-3**) for channel B.

H. Bluetooth® Receiver Module

(TV-RECBT for TV8/TV10)
(TV5-RECBT for TV5i & TV5X)

1. PWR - Power indicator
2. LINK - Bluetooth® connectivity indicator
3. AF - Audio Frequency indicator
4. On/Off/Volume control knob

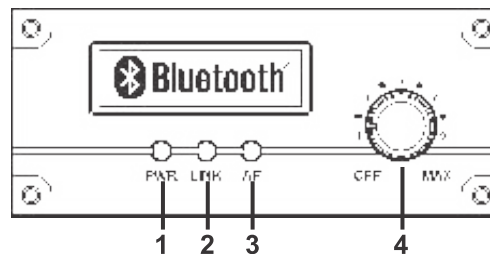

1. Turn the volume control (**H-4**) clockwise to switch on the Bluetooth® module. Set a mid-range volume level to begin.
2. You will hear a tone and the PWR indicator LED (**H-1**) will light blue. The LINK indicator (**H-2**) will also flash blue to indicate that the module is ready to pair with another Bluetooth® device.
3. When in pairing mode, activate a Bluetooth® connection scan on your device that will serve as a source of audio. When the search is complete, select a device named “Galaxy Traveler” from the pairing list. Your device will attempt to connect with the Bluetooth® module.
4. When the devices have successfully paired, the module will sound a prompt tone again. The LINK indicator (**H-2**) will light steady blue.
5. You are now ready to stream audio via the Bluetooth® connection from your device. You can adjust the audio volume on your device or using the volume knob (**H-4**) on the Bluetooth® receiver module.
6. The AF indicator (**H-3**) will light when an audio signal is streamed from your playback device and received by the Bluetooth® module.
7. If a phone call is incoming during playback, the audio stream will be interrupted for the user to take the call. When the call is finished, the Bluetooth® module will automatically re-link and audio files will continue playback from where they were interrupted.
8. When a user moves out of range for the Bluetooth® connection, the audio stream will be severed until the user returns to a location within range of the module. The range is approximately 30 feet. However, it depends on the operating system that’s installed on the device. Occasionally it’s necessary to manually reconnect to the Bluetooth® following the steps above.

Optional Modules for TV10/TV8 / RM-CD / RM-CDV / RM-DIGIMP

Optional Modules for TV10/TV8

I. RM-CD CD/MP3/SD/USB Player w/Remote **OPTION C**

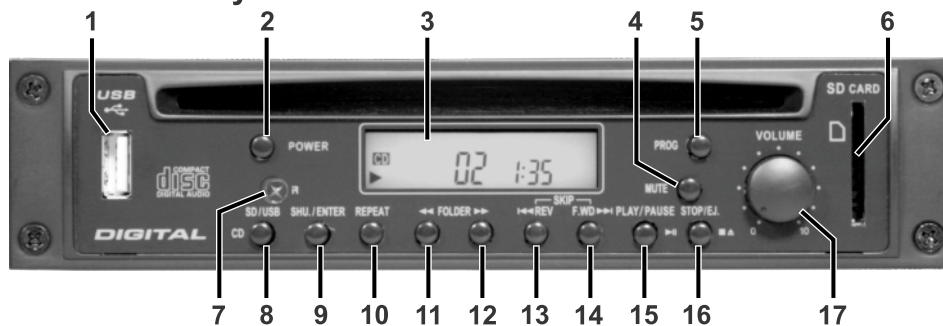

- | | |
|-----------------------------------------------------------------------------------------------------------------------------------------------------------------------------------------------------------------------------------------------------------------------------------------------------------------------------------------|--------------------------------------------------------------------------------------------------------------------------------------------------------------------------------------------------------------------------------------------------------------------------------------------------------|
| <ul style="list-style-type: none"> 1. USB Connector 2. Power Switch 3. LCD display 4. Mute 5. Program Button 6. SD Card Slot: Accepts SD and SDHC Cards containing MP3 files 7. IR Window 8. CD / USB / SD: Press this key to select USB, SD, or CD mode. | <ul style="list-style-type: none"> 9. Shuffle and execute button 10. Repeat: Repeat play mode 11. Previous Folder 12. Next Folder 13. Reverse 14. Fast Forward 15. Play/Pause 16. Stop/Eject 17. Volume Control |
|-----------------------------------------------------------------------------------------------------------------------------------------------------------------------------------------------------------------------------------------------------------------------------------------------------------------------------------------|--------------------------------------------------------------------------------------------------------------------------------------------------------------------------------------------------------------------------------------------------------------------------------------------------------|

1. Push the power switch (I-2) to turn on the player. Put a CD in the CD slot (I-10) or push the Stop/Eject button (I-5) to take a CD out of the slot.
2. Press the Play/Pause button (I-8) to start or pause CD/MP3 play. Turn the volume control (I-9) to adjust to the proper volume. Push the Stop/Eject button to stop or change the CD or MP3 disc.
3. Press the Forward (I-7) or Reverse (I-6) button to skip forward to the next rack or reverse to the previous track. Holding down the Forward or Reverse button will continuously forward or reverse the tracks.

Tip: MP3 files on a USB or Flash card should be loaded on the media in the order of desired playback. Do not have files in individual folders.

4. Repeat/Shuffle (I-4) has three modes:

1. Repeat one song
2. Repeat all songs
3. Shuffle for random play.

5. Create Program Playlist:

Step 1: Press Prog button (I-1) to begin setting up the program playlist

Step 2: Select a song (see step 3 and 6)

Step 3: Press Repeat (I-4) to enter the song. Repeat steps 2 and 3 to enter additional songs.

Step 4: Press Play (I-4) to play the programmed songs in memory

Note: that the program will reset once the Program button is pressed again.

6. To select a folder from an MP3, press Folder button (I-11). Use Forward or Reverse buttons to select a song.

RM-CDV CD/DVD/MP3/SD/USB Player w/Remote and Video Out **OPTION J**



RM-DIGIMP Digital Player w/ Remote **OPTION B**



TV5i Front and Rear Panel Configuration

TV5i-M0100000K9 (Part# for unit shown with options)



J. Rear Panel of TV5i

1. DC Power Input
2. Power Switch
3. Power LED
4. Master
5. Treble
6. Bass
7. Battery meter
8. Voice priority: when activated, Priority LED (9) will light.
9. Voice priority indicator
10. Bluetooth® Button (if equipped)
11. Aux in control
12. Aux in, 1/8" Jack
13. Aux out, 1/8" Jack
14. Mic (wired) in control
15. Mic in, 1/4"/ XLR Combo jack
16. Battery Cover Plate

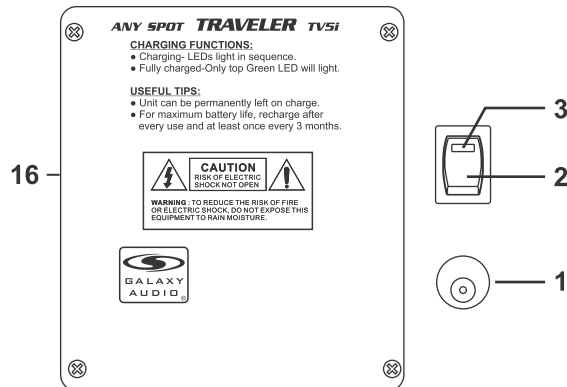
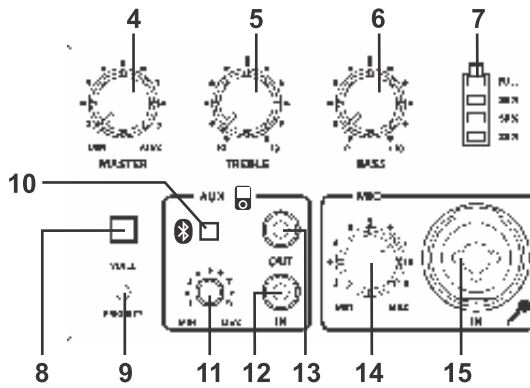

TV5X Panel Configuration

TV5X-M010000K9 (Part# for unit shown with options)

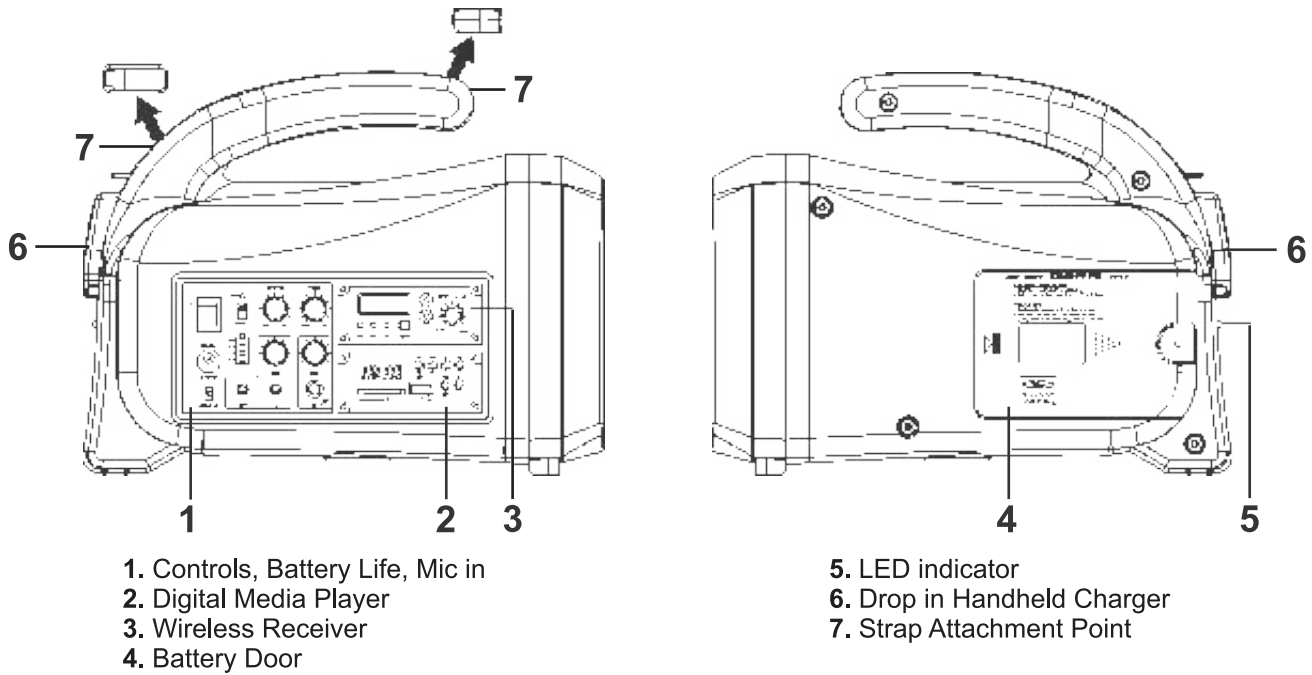

K. Control Panel for TV5X

1. Power
2. Voice priority indicator
3. Voice priority: when activated, Priority LED (2) will light.
4. Master
5. Tone
6. Battery meter
7. DC IN
8. 5V charger
9. Aux out, 1/8" Jack
10. Aux in, 1/8" Jack
11. Aux in control
12. Mic (wired) in control
13. Wired mic input

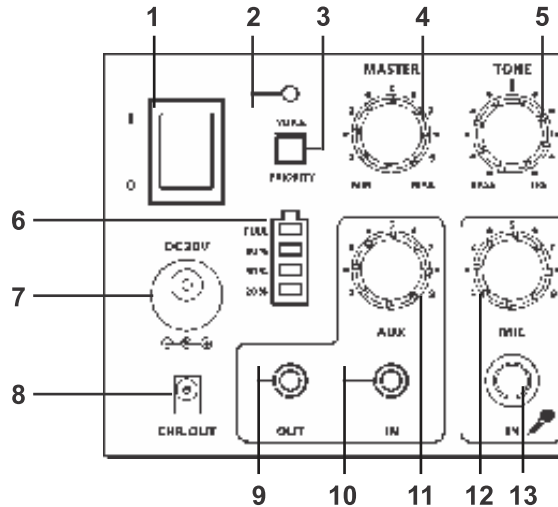

G. For a Description of the Optional Dual Receiver (TV5-DREC) (see page 7).
H. For Optional Bluetooth® Receiver Module (TV5-RECBT) (see page 7).
L. TV5MP3 Optional Media Player for TV5i & TV5X (see page 11).
M. For a Description and Operation of the Optional Wireless Microphone Receiver (TV5-REC) (see page 12).

TV5i & TV5X Battery Replacement Instructions on Page 37.

Guide for TV5i Bluetooth® connection

Turn On and Off:

Press and hold Bluetooth® button for approximately 2 seconds to activate the Bluetooth® function. Press and hold Bluetooth® button for approximately 2 seconds again, to turn the Bluetooth® function off.

Bluetooth® Pairing:

1. When Bluetooth® function is activated successfully, it will emit with a prompt tone.
2. The button will flash Blue as a sign that the device is in pairing mode.
3. Activate the Bluetooth® connection on your smartphone or any Bluetooth® device you are using.
4. Find the device name “Galaxy Traveler” on the pairing list to connect your device.
5. When the pairing is successful, it will emit a prompt tone again and the blue indicator light will be illuminated.
6. You are ready to stream audio from your device.



Caution:

1. During Bluetooth® connection, audio playback will stop when a call is made to your smartphone or tablet. When the call is finished, Bluetooth® will be relinked automatically and audio files will be played.
2. The Bluetooth® connection can be lost when the device gets out of range of the TV5i. When this happens it may automatically re-link when back in range, or it may have to be manually reset. This is dependant on the device and it's operating system. Typical range is ≤ 30'.

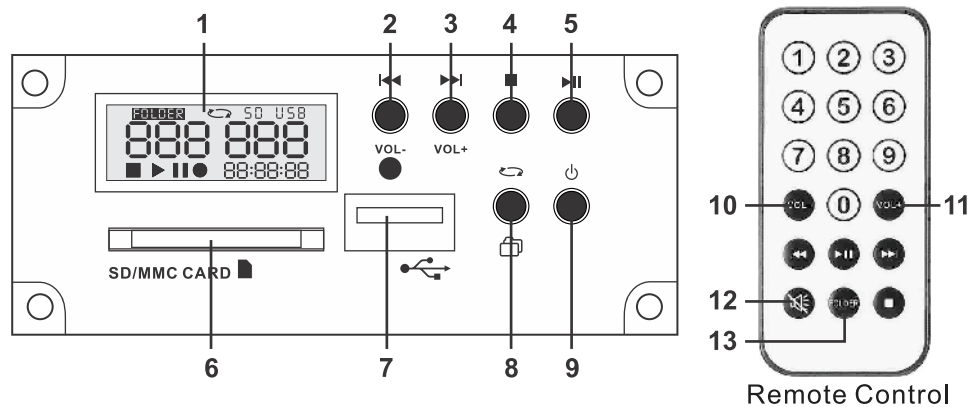
L. TV5MP3 Optional Media Player for TV5i & TV5X



1. LCD display
2. Previous track / volume down (works during playback)
3. Next track / volume up (works during playback)
4. Stop
5. Play / Pause
6. SD/MMC port
7. USB port
8. Repeat / Folder select
9. Power
10. Volume down (MUTE when in minimum level)
11. Volume up
12. Mute
13. Folder select

1. Press and hold the POWER (L-9) button for 1 second to turn TV5MP3 player on. Press and hold the POWER (L-9) button for 1 second to turn off.
2. Press Previous Track/Volume Down (L-2) to play previous audio track; press Next Track/Volume Up (L-3) to play next audio track. Press the STOP (L-4) button to stop any playback.
3. Press PLAY/PAUSE (L-5) button to Play or to Pause any audio track.
4. When both SD card and USB (L-6 and L-7) are installed, USB has higher priority.
5. Do not pull SD card (L-6) out directly or it may be damaged. Push in and SD card (L-6) will eject.
6. Repeat / Folder Select (L-8):
 - a. There are 3 modes for repeat during audio playback.
 -  :To repeat a track.
 -  :To repeat all tracks in all album.
 -  :To repeat all tracks in a single album.
 - b. When not in playback, press Repeat / Folder Select (L-8) to select a desired folder/album with NEXT (L-3) and PREV (L-2) buttons. Finally press PLAY (L-5) to end the setting.
7. During playback, press VOL+ (L-3) to increase volume; press VOL- (L-2) to decrease volume.

Wireless Microphone Receiver Option (TV5-REC)

M. Wireless Microphone Receiver Option (TV5-REC) For TV5i and TV5X

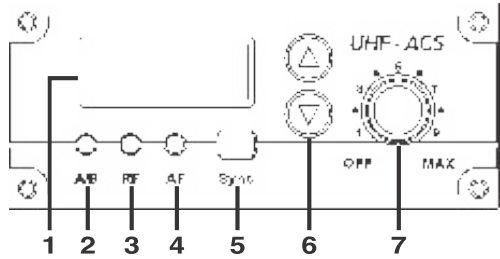

1. LCD window
2. Antenna A and B indicator
3. RF signal indicator
4. AF signal indicator
5. Synchronization button
6. Channel up/down adjustment
7. Receiver power on/off control and volume adjustment

Operation:

Turn receiver volume on/off control (**M-7**) clockwise until a click occurs. A text of “**SYNC**” will appear on LCD window (**M-1**) for about 2 seconds followed by a channel number. To turn it off, turn the control (**M-7**) counter-clockwise until a click occurs. A text of “**OFF**” will appear on LCD window (**M-1**) and will disappear after 2 to 3 seconds.

How SYNC works:

“**SYNC**” function can find a clean channel and assign it to the transmitter in a range, of about 3 m. Turn on your microphone or transmitter first and press SYNC (**M-5**) button, in a few seconds the receiver will have found a clear channel and Synced the transmitter to it. During synchronization, the RF indicator (**M-3**) will blink. When receiving signal, the A/B diversity indicator (**M-2**) will light RED (A) or GREEN (B) to show the normal condition. The AF indicator (**M-4**) will show audio received.

Change channel manually:

Press and hold UP or DOWN (**M-6**) button for 1 second until channel number is blinking. Select a desired number using the UP or DOWN (**M-6**) button. The selected channel number will be confirmed in 1 second if no other adjustment is made.

- * When you have more than 1 receiver complete the channel setup in one receiver first and then set up the second receiver.
- * Be sure to use a different channel number for each receiver.

WIRELESS TRAVELER TRANSMITTERS



AND RECEIVER (p. 21)



TVHH Microphone Description & Functions

N. Description of Functions for Handheld Microphone TVHH

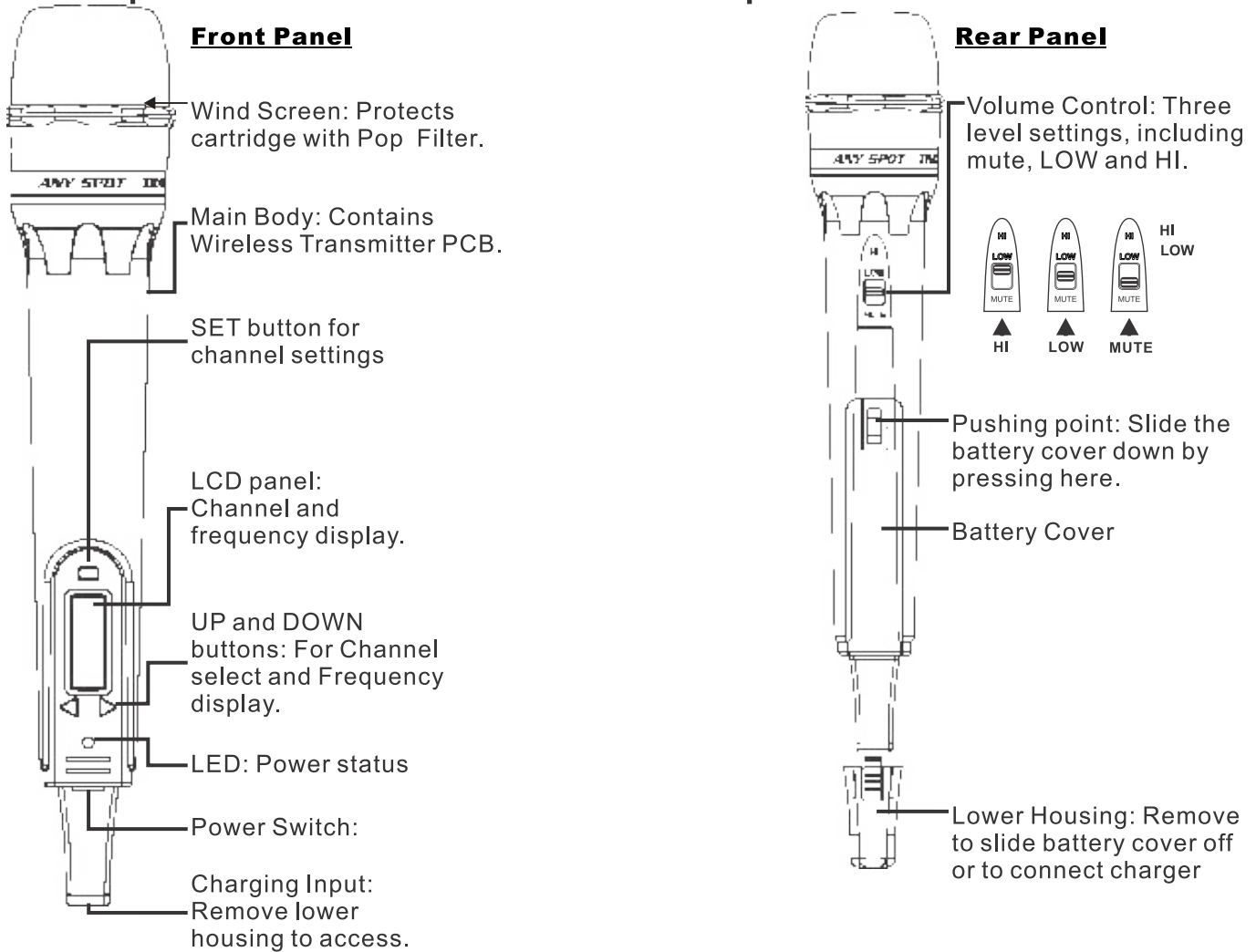

Operation of Handheld Microphone TVHH

A. Battery Installation Steps:

1. Turn off the microphone before inserting batteries.
2. Press in the latch to release the lower housing and slide it off.
3. Press in the latch to release the battery cover and slide it down.
4. Insert 2 disposable batteries of 1.5V type or 2 rechargeable batteries of 1.2V type.
5. Observe proper polarity while inserting batteries.
6. Slide the battery cover back to its original position.
7. Install the lower housing back to the lower part of the microphone.

B. Switch-On Steps:

1. Press the power switch and hold for about two seconds until the LED turns to RED and "on" is displayed in the LCD.
2. The LCD will then automatically display the selected channel.



:Channel indicator.



:Press and hold the Up or Down button to display the corresponding frequency.

C. Switch Off steps:



1. Press and hold power switch for about two seconds until the LCD displays OFF.

OFF

D. Channel/Frequency Settings (with power on):

1. Press the SET button and hold for about 2 seconds.
2. The Channel number display will start flashing.
3. Press the Up button to display a higher numbered channel.
4. Press the Down button to display a lower numbered channel.
5. Press the SET button to activate the selected channel.

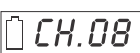

E. LCD Indications:

1.  : Three bars means batteries are fully charged.
2.  : One bar indicates low batteries. Replace or recharge the batteries.
3.  : No bars showing indicates batteries are exhausted and after flashing three times the power will automatically shut off.

F. Battery Charging Steps:

1. Rechargeable batteries need to be NiMH AA 1.2V with an amperage of 2100mAh or less as the charging function is limited to batteries of this rating.
2. Recharging is best accomplished by using the AS-DCTVHH charger.

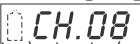
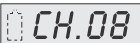
3. Charging status:

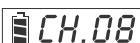
- a.  Battery indicator flashing: Non-Rechargeable batteries installed or no batteries installed. Check the batteries.
- b.  Battery indicator is flashing and LCD backlight is on: Failing, corroded, or over-temperature batteries.
- c.  One or two bars showing: Batteries are charging successfully.
- d.  Three bars showing: Batteries have been fully charged.

* Please note the microphone will be turned off automatically while it is being charged.

G. Troubleshooting:

1. LED doesn't light when power switch is pressed to turn on mic.

- a. Make sure that the batteries are not discharged.
- b. Make sure that the batteries are installed correctly.

2. LCD shows when power switch is pressed to turn mic off.

- a. Press the SET, UP and DOWN buttons at the same time in order to turn the microphone off automatically. The LCD display will flash about ten times and then the microphone will turn off automatically. The microphone should now turn on and off normally.
- b. If the problem persists, call for service.

3. LCD panel shows unusual indications.

- a. Remove the batteries from the microphone and re-install them.

4. No audio from microphone.

- a. Check that the frequency of the transmitter is the same as that of the receiver.
- b. Make sure that the Mic switch is not set to Mute.
- c. Check if the distance between the transmitter and the receiver is too great.
- d. Check if the transmitter or the receiver is too close to any large metal objects.
- e. Make sure receiver and master volume are up.

5. Interference and signal Disturbance.

- a. Make sure there are no other wireless systems operating on the same frequency in the same area. This includes Microphones, televisions, radio stations, etc. Try setting the transmitter and receiver to a new channel.

H. Q&A

1. **Q:** How long can the microphone be operated with fully charged batteries?
A: Re-chargeable batteries will last approximately 8 to 10 hours. Disposable batteries will last approximately 13 hours.
Q: How much time is required to recharge batteries from a fully exhausted state?
A: Approximately 4 to 5 hours.

TVH2 Microphone Description & Functions

O. Description of Functions for Handheld Microphone TVH2

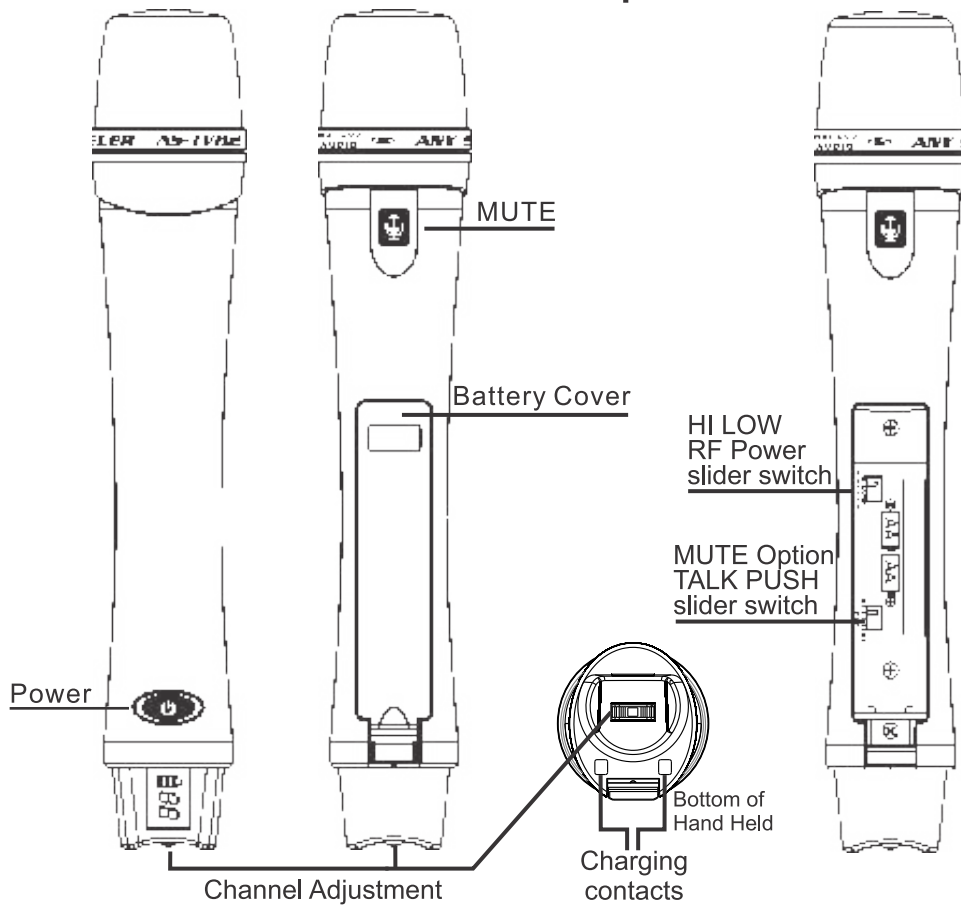

Operation of Handheld Microphone TVH2

A. Battery Installation Steps:

1. Turn off the microphone before inserting batteries.
2. Press in the latch to release the battery cover and slide it down.
3. Insert 2 disposable batteries of 1.5V type or 2 rechargeable batteries of 1.2V type.
4. Observe proper polarity while inserting batteries.
5. Slide the battery cover back to its original position.
6. Install the lower housing back to the lower part of the microphone.

B. Switch-On Steps:

1. Press the power switch and hold for about two seconds until the LED turns to Blue and  is displayed in the LCD.
2. The LCD will then automatically display the selected channel.

 :Channel indicator.

C. Switch Off steps:

1. Press and hold power switch for about two seconds until the LCD displays .

D. Channel/Frequency Settings (with power on):

1. Press the Channel adjustment button in and hold for about 3 seconds.
2. The Channel number display will start flashing.
3. Press the Channel adjustment button to the right to display a higher numbered channel.
4. Press the Channel adjustment button to the left to display a lower numbered channel.
5. Press the Channel adjustment button in to activate the selected channel.

E. Power Settings:

1. Remove battery cover and batteries, the switch is under the batteries.
2. Slide the RF Power switch to the desired position HI for 10mW low for 1mW





TVBPT Body Pack Transmitter Description & Functions

F. Mute options

1. Remove battery cover and batteries, the switch is under the batteries.
2. With the switch in the talk position the microphone is on until you press the mute button.
3. With the switch in the Push position the microphone is muted until you press and hold the mute button.
4. In either position, when the mute switch is green the microphones is on, when the mute button is red the microphone is muted.

F. LCD Indications:

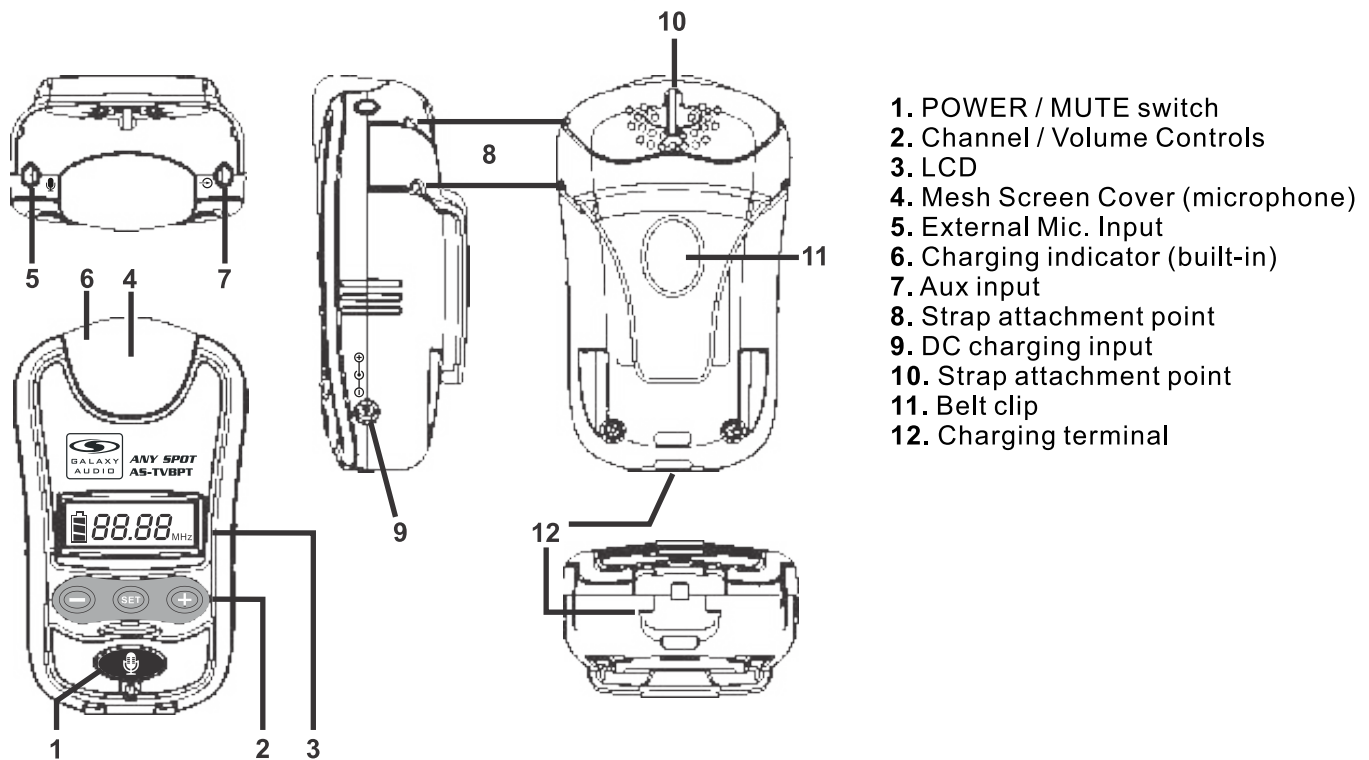

1.  :Three bars means batteries are fully charged.
2.  :One bar indicates low batteries. Replace or recharge the batteries.
3.  :No bars showing indicates batteries are exhausted and after flashing three times the power will automatically shut off.

P. Description of Functions for Body Pack Transmitter TVBPT



Operation of TVBPT Transmitter

A. Switch-On Steps:

1. Press the power switch and hold for about two seconds until the LED turns to Blue and  is displayed in the LCD.
2.  The LCD will then automatically display the selected channel.

B: Volume adjust

1.  Press the + button to increase press the – button to decrease. The range is 3 steps.

D. Channel/Frequency Settings (with power on):

1. Press the Set button in and hold for about 3 seconds.
2. The Channel number display will start flashing. 
3. Press the + button to display a higher numbered channel.
4. Press the - button to display a lower numbered channel.
5. Press the set button to activate the selected channel.

E. Switch Off steps:

1. Press and hold power switch for about two seconds until the LCD displays 

TVMBP Body Pack Transmitter Description & Functions

Q. Description of Functions for Body Pack Transmitter TVMBP

1. Mini XLR Mic input jack (TA3M)
2. Power switch
3. Mute button
4. Antenna
5. Power light
6. Charging Jack
7. LCD light
8. Set button
9. Channel select button
10. Sensitivity control
11. 3.5mm aux input jack
12. Belt clip
13. Battery compartment
14. Battery cover

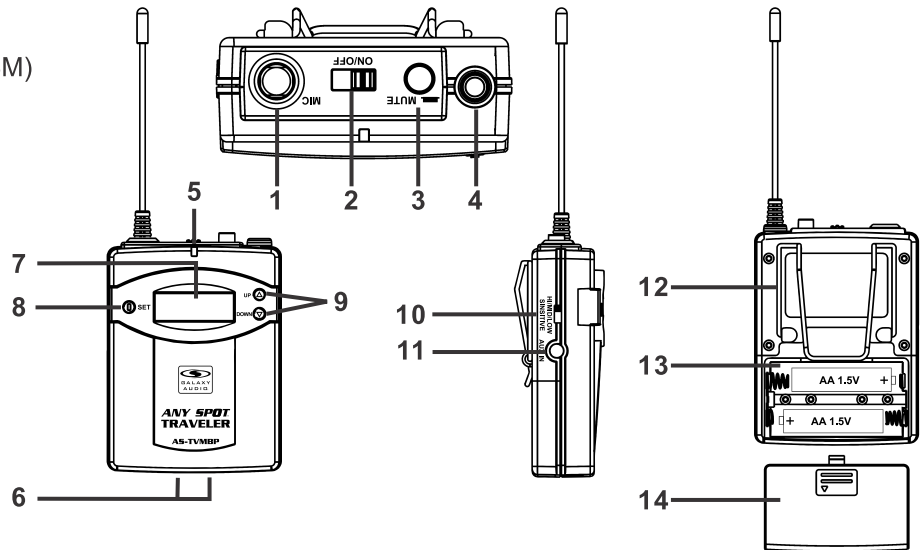

Operation of TVMBP Body Pack Transmitter

A. Battery Installation:

1. Switch the transmitter off before inserting batteries.
2. Slide the battery cover off.
3. Insert 2 disposable batteries (1.5V AA) or 2 rechargeable batteries (1.2V AA).
4. Observe correct polarity when inserting batteries.
5. Slide the battery cover back to its original position.



B. Turning unit on:

1. Switch the power to ON position
2. The RED LED will light and the LCD will display "On".  If no other operation is performed, LCD light will go off automatically in 5 seconds.

C. Channel/Frequency Settings:

1. Press and hold the SET button for approximately 2 seconds until the channel number flashes.
2. Release the SET button and the current channel will keep flashing
3. Press the UP or DOWN buttons to select a different channel.
4. When the desired channel is displayed press the SET button again. The display will stop flashing and stay on the channel selected.
5. Press and hold the UP or DOWN buttons to display the frequency associated with the channel number selected.

D. LCD Indications:

1.  Batteries fully charged and channel 08 selected.
2.  One bar displayed indicates low-battery. The batteries need to be changed or rechargeable batteries need to be recharged.
3.  No bars displayed indicates the batteries are exhausted and after flashing three times, the power will automatically shut off.

E. Battery Charging Steps:

1. Insure that the batteries are the rechargeable type.
2. Switch Power to OFF position.
3. Insert TVMBP into its own intelligent charger stand (AS-DCTVMBP).
4. Batteries will recharge automatically.
5. For more details of charger stand please refer to AS-DCTVMBP user guide.

F. Turning the unit OFF:

1. Slide the power switch to the OFF position.
2. LCD display will show "OFF" 

If there is no further operation, the Power LED and LCD will switch off automatically.

G. Troubleshooting

1. No LCD display when the unit is switched on.
 - a. Make sure the batteries are not discharged.
 - b. Make sure the batteries are installed correctly.
2. LCD shows Err when switched on.
 - a. Switch power OFF, repeat steps for turning unit on.
 - b. If the problem persists, call for service
3. No Audio from Transmitter.
 - a. Check that the Transmitter and Receiver are on the same channel.
 - b. Check if "MUTE" is activated.
 - c. Check if the volume control of the receiver is set to a proper position.
 - d. Check if the Transmitter and Receiver are within the operating distance range.
4. Interference and signal disturbances.
 - a. When two Transmitters are being used, select different frequencies. If voice disturbance still occurs try selecting another channel until interference is gone.
 - b. Make sure there are no other wireless systems operating on the same frequency in the area. This includes other wireless microphones, television or radio stations, etc. Try setting the Transmitter and Receiver to a new channel.

Maintenance

Avoid Excessive Heat

Don't leave transmitter or receiver in hot sun, on a radiator, or near other sources of high temperature.

Avoid Rough Handling

The transmitter and receiver may be damaged if dropped.

Storage

Before storage, fully charge the batteries in both transmitters and receivers. If possible, recharge once a month during storage and again before first use.

Storage (Long term)

Remove the internal batteries when storing the units for a long period of time.

Replacing Batteries

Observe the correct polarity when installing batteries. Replace batteries only with the same or equivalent type.

Battery Terminals

Keep the contacts clean and inspect them often to insure they are not corroded. If they become corroded, polish them with a pencil eraser.

R. AS-TXRM Stationary Transmitter

The AS-TXRM is a stand alone version of our AS-TVTX Audio Link Transmitter module. The module is housed in a standard half-rack sized enclosure, and includes a variety of inputs and outputs as well as mixing controls. The AS-TXRM is great for transmitting the entire mix from a mixing console to one or more Traveler speakers equipped with wireless receivers.

AS-TXRM Stationary Transmitter

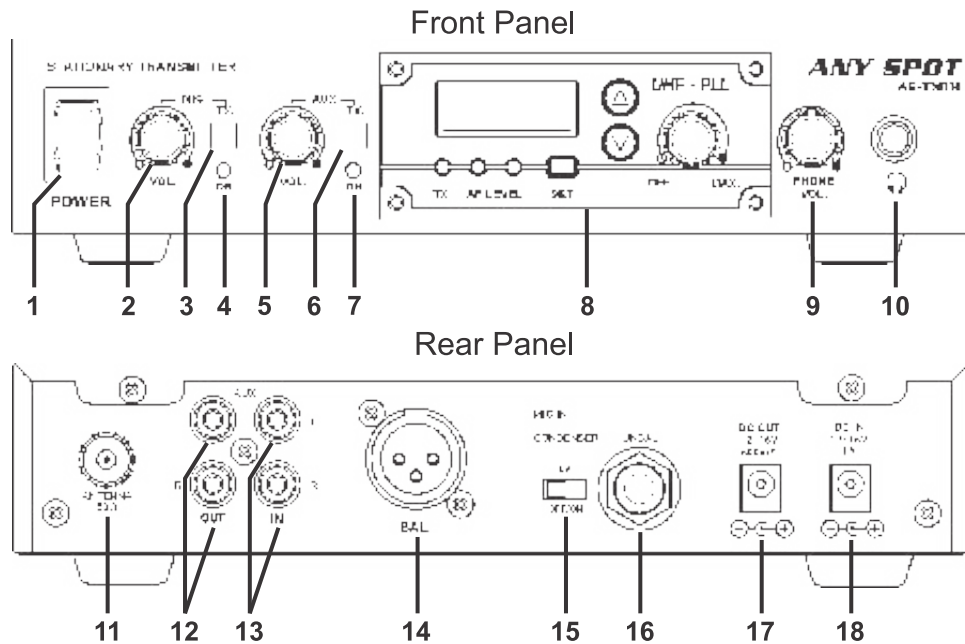

- | | | |
|------------------------|-----------------------|--------------------------|
| 1. Power Switch w/ LED | 7. Aux On LED | 13. L/R Aux Inputs |
| 2. Mic Volume | 8. Transmitter Module | 14. Balanced Mic Input |
| 3. Mic On/Off Switch | 9. Headphone Volume | 15. 5v DC Mic Switch |
| 4. Mic On LED | 10. Headphone Output | 16. Unbalanced Mic Input |
| 5. Aux Volume | 11. Antenna Connector | 17. 12-15v DC Output |
| 6. Aux On/Off Switch | 12. L/R Aux Outputs | 18. 12-15v DC Input |

Setup and Operation of AS-TXRM

- Starting with both the main power switch off (R-1) and the transmitter (R-8) power switch off, plug the included power supply into the DC In jack (R-18), and then plug the other end into an AC outlet. Connect the supplied antenna to the Antenna Jack (R-11).
- Set all volume controls (R-2), (R-5), & (R-9) to the minimum. Set the input TX switches (R-3) and (R-6) to off, and then switch on the power (R-1).
- Connect the desired source devices (such as a microphone or line output of a mixer) to the appropriate AS-TXRM inputs. The XLR input (R-14) will accept balanced mic level signals. The 1/4" input (R-16) will accept unbalanced mic level signals, and provide 5v DC to condenser mics when desired, by activating the switch (R-15). These two inputs are controlled by the Mic Volume (R-2) and TX switch (R-3). The L/R Aux Inputs will accept a stereo line level signal, and are controlled by the Aux Volume (R-5) and TX switch (R-6). When the TX switches (R-3) and (R-6) are engaged, the respective LEDs (R-4) and (R-7) will light, indicating that the input signal is being sent to the Transmitter Module (R-8) and the L/R Aux Output jacks.
- Switch on the Transmitter Module (R-8) and set it according to the Audio Link System instructions provided on page 13.
- Set the receiver(s) according to the Wireless Mic Receiver instructions provided on page 12.
- Start sending a signal from the source device and set various volume controls (in the signal chain from the source to the receiving device) to the desired levels. It is important to set the gain structure properly to achieve the best signal to noise ratio. Normally you will want to set the output of the source as high as possible without causing distortion to the input of the following device, and so on down the line.
- Signals sent to the L/R Aux Input will appear at the Headphone Jack (R-10) and be controlled by the Phone Volume (R-9). Note: Signals from the Mic Inputs (R-14) and (R-16) do not appear at the Headphone Jack.
- The DC Output Jack (R-17) supplies 12v DC for charging or powering other devices. Make sure any device connected to this jack complies with the voltage and current rating listed for this jack.

S. Description of Functions for Body Pack Receiver TVBPR

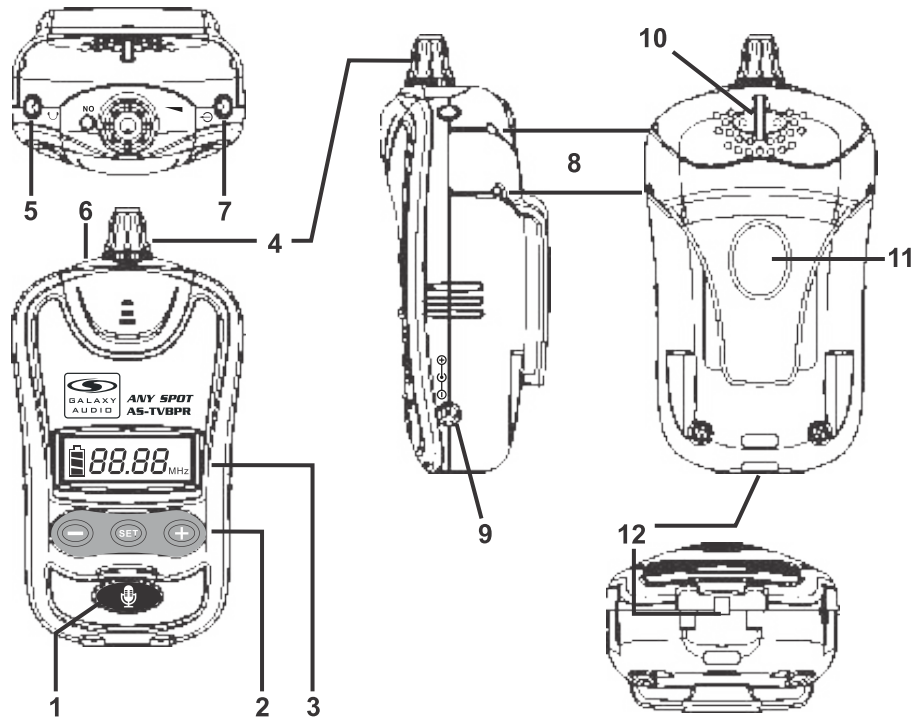

- | | |
|----------------------------------|----------------------------|
| 1. MUTE switch | 7. Line out |
| 2. Channel Select | 8. Strap attachment point |
| 3. LCD | 9. DC charging input |
| 4. Power / Volume Control | 10. Strap attachment point |
| 5. Audio out | 11. Belt clip |
| 6. Charging indicator (built-in) | 12. Charging terminal |

Operation of AS-TVBPR Body pack Receiver

A. Switch-On Steps:

1. Turn the power/volume control clockwise is displayed in the LCD.
2. The LCD will then automatically display the selected channel.

B: Volume adjust

1. Turn the power/volume control clockwise to increase, turn counter clockwise to decrease.

C: Mute

1. Press the mute button, it will turn red to indicate mute.

D. Channel/Frequency Settings (with power on):

1. Press the + button to display a higher numbered channel.
2. Press the - button to display a lower numbered channel.
3. Press the set button to display the frequency.

E. Switch Off steps:

1. Turn the power/volume control completely counter clockwise until it clicks off.

F. Charging the TVBPT and AS-TVBPR

1. These units have permanent rechargeable lithium batteries.
2. Plug the provided charger into the body pack and an AC power source when the battery display shows empty.
3. An optional cradle charger that will charge two body packs at a time is available.

Optional Traveler Accessories

Optional Traveler Accessories

AS-DCBPTR



DC CHARGER FOR PENDANT STYLE TRANX/REC: for use with TVBPT & AS-TVBPTR Traveler pendant transmitter and receiver.

TV5iBAG



TV5i CARRY BAG: TV5i CARRY BAG.

AS-DCTVMBP



DC CHARGER FOR TRAVELER BODY PACK TRANSMITTER: charges two body packs at once.

TV5XBAG



TV5X CARRY BAG: TV5X CARRY BAG.

HS-U3BK



UNI HEADSET MIC: Uni-directional headset microphone (wrap around head), TA3F connector, 50Hz-18kHz, mic diameter 12.25mm.

BAGTV



TRANSPORT BAG: Extendable handle w/ wheels. Will hold 1 Traveler, up to 3 Hot Spot sized monitors or up to 6 Micro Spot sized monitors, and many accessories.

LV-U3BK



UNI LAV/LAPEL MIC: Uni-directional lav/lapel microphone, TA3F connector, 50Hz-19kHz mic diameter 13mm.

AS-TV8COVER



TRAVELER 8" SLIP COVER: protective slip cover for Traveler 8 has storage space and handle access.

AS-DCTVHH



DC CHARGER FOR TRAVELER HANDHELD MICROPHONE.

AS-TV10COVER



TRAVELER 10" SLIP COVER: protective slip cover for Traveler 10 has storage space and handle access.

TV8U



TRAVELER 8 PASSIVE: 2 way; 8" woofer, 1" horn, 2-1/4" parallel inputs, 70-20kHz, speaker stand mount, carrying handle.

MST-C60

60" COMBINATION MIC STAND: Short straight or boom microphone stand. Can be a 63" tall straight tripod stand or a 41" tripod stand with 23" boom arm.

MST-C90

90" COMBINATION MIC STAND: Tall straight or boom microphone stand. Can be a 93" tall straight tripod stand or a 62" tripod stand with 30" boom arm.

MST-T50

TRIPOD STAND TILT, SWIVEL LEGS & BOOM: Mic stand w/ tilt, swivel legs, and pistol grip, all metal construction. Designed to work in a range of applications. Stand height: 41"-65" (1m-1.63m), boom length 18"-33" (0.5m-0.86m), weighs 6.75lbs (3.06kg) base radius 22" (56cm).

MST-18

ECO TRIPOD STAND W/ BOOM: Economical tripod mic stand, stand height 33"-56.5" (0.84m-1.44m), boom length 12.8" (0.33m), weight 3.3lbs (1.5kg), base radius 19.5" (0.50m).

MST-25

TRIPOD STAND W/ BOOM: Tripod mic stand with boom, stand height 49"-69" (1.245m-1.75m), boom length 19.75"-34.75" (0.5m-0.8m), weight 4.2lbs (1.9kg), base radius 19.75" (0.50m).

SST-TV5

TRIPOD STAND FOR TV5 SERIES: Works with both TV5X and TV5i.

SST-35

TRIPOD SPEAKER STAND: Tripod speaker stand, stand height 51"-76" (1.29m-1.93m), weight 7.2lbs (3.27kg), base radius 31.5" (0.80m).

SST-45

DELUXE TRIPOD SPEAKER STAND: Deluxe speaker stand, stand height 58"-80.75" (1.47m-2.05m), weight 9lbs (4kg), base radius 40.5" (1.03m).

LSR38

LIFE SAVER: Durable reinforced vinyl, weighs up to 38lbs w/ sand, 21lbs w/ water. The weight of the mic and boom can offset the balance of the mic stand and cause it to tip. The Life Saver will also help stabilize a top-heavy speaker stand with a speaker on top.

SDB40

LIFE SAVER: Dual wing design, durable reinforced vinyl, weighs up to 40lbs w/ sand, 25lbs w/ water. Nylon handle with clip. Helps protect equipment from damage and keeps stands upright and stable. Use with lighting, speaker, and PA equipment stands.

Replaceable Traveler Parts

Replaceable Traveler Parts

BATTCVRTV5X

Back panel battery cover for the TV5X.



BATTCVRTV5i

Back panel battery cover for the TV5i.



TV5XMICCVR

Microphone compartment door for the TV5X.



WS-TVH2

TVH2 Handheld Microphone windscreen.



TV5XSTRAP

Adjustable shoulder strap for the TV5X.



AS-BATTCTVH2

TVH2 Handheld Microphone battery cover.



TV5XSTRAPPIN

Strap Pin for the TV5X.



WS-TVHH

TVHH Handheld Microphone windscreen.



PSU-20-3.25-5.5

Power Supply for the TV5X and TV5i.



AS-BATTCTVHH

TVHH Handheld Microphone battery cover.



TV5XCHGCBL

Transmitter charger for the TV5X.



AS-TVHHANTCVR

Standard antenna cover for the TVHH.



AS-ANT625TNC

Antenna for the TXRM.



AS-TXRMRE

Rack Kit for the AS-TXRM.



BATTTVBPTR

3.7V Battery for the AS-TVBPR & TVBPT.



AS-BATTCTVMBP

Battery cover for the TVMBP.



CLIPTVBPTR

TVBPT and AS-TVBPR Belt Clip.



AS-CLIPMBP

TVMBP Belt Clip.



LANTVBPR

Lanyard for the AS-TVBPR.



LANTVBPT

Lanyard for the AS-TVBPT.



CAUTION

Danger of explosion if the battery is incorrectly installed.
Replace only with the same or the equivalent type.

TV10

Specifications Portable Amplifier Speaker

Sensitivity	92 dB, 1Watt @ 1 M
Maximum SPL	112 dB
Frequency Response	20 Hz ~ 20 kHz (audio)
Speakers	10" LF Woofer, 1" HF Horn
Receiver Module (Optional)	TV-REC x 2 @ diversity/TV-DREC TV-RECBT
Antenna	Built-in antenna
Output Power	100 Watt (RMS), 140W (MAX) @ 4 Ω
Signal to Noise Ratio	Up 70 dB
CD/Media Players (Optional)	RM-CD/CDV/DIGIMP
Audio Link TX (Optional)	AS-TVTX transmitter
Audio Input	XLR - Mic in, 6.5 mm - Mic in, RCA - Line in, 3.5 mm - Aux in
Audio Output	RCA - Line out, 3.5mm - Aux out
Controls	Wireless, MIC, Bass, Treble, Master, AUX & LINE
Power Requirement	100-240V AC 50/60Hz
Battery	12V, 4.5Ah * 2 (Lead-Acid) rechargeable batteries
Operating Life	4 ~ 6 Hours (tested at 10+ hours)
Charging Time	5 Hours
Operating Distance	164' - 197' (50 - 60 meters)
Dimensions (H x W x D)	22.83" x 14.17" x 12.2" (580 x 360 x 310 mm)
Weight	44 lbs (20 kg) (batteries included)

CAUTION

Danger of explosion if the battery is incorrectly installed.
Replace only with the same or the equivalent type.

TV8

Specifications Portable Amplifier Speaker

Sensitivity	92 dB, 1Watt @ 1 M
Maximum SPL	109 dB
Frequency Response	70 Hz ~ 20 kHz (audio)
Speakers	8" LF Woofer, 1" HF Horn
Receiver Module (Optional)	TV-REC x 2 @ diversity/TV-DREC TV-RECBT
Antenna	Built-in antenna
Output Power	50 Watt (RMS), 80W (MAX)
Signal to Noise Ratio	Up 70 dB
CD/Media Players (Optional)	RM-CD/CDV/DIGIMP
Audio Link TX (Optional)	AS-TVTX transmitter
Audio Input	XLR - Mic in, RCA - Line in
Audio Output	RCA - Line out, SPK out (unswitched)
Controls	Mic., Line, Bass, Treble, Master
Power Requirement	100-240V AC 50/60Hz
Battery	12V, 2.9Ah * 2 (Lead-Acid) rechargeable batteries
Operating Life	4 ~ 6 Hours (tested at 10+ hours)
Charging Time	4 ~ 6 Hours
Operating Distance	164' - 197' (50 - 60 meters)
Dimensions (H x W x D)	18.5" x 9" x 12" (470 x 230 x 300 mm)
Weight	26.5 lbs (12 kg) (batteries included)

CAUTION

Danger of explosion if the battery is incorrectly installed.
Replace only with the same or the equivalent type.

TV5i

Specifications Portable Amplifier Speaker

Sensitivity	88 dB, 1Watt @ 1 M
Maximum SPL	104 dB
Frequency Response	70 Hz ~ 16 kHz (audio)
Speakers	5" Woofer, 1" Tweeter
Receiver Module	TV5-REC x 2 diversity/TV5-DREC TV5-RECBT (all optional)
Output Power	40 W (RMS) @ 4ohm
Signal to Noise Ratio	Up 70 dB
Optional Media Player	TV5MP3 (optional)
Audio Input	¼"/XLR Combo-Mic. In, 1/8"-Aux In
Audio Output	1/8"-Aux Out,
Controls	Master, Tone, Aux In, Mic
Range	150' (50 meters)
Power Supply	20VDC 3.25A
Battery	12V, 2.9Ah (Lead-Acid) rechargeable battery
Running Time	4 ~ 5 Hours
Charging Time	3 ~ 4 Hours
Dimensions (H x W x D)	10.9" x 6.7" x 7.9" (276 x 170 x 200 mm)
Weight	8.15lbs (3.7 kg)

CAUTION

Danger of explosion if the battery is incorrectly installed.
Replace only with the same or the equivalent type.

TV5X

Specifications Portable Amplifier Speaker

Sensitivity	88 dB, 1Watt @ 1 M
Maximum SPL	104 dB
Frequency Response	70 Hz ~ 16 kHz (audio)
Speakers	5" Neolite Speaker
Receiver Module	TV5-REC x 2 diversity/TV5-DREC TV5-RECBT (all optional)
Output Power	40 W (RMS) @ 4ohm
Signal to Noise Ratio	Up 70 dB
Optional Media Player	TV5MP3 (optional)
Audio Input	¼"-Mic. In, 1/8"-Aux In
Audio Output	1/8"-Aux Out,
Controls	Master, Tone, Aux In, Mic
Range	150' (50 meters) to 220' (70 meters)
Power Supply	20VDC 3.25A
Battery	12V, 2.9Ah (Lead-Acid) rechargeable battery
Running Time	4 ~ 5 Hours
Charging Time	3 ~ 4 Hours
Dimensions (H x W x D)	9.7" x 6" x 13.11" (246 x 153 x 333 mm)
Weight	7 lbs (3.1 kg)

Wireless Mic/Audio Link Receiver Module (TV-REC)

Oscillation Type	PLL synthesized control OSC
Adjustable Frequency	Pre-programmed max. 96 switchable channels
Switching Bandwidth	Max. 12 MHz
Ambient Temperature	-10 °C ~ 50 °C
Maximum Deviation	50 kHz, with level limiting
Dynamic Range	110 dB
T. H. D.	Less than 0.5%
Pre/De- Emphasis	50 μ s
Squelch	Tone key and noise lock dual-squelch
Frequency Response	70 Hz ~ 16 kHz (wireless)
Operating Range	160 - 230 feet (50 ~ 70 M) (open field) with built-in antenna
Antenna Mode	Diversity
Sensitivity	4 μ V @ 30 dB SINAD
Double Intermediate	110.6 Mhz / 10.7 MHz
Display Status	LCD indicator displays channel or frequency
Channel Select	SYNC, UP, DOWN keys
RF Spurious Rejection	70 dB
Adjacent Channel Performance	68 dB @ 250kHz
IMD Rejection	58 dB
Carrier Frequency Range	640 ~ 664 MHz
Antenna	Built-in or external
Dimensions (L x W x H)	5.25" x 3.46" x 1.45" (133 x 88 x 37 mm)
Weight	3.88 oz. (110 g)

Dual Receiver Module (TV-DREC/TV5-DREC)

Oscillation Type	PLL synthesized control OSC
Adjustable Frequency	Pre-programmed max. 96 switchable channels
Switching Bandwidth	Max. 12 MHz
Ambient Temperature	-10 °C ~ 50 °C
Maximum Deviation	50 kHz, with level limiting
Dynamic Range	110 dB
T. H. D.	Less than 0.5%
Pre/De- Emphasis	50 μ s
Squelch	Tone key and noise lock dual-squelch
Frequency Response	70 Hz ~ 16 kHz (wireless)
Operating Range	160 - 230 feet (50 ~ 70 M) (open field) with built-in antenna
Antenna Mode	Single
Sensitivity	4 μ V @ 30 dB SINAD
Double Intermediate	110.6 Mhz / 10.7 MHz
Display Status	LCD indicator displays channel or frequency
Channel Select	SET, UP, DOWN keys
RF Spurious Rejection	70 dB
Adjacent Channel Performance	68 dB @ 250kHz
IMD Rejection	58 dB
Carrier Frequency Range	520 ~ 544 MHz
Antenna	Built-in or external
Dimensions (L x W x H)	5.25" x 3.46" x 1.45" (133 x 88 x 37 mm)
Weight	3.88 oz. (110 g)

Audio Link Transmitter Module (AS-TVTX also used in TXRM)

RF Output	10mW
Spurious Emission	Less than 250 nW
Display Status	LCD indicator displays channel or frequency
Channel Select	SET, UP, DOWN keys
Antenna	Built-in or external
Dimensions (L x W x H)	4.25" x 7.5" x 1.75" (108 x 190 x 44 mm)
Weight	5.99 oz. (170 g)

Handheld Microphone (TVHH)

Microphone Type	Cardioid dynamic capsule
RF Output	10mW
Spurious Emission	Less than 250 nW
Display Status	LCD indicator displays channel or frequency, battery condition
Channel Select	SET, UP, DOWN keys
AF Controls	Hi/Low/Mute switch
Battery	1.2 V (Ni-MH 1300 mAh) * 2 AA type rechargeable battery 1.5V * 2 AA Alkaline disposable
Battery Life Ni-MH Rechargeable	11 hours typical
Battery Life Alkaline Disposable	14 hours typical
Antenna	Built-in
Dimensions (Dia x L)	1.8" x 10.4" (46 x 264 mm)
Weight with Battery	9.87 oz. (280 g)

Handheld Microphone (TVH2)

Microphone Type	Uni-Directional Condenser 16.5mm Element
RF Output	10mW/1mW
Frequency Response	70Hz-16kHz
Channels	16 or 96
Indicators	Power, Mute/Talk
Display	Back Lit LCD (Channel, 3 bar battery indicator)
Battery	2- AA type (Ni-MH 1600 mAh) Rechargeable battery 1.5V 2- AA Alkaline disposable
Battery Life Alkaline Disposable	12 to 16 hours typical
Antenna	Built-in
Dimensions (Dia x L)	1.16" x 7.9" (37 x 200 mm)
Weight with Battery	0.20 oz. (90.7 g)

Body Pack Transmitter (TVMBP)

Microphone Type	Headset or Lavalier
RF Output	10mW
Spurious Emission	Less than 250 nW
Display Status	LCD indicator displays channel or frequency, battery life
Channel Select	SET, UP, DOWN keys
AF Controls	Mute switch, Hi/Mid/Low switch
Audio Input	Mic in, Aux in
Battery	1.2 V (Ni-MH 1300 mAh) * 2 AA type rechargeable battery 1.5V * 2 AA Alkaline disposable
Battery Life Ni-MH Rechargeable	11 hours typical
Battery Life Alkaline Disposable	14 hours typical
Housing	Aluminium
Dimensions (H x W x D)	3.48" x 2.52" x 1.04" (88 x 64 x 27 mm)
Weight with Battery	4.48 oz. (127 g)

Body Pack Transmitter (TVBPT)

Microphone	Built-in Microphone
RF Output	10mW/1mW
Frequency Response	Aux: 70Hz-15kHz Headphone: 100Hz-15kHz
Display	LCD indicator displays channel, frequency, 3 bar battery life & volume
Channels	16 or 96
Indicators	RF/Mute LED, Charging "ON" LED
Inputs	1 -3.5 mm Mic Input and 1 - 3.5 mm Line Input
Battery	Rechargeable Lithium Battery
Battery Life	12 - 16 hours typical
Dimensions (H x W x D)	3.46" x 2.05" x 1.34" (88 x 52 x 34 mm)
Weight with Battery	3.2 oz. (90 g)

Digital Media Player (TV5MP3)

Frequency Response	20Hz ~ 20kHz
Power Requirement	DC 12 V
Display	Backlit LCD
Output Level	600mV
Supported Format	MP3
S/N Ratio	> 60 dB
T.H.D.	<1%
Remote Range	10' (3 meters)
Controls	Play, Stop, Repeat, Next, Previous
Supported Audio External	USB, SD card

Body Pack Receiver (AS-TVBPB)

Frequency Range	UHF 640~664 MHz
Selectable Frequencies	Pre-programmed 96 switchable frequencies
Case	Plastic
Oscillator	PLL synthesized
Receiving Mode	PLL Single channel
Sensitivity	Sinad > 20 dB @ Ear.out:500 mV, RF=-105 dBm, f=1 kHz, Mod=14 kHz.
AUX Output Level @ 1kΩ	300 mV 2RF=-60 dBm, f=1 kHz, Mod=14 kHz
Ear. Output Level	1.4V @ VR max., RF=-60 dBm, f=1 kHz, Mod=14 kHz.
Ear. Output T.H.D.	<1% @ Ear.out:500mV, RF=-60 dBm, f=1 kHz, Mod=14 kHz.
S/N	>60 dB @ with AS-TVBPB, f=1 kHz, MIC IN = -30 dBv
Frequency Response - Aux	70 Hz ~ 12 kHz @with AS-TVBPB Aux
Frequency Response - Ear.	100 Hz ~ 12 kHz @with AS-TVBPB Mic
Tone Squelch Frequency	38 kHz.
Operating Range	Hi: > 50 M, Low: >30 M
Earphone & AUX Out	3.5 mm TRS
Built-in Speaker	8 Ω / 1 W
Battery	Li-ion 3.7 V 1200 mAh.
Battery Life	up to 18 hours
Battery Full Charge Time	3 ~ 4 hours
LCD Display	Channel, Frequency, Battery
Dimensions (H x W x D)	3.86" x 2.04" x 1.34"(98 x 52 x 34 mm)
Weight	3.2 oz (90 g)

Notice: Changes or modifications not expressly approved by the party responsible for compliance could void the user's authority to operate the equipment.

IMPORTANT NOTE: To comply with the FCC RF exposure compliance requirements, no modifications to the antenna or the device is permitted. Any change to the antenna or the device could result in the device exceeding the RF exposure requirements and void the user's authority to operate the device.

This device complies with Part 15 of the FCC Rules. Operation is subject to the following two conditions: (1) this device may not cause harmful interference, and (2) this device must accept any interference received, including interference that may cause undesired operation.

APPLICATION TABLE

AMY SPOT[®]
TRAVELER



		MODULES						TRANSMITTERS & ASSOCIATED RECEIVERS						MODULES				
		TV-RECBT	TV5-RECBT	TV5MMP3	AS-TVTX	RIM-CD	TVHH	TVMBP	TVH2	TVBPT	TV-REC	TV5-REC	TV-DREC	TV5-DREC				
		Bluetooth: enabled devices only.	**For use with Bluetooth: enabled devices only.	Media Player	Wireless Audio Link Transmitter	CD/MP3/SD USB Player	Wireless Hand Held Microphone	Wireless Body Pack Transmitter	Wireless Hand Held Microphone	Wireless Body Pack Transmitter	Wireless Receiver	Wireless Receiver	Wireless Receiver	Wireless Receiver				
TV5X																		
TV5i																		
TV8																		
TV10																		
TV-REC																		
TV5-REC																		
TV-DREC																		
TV5-DREC																		

* = Applicable

**For Bluetooth[®] Media Players Only
Does not work with Bluetooth[®] Headsets

Battery Replacement Instructions for TV10, TV8, TV5i & TV5X

Battery Replacement Instructions for TV10, TV8, TV5i & TV5X

Lead-Acid battery

1. ****Make sure the power cable is unplugged and the power switch is in the off position before changing out the batteries**** and only replace with batteries that are the same size and rating as the originals (12V - 2.9 AH Sealed Lead Acid).
2. On the back of the TV10/TV8/and TV5i Galaxy Audio Traveler, you will see large black plate. Remove the screws from the plate. The TV10 has 4 screws around the edge and 2 in the center. The TV8 has 7 screws around the edge plus 2 screws on the sides of the AC input. Notice that these 2 screws are different than the screws around the edge, keep them separate to avoid confusion when re-assembling. The TV5i has four screws around the edge. The battery cover on the TV5X is on the side, has only one screw, and the door slides to remove.



TV10
(x6 Screws)



TV8
(x7 small Screws)
(x2 med. Screws Circled)



TV5i
(x4 Screws)



TV5X
(x1 Screw)

3. Once you remove the plate, carefully pull the battery out far enough to reach the wires. Notice that wires are color coded Red for the Positive (+) terminal and Black for the Negative (-). Carefully pulling on the wire clip, detach the wires from the battery. This is usually easier with needle nose pliers.



4. Pull the battery the rest of the way out. Now carefully slide the new battery in, keeping the wires accessible. Reconnect the wires to the new battery with care to ensure you connect the correct terminals to the correct wire; Red to the Positive terminal and Black to the Negative terminal. When sliding the battery back into the compartment, watch to make sure the wires do not pull away from the battery terminals. If this occurs, gently squeeze the connector with a pair of pliers to get a tighter fit.
5. When replacing the back plate and screws on the TV10, it is easier to replace the center screws first and then the screws around the edge.
6. Although the replacement batteries are charged, it's still suggested to charge the Traveler for at least 12 hours before use.

Note: A good tip to prolonging the life of your battery is to leave the Traveler plugged into AC power when not in use.

This will ensure you always have a fully charged unit and will prevent the batteries from self-discharging. The Traveler has an overcharge circuit so leaving the unit plugged in will not hurt the batteries or the unit.

Thank you for using Galaxy Audio Products.



MAKERS OF THE ORIGINAL
HOT SPOT PERSONAL MONITOR



www.galaxyaudio.com

TRAVELER OWNERS MANUAL



Look for this symbol
on our website and
Build Your Own Traveler

LIMITED THREE YEAR WARRANTY

Please visit galaxyaudio.com for the latest updates

<http://www.galaxyaudio.com/warranty.php>



www.galaxyaudio.com/warranty.php

1-800-369-7768 www.galaxyaudio.com

Please visit galaxyaudio.com for the latest updates

Specifications in this manual are subject to change without notice.

