



Scan for full manual

KT-107S Quick Start Guide

This guide helps you install and use your **KT-107S** for the first time.

Go to www.kramerav.com/downloads/KT-107S to download the latest user manual and check if firmware upgrades are available.

Step 1: Check what's in the box

- ✓ **KT-107S** Touch Panel
- ✓ Tabletop mount
- ✓ On-wall mount unit
- ✓ 1 Quick start guide
- ✓ AC/DC adapter
- ✓ Installation screws
- ✓ Panel mount plate
- ✓ 1 Right-angle OTG USB cable

Step 2: Get to know your KT-107S

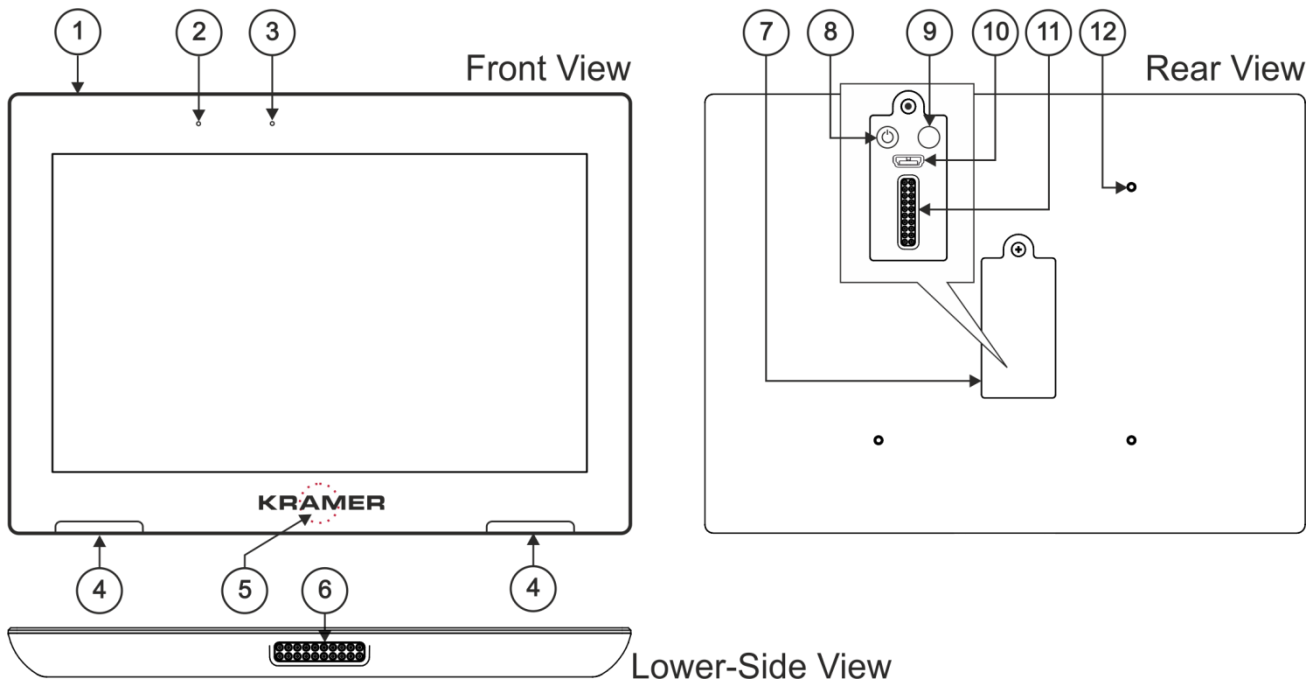

#	Feature	Function
1	Hidden Reset Button	Located on top-side. Insert a pin and hold for a few seconds to reset KT-107S
2	Light Sensor	Automatically adjusts the screen brightness according to the room lighting conditions
3	Activity RGB LED	Lights green when powered, flashes green when charging the battery
4	Speakers	To output the sound
5	Control Button	Touch the Kramer logo area briefly to set the screen to sleep mode or turn it back on. Press and hold (for 1 to 2 seconds) to open the pop-up menu which lets you power down the unit, reboot it or return to the Home-page.
6	Tabletop Mount Connector	For connecting to the tabletop mount
7	Cover	Covers the wall mount connections and power button
8	Power Button	Press to power on the KT-107S . When powered, press briefly to open the pop-up menu and power down the device, reboot it or return to the Home-page. Press and hold to power down the device immediately. This button is also used for firmware upgrade
9	Volume-up Button	Used for firmware upgrade. Press to increase KT-107S speaker volume
10	Micro USB Port	For connecting to an adjacent on-wall USB device and for firmware upgrade



#	Feature	Function
11	Flat Cable Connector	For connecting to the on-wall mount unit
12	Connecting Holes	For connecting to the tabletop mount or the panel mount plate. To prevent potential damage to the Touch Panel , use only Kramer supplied screws and mounts

Step 3: Mounting the KT-107S

Mounting on a table using one of the following options:

Portable Mount: place the tabletop mount on the table. Connected cables remain visible and the table remains intact.

Secure Mount: secure the tabletop mount to the table as follows:

1. Measure the exact location on the surface of the table where you want to install the **KT-107S**.
2. Drill a hole in the table and optionally cut the cable pass-through opening according to the cut-out dimensions defined in the user manual.
3. Secure the tabletop mount to the table using the M5x60 secure screw.
4. Connect the Ethernet port to a PoE-enabled source. Optionally, you can connect the power adapter too (as backup).
5. Replace the appropriate cover and place the **KT-107S** over the tabletop mount (the **Touch Panel** is magnetically held in place), by first inserting the lower part of the **Touch Panel** then carefully laying the **KT-107/KT-107RB** in place.
6. Wait for the Home-page to load and then secure the **KT-107S** to the tabletop mount from the rear side (using 2 M2x4 screws, supplied with the unit).
7. Optionally, lock the tabletop mount with a Kensington locker (not supplied).

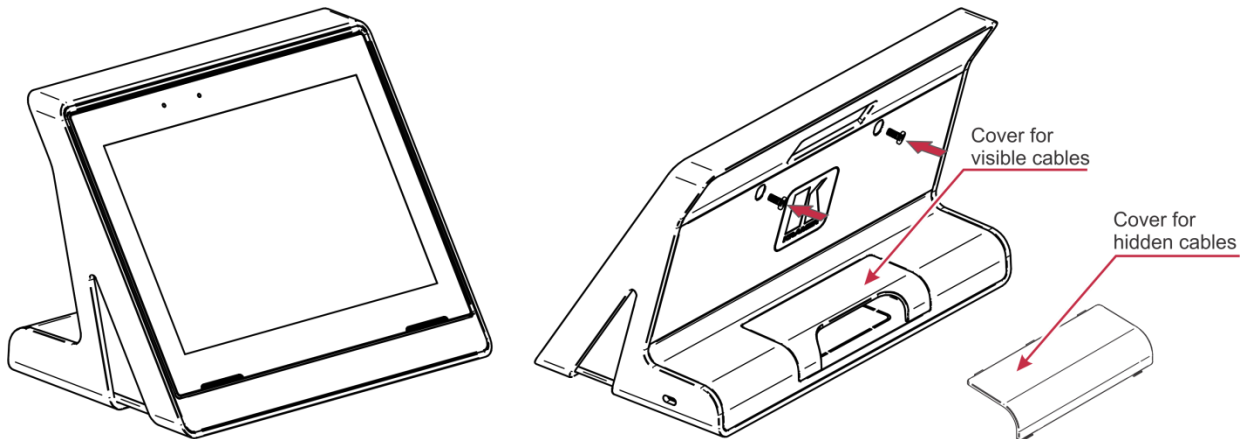

Mounting on the wall:

Before mounting **KT-107S** on a wall, install an in-wall junction box (recommended boxes are listed in the user manual)

1. Attach the on-wall mount unit to the installed junction box (top side up see indication arrows on unit).
Connect Ethernet and/or power cables and optionally, insert the right-angle USB cable (supplied) for connecting to an adjacent external USB device.
2. Screw the 4 wall-mounting screws (supplied) through the screw openings.
The various screw openings fit various types of wall junction boxes.
3. On the rear side of the **KT-107S**, remove the screw cover and the cover and set aside.
4. Attach the panel mount plate to the rear side of the **KT-107S** (using 4 M2x4 screws, supplied).

5. Connect the flat cable from the on-wall mount (attached to the in-wall junction box) to the connector on the rear of **KT-107S**.
6. Hang the **KT-107S** on the wall by sliding the tabs on the attached panel mount plate over the grooves on the on-wall mount unit.

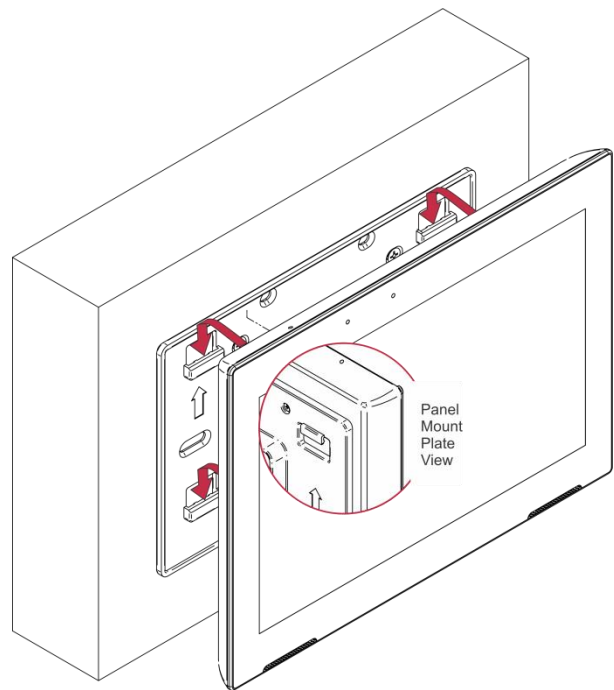

Step 4: Customizing the KT-107S settings

The Settings page is accessible from the Home-page and enables customizing the **KT-107S** settings:

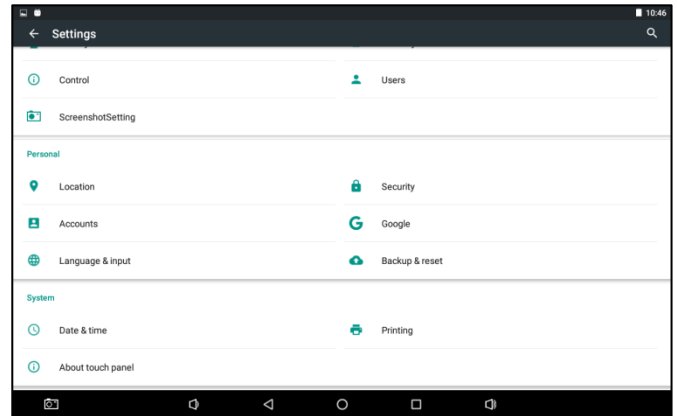
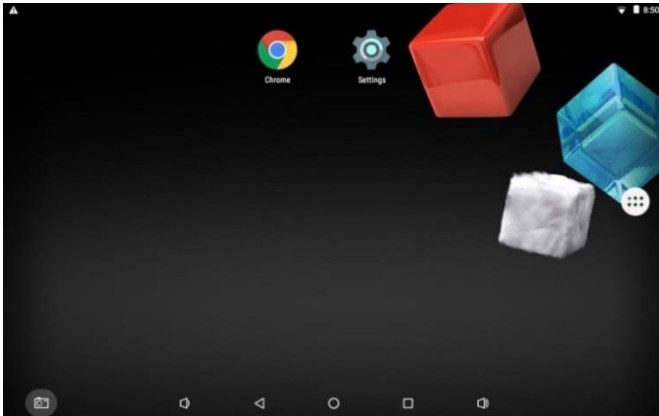

To modify date and time settings:

1. In the Home-page, click **Settings**.
2. Scroll down to the System area and click **Date & time**.
3. Enable **Automatic date & time** to derive the date and time from the Network. When disabled, enter the date and time manually.
4. Select the time format.

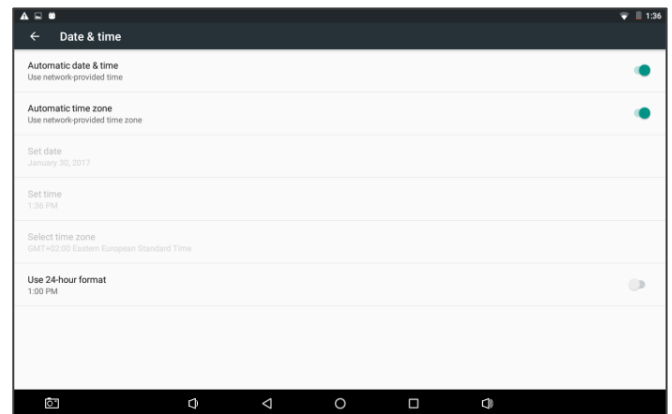

To modify display settings:

1. In the Home-page, click **Settings**.
2. Select **Display**.
3. Set the following (as required):
 - **Brightness**: brightness level, adaptive brightness
 - **Status Bar**: Hide lower and/or top status bar
 - **Auto Sleep**: Sleep timeout.

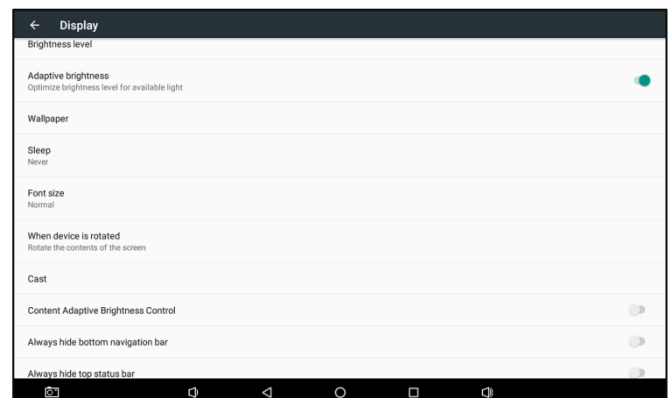

To modify Control button settings:

1. In the Home-page, click **Settings**.
2. Select **Control**.
3. Select **Control button (Kramer Logo touch)**.
4. Enable or disable the control button.

To modify password protection upon Home-page exit:

1. In the Home-page, click **Settings**.
2. Select **Control**
3. Select **Home-page password-protected exit**.
4. Disable or enable.

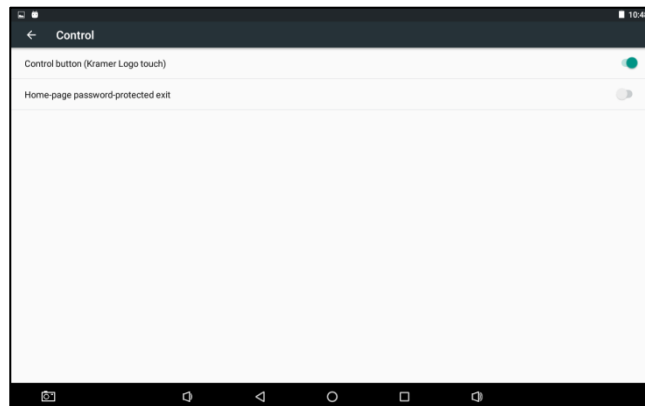

Technical Specifications:

Tabletop Mount Ports:	1 1000/100/10BaseT Ethernet on RJ-45 connector; 1 micro USB 2.0 2-pin terminal block for DC power supply
On-wall Mount Ports:	1 1000/100/10BaseT Ethernet on RJ-45 connector 1 2-pin terminal block connector for DC power supply
CPU Performance:	1.6GHz Quad Core, GPU, 2GB RAM, 16GB Flash
OS Software:	Android 6.0.1
Multi Touch:	10 points, 2-finger gesture
Display:	7" IPS, 1280x800 RGB pixels, 16:10 aspect ratio, ±80° horizontal/vertical viewing angles, 400cd/m2 brightness, 800:1 contrast ratio
Video Format:	Decoding: H.265/HEVC; H.264/AVC; MPEG-1/2/4; DivX 3/4/5/6; MVC; GOOGLE VP8; VC-1; H.263; SORENSON SPARK; ON2 VP6; MOTION JPEG Encoding:H.264/AVC
Ethernet Port:	10/100/1000Mbps PoE LAN
Battery:	Rechargeable, supports up to 3 hours of portable operation
Controls:	Hidden reset button, power button, volume-up button Touch panel status LED: flashes green during charging, green for fully charged
Power Inputs:	Power over Ethernet (complies with IEEE802.3af and IEEE802.3at PoE standards), power supply unit
Power Consumption:	5V DC, 3A
Operating Temperature:	0° to +40°C (32° to 104°F)
Storage Temperature:	-10° to +55°C (14° to 131°F)
Humidity:	10% to 90%, RHL non-condensing
Case Design:	Black body and cover
Dimensions:	Shipping dimensions:22.4cm x 13cm x 20.6cm (8.8" x 5.12" x 8.1"), W, D, H Touch panel: 17.8cm x 1.3cm x 13cm (7" x 0.51" x 5.12"), W, D, H Tabletop mount: 18.5cm x 10.7cm x 12.4cm (7.28" x 4.2" x 4.88"), W, D, H Panel mount plate: 14.6cm x 3.7cm x 9.2cm (5.75" x 1.46" x 3.62"), W, D, H On-wall mount unit: 14.6cm x 1.1cm x 9.1cm (5.75" x 0.43" x 3.58"), W, D, H
Weight:	Shipping weight: 1.8kg (3.97lbs) approx.; Touch panel: 0.37kg (0.8lbs) approx.
Included Accessories:	Power supply unit adapter (5V, 4.0A AC/DC), tabletop mount, on-wall mount unit, panel-mount plate, right-angle OTG USB cable, installation screws
Certifications:	CE/CB, FCC, ROHS, REACH
Mounting Options:	Table top (with tabletop mount unit), on-wall (with mount unit and panel mount plate)
Specifications are subject to change without notice at www.kramerav.com	