

This pdf file includes the following items:

Wall Plate (WP) Series User Manual (P/N: 2900-006018 REV 1)

**WA-1, WA-2, WA-3, WV-2, WAS-1, WAV-1, WX-1,
WB45, WRR, W1145, W4545, WBB, WBR, WR45
WA-21, WA-22, WA-23, WA-20, WV-11, WV-12, WV-20**

Wall Plate (WP) Series User Manual (P/N: 2900-000011 REV 1)

**WXA-1, WVS-1, WVS-2, WAV-2, WXV-1
WA-20N, WA-21N, WA-22N, WA-23N, WV-11N, WV-12N, WV-20N**

Wall Plate (WP) Series Sheet (NEW Versions) (P/N: 2900-006019 REV 7)

**WA-1, WA-2, WA-3, WV-2, WAS-1, WAV-1, WX-1
WB45, WRR, W1145, W4545, WBB, WBR, WR45
WP Frame
Six Frame Adapter for 19" 1U Rack
VPM-2**

Kramer Electronics, Ltd.

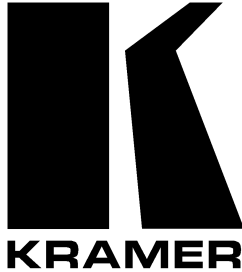

USER MANUAL

Wall Plate (WP) Series

Passive Devices:

**WA-1, WA-2, WA-3, WV-2, WAS-1, WAV-1, WX-1,
WB45, WRR, W1145, W4545, WBB, WBR, WR45**

Active Devices:

WA-21, WA-22, WA-23, WA-20, WV-11, WV-12, WV-20

Contents

1	Introduction	1
2	Getting Started	1
3	Wall Plate (WP) Series	1
4	Passive Devices	2
4.1	Passive Wall Plate Devices	2
4.1.1	WA-3 Dual Mini Headphone to Terminal Block Adapter	3
4.1.2	WA-1 Terminal Blocks Adapter for Balanced Stereo Audio	3
4.1.3	WA-2 Dual RCA to Terminal Block Adapter	4
4.1.4	WV-2 Dual BNC to Terminal Block Adapter	4
4.1.5	WAS-1 Mini Headphone + 4p Connectors to Terminal Block Adapter	5
4.1.6	WAV-1 Mini Headphone + BNC Connectors to Terminal Block Adapter	5
4.1.7	WX-1 HD15F to 6 + 2 Terminal Block Adapter	6
4.2	Passive Connector Module Devices	6
5	Wall Plate Receptacles	7
5.1	WP Frame	7
5.2	VPM-2 XGA Line Driver Wall Plate	8
6	Active Devices	9
6.1	WA-21 Audio TP Transmitter	10
6.2	WA-23 Audio TP Transmitter	11
6.3	WA-20 Audio TP Receiver	12
6.4	WA-22 Audio TP Receiver	13
6.5	WV-11 Video TP Transmitter	14
6.6	WV-12 Video TP Receiver	15
6.7	WV-20 Video Line Amp / DA	16

Figures

Figure 1: WA-3 Dual Mini Headphone to Terminal Block Adapter	3
Figure 2: WA-1 Terminal Blocks Adapter for Balanced Stereo Audio	3
Figure 3: WA-2 Dual RCA to Terminal Block Adapter	4
Figure 4: WV-2 Dual BNC to Terminal Block Adapter	4
Figure 5: WAS-1 Mini Headphone + 4p Connectors to Terminal Block Adapter	5
Figure 6: WAV-1 Mini Headphone + BNC Connectors to Terminal Block Adapter	5
Figure 7: WX-1 HD15F to 6 +2 Terminal Block Adapter	6
Figure 8: WB45 Passive RJ45/BNC Connector Module	7
Figure 9: WRR Double RCA Connector Module Device	7
Figure 10: Attaching up to 3 Passive Wall Plate Devices in a WP Frame	8
Figure 11: Attaching up to 3 Passive Devices in a VPM-2 XGA Line Driver Wall Plate	8
Figure 12: WA-21 Audio TP Transmitter	10
Figure 13: WA-23 Audio TP Transmitter	11
Figure 14: WA-20 Audio TP Receiver	12
Figure 15: WA-22 Audio TP Receiver	13
Figure 16: WV-11 Video TP Transmitter	14
Figure 17: WV-12 Video TP Receiver	15
Figure 18: WV-20 Video Line Amp / DA	16

Tables

Table 1: Passive Wall Plate Device Dimensions	2
Table 2: VPM-2 XGA Line Driver Features and Functions	9
Table 3: VPM-2 XGA Line Driver Wall Plate Dimensions	9
Table 4: Active Wall Plate Device Dimensions	9
Table 5: Active Wall Plate Device Terminal Block PINOUT	10

This addendum adds the following information to the user manual:

	Caution – No operator-serviceable parts inside unit.
	Warning – Use only the Kramer Electronics input power wall adapter that is provided with this unit ¹ .
	Warning – Disconnect power and unplug unit from wall before installing or removing device or servicing unit.

¹ For example: model number AD2512C, part number 2535-000251

1 Introduction

Dedication by Kramer Electronics since 1981, to the development and manufacture of high quality video/audio equipment, makes the Kramer line an integral part of the finest production and presentation facilities in the world. In recent years, Kramer has redesigned and upgraded most of the line, making the best even better! The Kramer line of professional video/audio electronics is one of the most versatile and complete available, and is a true leader in terms of quality, workmanship, price/performance ratio and innovation. In addition to our high quality wall plates, we also offer excellent distribution amplifiers, switchers and matrices, interfaces, processors, remote controllers and computer-related products.

Congratulations on purchasing your Kramer wall plate, which is ideal for the following applications:

- Board, conference and training rooms
- Presentation systems
- Long distance signal distribution and home theater

2 Getting Started

We recommend that you:

- Unpack the equipment carefully and save the original box and packaging materials for possible future shipment
- Review the contents of this user manual

To achieve the best performance you should:

- Connect only good quality connection cables, thus avoiding interference, deterioration in signal quality, and elevated noise levels (often associated with low quality cables)
- Position your Kramer wall plate securely, and in a location that is free from moisture and away from excessive sunlight and dust

3 Wall Plate (WP) Series

The Kramer Wall Plate (WP) series includes adapters / processors for interfacing audio, video, s-Video and XGA, to standards as needed for presentations and other applications. The series consists of:

- 7 passive wall plate devices (see section 4.1) and 7 passive connection modules (see section 4.2) that work with the **WP Frame** and/or the **VPM-2 XGA Line Driver** wall plate
- 7 active wall plate devices (see section 6)

4 Passive Devices

You can attach up to 3 of any of the 14 passive devices—7 wall plate devices (see section 4.1) and/or 7 connector module devices (see section 4.2)—to work with the **WP Frame** and/or the **VPM-2 XGA Line Driver** wall plate.

4.1 Passive Wall Plate Devices

Sections 5.1 and 5.2 respectively, describe how to attach up to 3 passive wall plate devices¹ to the **WP Frame** or to the **VPM-2 XGA Line Driver** wall plate.

The 7 passive wall plate devices include the following:

- **WA-3** (refer to section 4.1.1 on page 3)
- **WA-1** (refer to section 4.1.2 on page 3)
- **WA-2** (refer to section 4.1.3 on page 4)
- **WV-2** (refer to section 4.1.4 on page 4)
- **WAS-1** (refer to section 4.1.5 on page 5)
- **WAV-1** (refer to section 4.1.6 on page 5)
- **WX-1** (refer to section 4.1.7 on page 6)

Table 1 defines the dimensions of a passive wall plate device:

Table 1: Passive Wall Plate Device Dimensions

DIMENSIONS:	5.05 cm x 4.7 cm x 2.34 cm (1.99" x 1.85" x 0.92", W, D, H)
SPACING BETWEEN MOUNTING HOLES:	4.3 cm (1.69") (see Figure 1)
MOUNTING HOLE DIAMETER:	3.2 cm (1.26")

¹ Each passive wall plate device is supplied with two M3x4 screws

4.1.1 WA-3 Dual Mini Headphone to Terminal Block Adapter

The Kramer WA-3 is dual 3.5mm mini headphone connector to a 6-pole terminal block adapter for connecting dual audio stereo channels, as Figure 1 illustrates¹:

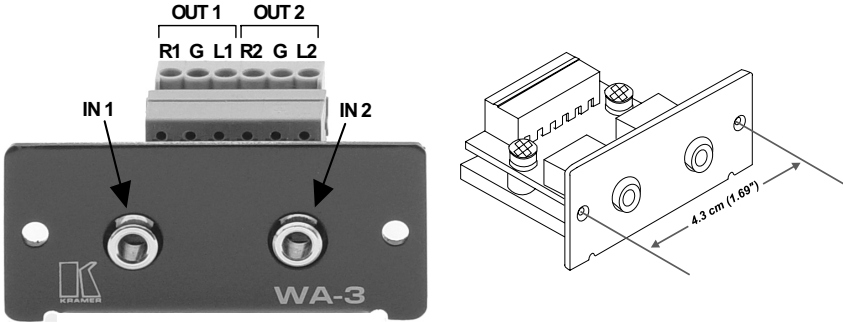

Figure 1: WA-3 Dual Mini Headphone to Terminal Block Adapter

4.1.2 WA-1 Terminal Blocks Adapter for Balanced Stereo Audio

The Kramer WA-1 is a 6-pole terminal block on both sides of the adapter for connecting balanced stereo audio, as Figure 2 illustrates:

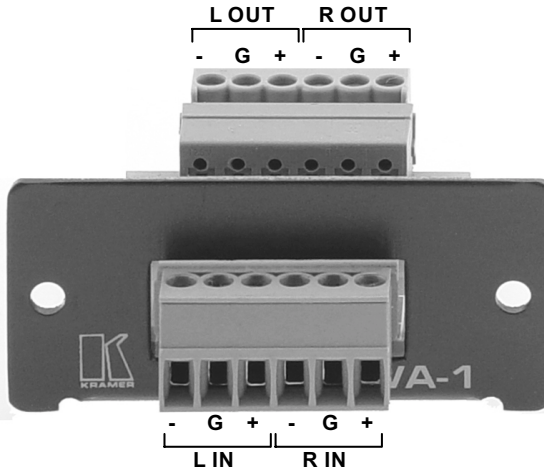

Figure 2: WA-1 Terminal Blocks Adapter for Balanced Stereo Audio

¹ Figure 1 also shows a three-dimensional view of the WA-3, which is similar for each passive wall plate device

4.1.3 WA-2 Dual RCA to Terminal Block Adapter

The Kramer **WA-2** is a dual RCA to 6-pole terminal block adapter for connecting a stereo audio signal (single stereo channel), as Figure 3 illustrates:

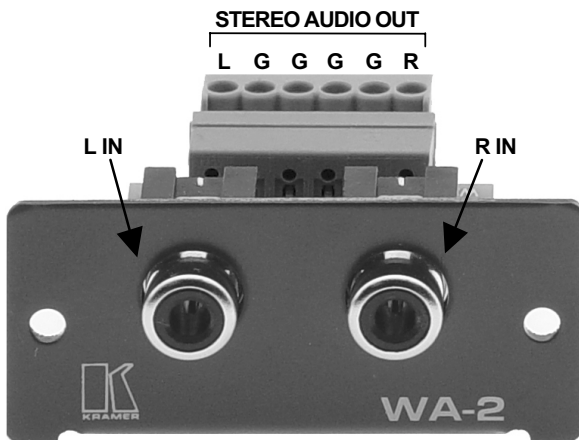

Figure 3: WA-2 Dual RCA to Terminal Block Adapter

4.1.4 WV-2 Dual BNC to Terminal Block Adapter

The Kramer **WV-2** is a dual BNC to 6-pole terminal block adapter for connecting two video sources, as Figure 4 illustrates:

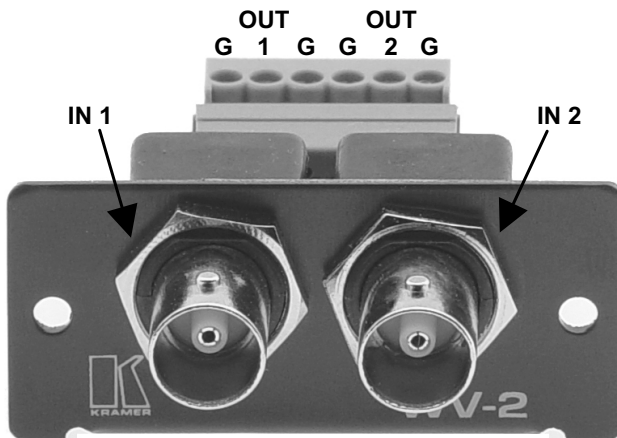

Figure 4: WV-2 Dual BNC to Terminal Block Adapter

4.1.5 WAS-1 Mini Headphone + 4p Connectors to Terminal Block Adapter

The Kramer **WAS-1** is a 3.5 mini headphone connector and an s-Video 4 pin connector to a 6-pole terminal block for connecting s-Video and stereo audio, as Figure 5 illustrates:

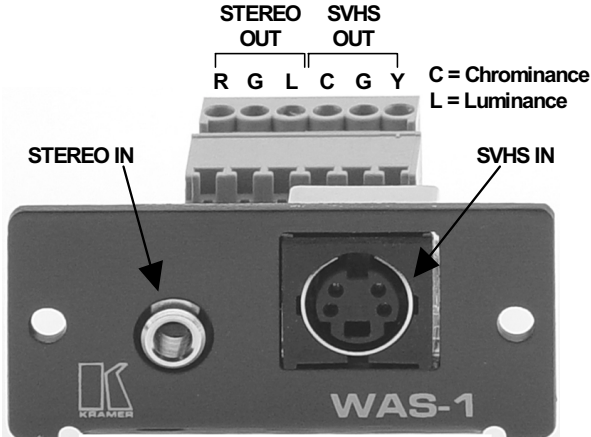

Figure 5: WAS-1 Mini Headphone + 4p Connectors to Terminal Block Adapter

4.1.6 WAV-1 Mini Headphone + BNC Connectors to Terminal Block Adapter

The Kramer **WAV-1** is a 3.5 mm mini headphone and BNC connector to a 6-pole terminal block for connecting video and stereo audio, as Figure 6 illustrates:

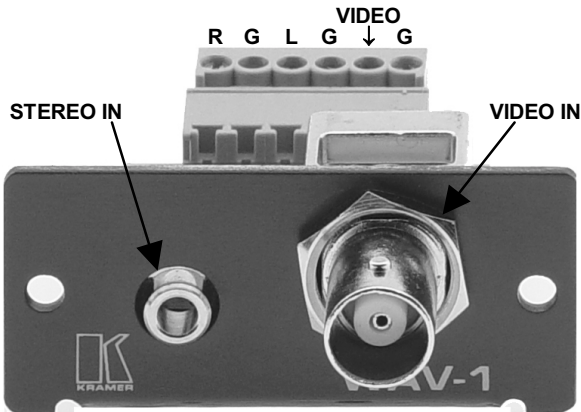

Figure 6: WAV-1 Mini Headphone + BNC Connectors to Terminal Block Adapter

4.1.7 WX-1 HD15F to 6 + 2 Terminal Block Adapter

The Kramer **WX-1** is an HD15F computer (VGA/SVGA/XGA/UXGA) video signal connector to 6 + 2 terminal block connector for connecting a graphics source with an ID Bit Control Switch¹, as Figure 7 illustrates:

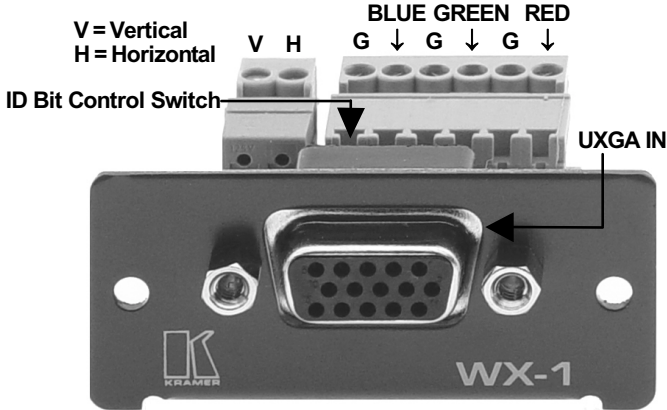

Figure 7: WX-1 HD15F to 6 + 2 Terminal Block Adapter

4.2 Passive Connector Module Devices

The 7 passive connector module devices are also designed to work with the **WP Frame** and/or the **VPM-2 XGA Line Driver** wall plate, as well as the 7 passive wall plate devices (described in section 4.1).

You can attach up to 3 of any 7 passive connector modules in the **WP Frame** or in the **VPM-2 XGA Line Driver** wall plate, as sections 5.1 and 5.2 describe respectively.

The 7 passive connector modules include the following:

- **WB45** (an RJ45/BNC connector module, as Figure 8 illustrates)
- **WRR** (a double RCA connector module, as Figure 9 illustrates)
- **W1145** (an RJ11/RJ45 connector module)
- **W4545** (a double RJ45 connector module)
- **WBB** (a double BNC connector module)
- **WBR** (a BNC/RCA connector module)
- **WR45** (a RJ45/RCA connector module)

¹ The ID Bit Control Switch is connected to the Board behind the front panel, at the position marked in Figure 7

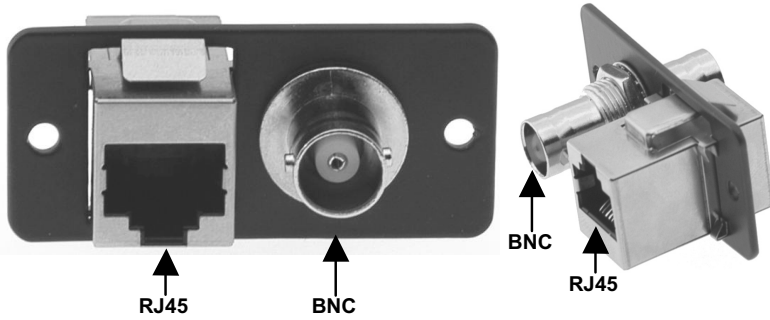

Figure 8: WB45 Passive RJ45/BNC Connector Module

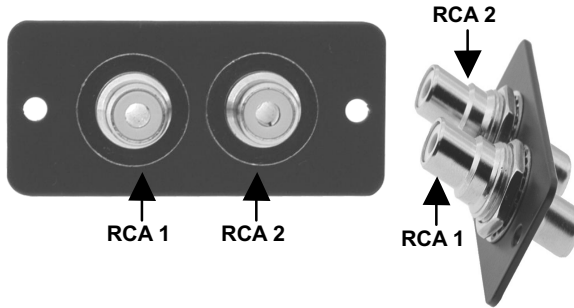

Figure 9: WRR Double RCA Connector Module Device

5 Wall Plate Receptacles

You can attach up to 3 passive wall plates or connector modules in the **WP Frame** or in the **VPM-2 XGA Line Driver** wall plate, as sections 5.1 and 5.2 describe respectively.

5.1 WP Frame

Figure 10 shows how to attach up to 3 passive wall plate devices or connector modules to the **WP FRAME**. If attaching just 1 or 2 passive wall plate devices, cover the empty space(s) with the removable panels that are included with the **WP FRAME**.

Wall Plate Receptacles

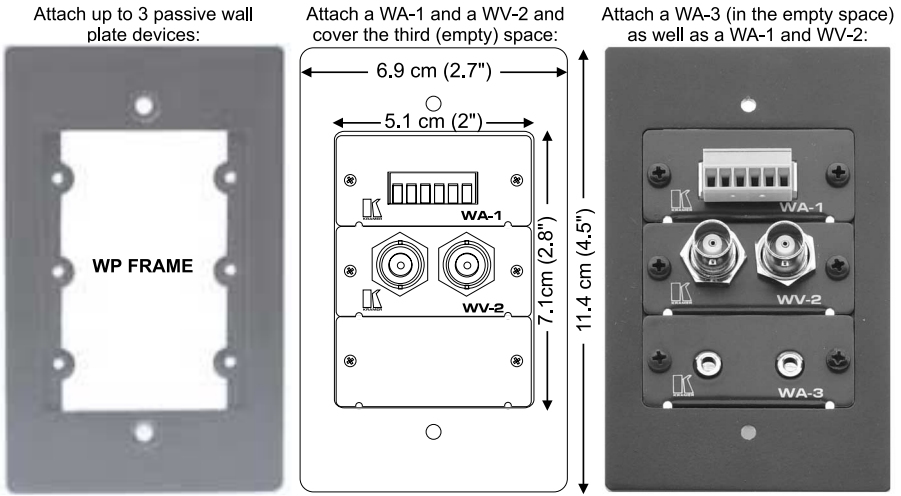

Figure 10: Attaching up to 3 Passive Wall Plate Devices in a WP Frame

5.2 VPM-2 XGA Line Driver Wall Plate

The **VPM-2** wall plate has 3 removable panels designed into the product that can be replaced with up to 3 of the 14 passive devices—7 wall plate devices and/or 7 connector module devices, for example, the **WA-1**, **WV-2** and **WA-3**, as Figure 11 illustrates.

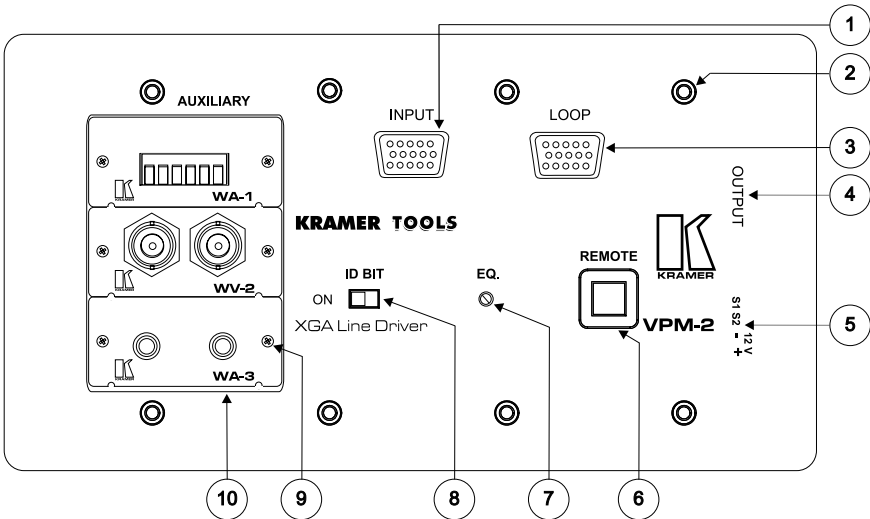

Figure 11: Attaching up to 3 Passive Devices in a VPM-2 XGA Line Driver Wall Plate

Table 2: VPM-2 XGA Line Driver Features and Functions

#	Feature	Function
1	INPUT	VGA/XGA input
2	Mounting Screws (8)	For fastening the VPM-2 in place
3	LOOP	For VGA/XGA looping to increase output availability
4	OUTPUT	VGA/XGA output
5	12V DC	+12V DC connector for powering the unit
6	REMOTE	Button for activating a remote switcher
7	CABLE EQ ¹	Potentiometer for adjusting cable equalization
8	ID BIT Switch	Selects ID BIT when switched ON in the left position (when outputting a VGA signal from a notebook to an external VGA monitor ²)
9	Mounting Screws (2 per passive device)	For fastening each passive device to the VPM-2
10	3 Removable Panels	Can be replaced with up to 3 passive (wall plate or connector module) devices

The **VPM-2** wall plate is available in 2 sizes, one for the US market and one for the European market, as Table 3 defines.

Table 3: VPM-2 XGA Line Driver Wall Plate Dimensions

VPM-2 (US):	21.1 cm x 11.4 cm (8.31" x 4.49", W, D)
VPM-2 (Europe):	18.2 cm x 9.55 cm (7.17" x 3.76", W, D)

6 Active Devices

The 7 active wall plate devices which accompany the **VPM-2** as standalone products, include the following:

- **WA-21** (refer to section 6.1 on page 9)
- **WA-23** (refer to section 6.2 on page 11)
- **WA-20** (refer to section 6.3 on page 12)
- **WA-22** (refer to section 6.4 on page 13)
- **WV-11** (refer to section 6.5 on page 14)
- **WV-12** (refer to section 6.6 on page 15)
- **WV-20** (refer to section 6.7 on page 16)

Table 4 defines the dimensions of an active wall plate device:

Table 4: Active Wall Plate Device Dimensions

6.9 cm x 5.0 cm x 11.4 cm (2.72" x 1.97" x 4.49", W, D, H)
--

Table 5 defines the terminal block PINOUT³ on each active wall plate device.

1 Degradation and VGA/XGA signal loss can result from using long cables (due to stray capacitance), sometimes leading to a total loss of sharpness in high-resolution signals

2 Sometimes notebook computers refuse to output a VGA signal to an external VGA monitor. By setting the ID Bit to ON, (and using pin # 4 on the VGA connector that is normally unused), the notebook will output to an external VGA monitor

3 Each active wall plate device has a sticker with the PINOUT on it

Table 5: Active Wall Plate Device Terminal Block PINOUT

WA-21; WA-23	WA-20; WA-22	WV-11	WV-12	WV-20
<div style="border: 1px solid black; padding: 2px; width: fit-content;"> LINE OUTPUTS + G - + G - R L </div>	<div style="border: 1px solid black; padding: 2px; width: fit-content;"> LINE INPUTS + G - + G - R L </div>	<div style="border: 1px solid black; padding: 2px; width: fit-content;"> LINE OUTPUT + G - </div>	<div style="border: 1px solid black; padding: 2px; width: fit-content;"> LINE INPUT + G - </div>	<div style="border: 1px solid black; padding: 2px; width: fit-content;"> VIDEO OUTPUTS 1 G 2 G </div>

6.1 WA-21 Audio TP Transmitter

The Kramer **WA-21** is a 3.5 mm mini headphone connector to 6-pole terminal block for converting an unbalanced stereo audio signal to balanced audio (or act as a twisted-pair audio transmitter) with left and right audio level controls, as Figure 12 illustrates¹:

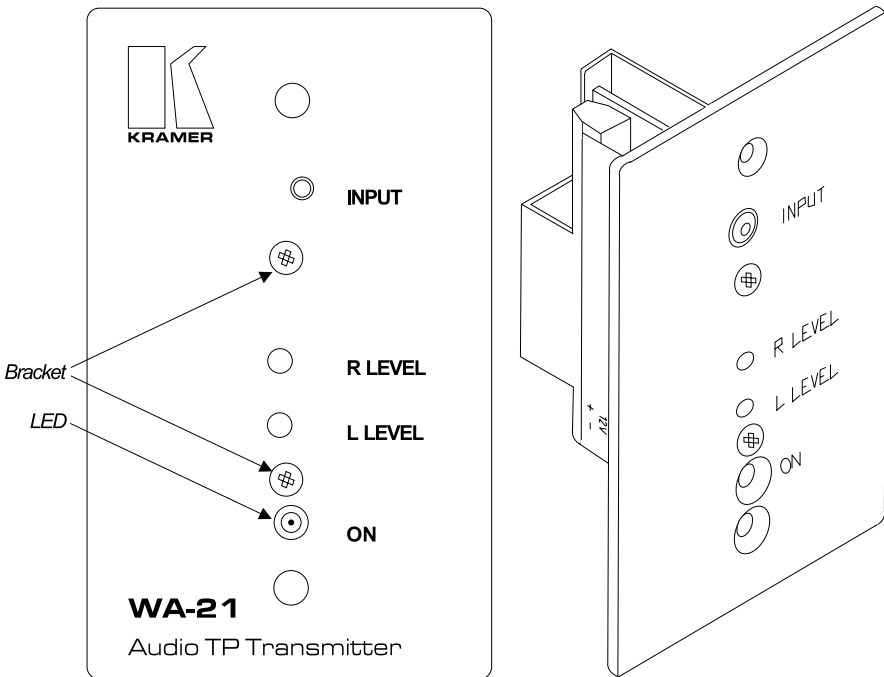

Figure 12: WA-21 Audio TP Transmitter

¹ Figure 12 also shows a three-dimensional view of the WA-21, which is similar for each active wall plate device

6.2 WA-23 Audio TP Transmitter

The Kramer **WA-23** is a dual RCA connector to a 6-pole terminal block for converting an unbalanced stereo audio signal to balanced audio (or act as a twisted-pair audio transmitter) with left and right audio level controls, as Figure 13 illustrates:

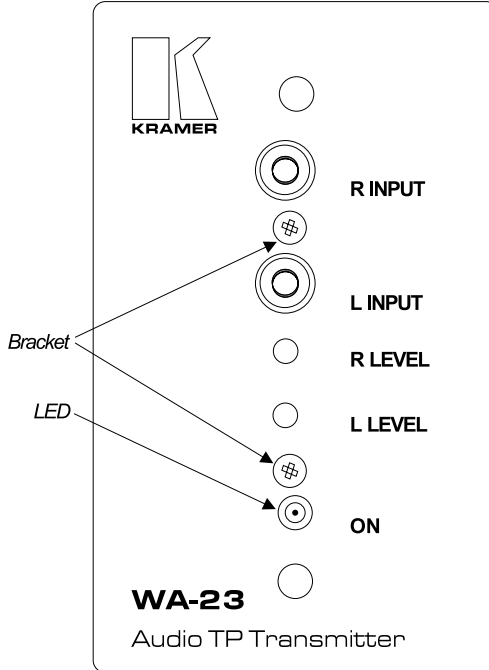

Figure 13: WA-23 Audio TP Transmitter

6.3 WA-20 Audio TP Receiver

The Kramer **WA-20** is a dual RCA connector output to a 6-pole terminal block for converting balanced stereo audio to unbalanced stereo audio (or to act as a twisted pair stereo audio receiver), as Figure 14 illustrates:

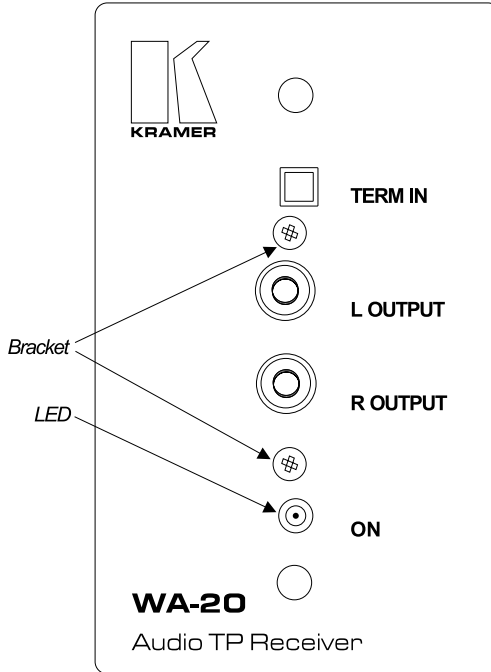

Figure 14: WA-20 Audio TP Receiver

6.4 WA-22 Audio TP Receiver

The Kramer **WA-22** is a 3.5 mm mini headphone connector output to a 6-pole terminal block for converting balanced stereo audio to unbalanced stereo audio (or act as a twisted-pair stereo audio receiver), as Figure 15 illustrates:

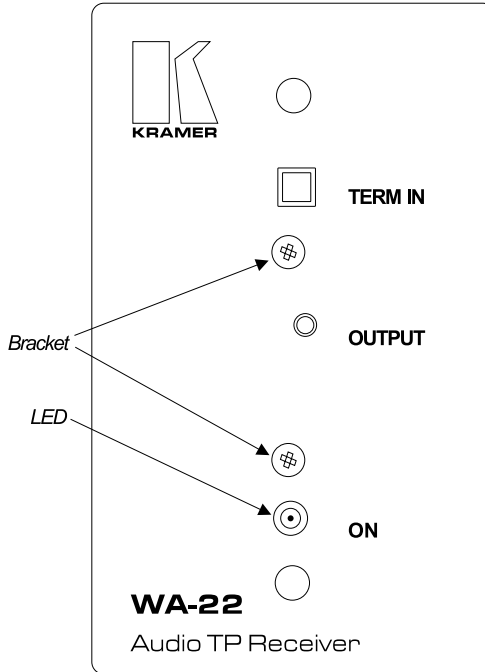

Figure 15: WA-22 Audio TP Receiver

6.5 WV-11 Video TP Transmitter

The Kramer **WV-11** has a BNC connector to a 3-pole terminal block twisted-pair transmitter with video level and EQ controls, enabling high quality video to be sent a distance of up to 1 km over twisted pair cable, as Figure 16 illustrates:

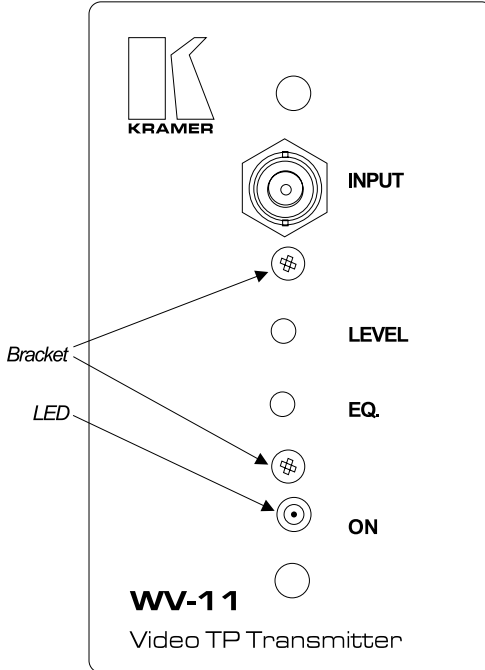

Figure 16: WV-11 Video TP Transmitter

6.6 WV-12 Video TP Receiver

The Kramer **WV-12** provides a video output (on a BNC connector) from a 3-pole terminal block to convert video over twisted-pair (balanced video) to single-ended (unbalanced) video. It provides video level and EQ controls and works in conjunction with the **WV-11**, as Figure 17 illustrates:

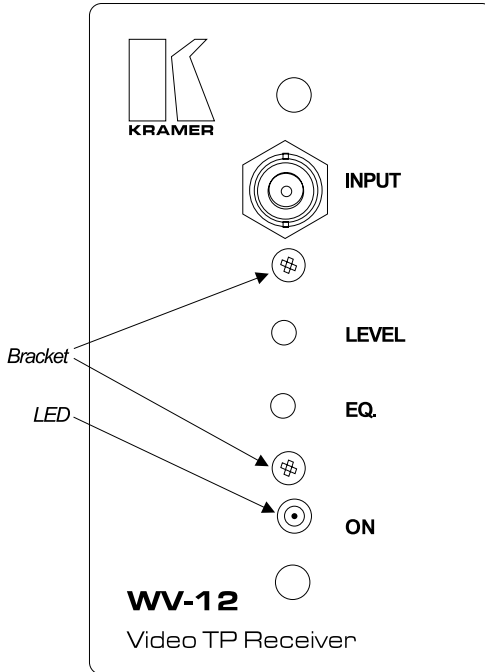

Figure 17: WV-12 Video TP Receiver

6.7 WV-20 Video Line Amp / DA

The Kramer **WV-20** is a 1:2 distribution amplifier and line driver for video on a BNC connector to a 3-pole terminal block connector. Video bandwidth exceeds 400 MHz and quality video can be obtained (when using high quality coax cables) even 300 meters (1000 ft) away. The **WV-20** also provides video level and EQ controls, as Figure 18 illustrates:

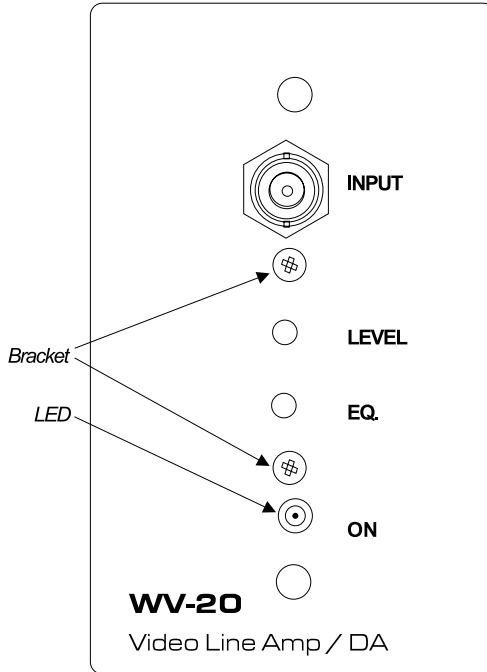

Figure 18: WV-20 Video Line Amp / DA

LIMITED WARRANTY

Kramer Electronics (hereafter *Kramer*) warrants this product free from defects in material and workmanship under the following terms.

HOW LONG IS THE WARRANTY

Labor and parts are warranted for three years from the date of the first customer purchase.

WHO IS PROTECTED?

Only the first purchase customer may enforce this warranty.

WHAT IS COVERED AND WHAT IS NOT COVERED

Except as below, this warranty covers all defects in material or workmanship in this product. The following are not covered by the warranty:

1. Any product which is not distributed by Kramer, or which is not purchased from an authorized Kramer dealer. If you are uncertain as to whether a dealer is authorized, please contact Kramer at one of the agents listed in the web site www.kramerelectronics.com.
2. Any product, on which the serial number has been defaced, modified or removed.
3. Damage, deterioration or malfunction resulting from:
 - i) Accident, misuse, abuse, neglect, fire, water, lightning or other acts of nature
 - ii) Product modification, or failure to follow instructions supplied with the product
 - iii) Repair or attempted repair by anyone not authorized by Kramer
 - iv) Any shipment of the product (claims must be presented to the carrier)
 - v) Removal or installation of the product
 - vi) Any other cause, which does not relate to a product defect
 - vii) Cartons, equipment enclosures, cables or accessories used in conjunction with the product

WHAT WE WILL PAY FOR AND WHAT WE WILL NOT PAY FOR

We will pay labor and material expenses for covered items. We will not pay for the following:

1. Removal or installations charges.
2. Costs of initial technical adjustments (set-up), including adjustment of user controls or programming. These costs are the responsibility of the Kramer dealer from whom the product was purchased.
3. Shipping charges.

HOW YOU CAN GET WARRANTY SERVICE

1. To obtain service on you product, you must take or ship it prepaid to any authorized Kramer service center.
2. Whenever warranty service is required, the original dated invoice (or a copy) must be presented as proof of warranty coverage, and should be included in any shipment of the product. Please also include in any mailing a contact name, company, address, and a description of the problem(s).
3. For the name of the nearest Kramer authorized service center, consult your authorized dealer.

LIMITATION OF IMPLIED WARRANTIES

All implied warranties, including warranties of merchantability and fitness for a particular purpose, are limited in duration to the length of this warranty.

EXCLUSION OF DAMAGES

The liability of Kramer for any effective products is limited to the repair or replacement of the product at our option. Kramer shall not be liable for:

1. Damage to other property caused by defects in this product, damages based upon inconvenience, loss of use of the product, loss of time, commercial loss; or
2. Any other damages, whether incidental, consequential or otherwise. Some countries may not allow limitations on how long an implied warranty lasts and/or do not allow the exclusion or limitation of incidental or consequential damages, so the above limitations and exclusions may not apply to you.

This warranty gives you specific legal rights, and you may also have other rights, which vary from place to place.

NOTE: All products returned to Kramer for service must have prior approval. This may be obtained from your dealer.

This equipment has been tested to determine compliance with the requirements of:

EN-50081:	"Electromagnetic compatibility (EMC); generic emission standard. Part 1: Residential, commercial and light industry"
EN-50082:	"Electromagnetic compatibility (EMC) generic immunity standard. Part 1: Residential, commercial and light industry environment".
CFR-47:	FCC Rules and Regulations: Part 15: "Radio frequency devices Subpart B – Unintentional radiators"

CAUTION!

- ☒ Servicing the machines can only be done by an authorized Kramer technician. Any user who makes changes or modifications to the unit without the expressed approval of the manufacturer will void user authority to operate the equipment.
- ☒ Use the supplied DC power supply to feed power to the machine.
- ☒ Please use recommended interconnection cables to connect the machine to other components.



For the latest information on our products and a list of Kramer distributors, visit our Web site: www.kramerelectronics.com.

**Updates to this user manual may be found at
<http://www.kramerelectronics.com/manuals.html>.**

We welcome your questions, comments and feedback.

Kramer Electronics, Ltd.

3 Am VeOlamo Street. Jerusalem 95463, Israel Tel: (+972-2)-654-4000

Fax: (+972-2)-653-5369, E-mail: info@kramerel.com

P/N: 2900-006018 REV 1

Kramer Electronics, Ltd.

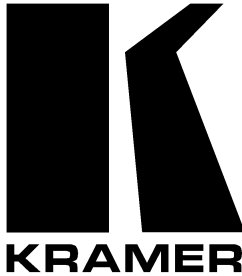

USER MANUAL

Wall Plate (WP) Series

Passive Devices:

WXA-1, WVS-1, WVS-2, WAV-2, WXV-1

Active Devices:

**WA-20N, WA-21N, WA-22N, WA-23N, WV-11N, WV-12N,
WV-20N**

Contents

1	Introduction	1
2	Getting Started	1
3	Overview	1
4	Passive Wall Plate (WP) Devices	2
4.1	WXA-1	2
4.2	WVS-1	3
4.3	WVS-2	4
4.4	WAV-2	5
4.5	WXV-1	6
5	Active Wall Plate (WP) Devices	7
5.1	WA-20N Twisted-Pair Audio Receiver	7
5.2	WA-21N Twisted-Pair Audio Transmitter	8
5.3	WA-22N Twisted-Pair Audio Receiver	9
5.4	WA-23N Twisted-Pair Audio Transmitter	10
5.5	WV-11N Video Twisted-Pair Transmitter	11
5.6	WV-12N Video Twisted-Pair Receiver	12
5.7	WV-20N Video Distribution Amplifier and Line Driver	13

Figures

Figure 1: WXA-1	2
Figure 2: WVS-1	3
Figure 3: WVS-2	4
Figure 4: WAV-2	5
Figure 5: WXV-1	6
Figure 6: WA-20N Twisted-Pair Audio Receiver	7
Figure 7: WA-21N Twisted-Pair Audio Transmitter	8
Figure 8: WA-22N Twisted-Pair Audio Receiver	9
Figure 9: WA-23N Twisted-Pair Audio Transmitter	10
Figure 10: WV-11N Video Twisted-Pair Transmitter	11
Figure 11: WV-12N Video Twisted-Pair Receiver	12
Figure 12: WV-20N Video Distribution Amplifier and Line Driver	13

Tables

Table 1: Dimensions of Wall Plates	1
------------------------------------	---

1 Introduction

Welcome to Kramer Electronics (since 1981): a world of unique, creative and affordable solutions to the infinite range of problems that confront the video, audio and presentation professional on a daily basis. In recent years, we have redesigned and upgraded most of our line, making the best even better! Our 350-plus different models now appear in 8 Groups¹, which are clearly defined by function. Congratulations on purchasing your Kramer wall plate², which is ideal for the following applications: board, conference and training rooms, presentation systems, and long distance signal distribution and home theater.

2 Getting Started

We recommend that you:

- Unpack the equipment carefully and save the original box and packaging materials for possible future shipment
- Review the contents of this user manual
- Use Kramer high performance high resolution cables³

3 Overview

Table 1 defines the wall plate dimensions:

Table 1: Dimensions of Wall Plates

Wall Plate Destined For	Dimensions
Belgium and Germany	8.00cm x 4.08cm x 8.00cm (3.15" x 1.61" x 3.15", W, D, H)
England and Europe ⁴	8.60cm x 4.08cm x 8.60cm (3.39" x 1.61" x 3.39", W, D, H)
United States	6.90cm x 4.08cm x 11.43cm (2.72" x 1.61" x 4.50", W, D, H)

To achieve the best performance you should:

- Connect only good quality connection cables, thus avoiding interference, deterioration in signal quality, and elevated noise levels (often associated with low quality cables)
- Position your Kramer wall plate securely, and in a location that is free from moisture and away from excessive sunlight and dust

1 GROUP 1: Distribution Amplifiers; GROUP 2: Video and Audio Switchers, Matrix Switchers and Controllers; GROUP 3: Video, Audio, VGA/XGA Processors; GROUP 4: Interfaces and Sync Processors; GROUP 5: Twisted Pair Interfaces; GROUP 6: Accessories and Rack Adapters; GROUP 7: Scan Converters and Sealers; and GROUP 8: Cables and Connectors

2 Each wall plate is supplied with two M3x4 screws

3 The complete list of Kramer cables is on our Web site at <http://www.kramerelectronics.com> (click "Cables and Connectors" in the Products section)

4 Except Belgium and Germany

4 Passive Wall Plate (WP) Devices

Sections 4.1 to 4.5 describe the following passive wall plates:

- **WXA-1** (refer to section 4.1)
- **WVS-1** (refer to section 4.2)
- **WVS-2** (refer to section 4.3)
- **WAV-2** (refer to section 4.4)
- **WXV-1** (refer to section 4.5)

4.1 WXA-1

The Kramer **WXA-1** is an HD15F computer (VGA/SVGA/XGA/UXGA) video signal connector and a 3.5mm mini headphone audio connector to 6 + 6 terminal block connectors, as Figure 1 illustrates:

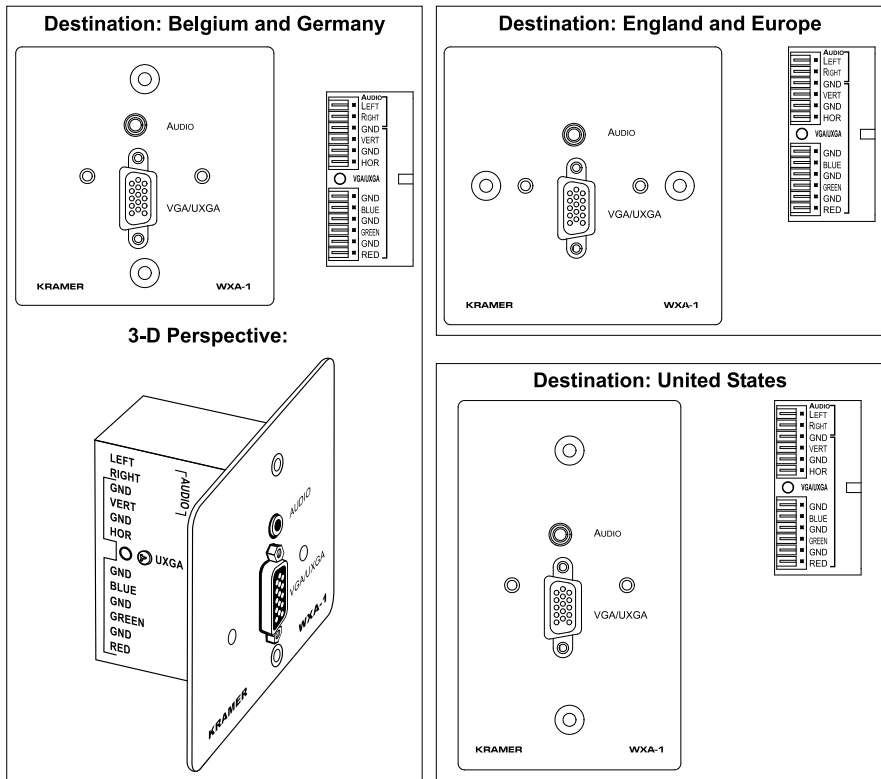

Figure 1: WXA-1

4.2 WVS-1

The Kramer **WVS-1** is a dual RCA stereo audio and s-Video 4p connector to 3-pole + 6-pole terminal block connectors, as Figure 2 illustrates:

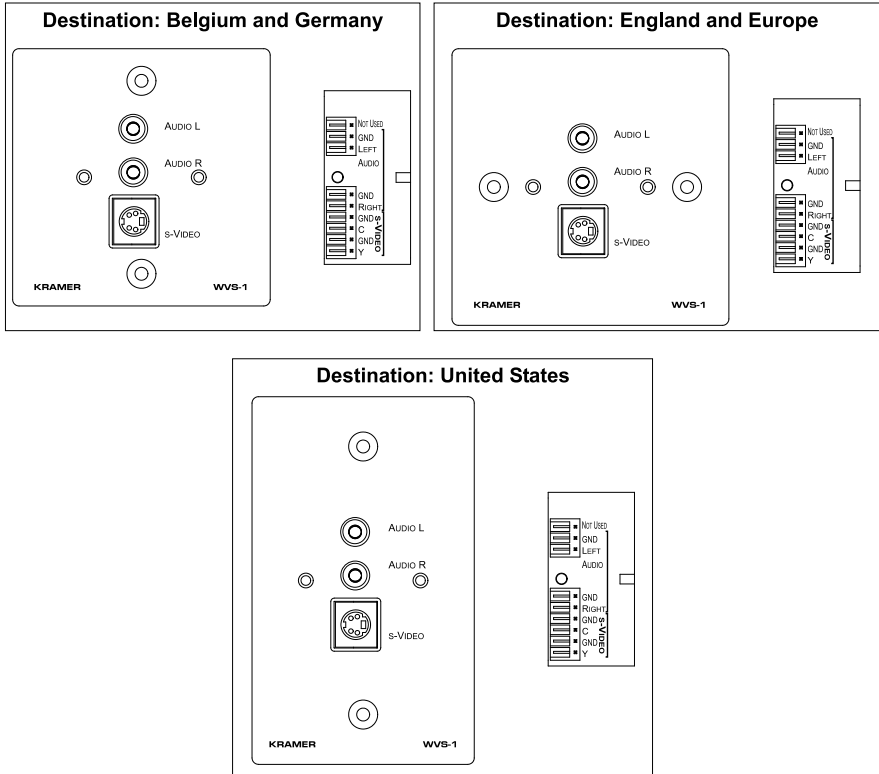

Figure 2: WVS-1

4.3 WVS-2

The Kramer **WVS-2** is a dual 3.5mm mini headphone audio connector, composite video RCA connector and s-Video 4p connector to 6-pole + 6-pole terminal block connectors, as Figure 3 illustrates:

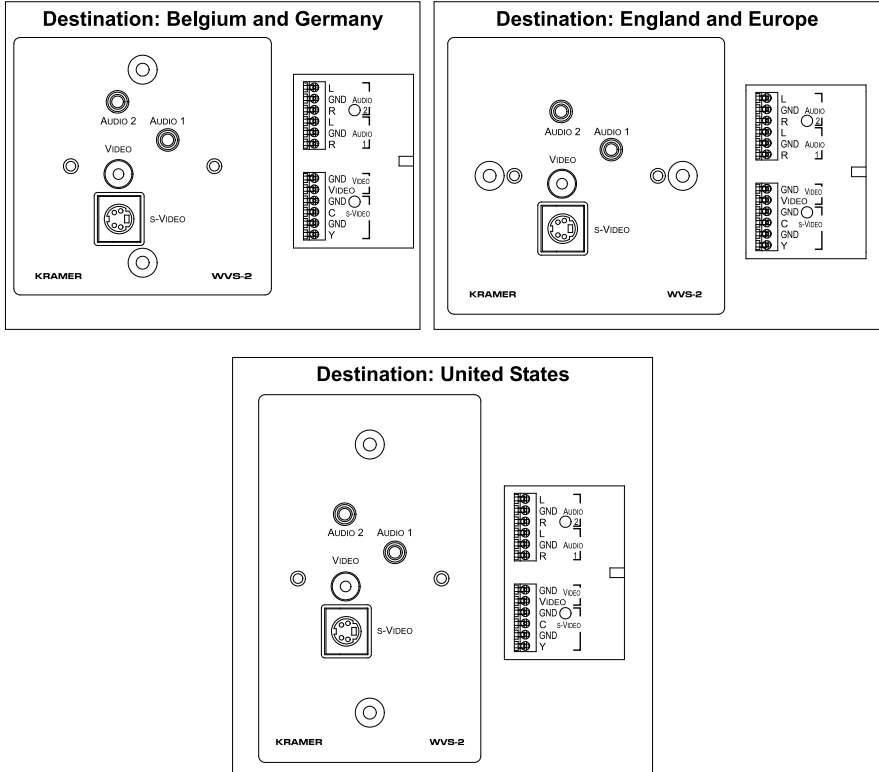

Figure 3: WVS-2

4.4 WAV-2

The Kramer **WAV-2** is a 3.5mm mini headphone audio connector, 3 x composite video RCA connectors to 3-pole + 6-pole terminal block connectors, as Figure 4 illustrates:

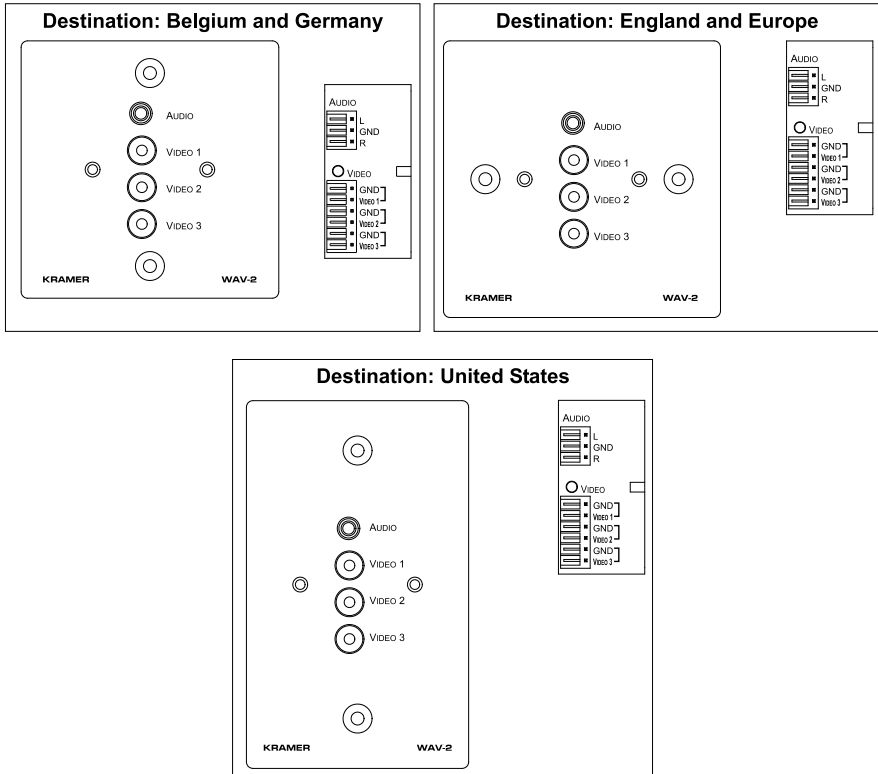

Figure 4: WAV-2

4.5 WXV-1

The Kramer **WXV-1** is a composite video RCA connector and an HD15F computer (VGA/SVGA/XGA/UXGA) video signal connector to 6-pole + 6-pole terminal block connectors, as Figure 5 illustrates:



Figure 5: WXV-1

5 Active Wall Plate (WP) Devices

Sections 5.1 to 5.7 describe the following active wall plates:

- **WA-20N** (refer to section 5.1)
- **WA-21N** (refer to section 5.2)
- **WA-22N** (refer to section 5.3)
- **WA-23N** (refer to section 5.4)
- **WV-11N** (refer to section 5.5)
- **WV-12N** (refer to section 5.6)
- **WV-20N** (refer to section 5.7)

5.1 WA-20N Twisted-Pair Audio Receiver

The Kramer **WA 20N**—a twisted-pair audio receiver—is a dual RCA connector from 6-pole + 2-pole terminal blocks, as Figure 6 illustrates:

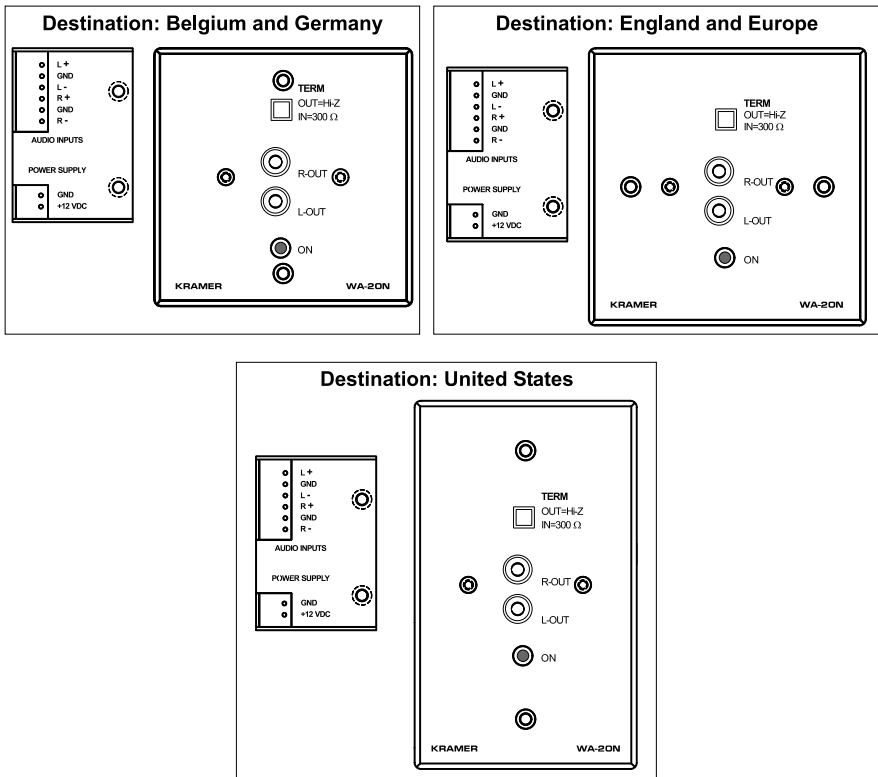

Figure 6: WA-20N Twisted-Pair Audio Receiver

5.2 WA-21N Twisted-Pair Audio Transmitter

The Kramer **WA-21N**—a twisted-pair audio transmitter—is a 3.5mm mini headphone audio connector to 6-pole + 2-pole terminal blocks, with left and right audio level controls, as Figure 7 illustrates:

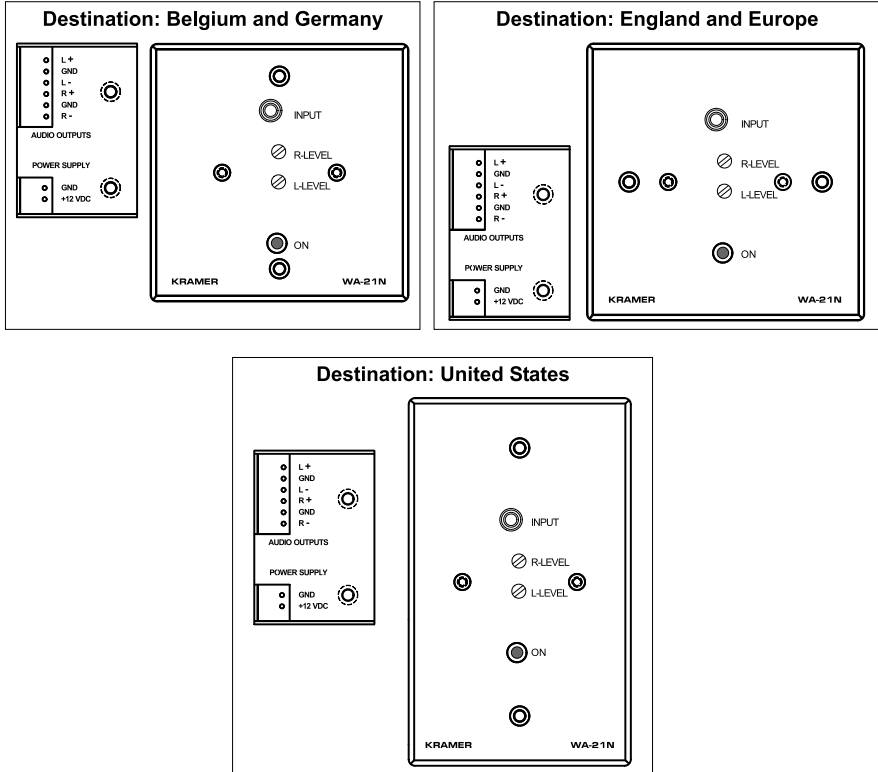

Figure 7: WA-21N Twisted-Pair Audio Transmitter

5.3 WA-22N Twisted-Pair Audio Receiver

The Kramer WA 22N—a twisted-pair audio receiver—is a 3.5mm mini headphone audio connector from 6-pole + 2-pole terminal blocks, with a termination switch, as Figure 8 illustrates:

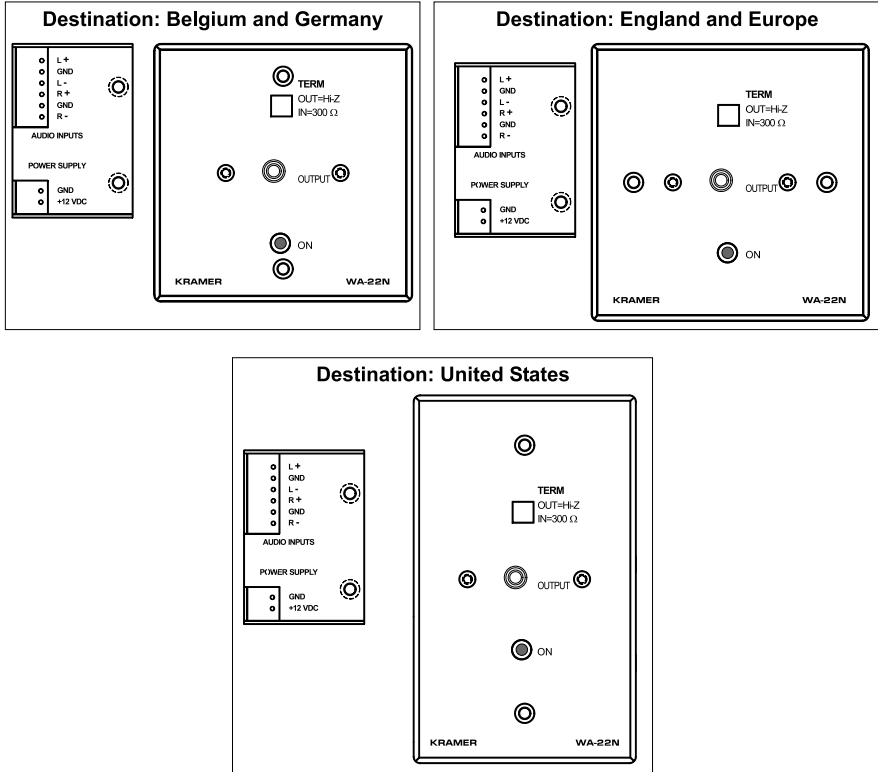

Figure 8: WA-22N Twisted-Pair Audio Receiver

5.4 WA-23N Twisted-Pair Audio Transmitter

The Kramer **WA-23N**—a twisted-pair audio transmitter—is a dual RCA audio connectors to 6-pole + 2-pole terminal blocks with left and right audio level controls, as Figure 9 illustrates:

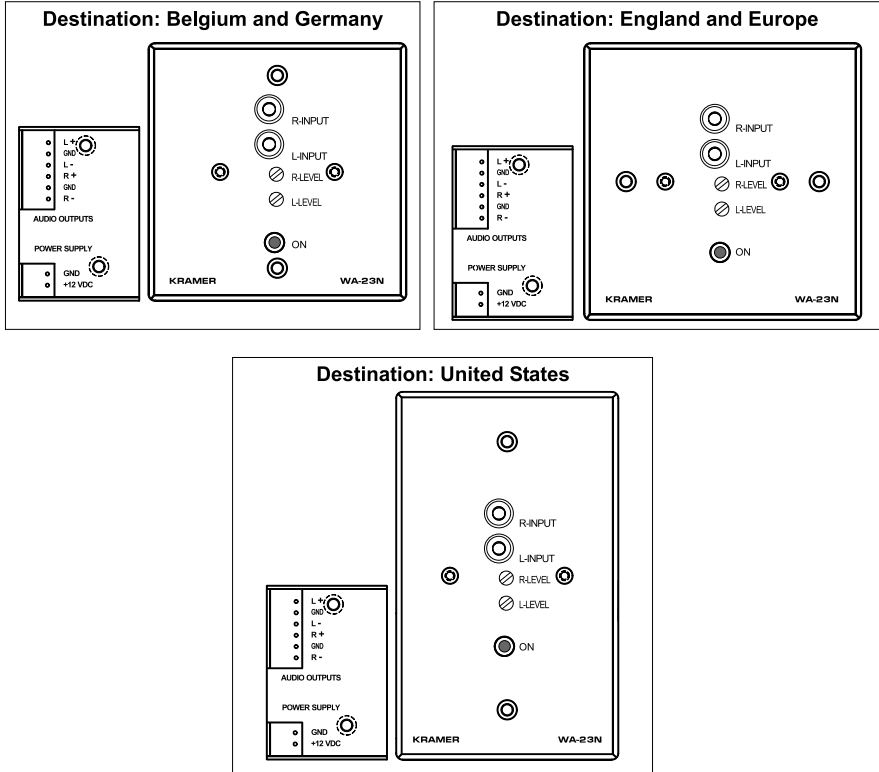

Figure 9: WA-23N Twisted-Pair Audio Transmitter

5.5 WV-11N Video Twisted-Pair Transmitter

The Kramer **WV-11N**—a video twisted-pair transmitter—is a composite video BNC input connector to 3-pole + 2-pole terminal blocks with video level and EQ. controls, as Figure 10 illustrates:

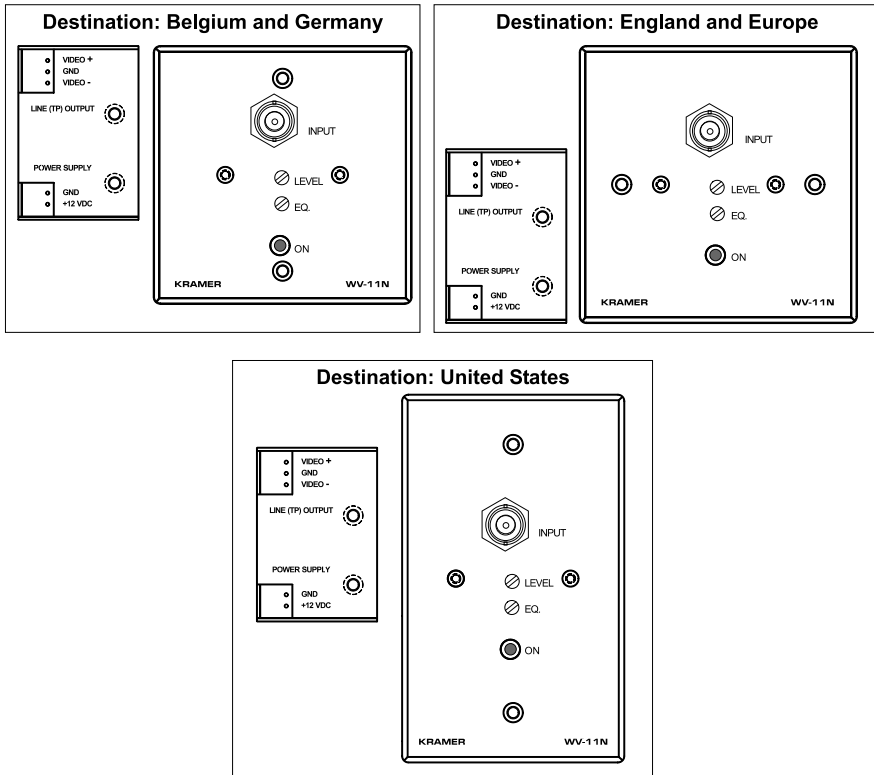

Figure 10: WV-11N Video Twisted-Pair Transmitter

5.6 WV-12N Video Twisted-Pair Receiver

The Kramer **WV-12N**—a video twisted-pair receiver—has a composite video BNC output connector from a 3-pole + 2-pole terminal blocks with video level and EQ. controls, as Figure 11 illustrates:

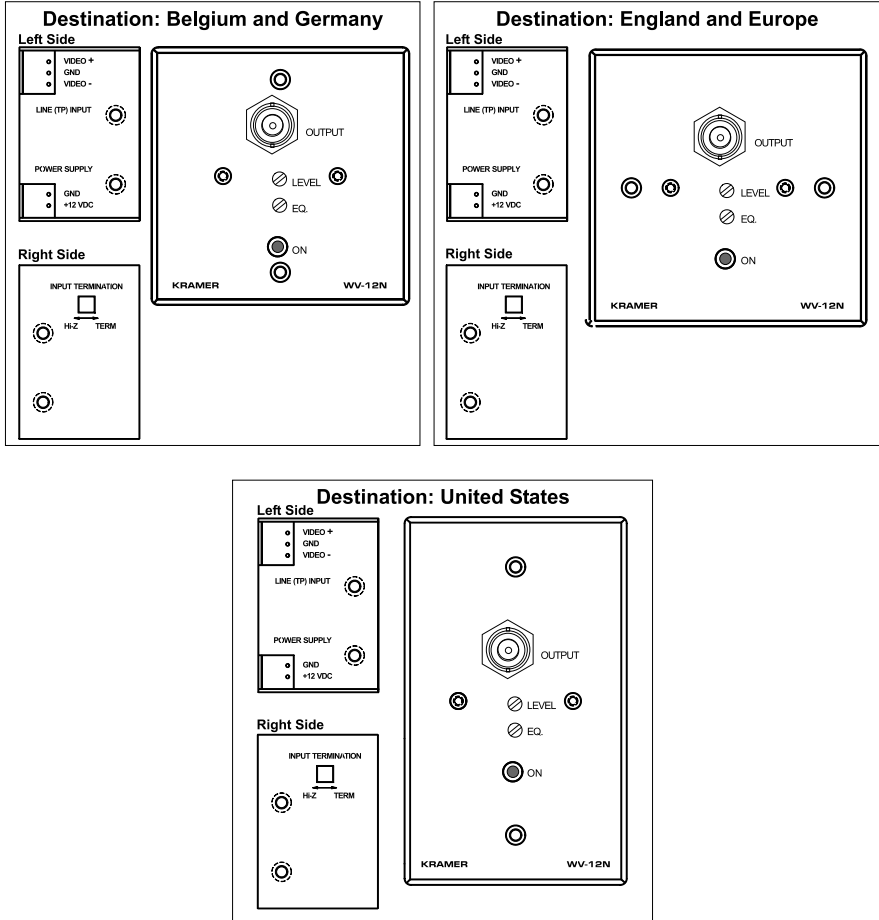

Figure 11: WV-12N Video Twisted-Pair Receiver

5.7 WV-20N Video Distribution Amplifier and Line Driver

The Kramer **WV-20N** is a 1:2 video distribution amplifier and line driver for composite video on a BNC input connector to a 3-pole + 2-pole terminal block connector, with video level and EQ. controls, as Figure 12 illustrates:

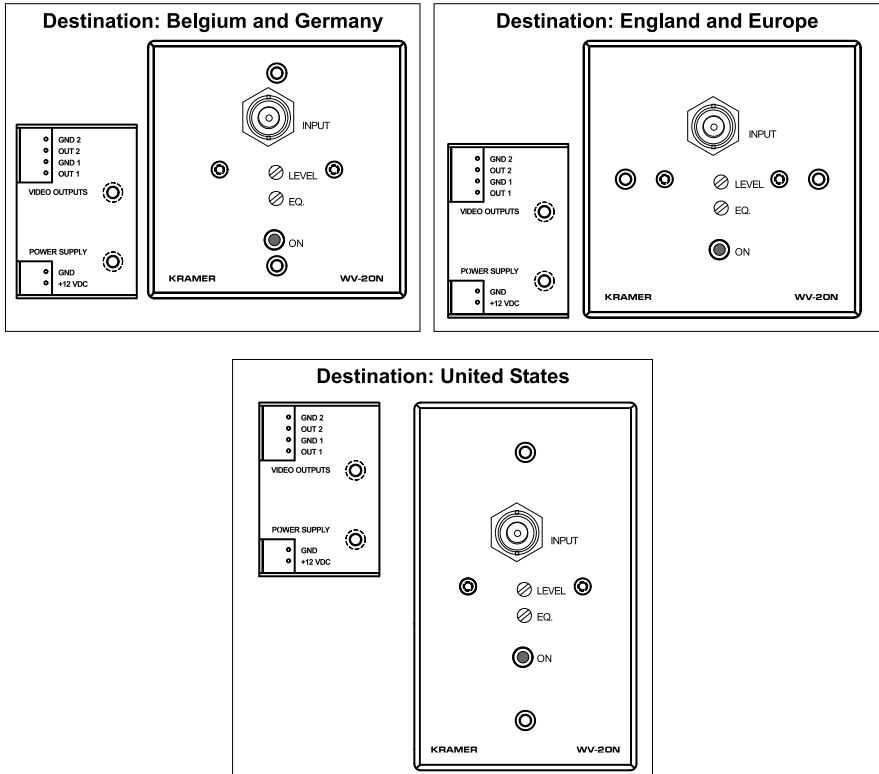

Figure 12: WV-20N Video Distribution Amplifier and Line Driver

LIMITED WARRANTY

Kramer Electronics (hereafter *Kramer*) warrants this product free from defects in material and workmanship under the following terms.

HOW LONG IS THE WARRANTY

Labor and parts are warranted for three years from the date of the first customer purchase.

WHO IS PROTECTED?

Only the first purchase customer may enforce this warranty.

WHAT IS COVERED AND WHAT IS NOT COVERED

Except as below, this warranty covers all defects in material or workmanship in this product. The following are not covered by the warranty:

1. Any product which is not distributed by Kramer, or which is not purchased from an authorized Kramer dealer. If you are uncertain as to whether a dealer is authorized, please contact Kramer at one of the agents listed in the web site www.kramerelectronics.com.
2. Any product, on which the serial number has been defaced, modified or removed.
3. Damage, deterioration or malfunction resulting from:
 - i) Accident, misuse, abuse, neglect, fire, water, lightning or other acts of nature
 - ii) Product modification, or failure to follow instructions supplied with the product
 - iii) Repair or attempted repair by anyone not authorized by Kramer
 - iv) Any shipment of the product (claims must be presented to the carrier)
 - v) Removal or installation of the product
 - vi) Any other cause, which does not relate to a product defect
 - vii) Cartons, equipment enclosures, cables or accessories used in conjunction with the product

WHAT WE WILL PAY FOR AND WHAT WE WILL NOT PAY FOR

We will pay labor and material expenses for covered items. We will not pay for the following:

1. Removal or installations charges.
2. Costs of initial technical adjustments (set-up), including adjustment of user controls or programming. These costs are the responsibility of the Kramer dealer from whom the product was purchased.
3. Shipping charges.

HOW YOU CAN GET WARRANTY SERVICE

1. To obtain service on your product, you must take or ship it prepaid to any authorized Kramer service center.
2. Whenever warranty service is required, the original dated invoice (or a copy) must be presented as proof of warranty coverage, and should be included in any shipment of the product. Please also include in any mailing a contact name, company, address, and a description of the problem(s).
3. For the name of the nearest Kramer authorized service center, consult your authorized dealer.

LIMITATION OF IMPLIED WARRANTIES

All implied warranties, including warranties of merchantability and fitness for a particular purpose, are limited in duration to the length of this warranty.

EXCLUSION OF DAMAGES

The liability of Kramer for any effective products is limited to the repair or replacement of the product at our option. Kramer shall not be liable for:

1. Damage to other property caused by defects in this product, damages based upon inconvenience, loss of use of the product, loss of time, commercial loss; or
2. Any other damages, whether incidental, consequential or otherwise. Some countries may not allow limitations on how long an implied warranty lasts and/or do not allow the exclusion or limitation of incidental or consequential damages, so the above limitations and exclusions may not apply to you.

This warranty gives you specific legal rights, and you may also have other rights, which vary from place to place.

NOTE: All products returned to Kramer for service must have prior approval. This may be obtained from your dealer.

This equipment has been tested to determine compliance with the requirements of:

- EN-50081: "Electromagnetic compatibility (EMC);
generic emission standard.
Part 1: Residential, commercial and light industry"
- EN-50082: "Electromagnetic compatibility (EMC) generic immunity standard.
Part 1: Residential, commercial and light industry environment".
- CFR-47:
FCC Rules and Regulations:
Part 15: "Radio frequency devices
Subpart B – Unintentional radiators"

CAUTION!

- ☒ Servicing the machines can only be done by an authorized Kramer technician. Any user who makes changes or modifications to the unit without the expressed approval of the manufacturer will void user authority to operate the equipment.
- ☒ Use the supplied DC power supply to feed power to the machine.
- ☒ Please use recommended interconnection cables to connect the machine to other components.



For the latest information on our products and a list of Kramer distributors, visit our Web site: www.kramerelectronics.com.

**Updates to this user manual may be found at
<http://www.kramerelectronics.com/manuals.html>.**

We welcome your questions, comments and feedback.



Kramer Electronics, Ltd.

Web site: www.kramerelectronics.com

E-mail: info@kramerel.com

P/N: 2900-00011 REV 1

Passive WP Series (Wall Plate Devices and Connection Modules)

Congratulations on purchasing your Kramer WP Series (passive wall plate device and/or passive connection module), which is ideal for the following applications:

- Board, conference and training rooms
- Presentation systems
- Home theater

You can attach up to 3 of any of the devices from the passive WP Series—wall plate devices and/or connector module devices—to work with the **WP Frame**, and/or the **VPM-2 XGA Line Driver** wall plate. You can also include wall plate/connector module devices in the **TBUS-1**.

Wall Plate Devices (WA-3, WA-1, WA-2, WV-2, WAS-1, WAV-1, WX-1)

The **WA-3** is a dual 3.5mm mini headphone connector to a 6-pole terminal block adapter for connecting dual audio stereo channels:

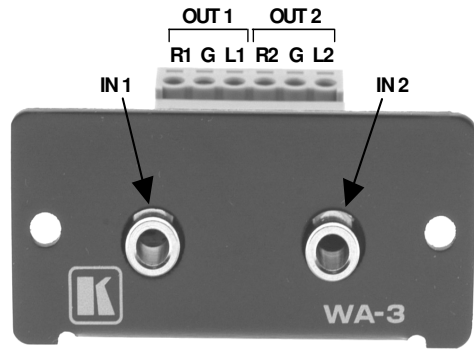

3-D view of the **WA-3**, which is similar for each passive wall plate device:

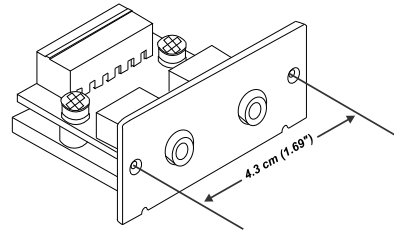

DIMENSIONS: 5.05cm x 4.7cm x 2.34cm
(1.99" x 1.85" x 0.92", W, D, H)
SPACING BETWEEN MOUNTING HOLES:
4.3cm (1.69")

The **WA-1** is a 6-pole terminal block on both sides of the adapter for connecting balanced stereo audio:

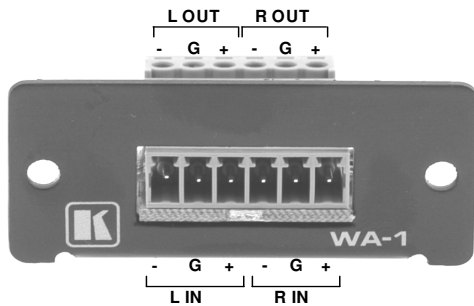

The **WA-2** is a dual RCA to 4-pole terminal block adapter for connecting a stereo audio signal (single stereo channel):

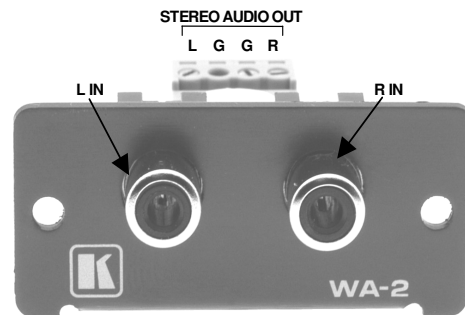

The **WV-2** is a dual BNC to two 3-pole terminal block adapter for connecting two video sources:

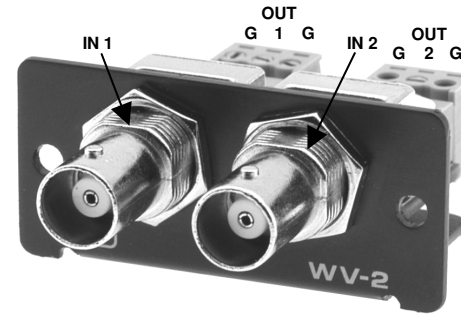

The **WAS-1** is a 3.5 mini headphone connector and an s-Video 4 pin connector to two 3-pole terminal blocks for connecting s-Video and stereo audio:

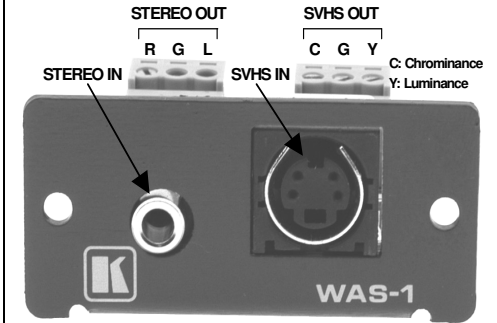

The **WAV-1** is a 3.5mm mini headphone and BNC connector to two 3-pole terminal blocks for connecting video and stereo audio:

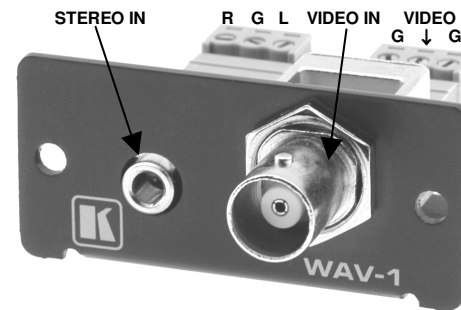

The **WX-1** is an HD15F computer (VGA/SVGA/XGA/UXGA) video signal connector to 6 + 2 terminal block connector for connecting a graphics source. The device includes an ID Bit Control Switch:

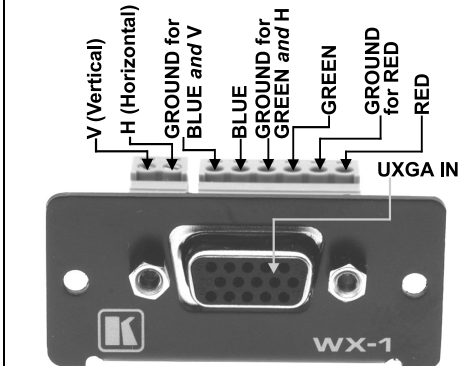

Connector Module Devices (WB45, WRR, W1145, W4545, WBB, WBR, WR45)

The **WB45** is an RJ45/BNC connector module:

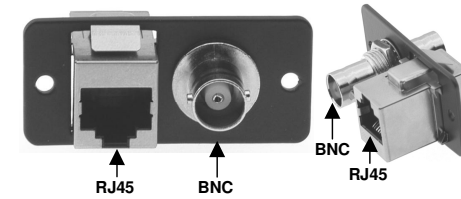

The **WRR** is a double RCA connector module:

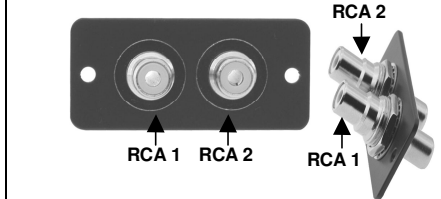

Other connector module devices include the **W1145** (an RJ11/RJ45 connector module), the **W4545** (a double RJ45 connector module), the **WBB** (a double BNC connector module), the **WBR** (a BNC/RCA connector module), and the **WR45** (an RJ45/RCA connector module).

WP Frame (a 3 Slot frame is available in the U.S.; 2 and 4 Slot frames are available in Europe)

You can attach up to 3 of any of the passive devices. If attaching just 1 or 2 passive devices, cover the empty space(s) with the removable panels that are included with the **WP FRAME**.

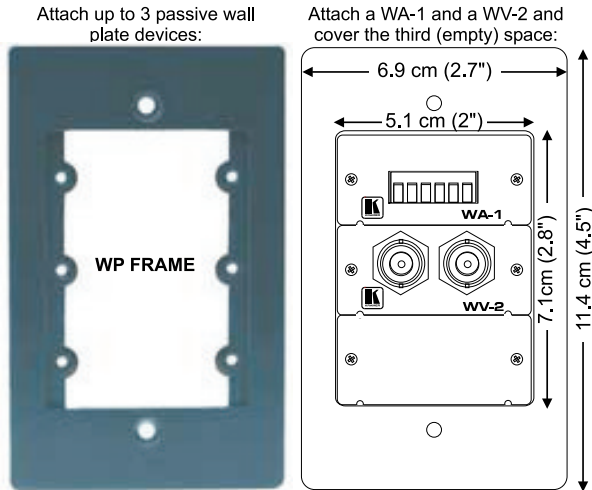

Six Frame Adapter for 19" 1U Rack

You can attach up to 6 of any of the passive devices to the **19" 1U Rack Adapter**

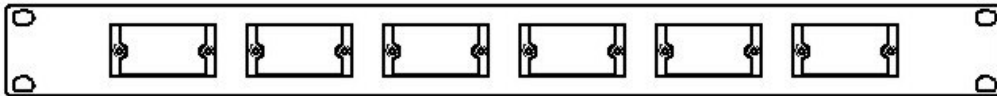

VPM-2 XGA Line Driver Wall Plate

The **VPM-2** wall plate has 3 removable panels designed into the product that can be replaced with up to 3 passive devices. It is available in 2 sizes, one for the US market (21.1cm x 11.4cm (8.31" x 4.49", W, D)) and one for the European market (18.2cm x 9.55cm (7.17" x 3.76", W, D)).

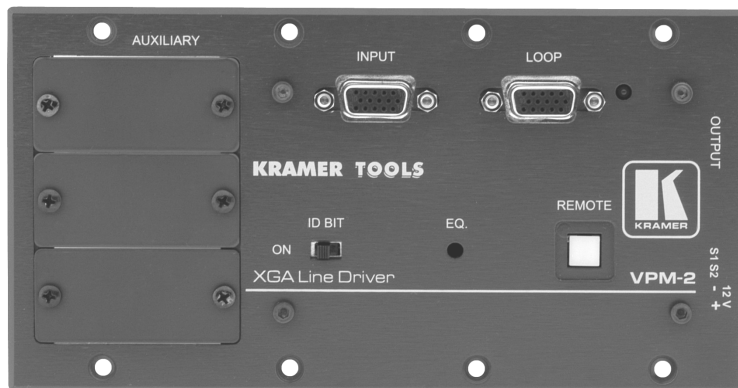

Wall Plate (WP) Series

Passive Wall Plate Devices:

WA-1, WA-2, WA-3, WV-2, WAS-1, WAV-1, WX-1

Passive Connection Modules:

WB45, WRR, W1145, W4545, WBB, WBR, WR45

For the latest information on our products and a list of Kramer distributors, visit our
Web site: www.kramerelectronics.com



Kramer Electronics, Ltd.
Web site: www.kramerelectronics.com
E-mail: info@kramerel.com
P/N: 2900-006019 REV 7