



LaCie 2big Dock Thunderbolt 3 User Manual



Click here to access an up-to-date online version of this document. You will also find the most recent content as well as expandable illustrations, easier navigation, and search capability.

Contents

1	Regulatory Compliance	6
	FCC Declaration of Conformance	6
	FCC Class A Information	6
	FCC Caution	6
	Important Note: FCC Radiation Exposure Statement	6
	Industry Canada	7
	Important Note for mobile device use	7
	Note Importante pour l'utilisation de dispositifs mobiles	7
	Europe – EU Declaration of Conformity	7
	Power source	9
2	Introduction	10
	Box content	10
	Software	10
	• RAID Management	10
	• Backup	10
	Minimum computer system requirements	11
	• Thunderbolt 3	11
	• USB 3.1	11
	Computer hardware requirements	11
	• Minimum free disk space	11
3	Features	12
	Connection	12
	Docking	12
	Expansion	12
	Thunderbolt 3	12
	• Thunderbolt 3 features and support	13
4	System Overview	14
	Storage management	14
	Specifications	14
	• Enclosure dimensions	14
	• Enclosure weight	14
	• Temperature ranges	14
	• Humidity	14
	• Electrical	15
	Views	15
	• Front view	15
	• Rear panel view	15

5	System LEDs	18
	LED locations	18
	LED behavior	18
6	Cables	20
	USB-C	20
	• USB-C protocols	20
	• Easy to connect	21
	Thunderbolt 3 (USB-C) cable	21
	USB 3.1 (USB-C)-to-USB Type A cable	21
7	Connect your LaCie 2big Dock Thunderbolt 3	23
	Windows and Thunderbolt 3	23
	Step 1 - Download and install LaCie RAID Manager	23
	Step 2 - Connect LaCie 2big Dock to your computer	23
	• Thunderbolt 3 connection	24
	• USB 3.1 Gen 1 or 2 connection	24
	• PC or Mac with a USB-C port	24
	• PC or Mac with a USB 3.0 or USB 2.0 port (Type A)	25
	Step 3 - Power connection	25
	Storage format	26
	• Windows	26
8	Operation	27
	Power on	27
	Power off	27
	Power-saving mode	27
	• Power-saving mode: daisy chain	28
	• Power-saving mode: USB 3.0 hub	28
	• Power-saving mode: managed by the PC/Mac	28
	• Receiving power	28
	Short push	29
	• Short push and RAID synchronization/initialization	29
	Long push	29
	Removing the Thunderbolt cable during operation	29
	Quiet operation and heat management	29
	Position and stacking	30
9	Docking Features	31
	USH-II Secure Digital Extended Capacity (SDXC) Memory Card Reader	31
	• Reading an SD memory card	31
	• Removing an SD memory card	31
	CompactFlash (CF) Revision 6.0 Type I (UDMA 7) Memory Card Reader	32

- Reading a CF memory card 32
- Removing a CF memory card 32
- USB 3.0 Hub** **32**
- Connecting a device to the USB 3.0 hub 32
- Disconnecting a device from the USB 3.0 hub 33

10 Expansion Port **34**

- DisplayPort 1.2** **34**
- Connecting the DisplayPort 34
- Disconnecting the DisplayPort 35

11 Daisy Chain and Power Delivery **36**

- Daisy chain Thunderbolt 3 devices 36
- How to daisy chain 36
- Daisy chain: power-saving mode 37
- Power delivery 37

12 Manage RAID **38**

- Sign in to LaCie RAID Manager** **38**
- Administrator users 38
- Standard users 38
- LaCie RAID Manager Navigation** **38**
- Device** **39**
- Scan for new devices 40
- Overview** **40**
- View array details 40
- Delete an array 40
- Create an array 41
- Rescan for devices 42
- Array** **43**
- View array details 43
- Manage array 43
 - Delete array 43
- View disk details 43
- Device settings** **44**
- Change device name 44
- Register your device 45
- View device details 45
- App settings** **45**
- Change language settings 45
- Change autostart setting 45
- Notifications** **45**
- Download log 46
- Clear notification entries 46

- Email settings 46
 - Custom server 46
- Updates 47
 - Check for updates 47
 - Use system proxy settings 47
- Recent notifications 48

13 .Hard Drive Maintenance 49

- Precautions 49
- Replacing a hard drive..... 49
- LaCie 2big Dock enclosure: non-serviceable components 53

14 .Formatting and Partitioning 54

- About file system formats 54
- Formatting instructions 55
 - Mac 55
 - OS X version 10.11 or later 55
 - OS X version 10.9 to 10.10 55
 - Windows 55

15 Frequently Asked Questions 57

- All users 57
 - Problem: My file transfers are too slow. 57
 - Problem: I connected LaCie 2big Dock to my computer but it does not power on and I cannot see the device in LaCie RAID Manager. 57
 - Problem: I want to change the RAID level..... 58
 - Problem: I disconnected my computer from the LaCie 2big Dock during RAID synchronization or initialization. 58
 - Problem: I have a USB-C hard drive that I want to add to the Thunderbolt 3 daisy chain..... 58
 - Problem: I must password protect and/or encrypt my hard drive..... 58
 - Problem: I'm receiving file transfer error messages. 59
 - Problem: DisplayPort to HDMI display does not work. 59
- Mac 59
 - Problem: The drive icon does not appear on my desktop. 59
- Windows 60
 - Problem: The drive icon doesn't appear in Computer. 60

Regulatory Compliance

FCC Declaration of Conformance

This device complies with Part 15 of the FCC Rules. Operation is subject to the following two conditions: (1) this device may not cause harmful interference, and (2) this device must accept any interference received, including interference that may cause undesired operation.

FCC Class A Information

This equipment has been tested and found to comply with the limits for a Class A digital device, pursuant to Part 15 of the FCC Rules. These limits are designed to provide reasonable protection against harmful interference in a residential installation. This equipment generates, uses and can radiate radio frequency energy and, if not installed and used in accordance with the instructions, may cause harmful interference to radio communications. However, there is no guarantee that interference will not occur in a particular installation.

If this equipment does cause harmful interference to radio or television reception, which can be determined by turning the equipment off and on, the user is encouraged to try to correct the interference by one of the following measures:

- Reorient or relocate the receiving antenna.
- Increase the separation between the equipment and receiver.
- Connect the equipment into an outlet on a circuit different from that to which the receiver is connected.
- Consult the dealer or an experienced radio/TV technician for help.

This device complies with Part 15 of the FCC Rules. Operation is subject to the following two conditions: (1) This device may not cause harmful interference, and (2) this device must accept any interference received, including interference that may cause undesired operation.

FCC Caution

Any changes or modifications not expressly approved by the party responsible for compliance could void the user's authority to operate this equipment.

Important Note: FCC Radiation Exposure Statement

This equipment complies with FCC radiation exposure limits set forth for an uncontrolled environment. This equipment should be installed and operated with minimum distance 20cm between the radiator and your body. This transmitter must not be co-located or operating in conjunction with any other antenna or

transmitter. The availability of some specific channels and/or operational frequency bands are country dependent and are firmware programmed at the factory to match the intended destination. The firmware setting is not accessible by the end user.

Industry Canada

This device complies with RSS-210 of the Industry Canada Rules. Operation is subject to the following two conditions: (1) This device may not cause harmful interference, and (2) this device must accept any interference received, including interference that may cause undesired operation.

Ce dispositif est conforme à la norme CNR-210 d'Industrie Canada applicable aux appareils radio exempts de licence. Son fonctionnement est sujet aux deux conditions suivantes: (1) le dispositif ne doit pas produire de brouillage préjudiciable, et (2) ce dispositif doit accepter tout brouillage reçu, y compris un brouillage susceptible de provoquer un fonctionnement indésirable.

Important Note for mobile device use

Radiation Exposure Statement: This equipment complies with IC radiation exposure limits set forth for an uncontrolled environment. This equipment should be installed and operated with minimum distance 20cm between the radiator & your body.

Note Importante pour l'utilisation de dispositifs mobiles

Déclaration d'exposition aux radiations:

Cet équipement est conforme aux limites d'exposition aux rayonnements IC établies pour un environnement non contrôlé. Cet équipement doit être installé et utilisé avec un minimum de 20 cm de distance entre la source de rayonnement et votre corps.

Europe – EU Declaration of Conformity

This device complies with the essential requirements of the EMC Directive 2004/108/EC. The following test methods have been applied in order to prove presumption of conformity with the essential requirements of the EMC Directive 2004/108/EC:

- EN 60950-1:2006/AC:2011: Information technology equipment - Safety - Part 1: General requirements
- EN 55022: 2010/AC:2011: Information technology equipment - Radio disturbance characteristics
 - Limits and methods of measurement
- EN 55024: 2010: Information technology equipment - Immunity characteristics - Limits and methods of measurement

Česky [Czech]	LaCie tímto prohlašuje, že tento direct attached storage device je ve shodě se základními požadavky a dalšími příslušnými ustanoveními směrnice 2004/5/ES.
Dansk [Danish]	Undertegnede LaCie erklærer herved, at følgende udstyr direct attached storage device overholder de væsentlige krav og øvrige relevante krav i direktiv 2004/5/EF.
Deutsch [German]	Hiermit erklärt LaCie, dass sich das Gerät direct attached storage device in Übereinstimmung mit den grundlegenden Anforderungen und den übrigen einschlägigen Bestimmungen der Richtlinie 2004/5/EG befindet.
Eesti [Estonian]	Käesolevaga kinnitab LaCie seadme direct attached storage device vastavust direktiivi 2004/5/EÜ põhinõuetele ja nimetatud direktiivist tulenevatele teistele asjakohastele sätetele.
English	Hereby, LaCie, declares that this direct attached storage device is in compliance with the essential requirements and other relevant provisions of Directive 2004/5/EC.
Español [Spanish]	Por medio de la presente LaCie declara que el direct attached storage device cumple con los requisitos esenciales y cualesquiera otras disposiciones aplicables o exigibles de la Directiva 2004/5/CE.
Ελληνική [Greek]	ΜΕ ΤΗΝ ΠΑΡΟΥΣΑ LaCie ΔΗΛΩΝΕΙ direct attached storage device ΣΥΜΜΟΡΦΩΝΕΤΑΙ ΠΡΟΣ ΤΙΣ ΟΥΣΙΩΔΕΙΣ ΑΠΑΙΤΗΣΕΙΣ ΚΑΙ ΤΙΣ ΛΟΙΠΕΣ ΣΧΕΤΙΚΕΣ ΔΙΑΤΑΞΕΙΣ ΤΗΣ ΟΔΗΓΙΑΣ 2004/5/ΕΚ.
Français [French]	Par la présente LaCie déclare que l'appareil direct attached storage device est conforme aux exigences essentielles et aux autres dispositions pertinentes de la directive 2004/5/CE.
Italiano [Italian]	Con la presente LaCie dichiara che questo direct attached storage device è conforme ai requisiti essenziali ed alle altre disposizioni pertinenti stabilite dalla direttiva 2004/5/CE.
Latviski [Latvian]	Ar šo LaCie deklarē, ka direct attached storage device atbilst Direktīvas 2004/104/EK būtiskajām prasībām un citiem ar to saistītajiem noteikumiem.
Lietuvių [Lithuanian]	Šiuo LaCie deklaruoja, kad šis direct attached storage device atitinka esminius reikalavimus ir kitas 2004/104/EB Direktyvos nuostatas.
Nederlands [Dutch]	Hierbij verklaart LaCie dat het toestel direct attached storage device in overeenstemming is met de essentiële eisen en de andere relevante bepalingen van richtlijn 2004/104/EG.
Malti [Maltese]	Hawnhekk, LaCie, jiddikjara li dan direct attached storage device jikkonforma mal-ħtiġijiet essenzjali u ma provvedimenti oħrajn rilevanti li hemm fid-Dirrettiva 2004/104/EC.
Magyar [Hungarian]	Alulírott, LaCie nyilatkozom, hogy a direct attached storage device megfelel a vonatkozó alapvető követelményeknek és az 2004/104/EC irányelv egyéb előírásainak.
Polski [Polish]	Niniejszym LaCie oświadcza, że direct attached storage device jest zgodny z zasadniczymi wymogami oraz pozostałymi stosownymi postanowieniami Dyrektywy 2004/104/EC.
Português [Portuguese]	LaCie declara que este direct attached storage device está conforme com os requisitos essenciais e outras disposições da Directiva 2004/104/CE.

Slovensko [Slovenian]	LaCie izjavlja, da je at direct attached storage device v skladu z bistvenimi zahtevami in ostalimi relevantnimi določili direktive 2004/104/ES.
Slovensky [Slovak]	LaCie týmto vyhlasuje, že direct attached storage device spĺňa základné požiadavky a všetky príslušné ustanovenia Smernice 2004/104/ES.
Suomi [Finnish]	LaCie vakuuttaa täten että direct attached storage device tyyppinen laite on direktiivin 2004/104/EY oleellisten vaatimusten ja sitä koskevien direktiivin muiden ehtojen mukainen.
Svenska [Swedish]	Härmed intygar LaCie att denna direct attached storage device står i överensstämmelse med de väsentliga egenskapskrav och övriga relevanta bestämmelser som framgår av direktiv 2004/104/EG.

Power source



Caution: Use the product with the provided power cable only.



Note: To protect your data, always follow the safe removal procedures for your operating system when disconnecting your product.

Introduction

The LaCie 2big Dock delivers everything you expect from LaCie products—high capacity, lightning-fast speeds, and enterprise-class drives. Port by port, slot by slot, the LaCie 2big Dock is a powerful docking station that gives back to you everything that modern laptops took away. The result: a creative space that's entirely streamlined.

This manual provides details on configuring and managing your LaCie 2big Dock Thunderbolt 3. For common questions and answers about your device, please see [Frequently Asked Questions](#).

You can get the latest tips regarding your product and updated technical information at [LaCie customer support](#).

Box content

- LaCie 2big Dock Thunderbolt 3
- External power supply
- Thunderbolt 3 cable (compatible with Thunderbolt 3, USB 3.1 Gen 1, and USB 3.1 Gen 2 ports)
- USB 3.1 (USB-C) to USB 3.0/USB 2.0 adapter cable (compatible with Type A ports)
- Quick Install Guide



Important info: Save your packaging. In the event that the hard drive enclosure should need to be repaired or serviced, it must be returned in its original packaging.

Software

RAID Management

LaCie RAID Manager manages the storage for your LaCie storage device and provides important firmware updates and notifications. Download and install LaCie RAID Manager before connecting the LaCie storage device to your computer. The process automatically installs an important driver that allows LaCie RAID Manager to detect the device and manage RAID arrays. For details and download links, go to www.lacie.com/support/lrm.

Backup

Mac users—Intego Backup Manager Pro is a comprehensive backup solution for macOS, protecting you from data loss by systematically making copies of your documents, applications, and system files. Click [here](#) for

details and download links.

PC users—Genie Backup Manager Pro is the ideal backup solution for small and medium businesses that want to back up and recover their entire system. Click [here](#) for details and download links.

Minimum computer system requirements

The minimum operating system for your computer differs based upon the port you are using. Choose your port and connect your LaCie device to a computer that meets the following minimum system requirements.

Thunderbolt 3

- macOS® 10.12 or later
- Windows 10 or later

USB 3.1

- macOS 10.9 or later
- Windows 8.1 or later

Computer hardware requirements

You can connect your LaCie device to a computer that supports one of the following interfaces:

Thunderbolt 3	Transfer rates can reach up to 40Gb/s
SuperSpeed USB 3.1 Gen 2	Transfer rates can reach up to 10Gb/s
SuperSpeed USB 3.1 Gen 1	Transfer rates can reach up to 5Gb/s
SuperSpeed USB 3.0	Transfer rates can reach up to 5Gb/s
Hi-Speed USB 2.0	Transfer rates can reach up to 480 Mb/s

Minimum free disk space

- 600MB recommended

Features

The LaCie 2big Dock Thunderbolt 3 provides high-end performance with USB-C and dual Thunderbolt 3 connection ports, powerful docking features to quickly access and import files from other devices, and a DisplayPort expansion port for video output.

Connection

- **Dual Thunderbolt 3 connection ports**—Each port provides transfer rates up to 40Gb/s bidirectional and 15W of power to a connected device. You can use the Thunderbolt 3 ports to daisy chain up to five additional LaCie 2big Dock devices or other Thunderbolt 3 storage solutions.
- **USB 3.1 connection port**—Provides universal compatibility with USB-C and USB 3.0 computers and 27W of power to a connected device.

See [Connect your LaCie 2big Dock Thunderbolt 3](#) for details on connecting your device, and [Daisy Chain and Power Delivery](#) for details on daisy chaining multiple storage solutions.

Docking

- **SDXC UHS-II and CompactFlash Revision 6.0 Type I card slots**—Directly ingest files from memory cards. Quickly import photos into Adobe® Lightroom® and Premiere Pro®.
- **USB 3.0 hub**—Delivers 5W of power to connected phones and other devices. Use the hub to transfer files from digital cameras and other drives.

See [Docking Features](#) for details on memory card slots and the USB 3.0 hub.

Expansion

- **DisplayPort 1.2 expansion port**—Connect to high-resolution up to 5K.

See [Expansion Port](#) for details on the DisplayPort 1.2 expansion port.

Thunderbolt 3

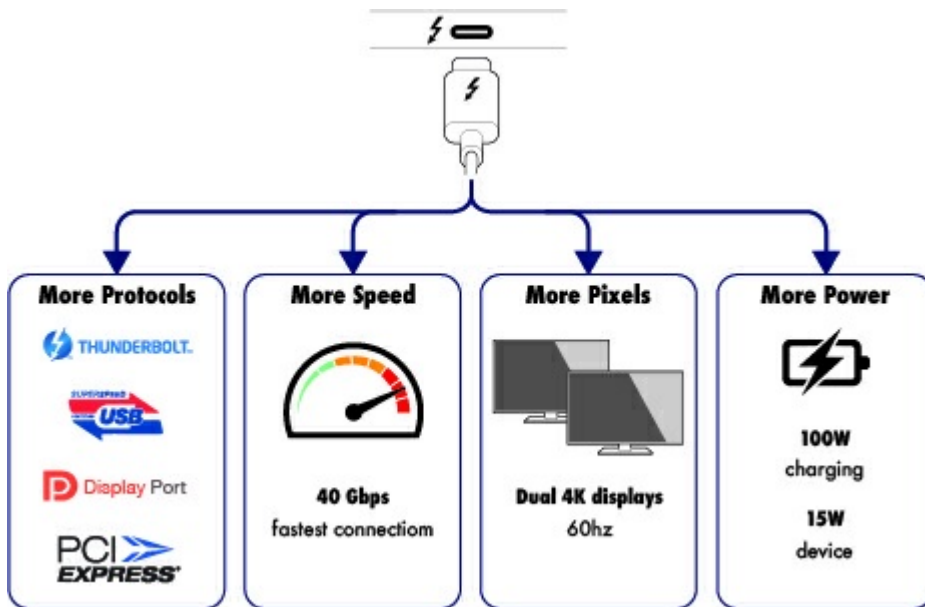

Thunderbolt 3 features and support

Thunderbolt 3 technology provides the fastest data and high-end video transfers over a single, versatile connector. While previous generations of Thunderbolt technology offered impressive transfer rates up to 20Gb/s bidirectional, Thunderbolt 3 doubles the potential up to 40Gb/s bidirectional when connected to other Thunderbolt 3 devices. In addition, Thunderbolt 3 gives priority to the video stream, apportioning the required bandwidth for playback. This is a critical advantage when working with high-end video and 3D graphics.

Thunderbolt 3 uses a USB-C connector specially labeled with a Thunderbolt icon. Since Thunderbolt 3 is protocol agnostic, it supports connections from the following interfaces:

- USB 2.0, USB 3.0 and USB 3.1
- DisplayPort 1.1 and 1.2a
- Thunderbolt 20Gb/s and Thunderbolt 40Gb/s
- Ethernet (with adapter)

Non-Thunderbolt 3 devices that feature USB-C ports can be connected to the Thunderbolt 3 port to terminate a daisy chain.

System Overview

Storage management

LaCie 2big Dock storage is managed by the LaCie RAID Manager software utility. See [Manage RAID](#) for more information.

Specifications

Enclosure dimensions

Side	Dimensions (mm / in)
Width	118 / 4.6
Height	93.3 / 3.7
Length	217 / 8.5

Enclosure weight

Weight (kg / lbs)
2.9 / 6.4

Temperature ranges

Ambient environment	Temperature range
Standard (operating)	+5°C to +40°C
Storage (non-operating)	-20°C to +60°C

Humidity

Environment	Humidity range
Standard (operating)	10% to 60% non-condensing
Storage (non-operating)	5% to 85% non-condensing

Electrical

Power supply: 100-240VAC; 50/60Hz; 60W



Note on the power supply: Use the included power cable with the LaCie 2big Dock Thunderbolt 3.

Views

Front view

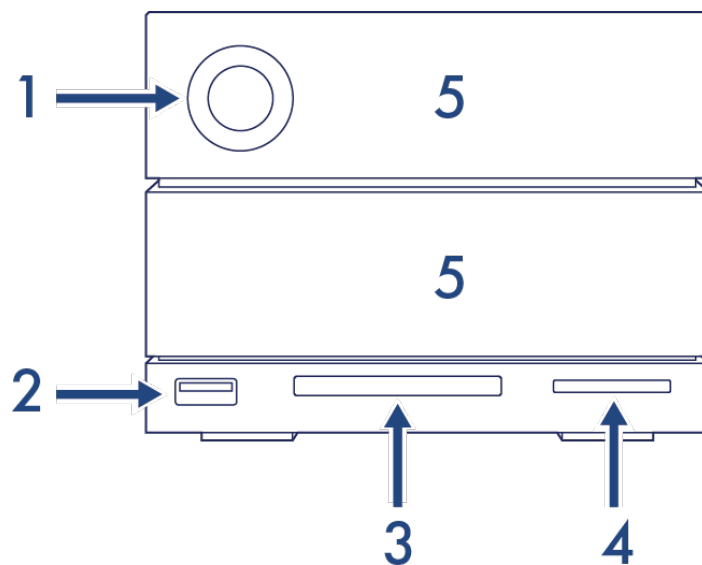

1. **Status LED**—The LED indicates that the device is powered on and provides status signals. See [Operation](#).
2. **USB 3.0 Hub**—Use the hub to charge devices like mobile phones (5W power output). Connect shuttle drives, digital cameras, and other devices to transfer files. See [Docking Features](#).
3. **CompactFlash (CF) Slot**—Use this slot to read CF memory cards. See [Docking Features](#).
4. **Secure Digital (SD) Slot**—Use this slot to read SD memory cards. See [Docking Features](#).
5. **Swappable hard drive trays**—Hard drive trays can be removed to replace failed hard drives. The LaCie 2big Dock hard drives are hot-swappable. See [Hard Drive Maintenance](#).

Rear panel view

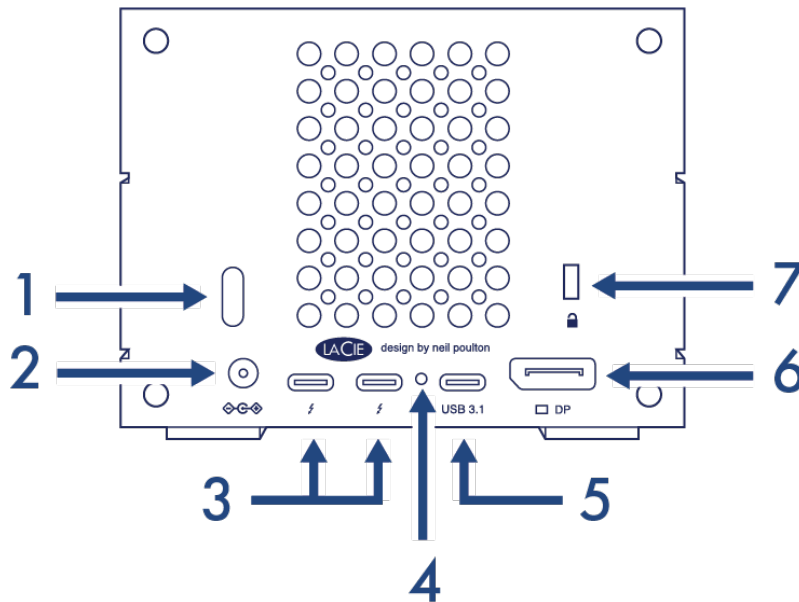

1. **Power button**—Use this button to power the device off and on. The button is also used confirm key actions during RAID configuration. See [Operation](#).
2. **Power input**—Use this port to connect the power cable. Only use the power cable included with your LaCie 2big Dock Thunderbolt 3. Attaching third-party or other LaCie power cables with incorrect voltage can damage the device. See [Operation](#).
3. **Thunderbolt 3 ports**—Use the included Thunderbolt 3 cable to connect to a Thunderbolt 3 port on your computer or other Thunderbolt 3 devices. Since the ports on the LaCie device are not preconfigured with specific roles, you can use either port as the host (connected to a computer) or as part of a daisy chain (connected to other compatible devices). See [Connect your LaCie 2big Dock Thunderbolt 3](#) and [Daisy Chain and Power Delivery](#).

 **Note:** The Thunderbolt 3 and USB 3.1 ports cannot be used at the same time.

4. **Firmware update button**—Updates to the USB firmware are posted on the support page to enhance your product. Only press this button when following instructions to update the USB firmware. Use a thin rigid wire (such as the end of a paperclip) to push the button within the enclosed space.
5. **USB 3.1 port**—Use the included Thunderbolt 3 cable to connect the 2big Dock’s USB 3.1 port to your computer’s USB 3.1 (USB-C) port. Alternatively, you can use the included USB 3.1 to Type A adapter to connect the 2big Dock to your computer’s USB 3.0/USB 2.0 (USB Type A) port. Transfer rates vary by the connection type. See [Connect your LaCie 2big Dock Thunderbolt 3](#).

 **Note:** The Thunderbolt 3 and USB 3.1 ports cannot be used at the same time.

6. **DisplayPort**—Use this port to send the video signal from your computer to a monitor. You can connect a display to the DisplayPort when using the Thunderbolt 3 or USB 3.1 ports. See [Expansion Port](#).
7. **Kensington™ lock port**—Use this port to physically lock the 2big Dock to a desk or rack.

- !** **Important info regarding the ports:** The LaCie 2big Dock can be connected to a computer using one of the Thunderbolt 3 ports or the USB 3.1 port. Connect the device to only one computer using a single cable—do not use the Thunderbolt 3 and USB 3.1 ports at the same time. Do not do any of the following:
- Connect both Thunderbolt 3 ports to a single computer.[?]
 - Connect a Thunderbolt 3 port to one computer and the other Thunderbolt 3 port to another computer.[?]
 - Connect both a Thunderbolt 3 port and the USB 3.1 port to a single computer.[?]
 - Connect a Thunderbolt 3 port to one computer and the USB 3.1 port to another computer or device.

System LEDs

The LaCie 2big Dock Thunderbolt 3 LEDs provide information on the system status.

LED locations

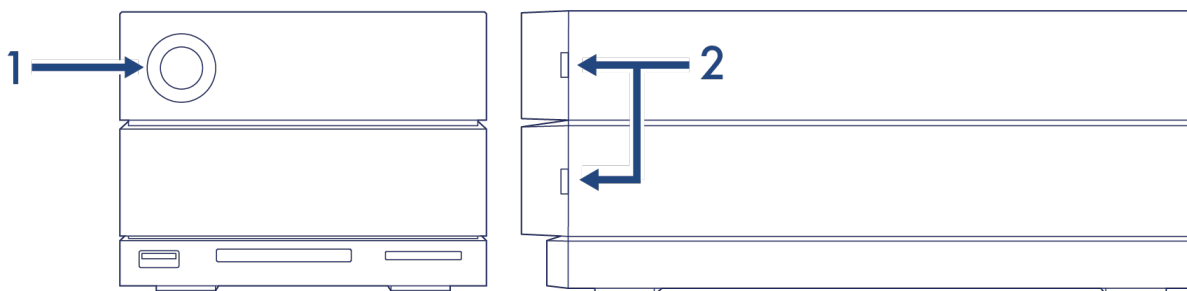

1. **Front**—System status
2. **Side**—Hard drive status

LED behavior

The list of colors below helps you identify the general status of your LaCie 2big Dock.

Color	State
Solid blue	Ready
Blinking blue	Activity
Slow blinking blue (10 second interval)	Power-saving
Fast blinking blue	Startup and shutdown
Blinking red and blue	RAID initialization or synchronization
Blinking red (1 second interval)	Temperature warning or fan failure
Solid red	Temperature critical or fan absent



Technical note regarding power-saving mode and Windows: The device can be placed into power-saving mode on PC's running Windows 8 or higher. However, it is possible that the LED will remain off rather than flash blue every 10 seconds.

Cables

USB-C

USB 2.0 480 Mb/s	USB 3.1 5 Gb/s	USB 3.1 10 Gb/s	DisplayPort Multi-Function 5 or 10 Gb/s	Thunderbolt 3 20 or 40 Gb/s
				

USB-C protocols

USB is a serial input/output technology for connecting peripheral devices to a computer. USB-C is the latest implementation of this standard and it provides convenient connection, higher bandwidth, and all-new power management features. USB-C ports that have the Thunderbolt icon support Thunderbolt 3 devices.

USB-C supports many protocols:

Thunderbolt 3	Transfer rates can reach up to 40Gb/s
SuperSpeed USB 3.1 Gen 2	Transfer rates can reach up to 10Gb/s
SuperSpeed USB 3.1 Gen 1	Transfer rates can reach up to 5Gb/s
SuperSpeed USB 3.0	Transfer rates can reach up to 5Gb/s
Hi-Speed USB 2.0	Transfer rates can reach up to 480 Mb/s
DisplayPort	Up to 8K with compatible devices and backwards compatible to VGA and DVI

The USB-C ports on LaCie 2big Dock are:

- Thunderbolt 3 (2 ports)
- USB 3.1 Gen 2 (1 port)

Thunderbolt 3 includes support for DisplayPort up to 5K. You can connect LaCie 2big Dock to any USB-C or USB Type A port but transfer rates vary. See below for more details.

Easy to connect

Connecting your product is easy since the USB-C cable is identical on both ends. In addition, the USB-C ports on your LaCie hard drive enclosure and computer are conveniently rounded to accept the cable end in any orientation.

Thunderbolt 3 (USB-C) cable

Thunderbolt 3 can attain up to 40Gb/s as opposed to Thunderbolt 2's 20Gb/s.

Use the included Thunderbolt 3 (USB-C) cable to ensure maximum data transfer performance when used with compatible Thunderbolt 3 ports.



Connector face (Thunderbolt 3)	Cable end (Thunderbolt 3)
	

The Thunderbolt 3 cable can also be used to connect the USB 3.1 (USB-C Gen 2) port on the LaCie 2big Dock to a USB 3.1 (USB-C Gen 2) port on your computer. USB 3.1 Gen 2 can attain up to 10Gb/s as opposed to USB 3.0 at 5Gb/s and USB 2.0 at 480Mb/s.

USB 3.1 (USB-C)-to-USB Type A cable

Use the USB 3.1 (USB-C)-to-USB Type A cable for compatibility with computers that do not have a USB-C port. The USB-C end is connected to the LaCie device and the Type A end is connected to the computer's USB 3.0 or USB 2.0 Type A port.

Hard drive performance is limited to USB 3.0 transfer rates when connected to a USB 3.0 port and USB 2.0 transfer rates when connected to a USB 2.0 port.

Connector face (USB-C to 2big Dock)	Cable end (USB-C to 2big Dock)
 USB 3.1	

Connector face (USB-C to computer)	Cable end (USB-C to computer)
------------------------------------	-------------------------------

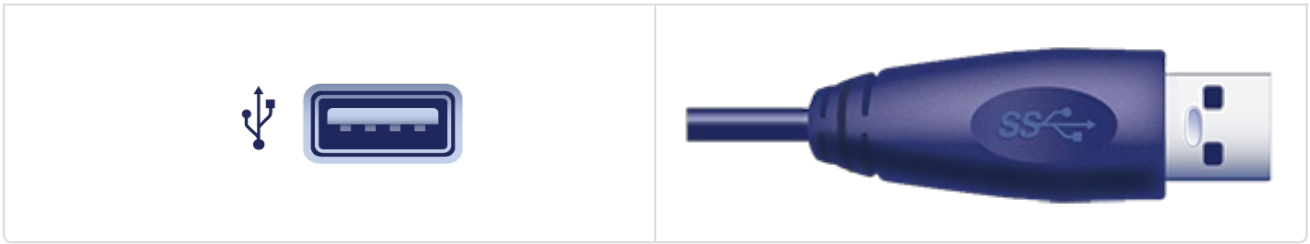

! **Caution:** Due to poor construction, many third-party USB-C cables can cause irreparable harm to devices such as your computer and LaCie device. LaCie is not responsible for damage to your LaCie 2big Dock Thunderbolt 3 caused by third-party cables.

Connect your LaCie 2big Dock Thunderbolt 3

Windows and Thunderbolt 3

Your LaCie Thunderbolt 3 storage device is certified for use with Windows PCs that have a Thunderbolt 3 port. However, you may experience connectivity issues between the storage device and the Thunderbolt 3 port on a Windows PC. Therefore, before setting up your LaCie Thunderbolt 3 storage device, please visit your PC manufacturer's website to update your Windows PC to the latest versions of:

- BIOS
- Thunderbolt 3 firmware
- Thunderbolt 3 driver

Also, make certain that your PC has the most recent version of Windows 10.

For questions regarding your PC, please contact the PC manufacturer. You can also review the following website for additional information: <https://thunderbolttechnology.net/updates>. This issue pertains to the Thunderbolt 3 port and does not affect USB ports.

Step 1 - Download and install LaCie RAID Manager

LaCie RAID Manager manages the storage for your LaCie storage device and provides important firmware updates and notifications. Download and install LaCie RAID Manager before connecting the LaCie storage device to your computer. The process automatically installs a driver that allows LaCie RAID Manager to detect the device and manage RAID arrays.

1. On the computer that will connect to the LaCie storage device, go to www.lacie.com/support/lrm.
2. Download LaCie RAID Manager for Mac or Windows.
3. Launch the Installer.
4. Follow the on-screen instructions to complete the installation.

Step 2 - Connect LaCie 2big Dock to your computer

Connect your device to your computer using Thunderbolt 3 or USB.



Important info regarding the ports: The LaCie 2big Dock can be connected to a computer using the USB 3.1 port or the Thunderbolt 3 port. However, do not connect both ports to a single computer at the same time, or connect each port to separate computers.

Thunderbolt 3 connection

Connect the included Thunderbolt 3 cable to:

1. 2big Dock
2. PC or Mac

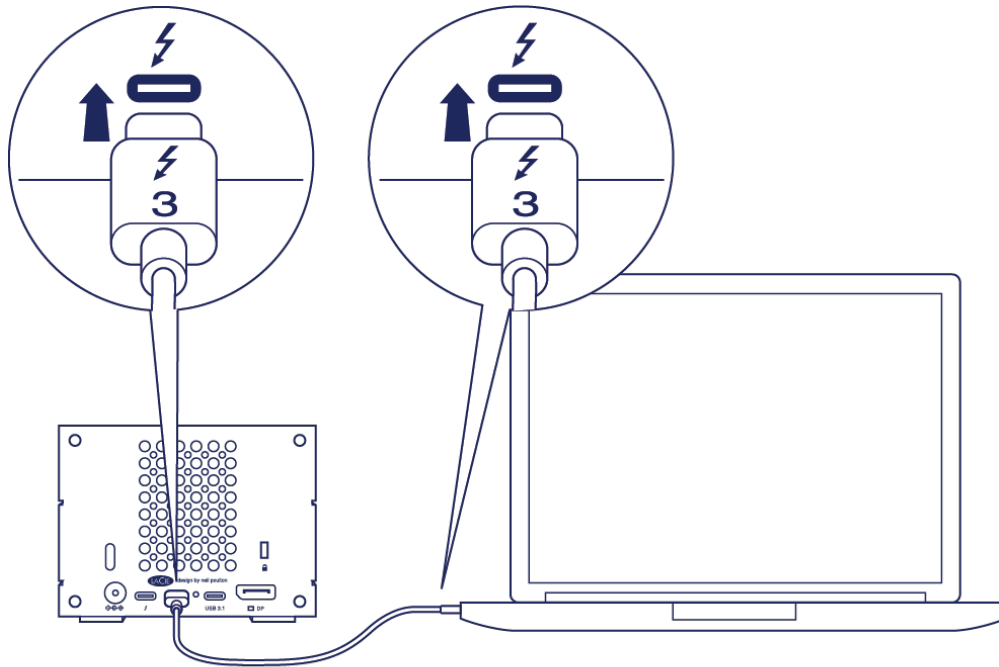

USB 3.1 Gen 1 or 2 connection

PC or Mac with a USB-C port

The Thunderbolt 3 cable can be used to connect the USB 3.1 (USB-C) port on the LaCie 2big Dock to a USB 3.1 (USB-C) port on your computer.

Connect the included Thunderbolt 3 cable to:

1. 2big Dock. Make certain to use the correct port with the text .
2. PC or Mac. Connect to a USB-C port with the USB 3.1 Gen 1 or USB 3.1 Gen 2 icon.

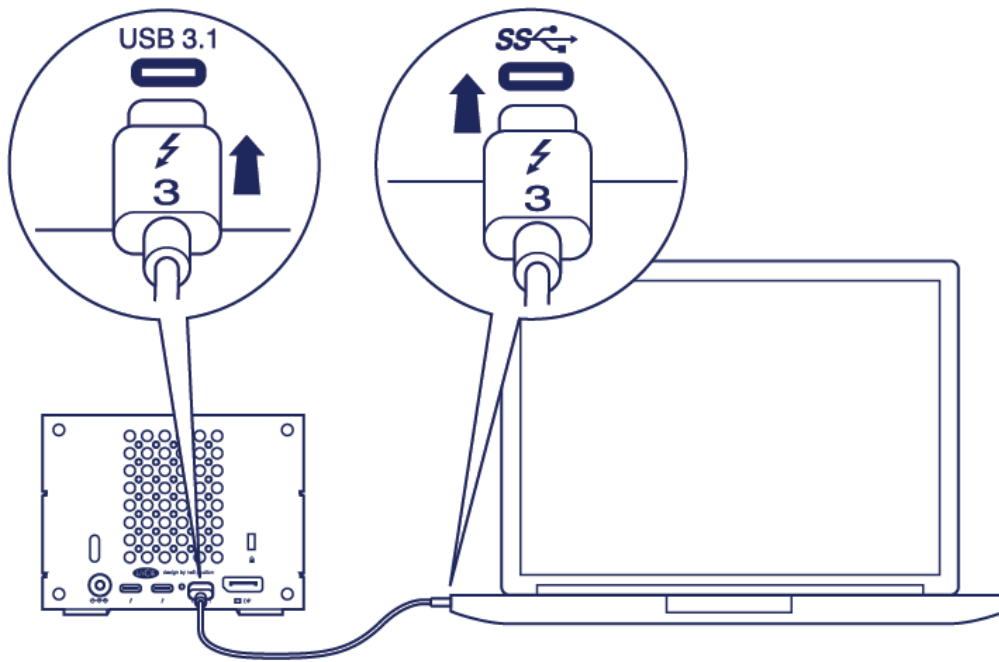

PC or Mac with a USB 3.0 or USB 2.0 port (Type A)

Connect the included USB 3.1 (USB-C) to USB 3.0/USB 2.0 adapter cable (compatible with Type-A ports) to:

1. 2big Dock (USB-C end)
2. PC or Mac (USB Type-A end)

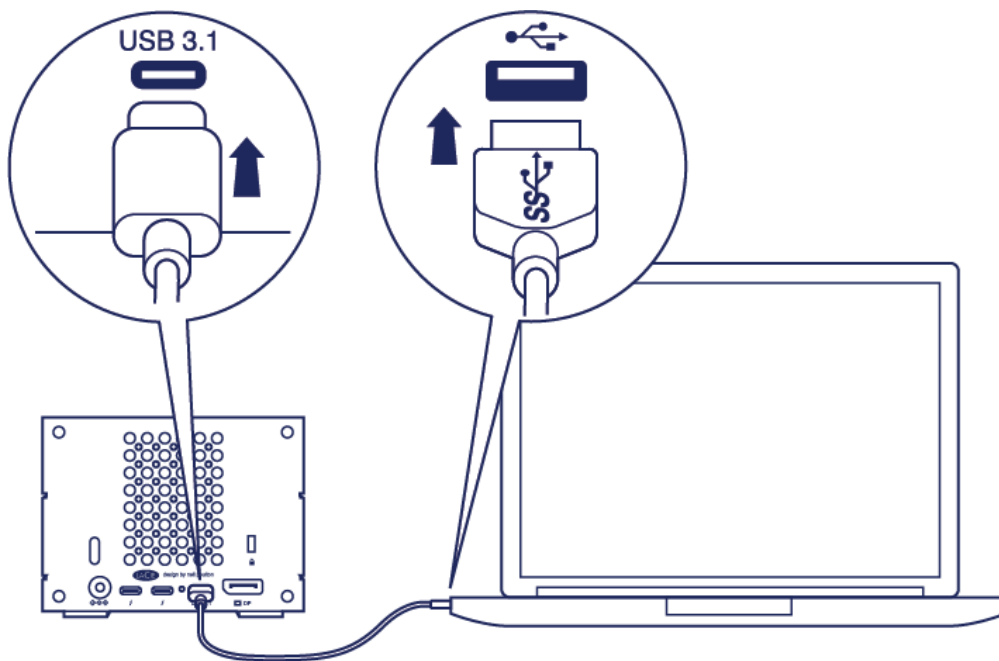

Step 3 - Power connection

Only use the power cable provided with your device. Attaching third-party or other LaCie power cables can damage your device.

Connect the included power cable in the order listed below.

1. 2big Dock power input.
2. A live power outlet.

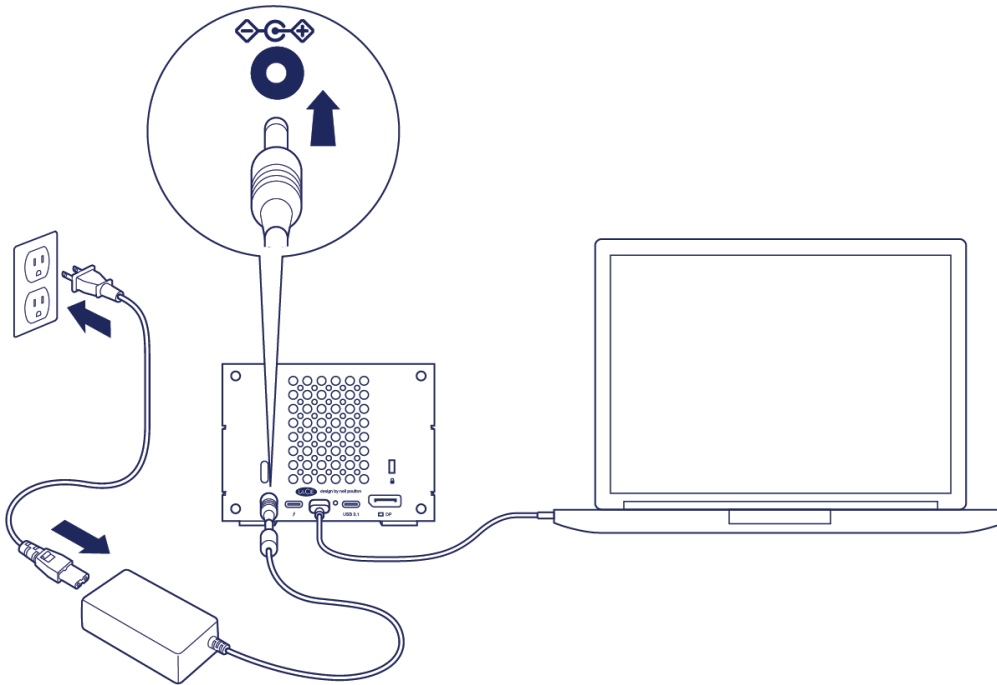

Storage format

Your LaCie device is formatted as HFS+ for Mac. Also, the dual disks are configured for optimal performance using RAID 0. You can change the configuration to RAID 1, which protects data in case one disk fails. Use LaCie RAID Manager to make changes to the RAID.

To learn more about RAID levels and how to use LaCie RAID Manager, see [Manage RAID](#).

Windows

When first connecting the device, the disks must be configured and formatted since Windows does not support HFS+. You must use LaCie RAID Manager to delete the current RAID array and create a new one. Once you've created the new array, you will need to partition and format it. See [Formatting and Partitioning](#) for details.

Operation

LaCie 2big Dock is ready to be powered on when:

- It is connected to a computer that supports Thunderbolt 3 or USB.
- It is plugged into a live power outlet.

The LEDs blink blue while the disks spin up.

! **Caution:** Do not operate LaCie 2big Dock Thunderbolt 3 until the ambient temperature is within the specified temperature range (see [System Overview](#)). If the hard drives have been recently installed, make sure they have time to acclimatize to the ambient temperature before operating them.

Power on

In most instances, the LaCie 2big Dock powers on automatically when connected to a computer and an active power source. However, the power button can be used to power on the device if the following two conditions are met:

- The device was powered off using a long press^[?].
- The device remains connected to the computer's USB port and an active power source.

To power on the LaCie 2big Dock, push the power button for one second.

Power off

Follow the steps below to turn the device off:

1. Make certain that the device's volumes are not being accessed.^[?]
2. Eject the device's volumes from your computer's operating system. Once the volumes have been properly ejected, the device enters power-saving mode.^[?]
3. Disconnect the device from your computer.

Power-saving mode

Your LaCie 2big Dock can conserve energy by entering power-saving mode. The hard drives within the enclosure spin down to reduce power consumption when the 2big Dock is in power-saving mode. Power-saving mode can extend the life of the hard drives by sparing them from working during extended periods of inactivity. The device can be put into power-saving mode using the power button:

1. Make certain that the device's volumes are not being accessed.

2. Eject the volumes from your computer's operating system.
3. Apply a short press to the power button. A short press lasts no longer than 1 second.

To wake up the device, apply another short press.

Power-saving mode: daisy chain

You can daisy chain Thunderbolt 3 technology devices when the LaCie 2big Dock is in power-saving mode. Though the hard drive spins down when the device enters power-saving mode, the Thunderbolt signal remains constant—daisy-chained devices continue data operations without interruption. See [Daisy Chain and Power Delivery](#) for details.

Power-saving mode: USB 3.0 hub

When the LaCie 2big Dock is in power-saving mode, you can continue to browse and manage devices connected to the USB 3.0 hub. The connected devices continue to receive power from the 2big Dock.

Power-saving mode: managed by the PC/Mac

You can initiate power-saving mode on your computer by performing one of the following:

- Place the host computer into sleep mode.
- Mac: Go to **System Preferences > Energy Saver** to enable sleep mode for hard drives.
- Windows: Go to **Control Panel > Hardware > Power Options > Choose a power plan > Change advanced power settings**. Click on **Hard disk** and **Turn off the hard disk after**. Choose the time to spin down USB hard drives.

To exit power-saving mode:

Entering power-saving mode	Exiting power-saving mode
The host computer placed the product into power-saving mode due to inactivity.	Access the device's volume on the host computer. For example, copy files to its volume.
The computer is in sleep mode.	Wake up the computer.



Note on ejecting the volume and power-saving mode: The device enters power-saving mode when its volumes are ejected. To access the device's volumes, unplug the cable from the back of the device and reconnect it.

Receiving power

The LaCie 2big Dock powers on automatically when it is:

- Connected directly to a computer via the Thunderbolt 3 or USB-C port. The computer must be powered

on.

- Connected to a live power source via the included power supply.



Important info regarding the ports: The LaCie 2big Dock can be connected to a computer using the USB 3.1 port or the Thunderbolt 3 port. However, do not connect both ports to a single computer at the same time, or connect each port to separate computers.

Short push



Important info: Always eject the LaCie 2big Dock volumes from your computer before applying a short push.

A short push is a manual depression on the power button that lasts no longer than one second. When the product is operating, a short push spins down the hard drives within the enclosure and initiates power-saving mode. The Thunderbolt 3 ports remain active and are available for daisy chaining. For example, a display that is daisy chained with the device is still available to the computer following a short push.

Short push and RAID synchronization/initialization

Applying a short push during RAID synchronization or initialization spins down the hard drives. The RAID synchronization/initialization continues the next time you spin the hard drives up via a short push.

Long push

A long push is a manual depression on the button that lasts more than four seconds. When the product is operating, a long push will cut the power to the LaCie 2big Dock, forcing it to shut down immediately. A long push is not recommended for general use as it may result in data loss.

Removing the Thunderbolt cable during operation

Removing the cable during operation can result in lost data. If the cable is removed while the system is synchronizing or initializing the RAID, the synchronization/initialization continues but connection to the computer and your data is lost.

Quiet operation and heat management

To reduce noise during operation, the LaCie 2big Dock uses a Noctua® cooling fan to pull heat away from the internal components. In addition to being exceptionally quiet, the Noctua cooling fan is temperature controlled, which guarantees optimal heat management by adjusting the rotational speed for the

environment. Additionally, the enclosure's metal casing dissipates heat from the hard drives, keeping them safe and prolonging their life. Since LaCie's unique design draws heat away from the internal hard drives, the external casing may be warm to the touch after extended use.

i **Important info:** The wide exhaust chamber on the rear of LaCie 2big Dock allows for enhanced airflow. Make sure that it is not obstructed and that there is a natural airflow across the casing.

Position and stacking

Always make certain to place LaCie 2big Dock on a flat, even surface designed to support the heat output and airflow of a professional hard disk enclosure. For proper heat dissipation, LaCie 2big Dock is designed to stand on its rubber feet, situated on the bottom of the enclosure. **DO NOT** place the enclosure on its side when it is powered on.

DO NOT stack multiple enclosures on top of each other. Stacking two or more enclosures poses a severe risk that the devices will fall. Also, **DO NOT** stack other hard drives, enclosures or equipment on top of the device.

The warranty for your device is voided if you:

- Stack device enclosures.
- Stack other hard drives, enclosures or equipment on top of the device.

Docking Features

The LaCie 2big Dock provides you with convenient means of managing your creative digital content. Insert SD and CompactFlash cards to transfer files for safe storage. Connect smartphones, cameras, and other devices to the USB 3.0 hub to access content.

USH-II Secure Digital Extended Capacity (SDXC) Memory Card Reader

Reading an SD memory card

1. Hold your SD, SDHC, or SDXC memory card upright with the label on top (pins on bottom).
2. Insert the card into the SD slot on the front of the device as far as it will go (you may hear an audible 'click'), and then release. The card is now locked in the slot.
3. Open a Finder or Explorer window to browse and manage the contents of the SD card.

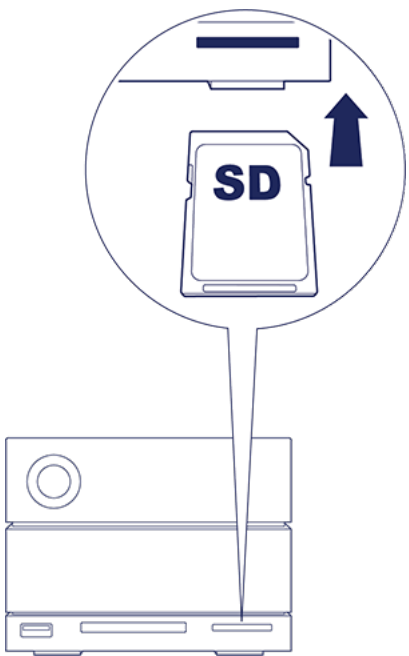

Removing an SD memory card

1. Make sure that the SD memory card is not being accessed.
2. Using a Finder or Explorer window, eject the SD card volume.
3. Push the card into the SD slot on the front of the device as far as it will go (you may hear an audible 'click'), and then release. The card is ejected.
4. Remove the card from the slot.

CompactFlash (CF) Revision 6.0 Type I (UDMA 7) Memory Card Reader

Reading a CF memory card

1. Hold your CompactFlash memory card upright with the label on top.
2. Insert the card into the CF slot on the front of the device and gently push it in until it's seated in the slot.
3. Open a Finder or Explorer window to browse and manage the contents of the CF card.

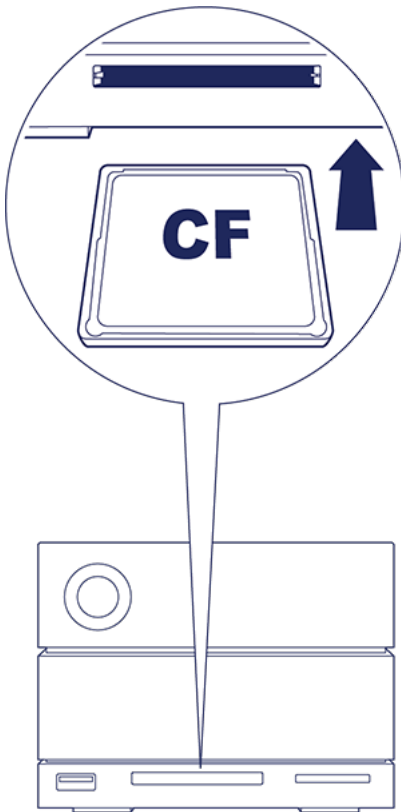

Removing a CF memory card

1. Make sure that the CF memory card is not being accessed.
2. Using a Finder or Explorer window, eject the CF card volume.
3. Remove the card from the slot.

USB 3.0 Hub

The USB 3.0 hub delivers 5W of power to connected phones and other devices. Use the hub to transfer files from digital cameras and other drives.

Connecting a device to the USB 3.0 hub

1. Hold the USB 3.0 end of the cable upright.
2. Insert the cable end into the USB 3.0 port on the front of the device.
3. Open a Finder or Explorer window to browse and manage the contents of the device.

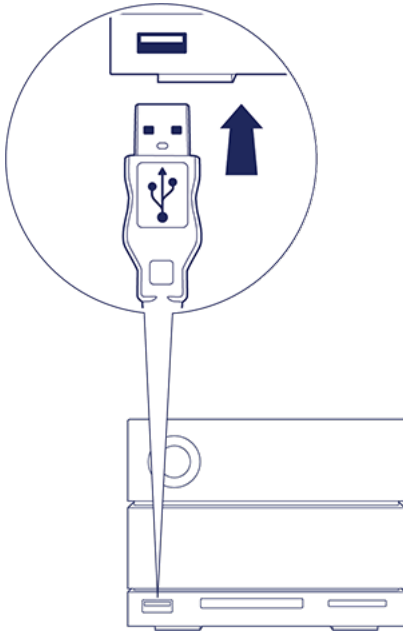

Disconnecting a device from the USB 3.0 hub

1. Make sure that the device is not being accessed.
2. Using a Finder or Explorer window, eject the device volume.
3. Remove the USB 3.0 end of the cable from the port.

Expansion Port

DisplayPort 1.2

DisplayPort is a digital display interface used to connect a video source to a display device (for example, a computer monitor) as well as other forms of digital data. DisplayPort is backwards compatible with VGA, DVI and HDMI audio/video interfaces through the use of an adapter (not included).

The 2big Dock passes the signal through the Thunderbolt 3 or USB 3.1 connection to the DisplayPort 1.2 expansion port.



Note on DisplayPort 1.2 and HDMI adapters: The DisplayPort 1.2 on your LaCie 2big Dock does not support DP++ to HDMI adapters. If you do not have a DP 1.2 to HDMI adapter but still want to connect to an HDMI display, it's recommended that you daisy chain your LaCie 2big Dock to the display using a USB-C to HDMI adapter (not included). This configuration is only possible if the LaCie 2big Dock is connected to your computer via a Thunderbolt cable.

Connecting the DisplayPort

1. Insert the DP 1.2 end of the cable or adapter into the port on the back of the LaCie 2big Dock until it clicks into place. The cable/adapter is now locked into the DP 1.2 port.

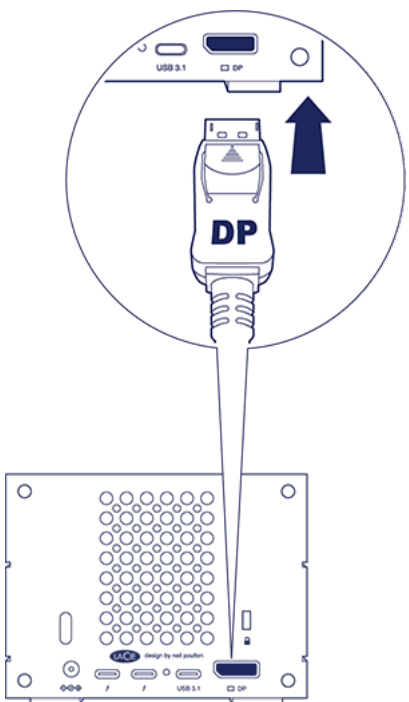

2. Connect the VGA, DVI or HDMI adapter to your configured audio/video display.

Disconnecting the DisplayPort

1. Grasp the DP 1.2 end of the cable or adapter that's connected to your LaCie 2big Dock.
2. Hold down the release tab with your thumb, and then pull back to remove the cable from the port.

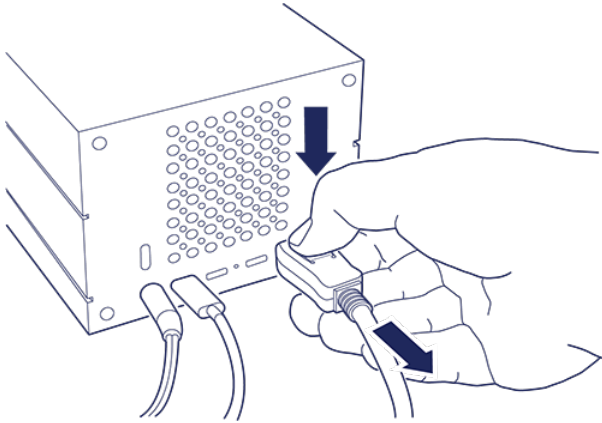

Daisy Chain and Power Delivery

Use the two Thunderbolt 3 ports on the LaCie 2big Dock for:

- Direct connection to a computer that is compatible with Thunderbolt 3 technology.
- Daisy chaining with devices and displays that are compatible with Thunderbolt 3 technology.

Daisy chain Thunderbolt 3 devices

Thunderbolt 3 is an update of Thunderbolt 2 technology. While Thunderbolt 2 technology continues to provide impressive transfer rates up to 20Gb/s bi-directional, Thunderbolt 3 offers improved performance with a potential transfer rate of up to 40Gb/s bidirectional. Thunderbolt 3 technology also gives you greater flexibility when using video and data, assigning greater throughput to the stream that carries the heavier load. You must have a computer that supports Thunderbolt 3 to take advantage of the updates in performance and the intelligent sharing of bandwidth.

Similar to Thunderbolt 2 technology, a single Thunderbolt 3 daisy chain can have up to seven devices, including the computer. For example, you can daisy chain five LaCie 2big Dock enclosures on the same line with a display.

How to daisy chain

Connect the cable to one of the interface ports on the back of LaCie 2big Dock and to your computer. The additional port on your device can be used to daisy chain compatible Thunderbolt 3 peripherals, such as hard drives and monitors. If you have another Thunderbolt 3 storage device, make certain to connect it to the daisy chain before adding compatible displays or USB 3.1 (USB-C) devices. See below for an example of the order of devices in a Thunderbolt 3 daisy chain.

1. Computer with a Thunderbolt 3 port
2. LaCie 2big Dock Thunderbolt 3 (Thunderbolt 3 ports)
3. LaCie d2 Thunderbolt 3 (Thunderbolt 3 ports)
4. LaCie Bolt 3 (Thunderbolt 3 ports)
5. LaCie Porsche Desktop (USB 3.1 (USB-C) port)

USB 3.1 (USB-C) devices can terminate a Thunderbolt 3 daisy chain and should always be the last device. It must be connected to the secondary Thunderbolt 3 port on the preceding device. (The USB 3.1 device will not be recognized if connected to the preceding device's USB-C port.)



Note on the USB 3.1 (USB-C) port: USB 3.1 does not support daisy chaining devices. Therefore, a USB 3.1 (USB-C) port on your computer cannot be used to daisy chain devices.

i **Important cable info:** When connecting your enclosure to a computer or compatible devices, use cables specifically constructed to support Thunderbolt 3.

i **Important info:** To reach Thunderbolt 3 transfer rates up to 40Gb/s bidirectional, LaCie 2big Dock Thunderbolt 3 must be connected to a computer that supports Thunderbolt 3 technology.

Daisy chain: power-saving mode

You can daisy chain Thunderbolt 3 devices even when the LaCie 2big Dock hard drives are spun down. Power-saving mode is initiated by applying a short push on the power button (see [Operation](#)). The status LED blinks slowly, indicating that the device is in power-saving mode.

Power delivery

You can connect compatible devices that support charging via USB-C to the Thunderbolt 3 ports or the USB 3.1 port. A Thunderbolt 3 port on LaCie 2big Dock outputs up to 15W of power, while the USB 3.1 port provides up to 27W of power. The LaCie 2big Dock must receive power via its power cable in order to deliver power to compatible devices.

i **Note:** The power delivered may not be sufficient to charge a laptop.

i **Important info:** LaCie is not responsible for devices that experience harm, damage, or malfunction when connected to LaCie 2big Dock.

Manage RAID

Your LaCie 2big Dock can be configured as RAID 0 or RAID 1. Each RAID level has its own advantages:

RAID level	Capacity	Protection	Speed	Factory default
RAID 0	100%	None	Excellent	Yes
RAID 1	50%	Excellent	Good	No

RAID 0—Data is not duplicated on both hard drives in RAID 0. This results in faster transfers and more storage, since the full capacity of both drives can be used to store unique data. However, RAID 0 lacks a very important feature: data protection. If a hard drive fails, all data in the array is lost.

RAID 1—RAID 1 provides greater safety since data is duplicated on each disk in the array. If a single disk fails, the data remains available on the other disk. However, this comes at a cost—since the same data is written to each drive, copying data takes longer and overall storage capacity is reduced by 50%. RAID 1 is a good choice when safety is more important than speed or disk space.

Sign in to LaCie RAID Manager

Administrator users

Users with administrator privileges for the computer can launch LaCie RAID Manager without signing into the application.

Standard users

A standard (unprivileged) user launching LaCie RAID Manager is prompted to sign in with administrator credentials. An administrator should launch the application to prepare the device for a standard user.

LaCie RAID Manager Navigation

LaCie RAID Manager's intuitive interface helps you manage your device's storage.

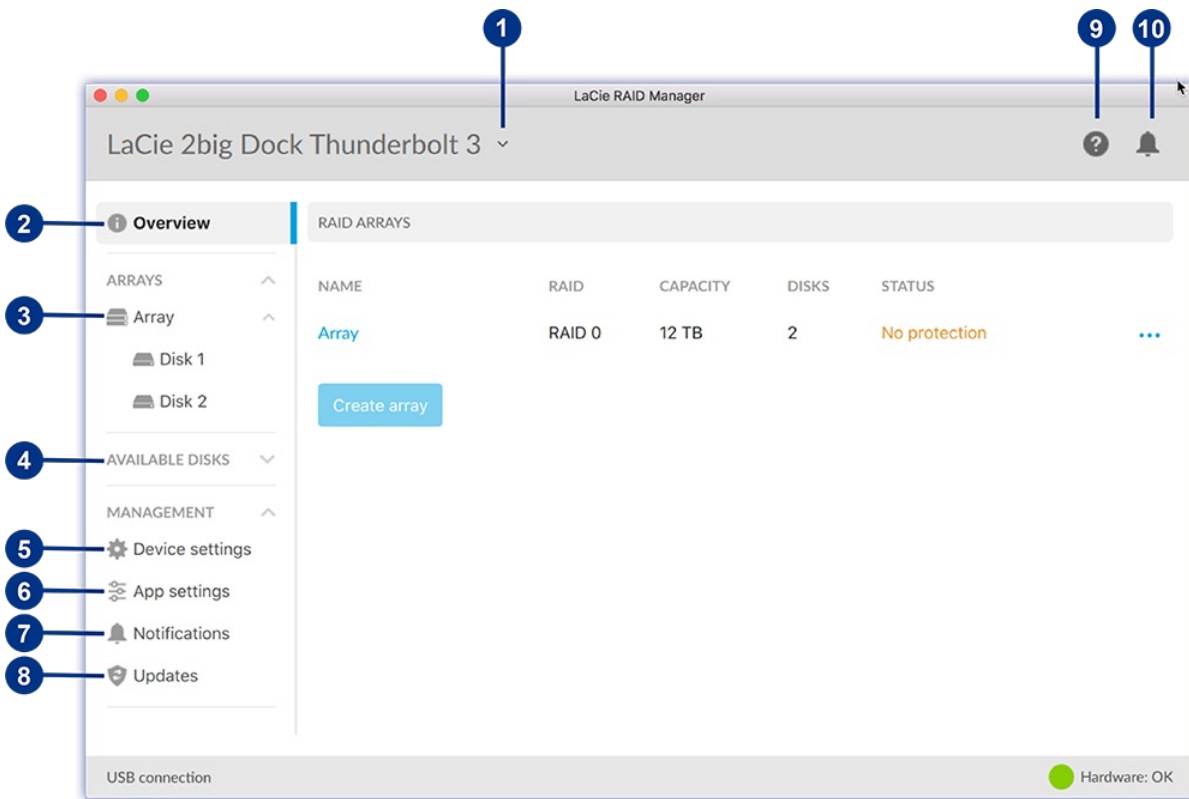

- 1 **Device** - Select a connected device.
- 2 **Overview** - Create or delete an array, and view information on your current RAID configuration.
- 3 **Array** - View and manage your array and disks.
- 4 **Available Disks** - When no array is currently configured, the LaCie 2big Dock's disks are listed here as available for RAID configuration.
- 5 **Device settings** - Register your device and change device settings.
- 6 **App settings** - Change LaCie RAID Manager app settings.
- 7 **Notifications** - View device events, download the event log, and set up email alerts.
- 8 **Updates** - Check for updates to LaCie RAID Manager and your device firmware (internet connection required).
- 9 **Info** - Go to the LaCie RAID Manager support page (internet connection required).
- 10 **Recent notifications** - View a list of recent device operations and events.

Device

If your computer is connected to multiple compatible devices, click the arrow and select the device you want to manage.

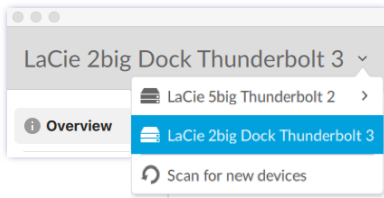

Scan for new devices

Allow LaCie RAID Manager to scan for new devices connected to your computer.

Overview

When a compatible device with an array is connected to your computer, the Overview screen provides a summary of information about your RAID array.

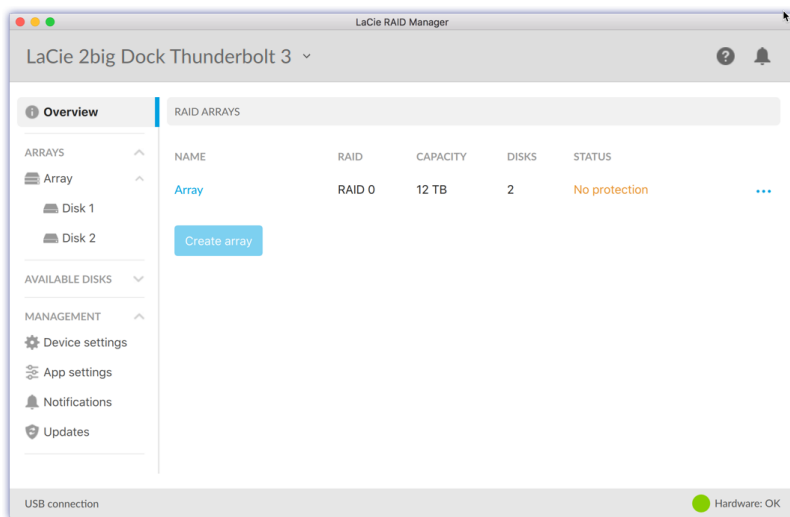

View array details

Double click on a listed array to view and manage the array.



Delete an array

To delete an array:

1. Click on the More icon and select **Delete** to delete the array and all of its data.

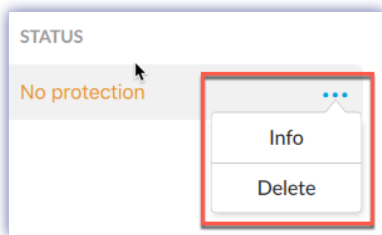

Warning: The data cannot be recovered from the LaCie storage device once the array has been deleted.

2. At the prompt, confirm that you want to delete the array by pushing the power button on the back of the device.

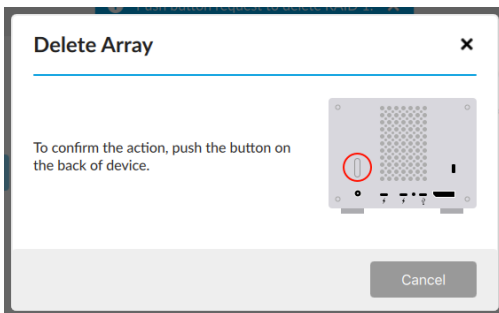

Note: The deletion process may take up to several minutes to complete. Do not disconnect or power off the device while LaCie RAID Manager deletes the array. The **Create array** button on the Overview screen will not be enabled until the deletion process is complete.

Create an array

If a compatible device with no array is detected, you're prompted to create an array.

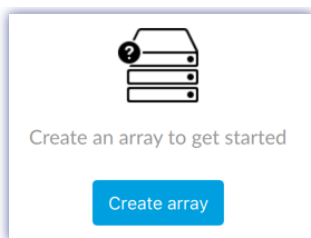

To create an array:

1. Click **Create array**.
2. Choose the RAID level you want to create and click **Next**.

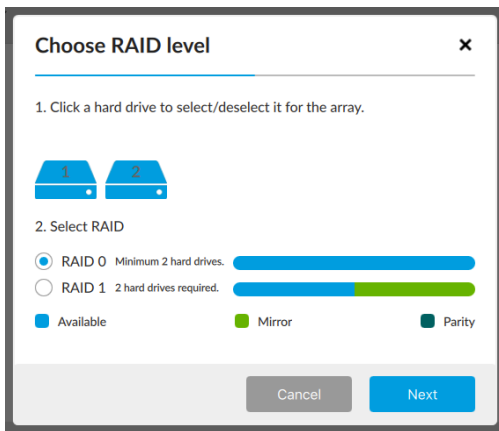

3. Review the summary and click **Finish**.
4. Confirm that you want to create the array by pushing the power button on the back of the device.

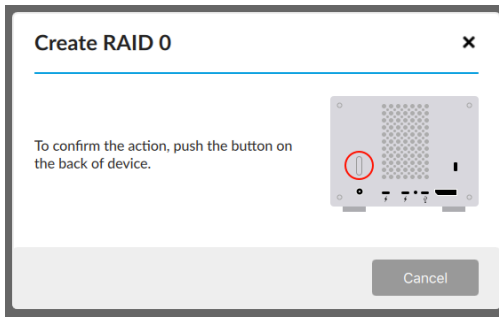

After creating an array, your operating system prompts you to initialize and format it. Follow the instructions to format the array and use it with your computer. For more information about hard drive formats, see [Formatting and Partitioning](#).

Rescan for devices

If no compatible device is detected, the Overview screen prompts you to connect a LaCie storage device.

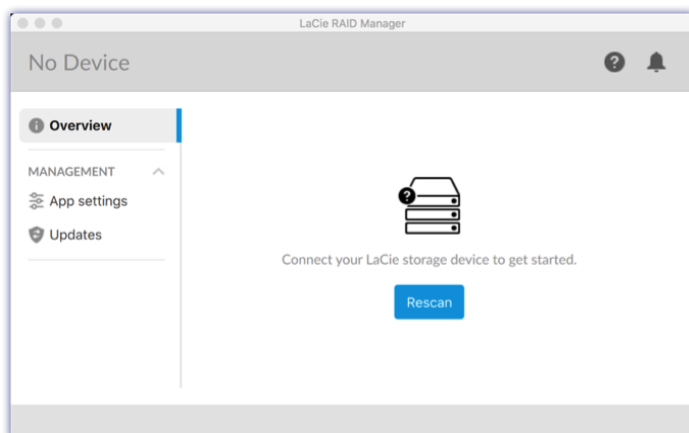

1. Make sure your device is connected to your computer and to a power source.
2. Verify that the device is not in power-saving mode (the LED light should be solid blue).
3. Click **Rescan**.

Array

Click on the Array icon to view information and options related to the array.

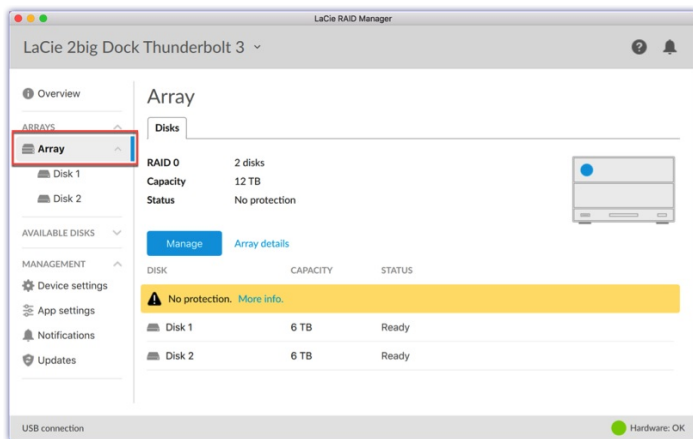

View array details

Click **Array details** to view information on your current array.

Manage array

Click **Manage** to see available management actions:



Delete array

You can initiate the array deletion process from this menu. See [Delete an array](#) above for a description of the process.

View disk details

Click on a Disk icon to view disk details.

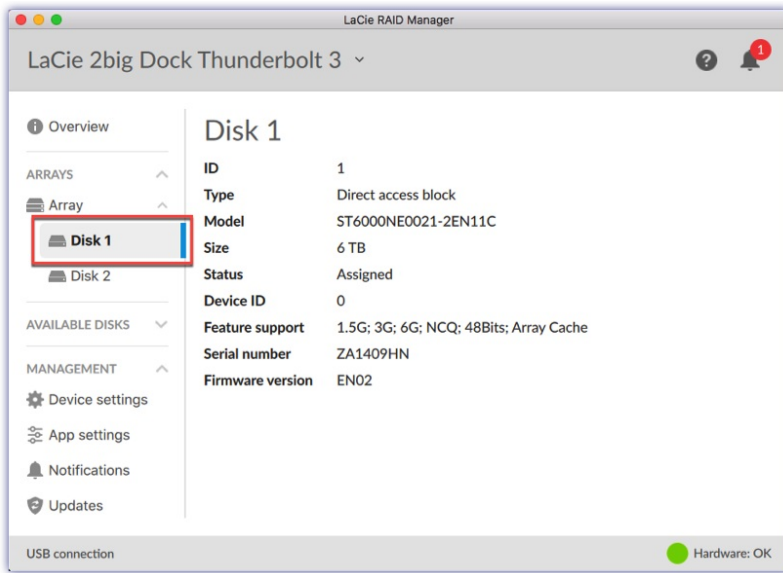

Device settings

Click **Device settings** to change settings for your LaCie 2big Dock.

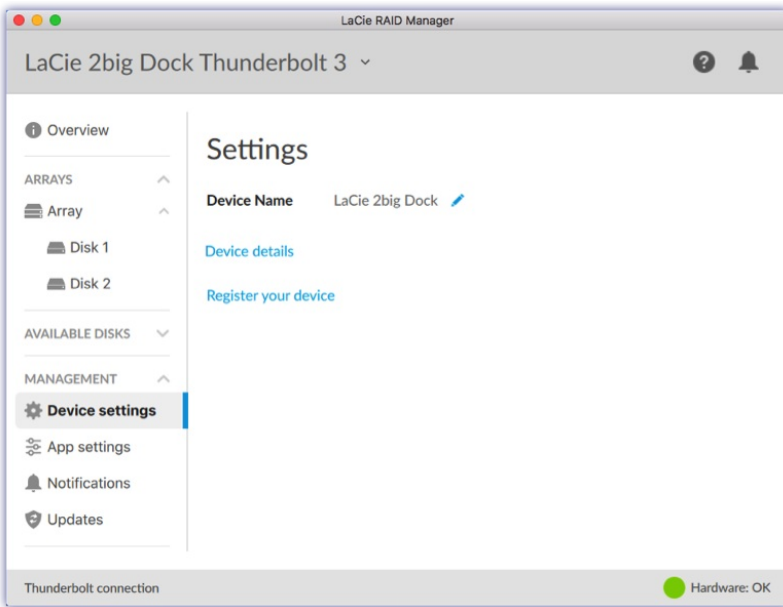

Change device name

To change the name of your device:

1. Click on the Edit icon to change the name of the device.

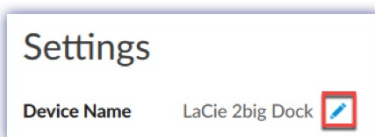

2. Enter a new name in the edit field (up to 19 characters in length).
3. Press **Enter**.

Register your device

Click **Register your device** to go to the LaCie Product Registration page. Internet connection required.

View device details

Click **Device details** to see information related to your hardware.

App settings

Click **App settings** to change LaCie RAID Manager settings.

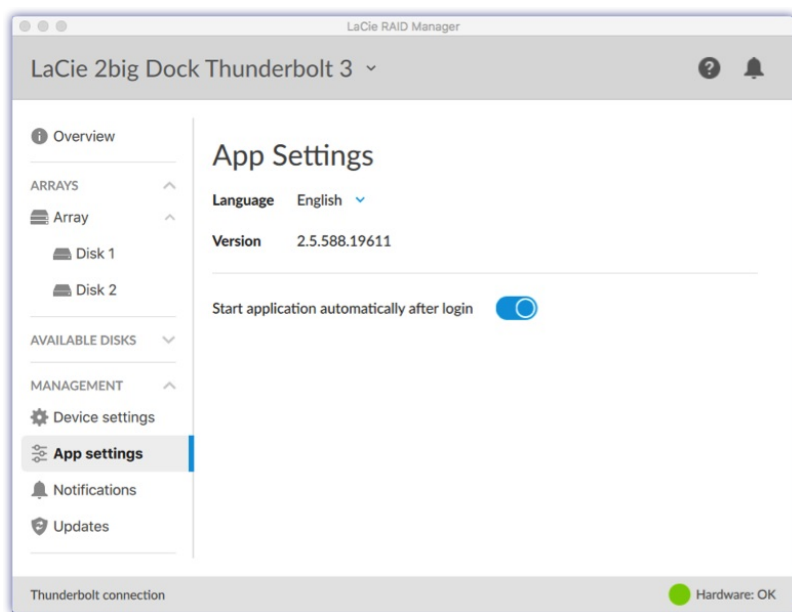

Change language settings

Click on the arrow to select a different language for LaCie RAID Manager.

Change autostart setting

When enabled (default setting), LaCie RAID Manager starts automatically after you sign in to your computer. Click the toggle to change the autostart setting.

Notifications

Click **Notifications** to view device events, download the event log, and set up email alerts.

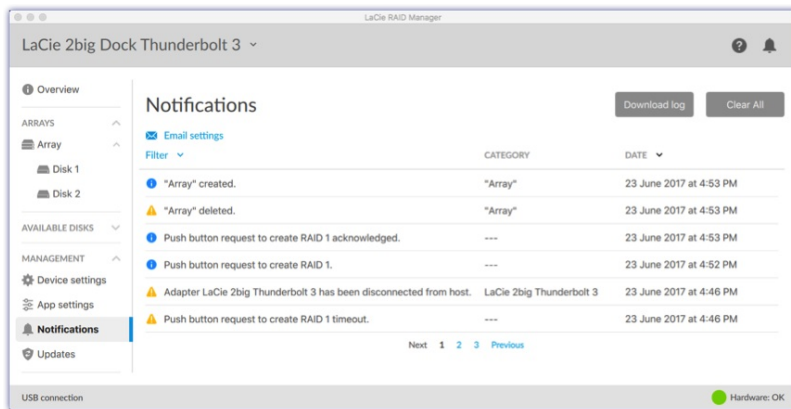

Download log

Click **Download log** to save a .log file to your computer containing a list of events related to your device.

Clear notification entries

Click **Clear All** to clear the list of notifications.

Email settings

LaCie RAID Manager can send you email updates on the health and status of your device. Make certain that your computer has internet access and that LaCie RAID Manager remains open in order to send the email notifications.

1. Click **Email settings**.
2. Enter your email address.
3. Select the types of content you want notifications for.
4. Click **Save**.

Custom server

By default, emails are sent from LaCie's server. However, you can configure email notifications to be routed through a custom server.

1. Click **Email settings**.
2. Click the arrow next to Email server and choose **Custom**.

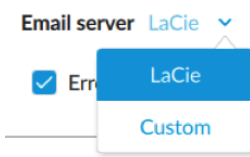

3. Complete all fields.

Email Settings ✕

Notifications Email server **Custom** ▾

Content: Informational Warning Error

Email

SMTP server Port: SSL

Username

Password

4. Click **Save**.

Updates

Click **Updates** to view your current version of firmware and LaCie RAID Manager.

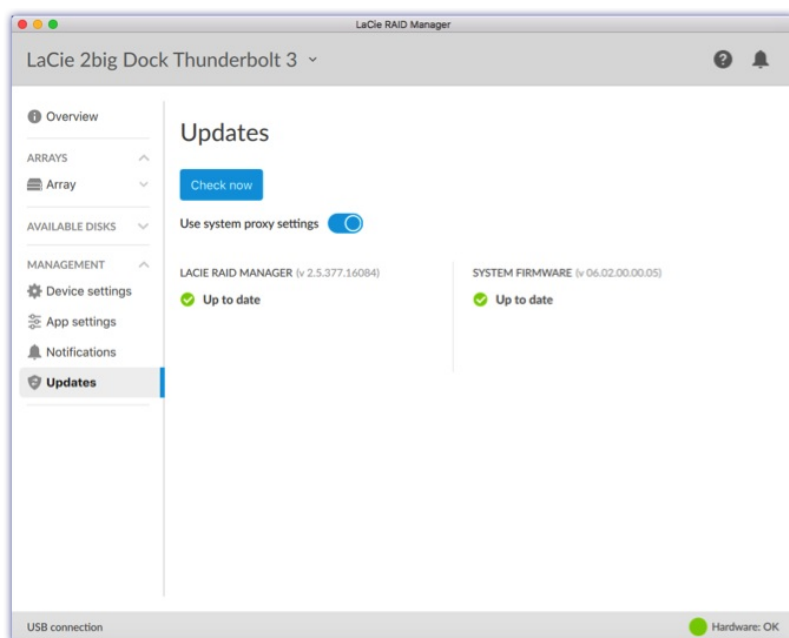

Check for updates

To check for updates, click **Check now**. Your computer must have access to the internet to check for updates.

Use system proxy settings

LaCie RAID Manager searches for updates using your PC or Mac's internet connection. If your computer uses

a proxy server for internet connection, make certain to enable **Use system proxy settings**.

Recent notifications

Click the Bell icon to view a list of recent events.

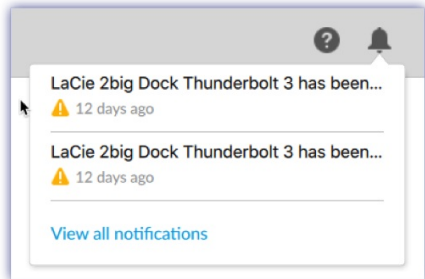

Click **View all notifications** to go to the Notifications screen.

Hard Drive Maintenance

Precautions

- “Hot-swapping” means that you can remove and replace hard drives while the enclosure is powered on.
- During operation, the hard drives should remain in their slots for optimal air flow. Airflow and fan performance are regulated by temperature.
- Observe all conventional ESD precautions when handling hard drives.

Replacing a hard drive

If a failed hard drive is under warranty, make certain to contact [LaCie support](#) to receive a replacement disk.

When adding new hard drives or replacing hard drives that are not under warranty, it's recommended that you select an HDD optimized for use with your 2big Dock. Click [here](#) for a list of model numbers that are compatible with LaCie Direct Attached Storage devices in the big family.

It's not necessary to power down the device to replace a single hard drive.

i **Important info:** Replace a faulty hard drive with a hard drive of equal or greater capacity.

i **Important info:** When handling hard drives, make sure that they are placed and stored on a cushioned surface.

1. Locate the hard drive you want to replace and place your index finger on the small hole on the right side of its disk tray.

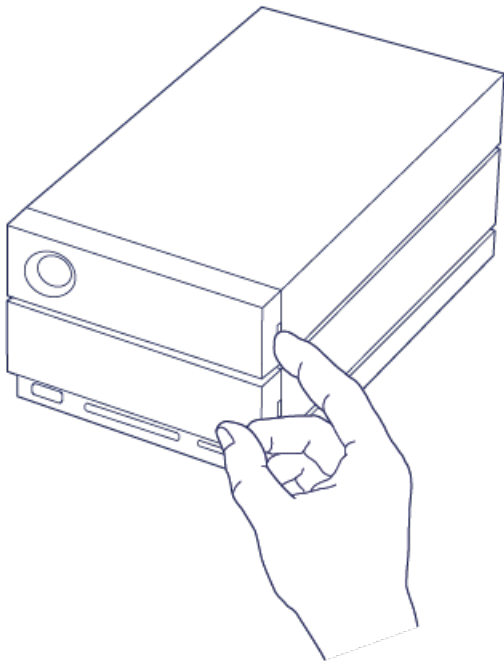

2. Gently pull your index finger away from the enclosure and maintain a firm grip as it unlocks the hard drive from the SATA connector. Once it is loose, hold the hard drive with both hands as you remove it from the slot.

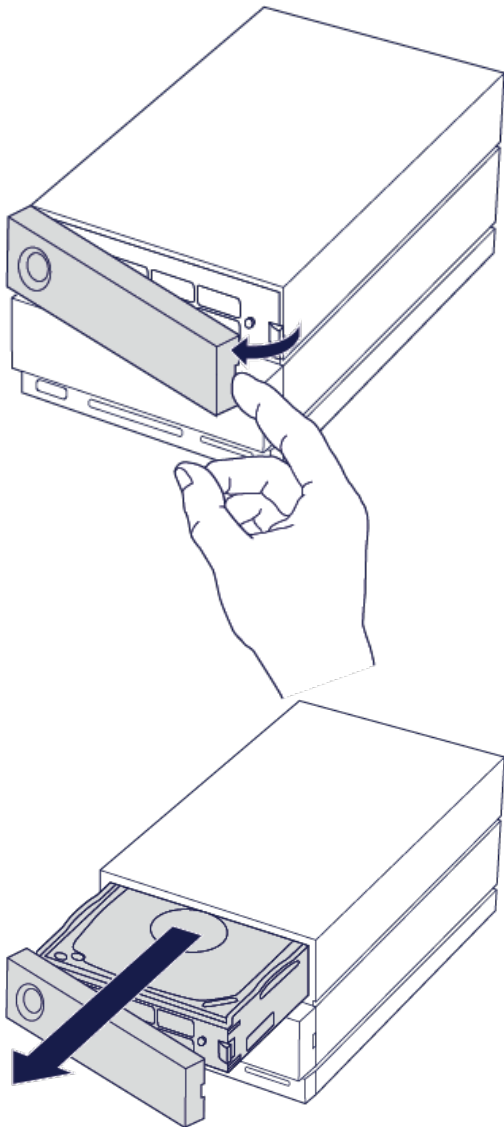

3. If you are replacing a failed hard drive with a full disk tray, skip to Step 4. Continue here if you are

replacing the hard drive using the same disk tray.

- Using a Phillips head screwdriver, carefully unfasten all four screws from their four slots.

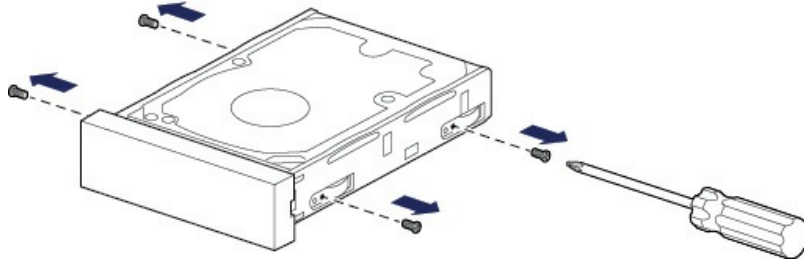

- Gently slide the disk out of the tray.

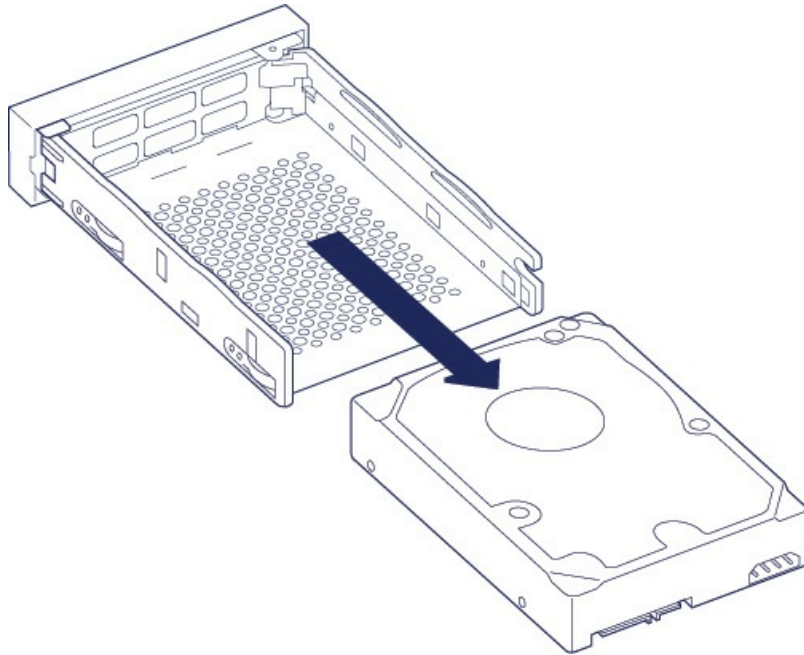

- Place the empty disk tray onto a flat work area with the handle on the bottom left.
- Many disks have a label on one side and the printed circuit board on the opposite side. With its label side facing up, gently place the hard disk within the disk tray. Keep the SATA connector facing to the right. The four screw slots should align with the disk's four screw holes.

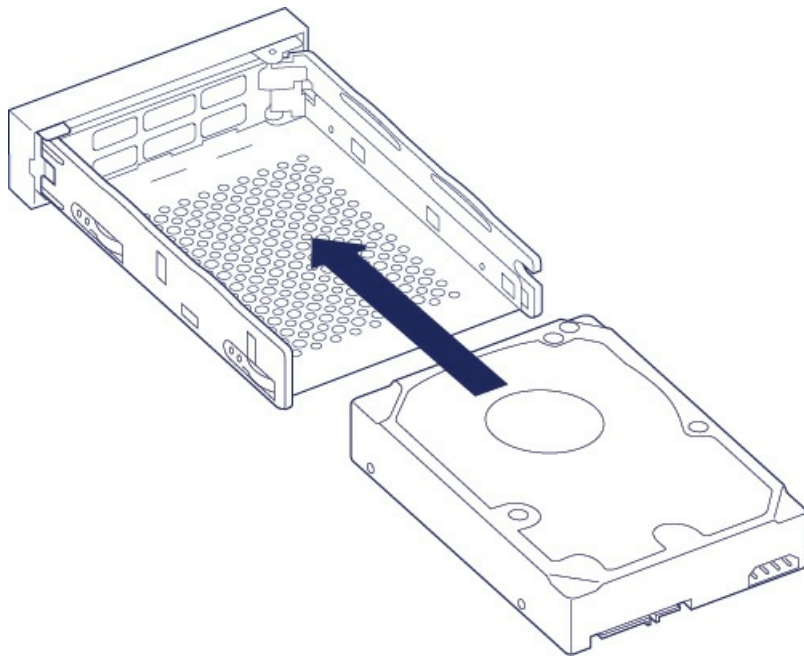

- Using a Phillips head screwdriver, carefully fasten all four screws into their four slots. Do not force the screws into the slots. Forcing the screws too tight into the slots can make it difficult to remove them later and strip the screws' teeth.

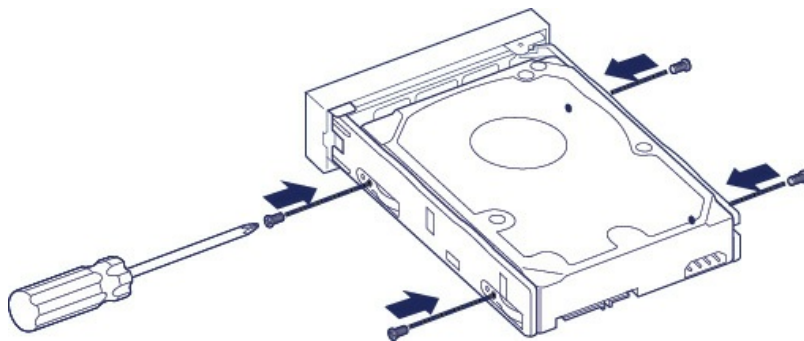

4. Carefully insert the full disk tray into the empty disk slot. Gently push the disk tray handle until you feel it snap into place.

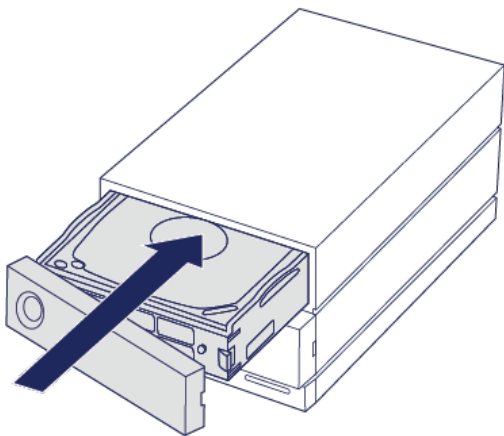

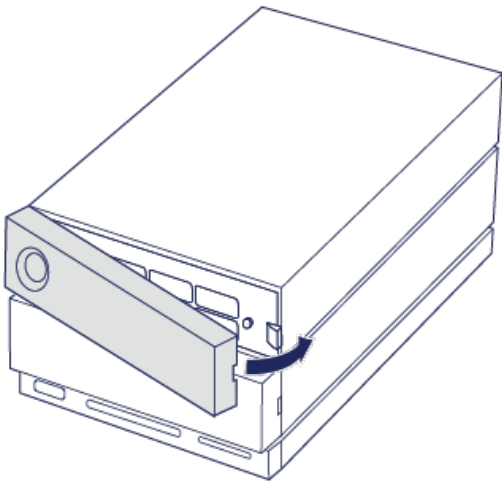

See [Manage RAID](#) for instructions on how to manage the RAID configuration.

When replacing hard drives that are members of an active RAID array, the hard drive LEDs blink red and blue indicating that the RAID is synchronizing data. You can continue to use the LaCie 2big Dock storage but performance is reduced until the synchronization is complete.

LaCie 2big Dock enclosure: non-serviceable components

The components inside the chassis are **NOT** hot-swappable and are **NOT** serviceable at any location outside of LaCie-approved service centers. **Removing the cover voids your product's warranty.** Additionally, removing, replacing or changing any part in the enclosure or, performing any action that involves the components in the enclosure, voids the product's warranty. If you are experiencing hardware errors or failure, contact [LaCie support](#) for assistance.

Formatting and Partitioning

When you format the drive, you're instructing your computer's operating system to erase data on the disks, check the disks for errors, and prepare the disks to receive new data. You might decide to format the drive in order to change file system formats (see below) and make the drive compatible with your PC or Mac operating system.



Note to Mac users: Your LaCie device is shipped factory formatted as HFS+ for Mac. The dual disks are configured for optimal performance using RAID 0.



Note to Windows users: When first connecting the device, the disks must be configured and formatted since Windows does not support HFS+. You must use LaCie RAID Manager to delete the current RAID array and create a new one. To learn more about using LaCie RAID Manager with your 2big Dock, see [Manage RAID](#). Once you've created the new array, you will need to partition and format it.



Caution: Formatting erases everything on the storage device. LaCie **strongly recommends** that you **back up** all data on your storage device before initiating the formatting process. LaCie is not responsible for any data lost due to formatting, partitioning, or using a LaCie storage device.

About file system formats

NTFS: Since it is the native file system for Windows, volumes created in NTFS are read and write enabled for computers running Windows. Mac OS can read NTFS volumes but cannot natively write to them.

Mac OS Extended (HFS+): The native hard drive file system for Mac. Windows cannot natively read or write to HFS+ (journaled) hard drives.

exFAT: Generally compatible with Mac and Windows. exFAT is not a journaled file system which means it can be more susceptible to data corruption when errors occur or the drive is not disconnected properly from the computer.

FAT32: Compatible with Mac and Windows. However, FAT32 is a legacy file system designed for low capacity hard drives and it is not recommended for modern hard drives or operating systems. A FAT32 partition can reach up to 32GB when formatted on a Windows PC.

How to choose the file system format

Use NTFS if:

...the storage device is connected to Windows PCs.

Use HFS+ if:

...the storage device is connected to Macs.

You can use exFAT if:

...the storage device is shared between Mac and Windows computers.

Use FAT32 if:

...the storage device is connected to older Windows and Mac computers. FAT32 is not recommended for modern operating systems and computers.

Formatting instructions

The steps below help you format and partition a storage device.



Note: Refer to your operating system's documentation for more information on formatting and partitioning storage devices.

Mac

OS X version 10.11 or later

1. Open the Finder and go to **Applications > Utilities > Disk Utility**.
2. In the sidebar to the left, select your LaCie 2big Dock drive.
3. Select **Erase**.
4. A dialog box opens. Enter a name for the drive. This will be the name displayed when the drive mounts.
5. For Format, select **OS X Extended (Journaled)**.
6. For Scheme, select **GUID Partition Map**.
7. Click **Erase**.
8. Disk Utility will format the drive. When it's finished, click **Done**.

OS X version 10.9 to 10.10

1. Open the Finder and go to **Applications > Utilities > Disk Utility**.
2. In the sidebar to the left, select the LaCie 2big Dock drive that shows the capacity.
3. In the Disk Utility window, select the **Partition** tab.
4. Under Partition Layout, select **1 partition**.
5. Enter a name for the drive. This will be the name displayed when the drive mounts.
6. For Format, select **OS X Extended (Journaled)**.
7. Click on **Options**. Select **GUID Partition Map**, and then click **OK**.
8. Click **Apply**.
9. A dialog appears advising you that this is a data destructive process and any data currently on the drive will be deleted.
10. Select **Partition** to complete the formatting process.

Windows

1. Make sure the storage device is connected to and mounted on the computer.

2. Go to Search and then type **diskmgmt.msc**. In the search results, double click **Disk Management**.
3. From the list of storage devices in the middle of the Disk Management window, locate your LaCie device.
4. The partition must be available to format. If it is currently formatted, right click on the partition and then choose **Delete**.
5. To create a new partition, right click on the volume and select **New Simple Volume**. Follow the on-screen instructions when the New Simple Volume Wizard appears.

Frequently Asked Questions

For help setting up and using your LaCie hard drive, review the frequently asked questions below. For additional support resources, go to [LaCie customer support](#).

All users

Problem: My file transfers are too slow.

Thunderbolt 3/USB

Q: Are both ends of the cable firmly attached?

A: Review troubleshooting tips for cable connections below:

- Check both ends of the cable and make sure they are fully seated in their respective ports.
- Try safely ejecting LaCie 2big Dock from your computer and then disconnect the cable. Wait 10 seconds and then reconnect LaCie 2big Dock to the computer.

Q: Are there other Thunderbolt 3 or USB devices connected to the same port or hub?

A: Disconnect other devices and see if the drive's performance improves.

Thunderbolt 3

Q: Is the device connected to a Thunderbolt 3 USB-C port on your computer or hub?

A: Connect LaCie 2big Dock to a USB-C port on your computer that supports Thunderbolt 3 devices. The lightning bolt icon that represents Thunderbolt 3 support should appear next to the USB-C port.

Q: Does your computer or operating system support Thunderbolt 3?

A: Consult your computer and operating system documentation for Thunderbolt 3 compatibility information.

USB

Q: Is the device connected to Hi-Speed USB 2.0 on your computer or hub?

A: If your hard drive is connected to a USB 2.0 port, the slower performance is normal. LaCie 2big Dock USB performance is significantly better when it is connected to a USB 3.1 port or a SuperSpeed USB 3.0 port. Otherwise, LaCie 2big Dock operates at slower USB transfer rates.

Problem: I connected LaCie 2big Dock to my computer but it does not power on and I cannot see the device in LaCie RAID Manager.

Q: Which cable and ports are connecting LaCie 2big Dock to the computer?

A: Make certain that the correct ports are connected by the correct cable. If you're connecting using Thunderbolt 3, make sure that one end of your Thunderbolt 3 cable is connected to one of the Thunderbolt 3 ports on LaCie 2big Dock, and the other end of the cable is connected to a Thunderbolt 3 port on your computer. A Thunderbolt 3 port is a USB-C port with a Thunderbolt icon next to it.

If your computer does not have a Thunderbolt 3 port, connect the USB 3.1 port on LaCie 2big Dock to a USB 3.1 port on your computer (using the Thunderbolt 3 cable). Please note that it is not possible to access the storage when connecting the Thunderbolt 3 port on LaCie 2big Dock to a USB-C port on a computer that does not support Thunderbolt 3. While it is possible to connect LaCie 2big Dock's USB 3.1 port to a Thunderbolt 3 port on a computer, the benefits offered by Thunderbolt 3 are lost. Such a connection only allows for using a single array at transfer rates up to 10Gb/s rather than Thunderbolt 3's potential of multiple arrays and transfer rates up to 40Gb/s.

If you see the storage using the USB connection but the Thunderbolt connection does not appear to work, confirm that LaCie RAID Manager is installed on your computer. The installer for LaCie RAID Manager includes an important driver that allows the computer to recognize the storage with Thunderbolt connections. The installer can be downloaded at [LaCie RAID Manager](#).

Problem: I want to change the RAID level.

Q: How do I change the RAID level?

A: You can manage the storage for LaCie 2big Dock using LaCie RAID Manager. To download the installer, go to [LaCie RAID Manager](#). For instructions how to use the application, see [Manage RAID](#).

Problem: I disconnected my computer from the LaCie 2big Dock during RAID synchronization or initialization.

Q: Can I disconnect my computer during RAID synchronization or initialization?

A: Yes. Synchronization and initialization continue uninterrupted when the computer disconnects from LaCie 2big Dock. Similarly, LaCie 2big Dock can be placed into power-saving mode or powered off during synchronization and initialization. Provided the same hard drives are in the enclosure, the operation continues once the device is powered on. For more information, see [Operation](#).

Problem: I have a USB-C hard drive that I want to add to the Thunderbolt 3 daisy chain.

Q: Can I attach my USB-C hard drive to a Thunderbolt 3 daisy chain?

A: Yes. Make certain to add the USB-C hard drive to the end of a Thunderbolt 3 daisy chain since USB devices do not include a second port to continue the chain. Please note that USB-C devices do not become Thunderbolt 3 devices when added to a Thunderbolt 3 daisy chain. The USB-C device can only provide performance within its potential. For example, a USB 3.1 Gen 1 hard drive added to the end of a Thunderbolt 3 daisy chain can reach up to 5Gb/s while a USB 3.1 Gen 2 hard drive can reach up to 10Gb/s.

Problem: I must password protect and/or encrypt my hard drive.

Q: Can I attach my USB-C hard drive to a Thunderbolt 3 daisy chain?

A: Yes, it is possible to protect the hard drive or individual folders and files with a password. There are many third-party solutions for password protection. However, LaCie cannot guarantee them since we do not test third-party applications.

Some versions of Windows have a built-in utility called Bitlocker that can protect hard drives with a password. For more information about Bitlocker, consult [Microsoft's support documentation](#).

Q: Can I encrypt my hard drive?

A: Yes, the hard drive can be encrypted. There are many third-party solutions for encryption. However, LaCie cannot guarantee them since we do not test third-party applications.

Some versions of Windows have a built-in utility called Bitlocker that can encrypt hard drives. For more information about Bitlocker, consult [Microsoft's support documentation](#)

Problem: I'm receiving file transfer error messages.

Q: Did you get an "Error -50" message while copying to a FAT32 volume?

A: When copying files or folders from a computer to a FAT32 volume, certain characters in the names cannot be copied. These characters include, but are not limited to: ? < > / \ :

Check your files and folders to ensure that these characters are not in the names.

If this is a recurring problem or you cannot find files with incompatible characters, consider reformatting the drive to NTFS (Windows users) or HFS+ (Mac users). See [Formatting and Partitioning](#).

Problem: DisplayPort to HDMI display does not work.

Q: Why does my HDMI display not work correctly when connected to the DisplayPort expansion port?

A: The DisplayPort 1.2 on your LaCie 2big Dock does not support DP++ to HDMI adapters. If you do not have a DP 1.2 to HDMI adapter but still want to connect to an HDMI display, it's recommended that you daisy chain your LaCie 2big Dock to the display using a USB-C to HDMI adapter (not included). This configuration is only possible if the LaCie 2big Dock is connected to your computer via a Thunderbolt cable.

Mac

Problem: The drive icon does not appear on my desktop.

Q: Is your Finder configured to hide hard drives on the desktop?

A: Go to Finder and then check **Preferences > General tab > Show these items on the desktop**. Confirm that **Hard Disks** is selected.

Q: Is your drive mounting in the operating system?

A: Open Disk Utility at **Go > Utilities > Disk Utility**. If the drive is listed in the left-hand column, check your

Finder preferences to see why it is not displayed on the desktop (review the question above).

Q: Does your computer's configuration meet the minimum system requirements for use with this drive?

A: Refer to the product packaging for the list of supported operating systems.

Q: Did you follow the correct installation steps for your operating system?

A: Review the installation steps in [Connect your LaCie 2big Dock Thunderbolt 3](#).

Windows

Problem: The drive icon doesn't appear in Computer.

Q: Is the drive listed in Device Manager?

A: All drives appear in at least one place in Device Manager.

Go to Search and enter Device Manager to launch it. Look in the Disk Drives section and, if necessary, click the plus sign to view the full list of devices. If you're uncertain that your drive is listed, safely unplug it and then reconnect it. The entry that changes is your LaCie hard drive.

Q: Is your drive listed next to an unusual icon?

A: Windows Device Manager usually provides information about failures with peripherals. While the Device Manager can assist with troubleshooting most problems, it may not display the exact cause or provide a precise solution.

An unusual icon next to the hard drive can reveal a problem. For example, an exclamation point, question mark, or X instead of the normal icon based on the type of device could indicate a problem. Right click on the icon and then choose **Properties**. The General tab provides a potential reason why the device is not working as expected.