

**LV 5770A**

MULTI MONITOR

<b>LV 5770SER03A</b>	TRI SYNC / COMPOSITE
<b>LV 5770SER03</b>	COMPOSITE VIDEO
<b>LV 5770SER08</b>	SDI INPUT
<b>LV 5770SER09(A)</b>	SDI INPUT / EYE
<b>LV 5770SER41</b>	DIGITAL AUDIO
<b>LV 5770SER42</b>	ANALOG AUDIO
<b>LV 5770SER43</b>	DIGITAL AUDIO

INSTRUCTION MANUAL

# TABLE OF CONTENTS

GENERAL SAFETY SUMMARY .....	I
1. INTRODUCTION .....	1
1.1 Scope of Warranty .....	1
1.2 Operating Precautions .....	1
1.2.1 Maximum Allowable Input Voltage .....	1
1.2.2 About Standby Mode .....	2
1.2.3 Mechanical Shock.....	2
1.2.4 Electrostatic Damage.....	2
1.2.5 About the Cabinet .....	2
1.2.6 Warming Up.....	2
1.2.7 Backup Battery .....	2
1.2.8 About the LCD Panel.....	3
1.3 About Trademarks and Licenses .....	3
1.4 Differences between the LV 5770SER03A and LV 5770SER03 .....	3
1.5 Differences between the LV 5770SER09A and LV 5770SER09 .....	3
1.6 About Terminology Used in this Manual.....	4
2. SPECIFICATIONS.....	5
2.1 General.....	5
2.2 Features.....	5
2.3 Specifications.....	9
2.3.1 SDI Video Signal Formats and Standards (LV 5770SER08 and LV 5770SER09A) .....	9
2.3.2 Embedded Audio Playback Format (LV 5770SER41/LV 5770SER43 and LV 5770SER08/LV 5770SER09A) .....	12
2.3.3 Analog Composite Signal Formats and Standards (LV 5770SER03A) .....	12
2.3.4 SDI I/O Connectors (LV 5770SER08 and LV 5770SER09A) .....	12
2.3.5 Analog Video I/O Connectors (LV 5770SER03A) .....	13
2.3.6 External Sync Signal Input Connectors (LV 5770SER03A, LV 5770SER08, and LV 5770SER09A).....	13
2.3.7 Audio I/O Connectors (LV 5770SER41, LV 5770SER42, and LV 5770SER43) .....	14
2.3.8 Video Output Connectors.....	15
2.3.9 Control Connectors.....	15
2.3.10 LCD .....	16
2.3.11 Screen Capture.....	16
2.3.12 Frame Capture (LV 5770SER08 and LV 5770SER09A) .....	16
2.3.13 Presets .....	17
2.3.14 Main Display Features .....	17
2.3.15 SDI Signal Video Waveform Display (LV 5770SER08 and LV 5770SER09A) .....	17
2.3.16 Analog Composite Signal Video Waveform Display (LV 5770SER03A) .....	19
2.3.17 SDI Signal Vector Waveform Display (LV 5770SER08 and LV 5770SER09A) .....	20
2.3.18 Analog Composite Signal Vector Waveform Display (LV 5770SER03A) .....	20
2.3.19 SDI Signal 5-Bar Display (LV 5770SER08 and LV 5770SER09A).....	21
2.3.20 SDI Signal Picture Display (LV 5770SER08 and LV 5770SER09A) .....	21

2.3.21	Analog Composite Signal Picture Display (LV 5770SER03A).....	23
2.3.22	SDI Signal 3D-Assist Display (LV 5770SER08 and LV 5770SER09A) .....	23
2.3.23	Digital Audio Display (LV 5770SER41 and LV 5770SER43).....	24
2.3.24	Analog Audio Display (LV 5770SER42).....	27
2.3.25	SDI Signal Status Display (LV 5770SER08 and LV 5770SER09A).....	27
2.3.26	Analog Composite Signal Status Display (LV 5770SER03A).....	29
2.3.27	Event Log (LV 5770SER08, LV 5770SER09A, LV 5770SER41, and LV 5770SER43) ..	29
2.3.28	SDI Analysis Features (LV 5770SER08 and LV 5770SER09A).....	30
2.3.29	SDI Ancillary Data List Display (LV 5770SER08 and LV 5770SER09A).....	31
2.3.30	Lip Sync Measurement (LV 5770SER41/LV 5770SER43 and LV 5770SER08/LV 5770SER09A).....	31
2.3.31	SDI Closed Caption Packet Display (LV 5770SER08 and LV 5770SER09A) .....	32
2.3.32	Eye Pattern Display (LV 5770SER09A).....	33
2.3.33	Jitter Display (LV 5770SER09A).....	34
2.3.34	Eye Pattern and Jitter Detection (LV 5770SER09A).....	35
2.3.35	Time Display Feature.....	35
2.3.36	Alarm Output Feature .....	36
2.3.37	Front Panel.....	36
2.3.38	General Specifications.....	36
<b>3.</b>	<b>PANEL DESCRIPTION.....</b>	<b>37</b>
3.1	Front Panel.....	37
3.2	Rear Panel.....	39
<b>4.</b>	<b>BEFORE YOU BEGIN MEASURING .....</b>	<b>41</b>
4.1	Cover/Inlet Stopper .....	41
4.1.1	Attaching the Cover/Inlet Stopper .....	41
4.1.2	Removing the Cover/Inlet Stopper.....	41
4.2	Turning the Instrument On and Off .....	42
4.3	Optional Units .....	42
4.4	Signal I/O.....	42
4.4.1	SDI Signal Input (LV 5770SER08 and LV 5770SER09A) .....	42
4.4.2	SDI Signal Output (LV 5770SER08 and LV 5770SER09A).....	44
4.4.3	Picture Monitor Output (LV 5770SER08 and LV 5770SER09A) .....	44
4.4.4	External Sync Signal Input (LV 5770SER03A, LV 5770SER08, and LV 5770SER09A). 45	
4.4.5	Composite Signal I/O (LV 5770SER03A).....	48
4.4.6	Digital Audio Signal I/O (LV 5770SER41 and LV 5770SER43).....	48
4.4.7	Analog Audio Signal I/O (LV 5770SER42) .....	49
4.4.8	DVI-D Output.....	50
4.5	General Display Explanation.....	51
4.6	Panel Operation Basics .....	52
4.6.1	Displaying the Function Menu .....	52
4.6.2	Function Menu Operations .....	53
4.6.3	Tab Menu Operations .....	53
4.6.4	Enabling and Releasing the Key Lock .....	54
4.6.5	Operating the Shortcut Key .....	55

5.	BASIC OPERATING PROCEDURES .....	56
5.1	Selecting the Display Format .....	57
5.2	Selecting the Display Area .....	58
5.3	Selecting the Input Signal .....	58
5.4	Selecting the Input Channel .....	59
5.5	Selecting the Display Mode .....	59
6.	DETAILED MEASUREMENT EXAMPLES .....	61
6.1	SDI Signal Measurement .....	61
6.2	SDI Signal Eye Pattern Measurement .....	62
6.3	Composite Signal Measurement .....	62
6.4	Embedded Audio Signal Measurement .....	63
6.5	External Digital Audio Signal Measurement .....	64
6.6	Analog Audio Signal Measurement .....	65
6.7	Embedded Audio Signal Output .....	66
6.8	Analog Audio Signal Output .....	67
7.	SYSTEM SETTINGS .....	68
7.1	I/O Settings .....	69
7.1.1	Configuring SDI Input Settings (LV 5770SER08 and LV 5770SER09A) .....	69
7.1.2	Rear Panel Settings .....	72
7.2	Configuring the LV 5770A .....	75
7.2.1	General Settings .....	75
7.2.2	Configuring Ethernet Settings .....	78
7.2.3	Remote Control Settings .....	80
7.2.4	Setting the Date and Time .....	81
7.3	Displaying System Information .....	82
7.4	Setting the Shortcut Key .....	82
7.5	Configuring License Settings .....	83
7.6	Turning Off the LCD Panel .....	83
7.7	Initializing Settings .....	83
7.8	Adjusting the Backlight .....	84
8.	CAPTURE FEATURE .....	85
8.1	Screen Capture .....	86
8.1.1	Taking a Screen Capture of the Display .....	86
8.1.2	Displaying Screen Capture Data .....	86
8.1.3	Saving to a USB Memory Device .....	87
8.1.4	Displaying Screen Capture Data Saved to a USB Memory Device .....	88
8.1.5	Deleting Screen Capture Data Saved to a USB Memory Device .....	89
8.2	Frame Capture (LV 5770SER08 and LV 5770SER09A) .....	90
8.2.1	Capturing Frame Data .....	90
8.2.2	Displaying Frame Capture Data .....	92
8.2.3	Saving to a USB Memory Device .....	92
8.2.4	Displaying Frame Capture Data Saved to a USB Memory Device .....	94

8.2.5	Deleting Frame Capture Data Saved to a USB Memory Device.....	95
9.	PRESET FEATURE.....	96
9.1	Registering Presets.....	96
9.2	Loading Presets.....	98
9.3	Deleting Presets.....	98
9.4	Copying All Presets.....	99
9.4.1	Copying All Presets from the LV 5770A to a USB Memory Device.....	99
9.4.2	Copying All Presets from a USB Memory Device to the LV 5770A.....	100
10.	REMOTE CONTROL.....	101
11.	ETHERNET REMOTE CONTROL.....	106
11.1	TELNET.....	106
11.1.1	Procedure.....	106
11.1.2	How to Enter Commands.....	107
11.1.3	TELNET Commands.....	108
11.2	FTP.....	131
11.2.1	Procedure.....	131
11.2.2	How to Enter Commands.....	132
11.2.3	FTP Commands.....	133
11.3	SNMP.....	134
11.3.1	SMI Definitions.....	134
11.3.2	Procedure.....	134
11.3.3	Standard MIB.....	136
11.3.4	Enterprise MIB.....	141
11.3.5	Extended TRAP (Variable Binding List).....	181
11.4	HTTP Server Feature.....	184
11.4.1	Operating Environment.....	184
11.4.2	Precautions.....	184
11.4.3	Procedure.....	184
11.5	SNTP Client Function.....	188
11.5.1	Procedure.....	188
11.5.2	Time Adjustment Value.....	189
12.	MENU TREES.....	190
12.1	System Menu.....	190
12.2	Capture Menu.....	193
12.3	Preset Registration Menu.....	194
12.4	Preset Load Menu.....	195
13.	CHANGE HISTORY OF THE SOFTWARE.....	196

# GENERAL SAFETY SUMMARY

## ■ Read This before Using the Instrument

This instrument should only be used by persons with sufficient knowledge of electronics who thoroughly understand the contents of this manual.



This instrument is not designed or manufactured for households or ordinary consumers. If unqualified personnel are to use the instrument, be sure the instrument is handled under the supervision of qualified personnel (those who have electrical knowledge). This is to prevent the possibility of personal injury or damage to the instrument.

## ■ Note about Reading This Manual

The contents of this manual contain specialized terminology and may be difficult to understand. If you have any questions about the contents of this manual, please contact your local LEADER agent.

## ■ Symbols and Terms

The following symbols and terms are used in this instruction manual and on the instrument to indicate important warnings and notes.

<p>&lt;Symbol&gt;</p> 	<p>This symbol appears in this instruction manual and on the instrument to indicate an area where improper handling could result in personal injury, damage to the instrument, or malfunction of the instrument or devices connected to it.</p> <p>When you encounter this symbol on the instrument, be sure to refer to the information in this instruction manual that corresponds to the area that the symbol marks.</p>
<p>&lt;Term&gt;</p> 	<p>Ignoring the precautions that this term indicates could lead to death or serious injury.</p>
<p>&lt;Term&gt;</p> 	<p>Ignoring the precautions that this term indicates could lead to personal injury or damage to the instrument.</p>

# GENERAL SAFETY SUMMARY

Read the warnings and information below thoroughly to avoid death, personal injury, and damage and deterioration of the instrument.



## ■ Warnings Concerning the Case and Panels

Do not remove the instrument's case or panels for any reason. Touching the internal components of the instrument could lead to fire or electric shock.

Also, do not allow foreign materials, such as liquids, combustible matter, and metal, to enter the instrument. Turning the instrument on when such materials are inside it could lead to fire, electric shock, damage to the instrument, or some other accident.

## ■ Installation Environment

### • Operating Temperature Range

Use this instrument in a 0 to 40 °C environment. Using the instrument with its vents blocked or in a high temperature environment could lead to fire.

Drastic changes in temperature, such as might be caused by moving the instrument between two rooms with different temperatures, can damage the instrument by causing condensation to form within it. If there is a possibility that the instrument has condensation within it, wait for approximately 30 minutes before turning on the power.

### • Operating Humidity Range

Use this instrument in an environment whose relative humidity is 85 % or less where there is no threat of condensation forming.

Also, do not operate this instrument with wet hands. Doing so could lead to electric shock or fire.

### • Do Not Operate in an Explosive Atmosphere

Using this instrument in an environment where flammable gasses, explosive gasses, or steam is emitted or stored could lead to an explosion or fire. Do not use the instrument in such an environment.

### • Do Not Insert Foreign Materials

If foreign materials, such as metal, flammable objects, or liquid are allowed into the instrument (through the vents for example), fire, electric shock, damage to the instrument, or some other accident may result.

## ■ If You Notice Something Wrong during Operation

If you notice smoke, fire, a strange smell, or something else that is wrong with the instrument while you are operating it, stop operation immediately. Failing to do so could lead to fire. Turn off the power switch, and remove the power cord from the outlet. After making sure that fire has not spread anywhere, contact your local LEADER agent.

# GENERAL SAFETY SUMMARY



## ■ Warnings Concerning the Power Source

Do not use a power source with a voltage other than the rated power source voltage for the instrument. Doing so could lead to fire.

Confirm the voltage of the power source before you connect the power cord to it.

Only use a power source whose frequency is 50/60 Hz.

Use a power cord that is appropriate for the voltage of the power source. Also, use a power cord that meets the safety standards of the country that you are using it in.

Using a power cord that does not meet the standards could lead to fire. If the power cord is damaged, stop using it, and contact your local LEADER agent. Using a damaged power cord could lead to electrical shock or fire.

When removing the plug from the power outlet, do not pull on the cord. Pull from the plug.

## ■ Warnings Concerning Grounding

The instrument has a ground terminal to protect the user and the instrument from electric shock. Ensure that the instrument is properly grounded for safe operation.

## ■ Warnings Concerning the Panel

Sections of the panel are made out of glass. If the glass breaks, the broken glass may lead to injury. Do not apply a strong shock to the panel, cut it with sharp metal, or damage it in any similar manner.



## ■ Cautions Concerning the Input and Output Connectors

To avoid damaging the instrument, only apply signals to the input connectors that conform to the specifications in this instruction manual. Do not short or apply external voltage to the output connectors. Doing so could damage the instrument.

## ■ Cautions Concerning the Ethernet Port

When you are connecting the instrument to the communication provider's equipment, connect to the Ethernet port through a hub that is authorized for use in the country that you are using the instrument in.



# GENERAL SAFETY SUMMARY

## ■ Calibration and Repairs

This instrument has been carefully examined at the factory to ensure that its performance is in accordance with the standards. However, because of factors such as parts wearing out over time, the performance of the instrument may degrade. To ensure stable performance, we recommend that you have the instrument calibrated regularly. Also, if the instrument malfunctions, repairs are necessary. For repairs and calibration, contact your local LEADER agent.

## ■ Routine Maintenance

When you clean the instrument, remove the power plug from the outlet.

Do not use thinner or benzene when you clean the instrument's case, panels, or knobs. Doing so could lead to paint chipping and the corrosion of plastic components. To clean the case, panels, and knobs, use a soft cloth with mild detergent, and wipe gently. While cleaning, make sure that foreign materials, such as water and detergent, do not enter the instrument. If liquid or a metal object enters into the instrument, fire or electric shock may result.

## ■ About the European WEEE Directive

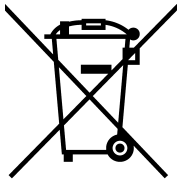

This instrument and its accessories are subject to the European WEEE Directive.

Follow the applicable regulations of your country or region when discarding this instrument or its accessories. Follow the EU Battery Directive when discarding the batteries that you removed from this instrument.

(WEEE stands for Waste Electrical and Electronic Equipment.)

---

---

Follow the warnings and precautions that have been listed in this section to use the instrument correctly and safely. Precautions are also contained in various other sections of this instruction manual. To use the instrument correctly, be sure to follow those precautions as well.

If you have any questions or comments about this instruction manual, please contact your local LEADER agent.

---

---

# 1. INTRODUCTION

Thank you for purchasing this LEADER instrument. To use this instrument safely, read this instruction manual thoroughly, and make sure that you know how to use the instrument properly.

If some point about the operation of this instrument is still unclear after you have read this instruction manual, refer to the contact information on the back cover of the manual to contact LEADER, or contact your local LEADER agent.

After you have finished reading this manual, keep it in a convenient place so that you can refer to it when necessary.

## 1.1 Scope of Warranty

This LEADER instrument has been manufactured under the strictest quality control guidelines.

LEADER shall not be obligated to furnish the following free services during the warranty period.

1. Repair of malfunction or damages resulting from fire, natural calamity, or improper voltage applied by the user.
2. Repair of an instrument that has been improperly repaired, adjusted, or modified by personnel other than a factory-trained LEADER representative.
3. Repair of malfunctions or damages resulting from improper use.
4. Repair of malfunctions caused by devices other than this instrument.
5. Repair of malfunctions or damages without the presentation of a proof of purchase or receipt bill for the instrument.

## 1.2 Operating Precautions

### 1.2.1 Maximum Allowable Input Voltage



CAUTION

The maximum signal voltage that can be applied to the input connectors is indicated below. Do not apply excessive voltage to the connectors. Doing so may damage the device or lead to injury.

Table 1-1 Maximum allowable input voltage

Input Connector		Maximum Allowable Input Voltage
LV 5770A	REMOTE	0 to +5 V
LV 5770A	EXT REF	±5 V (DC + peak AC)
LV 5770SER03A	TRI SYNC/COMPOSITE INPUT	±5 V (DC + peak AC)
LV 5770SER08 LV 5770SER09	SDI INPUT	±2 V (DC + peak AC)
LV 5770SER09A	SDI INPUT	0 to +12V (DC) ±1V (AC)
LV 5770SER41 LV 5770SER43	DIGITAL AUDIO IN	±5 V (DC + peak AC)
LV 5770SER42	ANALOG AUDIO	+24 dBu

1.2.2 About Standby Mode



Even if you press the power switch to turn off this instrument, the instrument remains in standby mode as long as the power cord is connected to the outlet. In standby mode, some of the internal circuits operate and may generate heat. Unless necessary, keep the power cord disconnected from the outlet.

1.2.3 Mechanical Shock

This instrument contains sensitive components, so it may be damaged if it is dropped or otherwise exposed to a strong shock.

1.2.4 Electrostatic Damage

Electronic components can be damaged by static discharge. Static electricity can build up in the core wire of a coaxial cable. Before connecting a coaxial cable to the instrument, short the core wire of the cable with the external conductor.

1.2.5 About the Cabinet

If you are using a cabinet, be sure to use the specified model number of cabinet. Please be aware that you cannot attach the instrument to any of the old cabinets with the serial numbers listed below.

LR 2404, LR 2427, LR 2427A,  
LR 2400-AI, LR 2400-AM, LR 2400-VI, LR 2400-VM, or LR 2700-I

1.2.6 Warming Up

To ensure more accurate measurements, turn on the instrument approximately 30 minutes before you intend to use it to allow its internal temperature to stabilize.

1.2.7 Backup Battery

This instrument has a last-memory feature. When you turn the power on, the instrument starts with the panel settings that were in use the last time that it was turned off. If the backup battery is out of power, the message “The last memory feature is disabled.” will be displayed, and this feature will no longer work.

To continually use the last-memory feature, we recommend that you replace the backup battery with a new one every five years after you purchase the instrument. You cannot replace the backup battery yourself. Contact your local LEADER agent.

### 1.2.8 About the LCD Panel

There may be a small number of pixels in the LCD panel that do not light or are always on. Note that this is not a malfunction.

The LCD panel supports a large number of video signals. SDI input signals are displayed asynchronously on the LCD. Therefore, images may appear to flicker on the waveform and picture displays.

In addition, the input SDI signal is temporarily stored in frame memory and is loaded by using the LCD display synchronization signal—which is not synchronized with the input SDI signal. Therefore, because frame skip—which skips over frames in the memory—and frame repeat—which reads the same frames of the memory twice—occur, the image may appear to flicker.

### 1.3 About Trademarks and Licenses

- The company and product names in this document are trademarks or registered trademarks of their respective holders.
- The MD5 algorithm, which is used by this instrument, was developed by RSA Security Inc. in the United States. This algorithm is available on a license-free and patent-free basis.

### 1.4 Differences between the LV 5770SER03A and LV 5770SER03

The LV 5770SER03A has the following additional feature that is not available on the LV 5770SER03.

- HD Tri-Level Sync Signal Input

This manual explains the LV 5770SER03A. Note that if you are using the LV 5770SER03, some of the information in this manual will not apply.

### 1.5 Differences between the LV 5770SER09A and LV 5770SER09

The LV 5770SER09A has the following additional features that are not available on the LV 5770SER09.

- Equivalent cable length measurement
- DC offset measurement

This manual explains the LV 5770SER09A. Note that if you are using the LV 5770SER09, some of the information in this manual will not apply.

## 1.6 About Terminology Used in this Manual

- **Single Input Mode**

This refers to the mode in which the SIM key is off. Press the A and B keys to switch between measuring the signal that is being applied to SDI INPUT A and the signal that is being applied to SDI INPUT B, respectively.

- **Simul Mode**

This refers to the mode in which the SIM key is on. The signals that are being applied to SDI INPUT A and SDI INPUT B are measured simultaneously.

- **1-Screen Display**

This refers to the mode in which the MULTI key is off. Only the area that you select by pressing keys 1 to 4 is displayed.

- **Multi-Screen Display (2-screen multi display and 4-screen multi display)**

This refers to the mode in which the MULTI key is on. You can set the number of screens that are displayed (two or four) in the system settings.

On the 2-screen multi display, you can display areas 1 and 2 or areas 3 and 4.

On the 4-screen multi display, you can display areas 1 to 4.

- **About the Input Format**

With some exceptions, the input formats are written in this manual as shown below.

Table 1-2 Input format

Name	Description
HD	HD-SDI
SD	SD-SDI
HD dual link	HD-SDI dual link
3G-A	3G-SDI level A
3G-B	3G-SDI level B
3G-B (2map)	3G-SDI level B 2mapping
3G	General term representing 3G-A, 3G-B, and 3G-B (2map)

- **Underline ( \_ )**

Underlined options indicate the default values.

## 2. SPECIFICATIONS

### 2.1 General

The LV 5770A is a waveform monitor that supports 3G-SDI, HD dual link, HD-SDI, and SD-SDI signals. It is light weight and comes at a low cost but has a variety of technically advanced features including simultaneous monitoring of two SDI signals, lip sync measurement, and ANC data analysis.

A variety of optional units are available, and installing combinations of these units in the instrument enables the various features.

LV 5770SER03A (TRI SYNC/COMPOSITE):	Tri-level sync and composite input
LV 5770SER08 (SDI INPUT):	SDI input (*1)
LV 5770SER09A (SDI INPUT/EYE):	SDI input with eye pattern display feature (*1)
LV 5770SER41 (DIGITAL AUDIO):	Digital audio I/O (*2)
LV 5770SER42 (ANALOG AUDIO):	Analog audio I/O (*3)
LV 5770SER43 (DIGITAL AUDIO):	Digital audio I/O (*2)

\*1 The LV 5770SER08 and LV 5770SER09A cannot be installed in the instrument at the same time.

\*2 The LV 5770SER41 and LV 5770SER43 cannot be installed in the instrument at the same time. The Dolby option, which enables the measurement of Dolby E and Dolby Digital signals, can be installed in the LV 5770SER41 or LV 5770SER43.

\*3 The LV 5770SER41 or LV 5770SER43 is required for the LV 5770SER42 to operate.

### 2.2 Features

- **3G-SDI Compatible 2-Channel Simultaneous Display (LV 5770SER08 and LV 5770SER09A)**

The LV 5770A is equipped with a pair of SDI input connectors that support 3G-SDI, HD dual link, HD-SDI, and SD-SDI signals. The two input signals can be displayed simultaneously. Even when one of the input signals is not being displayed, the LV 5770A still monitors the undisplayed signal for errors. In addition, the LV 5770A is equipped with SDI output connectors that can generate serial reclocked SDI signals from the input SDI signals. The A/B output connector generates the reclocked signal of the SDI signal applied to channel A or channel B. The output that is generated from this connector is switched between the two channels whenever an input key (A or B) is pressed.

- **Rich Assortment of Display Features**

Not only does the LV 5770A have essential displays for video signal quality monitoring, such as a video signal waveform display and a vector display, it also has a rich assortment of other display features such as a picture display, 5-bar display, and status display. (LV 5770SER03A, LV 5770SER08, and LV 5770SER09A)

The audio display includes a loudness display feature that is based on ITU standards. In addition, a loudness chart, level meters of each channel(\*1), and peak values (\*1) can be displayed simultaneously. Simultaneous loudness measurement of two audio sources (\*1) is also possible. (These features are available on the LV 5770SER41 and LV 5770SER43. Features marked as \*1 are available only on the LV 5770SER43.)

## 2. SPECIFICATIONS

- **Wide Variety of Display Formats (LV 5770SER08 and LV 5770SER09A)**

In the video signal waveform display, vector display, and picture display, the LV 5770A can display up to two input SDI signals on top of each other or side by side. This makes it suitable for adjusting the gain and black balance values of two video signals. In the video signal waveform and vector displays, the LV 5770A can make different input channels easier to see by displaying them using different colors.

- **Extremely Flexible Display Layouts**

The 1-screen display feature can be used to show each of the different displays on a single screen, or the 4-screen multi display feature can be used to divide the screen into four areas with a different display shown in each area. The video signal waveform display, picture display, audio level meter display, and histogram display can be shown as a thumbnail display on the 1-screen display.

- **Capture Feature**

A screen capture feature that captures the screen as still images, a frame capture feature that captures single frames of SDI signals, and an error capture feature that automatically detects and captures error frames are available.

Not only can captured data be displayed by the LV 5770A, but it can also be compared with an input signal or saved to a USB memory device. It is easy to view the saved data on a PC.

- **XGA Display and DVI-D Output**

The LCD display is a 6.5-inch XGA screen (the effective resolution is 1024 × 768).

In addition, the screen images are transmitted from a DVI-D connector that supports single link TMDS, so the screen image can be displayed larger than is possible on the LV 5770A through the use of an external LCD.

- **Picture Monitor Output (LV 5770SER08 and LV 5770SER09A)**

The input SDI signal can be generated as an 8-bit signal. Regardless of the SDI input signal, the output format can be set to YCbCr 4:2:2, YCbCr 4:4:4, or RGB 4:4:4.

- **3D Assist Display (LV 5770SER08 and LV 5770SER09A)**

3D video signals can be evaluated by applying the video signal for the left eye to channel A and the video signal for the right eye to channel B. The available picture display formats are anaglyph, convergence, overlay, wipe, checker, and flicker.

- **CINELITE (LV 5770SER08 and LV 5770SER09A)**

You can use the cursor to select any 3 points and display their luminance information using f-Stop numbers, percentage values, or level values. You can choose to analyze a single pixel or a small area by setting the size of the measured area to 1 pixel or to the average value for 9 or 81 pixels.

Furthermore, the CINELITE Advanced feature makes it possible to synchronize measurements with the video signal waveform display and vector display.

- **CINEZONE (LV 5770SER08 and LV 5770SER09A)**

You can display the luminance levels in the picture with different colors. This allows you to quickly determine the overall luminance distribution in the picture, and it makes it easy to spot overexposure, underexposure, and different luminance levels in dark areas.

- **SDI Signal Data Analysis Feature (LV 5770SER08 and LV 5770SER09A)**

On the status display, SDI signal transmission errors and various errors related to the embedded audio signal and ancillary data can be detected. In addition, the LV 5770A has event log, data dump, and external sync signal and SDI signal phase difference display features for analyzing SDI signals. Ancillary data is displayed along with the embedded line numbers and numbers of the corresponding standards in a list. This makes it possible to display detailed analyses.

- **Timecode Display (LV 5770SER08 and LV 5770SER09A)**

The LTC and VITC that are embedded in an SDI signal and the D-VITC that is embedded in an SD-SDI signal can be displayed. The timecode can also be used for time stamps in the event log.

- **Superimposing of English Closed Captions (LV 5770SER08 and LV 5770SER09A)**

The English closed captions (EIA-608, EIA-708, or VBI) that are embedded in an SDI signal can be superimposed over the image on the picture screen.

- **External Control Connectors**

The LV 5770A has two external control connectors: an Ethernet port and a remote control connector.

By connecting the Ethernet interface to a PC, you can control the LV 5770A remotely over TELNET, transfer files over FTP, control the LV 5770A remotely and detect errors over SNMP, and control the LV 5770A over HTTP. You can also connect to the separately-sold LV 7770-01 (REMOTECONTROLLER). (You cannot use TELNET and the LV 7770-01 at the same time.)

The remote control connector can be used to load presets, switch the input signal, and transmit errors.

- **Eye Pattern Display (LV 5770SER09A)**

When the eye pattern display option is installed in the LV 5770A, the LV 5770A can display the eye pattern waveforms and jitter waveforms of 3G-SDI, HD dual link, HD-SDI, and SD-SDI signals. (Channel A or B, whichever is selected, is displayed.)

An eye pattern's amplitude, rise time, fall time, DC offset, timing jitter, current jitter, rising edge overshoot, and falling edge overshoot can be measured automatically.

- **Digital Audio I/O (LV 5770SER41 and LV 5770SER43)**

When the digital audio I/O option is installed in the LV 5770A, the LV 5770A can display the external digital audio in addition to the embedded audio. The eight I/O connectors—16 channels—can be switched between input and output in groups of four connectors—8 channels. Therefore, the LV 5770A can also be used to extract and transmit the embedded audio's digital audio.

(To measure embedded audio, the LV 5770A must have the LV 5770SER08 or LV 5770SER09A installed.)



## 2. SPECIFICATIONS

- **Analog Audio I/O (LV 5770SER42)**

The addition of the analog audio I/O option enables the LV 5770A to display analog audio. In addition, the option is equipped with output pins, which can be used to generate the analog audio that corresponds to the audio signal displayed on the screen. The functionality of the option can be switched between input and output through settings. (This option requires the LV 5770SER41 or LV 5770SER43.)

- **Dolby Option (LV 5770SER41 and LV 5770SER43)**

The addition of the Dolby option enables the LV 5770A to decode and display the Dolby E or Dolby Digital signals that are compressed in embedded audio or digital audio signals.

- **Analog Composite Input (LV 5770SER03A)**

The addition of the analog composite input option enables the LV 5770A to display the video signal waveforms of NTSC, PAL, and HD tri-level sync signals, display vectors (NTSC and PAL only), measure SCH (NTSC and PAL only), and measure phase differences against external signals.

(For phase difference measurement, an external sync signal that is synchronized and of the same format as the input signal is necessary.)

- **Remote Controller (LV 7770-01; sold separately)**

Equipped with keys that correspond to the front panel keys of the LV 5770A. They can be used to remotely control the LV 5770A via Ethernet.

(You cannot use TELNET while you are using the LV 7770-01.)

- **Carrying Case (Sold separately)**

Use the carrying case (sold separately) when moving the LV 5770A.

- **Rack Mount Adapter (Sold separately)**

Use the rack mount adapter (sold separately) when rack-mounting the LV 5770A.

## 2. SPECIFICATIONS

### 2.3 Specifications

#### 2.3.1 SDI Video Signal Formats and Standards (LV 5770SER08 and LV 5770SER09A)

##### Bit Rate

3G-SDI	2.970 Gbps or 2.970/1.001 Gbps
HD-SDI	1.485 Gbps or 1.485/1.001 Gbps
SD-SDI	270 Mbps

Table 2-1 SD-SDI video signal formats and standards

Color System	Quantization	Scanning	Frame (Field) Rates	Compliant Standard
YCbCr 4:2:2	10 bits	525i	59.94	SMPTE ST 259
		625i	50	

Table 2-2 HD-SDI video signal formats and standards

Color System	Quantization	Scanning	Frame (Field) Rates	Compliant Standard
YCbCr 4:2:2	10 bits	1080i	60/59.94/50	SMPTE ST 274
		1080p	30/29.97/25/24/23.98	SMPTE ST 292
		1080PsF	30/29.97/25/24/23.98	
		720p	60/59.94/50/30/29.97/25/24/23.98	SMPTE ST 296 SMPTE ST 292

Table 2-3 HD dual link video signal formats and standards

Color System	Quantization	Scanning	Frame (Field) Rates	Compliant Standard
YCbCr 4:2:2	10 bits	1080p	60/59.94/50	SMPTE ST 372 (1920 × 1080)
		1080PsF	30/29.97/25/24/23.98	
	12 bits	1080p	30/29.97/25/24/23.98	
		1080PsF	30/29.97/25/24/23.98	
YCbCr 4:4:4	10 bits	1080p	30/29.97/25/24/23.98	
		1080PsF	30/29.97/25/24/23.98	
		1080i	60/59.94/50	
	12 bits	1080p	30/29.97/25/24/23.98	
		1080PsF	30/29.97/25/24/23.98	
		1080i	60/59.94/50	
RGB 4:4:4	10 bits	1080p	30/29.97/25/24/23.98	
		1080PsF	30/29.97/25/24/23.98	
		1080i	60/59.94/50	
	12 bits	1080p	30/29.97/25/24/23.98	
		1080PsF	30/29.97/25/24/23.98	
		1080i	60/59.94/50	
		1080p	24/23.98	(2048 × 1080)
		1080PsF	24/23.98	

\* When these signals are displayed, phase differences of up to 100 clocks (approx. 1.4 μs) between links A and B are automatically corrected.  
1080p/60, 1080p/59.94, and 1080p/50 signals can not be used in external sync mode.

## 2. SPECIFICATIONS

Table 2-4 3G-SDI level A video signal formats and standards

Color System	Quantization	Scanning	Frame (Field) Rates	Compliant Standard
YCbCr 4:2:2	10 bits	1080p	60/59.94/50	SMPTE ST 424 SMPTE ST 425
	12 bits	1080p	30/29.97/25/24/23.98	
		1080PsF	30/29.97/25/24/23.98	
		1080i	60/59.94/50	
YCbCr 4:4:4	10 bits	1080p	30/29.97/25/24/23.98	
		1080PsF	30/29.97/25/24/23.98	
		1080i	60/59.94/50	
		720p	60/59.94/50/30/29.97/25/24/23.98	
	12 bits	1080p	30/29.97/25/24/23.98	
		1080PsF	30/29.97/25/24/23.98	
		1080i	60/59.94/50	
		RGB 4:4:4	10 bits	1080p
1080PsF	30/29.97/25/24/23.98			
1080i	60/59.94/50			
720p	60/59.94/50/30/29.97/25/24/23.98			
12 bits	1080p		30/29.97/25/24/23.98	
	1080PsF		30/29.97/25/24/23.98	
	1080i		60/59.94/50	
	1080p		24/23.98	(2048×1080)
1080PsF	24/23.98			

\* 720p/30, 720p/29.97, 720p/25, and 720p/24 signals can not be used in external sync mode. In addition, 2H display on the video signal waveform display is not possible for 1080p/60, 1080p/59.94, and 1080p/50 signals.

## 2. SPECIFICATIONS

Table 2-5 3G-SDI level B video signal formats and standards

Color System	Quantization	Scanning	Frame (Field) Rates	Compliant Standard
Y <sub>CbCr</sub> 4:2:2	10 bits	1080p	60/59.94/50	SMPTE ST 424
	12 bits	1080p	30/29.97/25/24/23.98	SMPTE ST 425
		1080PsF	30/29.97/25/24/23.98	
		1080i	60/59.94/50	
Y <sub>CbCr</sub> 4:4:4	10 bits	1080p	30/29.97/25/24/23.98	
		1080PsF	30/29.97/25/24/23.98	
		1080i	60/59.94/50	
	12 bits	1080p	30/29.97/25/24/23.98	
		1080PsF	30/29.97/25/24/23.98	
		1080i	60/59.94/50	
RGB 4:4:4	10 bits	1080p	30/29.97/25/24/23.98	
		1080PsF	30/29.97/25/24/23.98	
		1080i	60/59.94/50	
	12 bits	1080p	30/29.97/25/24/23.98	
		1080PsF	30/29.97/25/24/23.98	
		1080i	60/59.94/50	
		1080p	24/23.98	
1080PsF	24/23.98			

\* 2H display on the video signal waveform display is not possible for 1080p/60, 1080p/59.94, and 1080p/50 signals.

Table 2-6 3G-SDI level B (2map) video signal formats and standards

Color System	Quantization	Scanning	Frame (Field) Rates	Compliant Standard
Y <sub>CbCr</sub> 4:2:2	10 bits	1080i	60/59.94/50	SMPTE ST 424
		1080p	30/29.97/25/24/23.98	SMPTE ST 425
		1080PsF	30/29.97/25/24/23.98	
		720p	60/59.94/50/30/29.97/25/24/23.98	

\* 720p/30, 720p/29.97, 720p/25, 720p/24, and 720p/23.98 signals can not be used in external sync mode.

Ancillary Data Standard	SMPTE ST 291
Format Setting	Automatic and manual
Automatic	
3G-SDI and HD Dual Link	The LV 5770A detects the format information within the payload ID (SMPTE ST 352) and automatically sets the format.
HD-SDI and SD-SDI	The LV 5770A determines the format from the input signal's synchronization information and automatically sets the format.
Manual	The video signal format is set manually.

## 2. SPECIFICATIONS

### 2.3.2 Embedded Audio Playback Format (LV 5770SER41/LV 5770SER43 and LV 5770SER08/LV 5770SER09A)

#### Compliant Standards

3G-SDI, HD-SDI, and HD Dual Link	SMPTE ST 299
SD-SDI	SMPTE ST 272
Format	LPCM, Dolby-E (option), Dolby Digital (option)
Quantization	24 bits
Clock Generation	Generated from the video clock
Synchronization	All audio channels must be synchronized with the video clock. In simul mode, channels A and B must be synchronized.
Channel Separation	2 groups—8 channels (channels A and B can be mixed), 4 groups—16 channels (LV 5770SER43)

### 2.3.3 Analog Composite Signal Formats and Standards (LV 5770SER03A)

Input Signal	NTSC/PAL composite video signal HD tri-level sync signal
Compliant Standards	
Composite Signal	SMPTE ST 170, ITU-R BT.470
HD Tri-level Sync Signal	SMPTE ST 274
HD Tri-Level Sync Signal Format (*1)	1080i/60, 1080i/59.94, 1080i/50, 1080p/30, 1080p/29.97, 1080p/25, 1080p/24, 1080p/23.98, 1080PsF/30, 1080PsF/29.97, 1080PsF/25, 1080PsF/24, 1080PsF/23.98

\*1 If a 1035i (not supported) signal is applied, it is detected as a 1080i signal.  
If a 1080PsF/30, 1080PsF/29.97, or 1080PsF/25 signal is applied, it is detected as a 1080i/60, 1080i/59.94, or 1080i/50 signal (respectively).

### 2.3.4 SDI I/O Connectors (LV 5770SER08 and LV 5770SER09A)

#### SDI Input

Input Connectors	Two BNC connectors
3G-SDI, HD-SDI, and SD-SDI	2 inputs (channels A and B)
HD Dual Link	1 input (link channel A or B)
Input Impedance	75 Ω
Input Return Loss	
5 MHz to 1.485 GHz	15 dB or more
1.485 to 2.97 GHz	10 dB or more
Maximum Input Voltage	
LV 5770SER08 and LV 5770SER09	±2 V (DC + peak AC)
LV 5770SER09A	0 to +12V (DC), ±1V (AC)

## 2. SPECIFICATIONS

### SDI Output

Output Connectors	Two BNC connectors
Output Signal	Serial reclocked input SDI signal
3G-SDI, HD-SDI, and SD-SDI	1 output (switchable between channels A and B)
	1 output (fixed to channel B)
HD Dual Link	1 output (link channel A or B)
Output Impedance	75 $\Omega$
Output Voltage	800 mVp-p $\pm$ 10 % (into 75 $\Omega$ )
Output Return Loss	
5 MHz to 1.485 GHz	15 dB or more
1.485 to 2.97 GHz	10 dB or more

### 2.3.5 Analog Video I/O Connectors (LV 5770SER03A)

#### Analog Composite Input Connectors

Input Connectors	Two BNC connectors (switchable between channels A and B)
Input Impedance	75 $\Omega$
Input Return Loss	
6 MHz or less	30 dB or more
6 to 20 MHz	18 dB or more
Maximum Input Voltage	$\pm$ 5 V (DC + peak AC)

#### Analog Composite Output Connector

Output Connector	One BNC connector
Output Signal	Generates the selected analog composite input channel (A or B) (active output)
Output Impedance	75 $\Omega$
Output Voltage	1 Vp-p $\pm$ 5 % (into 75 $\Omega$ )
Frequency Response	
25 Hz to 5 MHz	$\pm$ 5 %
5 to 15 MHz	-10 to +5 %
15 to 20 MHz	$\pm$ 10%

### 2.3.6 External Sync Signal Input Connectors (LV 5770SER03A, LV 5770SER08, and LV 5770SER09A)

Input Connectors	1 pair of BNC connectors
Input Signal	Tri-level sync or NTSC/PAL black burst signal
Input Impedance	15 k $\Omega$ passive loop-through
Input Return Loss	30 dB or more (50 kHz to 30 MHz into 75 $\Omega$ )
Maximum Input Voltage	$\pm$ 5 V (DC + peak AC)

\* If the video signal waveform is displayed using an external sync signal as the reference, inserting or removing an SDI signal or restarting the device may cause the waveform phase to be off by one clock.

- \* The following formats can not be used in external sync mode.
  - HD dual link's 1080p/60, 1080p/59.94, and 1080p/50
  - 3G's 720p/30, 720p/29.97, 720p/25, 720p/24, and 720p/23.98

## 2. SPECIFICATIONS

### 2.3.7 Audio I/O Connectors (LV 5770SER41, LV 5770SER42, and LV 5770SER43)

#### I/O connectors of the digital audio (LV 5770SER41 and LV 5770SER43)

I/O Connector	BNC connector
Group A	4 connectors, 8 channels
Group B	4 connectors, 8 channels
I/O Switching	Switching between the connections (4 connectors, 8 channels)
I/O Impedance	75 $\Omega$
Maximum Input Voltage	$\pm 5$ V (DC + peak AC)
Output Voltage	1.0 Vp-p $\pm 10$ % (into 75 $\Omega$ )
Compliant Standard	AES-3id
Supported Format	L-PCM, Dolby-E (option), Dolby Digital (option)
Sampling Frequency	48 kHz
Output Signal	Channels 1 to 16 for SDI embedded audio 8 channels of audio (1 to 8 or 9 to 16) are displayed on the screen. (Dolby signals are decoded and generated.)

#### I/O connector of the analog audio (LV 5770SER42)

I/O Connector	37-pin D-sub (female)
Locking screws	Inch screws (No.4-40UNC)
Input Signal Format	DC-coupled balanced input
Number of Input Channels	8 channels
Input Impedance	20 k $\Omega$ or more
Maximum Input Voltage	24 dBu
Output Signal Format	DC-coupled balanced output
Number of Output Channels	8 channels
Output Impedance	50 $\Omega$ (nominal)
Output Signal	Eight channels of audio signals displayed on the screen (Dolby signals are decoded and generated as analog signals.)

#### Maximum Output Level

With a Load of 100 k $\Omega$ or More	24 dBu
With a Load of 600 $\Omega$ or More	4 dBu

#### Headphone Output (LV 5770SER41 and LV 5770SER43)

Output Connector	One stereo jack
Output Signal	2 channels from the audio signals that are being displayed on the screen (downmixed LT and RT are also possible)
Sampling Frequency	Only 48 kHz
Volume Adjustment	Adjusted from the menu
Power Output	Maximum 100 mW (into 8 $\Omega$ load resistance)

\* The LV 5770SER08 or LV 5770SER09A is required to generate embedded audio signals.

## 2. SPECIFICATIONS

### 2.3.8 Video Output Connectors

#### DVI-D Output Connector

Output Connector	One DVI-D connector
Output Signal	Digital signal of the LCD display
Resolution	XGA (1024 × 768)
Aspect Ratio	4:3
Signal Format	Single link TMDS
DDC	Not supported
HOT PLUG Detection	Not supported

#### Picture Monitor Output Connector (LV 5770SER08 and LV 5770SER09A)(\*1)

Output Connector	1
Output Signal	Monitor output of the selected SDI input signal (channel A or B)
Signal Format	Single link TMDS
Color Space Conversion	YCbCr 4:2:2, YCbCr 4:4:4, RGB 4:4:4 (convertible between color spaces)
Quantization Conversion	8 bits, 10 bits, 12 bits
Audio(*2)	SDI embedded audio channels 1 to 8 embedded in the output signal (LPCM only)

\*1 The following signals are not supported.

720p/24, 23.98

1080PsF/30, 29.97, 25, 24, 23.98

1080p/24, 23.98 (2048 × 1080)

1080PsF/24, 23.98 (2048 × 1080)

\*2 The audio channel mapping is fixed.

### 2.3.9 Control Connectors

#### USB Port

Specification	USB 2.0
Supported Media	USB memory device
Function	Used to save captured data, event logs, preset data, data dumps, and loudness logs.

#### Ethernet Port (\*1)

Compliant Standard	IEEE802.3
Supported Protocol	TELNET, FTP, SNMP, HTTP, SNTP
I/O Connectors	RJ-45
Function	Remote control from an external PC or the LV 7770-01
Type	10Base-T, 100Base-TX

#### Remote Control Connector

Function	Used to load preset settings, switch input channels, transmit the alarm signal, and start, stop, and clear the loudness measurement.
Control Signal	LV-TTL level (low active)
Input Voltage Range	0 to 5 VDC
Control Connector	15-pin D-sub (female)



## 2. SPECIFICATIONS

Locking screws                      Inch screws (No.4-40UNC)

\*1    You cannot use TELNET and the LV 7770-01 at the same time.

### 2.3.10    LCD

LCD Type	6.5-inch color TFT
Display Format	XGA. The effective resolution is 1024 × 768.
Backlight Brightness Switching	16 levels
Auto Shutoff	LCD can be automatically turned off after a set period of time.

### 2.3.11    Screen Capture

Function	Captures the display
Display	Displays only the captured image or overlays the captured image over the input signal
Media	Internal memory (RAM) and USB memory You can only record one screen capture to the internal memory.
Data Output	Screen captures can be saved as bitmap files to USB memory, or they can be saved in a file format that the LV 5770A can load.
Data Input	Data saved to USB memory can be loaded and displayed on the LV 5770A.

### 2.3.12    Frame Capture (LV 5770SER08 and LV 5770SER09A)

Function	Captures frame data
Display	Displays the captured frame data or superimposes the captured frame data over the input signal
Media	Internal memory (RAM) and USB memory You can only record one frame of data to the internal memory
Data Output	Frame captures can be saved to USB memory as .dpx files, .tif files, or in a file format that the instrument can load
Data Input	Data saved to USB memory can be loaded and displayed on the instrument (*1)
Capture Timing	Manual and automatic (error capture)
Error Capturing	Automatically captures frame data when an error occurs

\*1    An input signal in the same format as the frame data is required.

## 2. SPECIFICATIONS

### 2.3.13 Presets

Presets(*1)	Saves the panel settings
Number of Presets	60
Preset Loading Method	Front panel, remote control connector (*2), or ethernet
Copying	All preset data can be copied from the LV 5770A to a USB memory device or from a USB memory device to the LV 5770A.

\*1 Settings related to whether the instrument is on or off, the ethernet connector, the remote control connector, the date, and the time are not saved.

\*2 The number of presets loaded from the remote control connector can be 8 (6 when loudness measurement is being controlled) or 60.

### 2.3.14 Main Display Features

Input	SDI (LV 5770SER08 and LV 5770SER09A) and Composite (LV 5770SER03A)
Input Mode	Single input mode, simul mode, and 3G-SDI 2mapping (Only single input mode is available for HD dual link signals and composite input signals.)
Single Input Mode	Displays a single input signal
Simul Mode	Displays up to two input signals simultaneously
3G-SDI 2mapping Mode	Splits a 3G-SDI signal into two HD-SDI signals and displays them simultaneously
Simul Mode and 3G-SDI 2 Mapping Mode Display Format	Mixed, tiled, aligned (differs depending on the displayed contents)
Display Sizes	1-screen display, 2-screen multi display, and 4-screen multi display
1-Screen Display	Displays a single, large screen (the thumbnail display can be turned on and off)
2-Screen Multi Display	Splits the display into two screens (left and right)
4-Screen Multi Display	Splits the display into four screens

### 2.3.15 SDI Signal Video Waveform Display (LV 5770SER08 and LV 5770SER09A)

Simul Mode Display Format	Mix, aligned
Waveform Operations	
Display Mode	
Overlay	Overlays component signals
Parade	Displays component signals side by side
Blanking Interval	H and V blanking periods can be masked.
RGB Conversion	Converts a Y,C <sub>B</sub> ,C <sub>R</sub> signal into an RGB signal and displays the result
Channel Mapping	GBR or RGB order
Pseudo-Composite Display	Artificially converts component signals into composite signals and displays the result
Line Select	Selected line display
Sweep Modes	H, V

## 2. SPECIFICATIONS

Display Colors	Seven colors to choose from; a different color for each input channel
Vertical Axis	
Gain	×1, ×5
Variable Gain	×0.2 to ×2
Amplitude Accuracy	
×1	±0.5 %
×5	±0.2 %
3G-SDI, HD Dual Link (1080p/60, 1080p/59.94, 1080p/50)	
Y Signal	±0.5 % for 1 to 60 MHz
C <sub>B</sub> C <sub>R</sub> Signal	±0.5 % for 0.5 to 30 MHz
Low-Pass Attenuation	20 dB or more (at 40 MHz)
3G-SDI, HD-SDI, HD Dual Link (excluding 1080p/60, 1080p/59.94, 1080p/50)	
Y Signal	±0.5 % for 1 to 30 MHz
C <sub>B</sub> C <sub>R</sub> Signal	±0.5 % for 0.5 to 15 MHz
Low-Pass Attenuation	20 dB or more (at 20 MHz)
SD-SDI	
Y Signal	±0.5 % for 1 to 5.75 MHz
C <sub>B</sub> C <sub>R</sub> Signal	±0.5 % for 0.5 to 2.75 MHz
Low-Pass Attenuation	20 dB or more (at 3.8 MHz)
Horizontal Axis	
Line Display	×1, ×10, ×20, ACTIVE, BLANK
Field Display	×1, ×20, ×40
Cursor Measurement	
Composition	
Horizontal Cursors	2 (REF and DELTA)
Vertical Cursors	2 (REF and DELTA)
Amplitude Measurement	mV, %, R%, DEC, HEX
Time Measurement	Second display
Frequency Display	Computes and displays the frequency with the length of one period set to the time between two cursors
Scale	
Types	% scale, V scale, decimal scale, hexadecimal scale
Display Color	Seven colors to choose from
Thumbnail Display	Picture, audio level meter, histogram

## 2. SPECIFICATIONS

### 2.3.16 Analog Composite Signal Video Waveform Display (LV 5770SER03A)

#### Waveform Operations

Line Select	Selected line display
Sweep Mode	H, V
Display Color	Seven colors to choose from

#### Vertical Axis

##### Scale

Composite Signal	
NTSC	-40 to 100 IRE
PAL	-0.3 to 0.7 V
HD Tri-level Sync Signal	-0.3 to 0.7 V, -43 to 100 % (the unit is switchable between V and %)

Gain  $\times 1, \times 5$

Variable Gain  $\times 0.2$  to  $\times 2$

Amplitude Accuracy  $\pm 1$  %

##### Frequency Response

Composite Signal	
25 Hz to 5 MHz	$\pm 2$ %
5 to 5.6 MHz	-7 to +3 %

##### HD Tri-level Sync Signal

25 Hz to 15 MHz	$\pm 5$ %
15 to 20 MHz	$\pm 10$ %

Step Response (for 1 V full scale, flat, 2T pulse, and 2T bar)(when a composite video signal is applied)

Overshoot	$\pm 2$ %
Preshoot	$\pm 1$ %
Ringing	$\pm 2$ %
Pulse/Bar Ratio	$\pm 1$ %
Vertical Tilt	$\pm 1$ %
Filter	Luminance filter
DC Restorer	Clamp to the back porch

#### Horizontal Axis

Operation Mode Displays a single waveform

##### Display Format

Line Display	1H, 2H
Line Magnification	$\times 1, \times 10, \times 20$
Field Display	1V, 2V
Field Magnification	$\times 1, \times 20, \times 40$

Time Base Accuracy  $\pm 1$  %

#### Cursor Measurement

Horizontal Cursors 2 (REF and DELTA)

    Time Measurement Second display

    Frequency Display Computes and displays the frequency with the length of one period set to the time between two cursors

Vertical Cursors 2 (REF and DELTA)

    Amplitude Measurement mV, %, R%

Thumbnail Display Picture, audio level meter, histogram

## 2. SPECIFICATIONS

### 2.3.17 SDI Signal Vector Waveform Display (LV 5770SER08 and LV 5770SER09A)

Simul Mode Display Format	Mixed, tiled
Display Colors	Seven colors to choose from; a different color for each input channel
Blanking Interval(*1)	Masked
Pseudo-Composite Display	Artificially converts component signals into composite signals and displays the result
Line Select	Selected line display
Gain	×1, ×5, IQ-MAG
Variable Gain	×0.2 to ×2
Amplitude Accuracy	±0.5 %
Scale	
Type	ITU-R BT.601, ITU-R BT.709, AUTO
Color Bar Saturation	75 %, 100 %
IQ Axis	Show, hide
Display Colors	Seven colors to choose from
Thumbnail Display	Picture, audio level meter, histogram

\*1 On the multi-screen display, this depends on the video signal waveform display's blanking display settings.

### 2.3.18 Analog Composite Signal Vector Waveform Display (LV 5770SER03A)

Line Select	Selected line display
Gain	×1, ×5, IQ-MAG
Variable Gain	×0.2 to ×2
Amplitude Accuracy	±3 %
Phase Accuracy	±2°
Phase Adjustment Range Display	360°
Scale	
Color Bar Saturation	75 %, 100 %
IQ Axis	Show, hide
Display Colors	Seven colors to choose from
Setup (NTSC)	0 % or 7.5 %
NTSC Display (PAL)	NTSC or PAL display
SCH Display	Displays the SCH value numerically
Thumbnail Display	Picture, audio level meter, histogram

\* The vectorscope display is only available when a composite video signal is applied.

## 2. SPECIFICATIONS

### 2.3.19 SDI Signal 5-Bar Display (LV 5770SER08 and LV 5770SER09A)

Simul Mode Display Format	Tiled only
Function	Converts an SDI signal into Y, R, G, B, and composite values and then displays the five peak levels
Channel Assignment	RGB, GBR
Scale	mV, %
Error Level	Based on the gamut error, composite gamut error, and luminance error thresholds
Line Select	Selected line display
Low-Pass Filter	The same as gamut errors Removes transient errors
Thumbnail Display	Picture, audio level meter, histogram

### 2.3.20 SDI Signal Picture Display (LV 5770SER08 and LV 5770SER09A)

Simul Mode Display Format	Mixed, tiled
Quantization	8 bits
Display Sizes	Fit, full frame, real, ×2
Frame Rate	The frame rate is converted and displayed using the internal sync signal.
Aspect Marker	
HD-SDI	4:3, 13:9, 14:9, 2.39:1, AFD
SD-SDI	13:9, 14:9, 16:9, AFD
Aspect Marker Format	Line, shadow (99 levels), black
Safety Marker Size	ARIB TR-B4, SMPTE RP-218, user-defined
Line Select	Marks the selected line
AFD Display	Displays abbreviations for SMPTE 2016-1-2007 standard AFD codes
Gamut Error Display	The positions of gamut errors are displayed on the picture (this is the logical sum of gamut, composite gamut, and luminance errors)
Superimpose(*1)	Displays English closed captions over the picture
Compliant Standards	
EIA-708	SMPTE ST 334
EIA/CEA-608-B (EIA-708-B)	SMPTE ST 334
EIA/CEA-608-B (EIA/CEA-608-B)	SMPTE ST 334
VBI (EIA/CEA-608-B Line21)	CIA/EIA-608-B
CINELITE Display	Displays the luminance information on the picture screen
Features	f Stop display, percentage display, and level display
f Stop Display	Displays the f value relative to the reference point
f Stop Gamma Correction	
Reference Gamma	0.45 (ITU-R BT709)
User-Defined Correction Tables	3
External Correction Tables	5 (read from USB memory)

## 2. SPECIFICATIONS

Percentage Display	Displays luminance or RGB components as percentages
Level Display	Displays RGB components with 256 levels (8 bits)
Measured points	3
Measurement sizes	1 pixel, 3 × 3 pixels, or 9 × 9 pixels
CINELITE Advanced Display	
Features	Synchronized marker display, vector marker display
Synchronized Marker Display	Synchronizes the markers on the vector display or waveform display to the measurement points of the CINELITE display's f Stop display or % display
Vector Marker Display	Displays numerically the specified position on the vector display
Number of Markers	
Synchronized Marker	Up to 4
Vector Marker	1
Vector Numeric Display	Displays numerically the active marker position
Cb	Displays the C <sub>B</sub> position as a percentage
Cr	Displays the C <sub>R</sub> position as a percentage
deg	Displays the hue in degrees
d	Displays the distance from the center as a percentage
CINEZONE Display	
Description	Displays the luminance levels in the picture using different colors
Color	
Gradation	1024 colors
Step	12 colors
Search	Monochrome + 3 colors
Gradation and Step Displays	
Upper Limit Setting	-6.3 to 109.4 % (Values above the upper limit are displayed using white)
Lower Limit Setting	-7.3 to 108.4 % (Values below the lower limit are displayed using black)
Search Display	
Description	Displays a specified luminance level ±0.5 % using green on an otherwise monochrome picture display
Luminance Level Setting	-7.3 to 109.4 %
Upper Limit Setting	-6.3 to 109.4 % (Values above the upper limit are displayed using red)
Lower Limit Setting	-7.3 to 108.4 % (Values below the lower limit are displayed using blue)
Thumbnail Display	Video signal waveform, audio level meter, histogram

\*1 This is not supported when the input signal is 3G-SDI or HD dual link.

## 2. SPECIFICATIONS

### 2.3.21 Analog Composite Signal Picture Display (LV 5770SER03A)

Quantization	8 bits
Display Sizes	Fit, full frame, real, ×2
Frame Rate	The frame rate is converted and displayed using the internal sync signal
Aspect Marker Display	16:9, 14:9, 13:9
Aspect Marker Format	Line, shadow (99 levels), black
Safety Marker Size	SMPTE RP-218, user-defined
Line Select	Marks the selected line
Thumbnail Display	Video signal waveform, audio level meter, histogram

\* The picture display is only available when a composite video signal is applied.

### 2.3.22 SDI Signal 3D-Assist Display (LV 5770SER08 and LV 5770SER09A)

#### Input Connectors

Video Signal for the Left Eye Channel A or stream 1 of 3G-B (2map)

Video Signal for the Right Eye Channel B or stream 2 of 3G-B (2map)

#### Picture Display

Anaglyph Display (Color) Green and blue are masked from the video signal for the left eye, and red is masked from the video signal for the right eye. These signals are then combined

#### Anaglyph Display (Monochrome)

Green and blue are masked from the monochrome video signal for the left eye, and red is masked from the monochrome video signal for the right eye. These signals are then combined

#### Convergence Display

A 50 % offset is added to the difference between the monochrome video signal for the left eye and the monochrome video signal for the right eye

#### Overlay Display

The levels of the video signal for the left eye and the video signal for the right eye are halved. These signals are then combined

#### Checker Display

Displays the video signal for the left eye and the video signal for the right eye in a checkerboard pattern

#### Boundary Lines

Can be moved up, down, left, and right

#### Wipe Display

The video signal for the left eye and the video signal for the right eye are divided by boundary lines and displayed

#### Boundary Lines

The boundary lines can be moved up and down and left and right separately

Show, hide

#### Left-Right Boundary Line

The part to the left of the boundary line is the video signal for the left eye. The part to the right of the boundary line is the video signal for the right eye

#### Top-Bottom Boundary Line

The part above the boundary line is the video signal for the left eye. The part below the boundary line is the video signal for the right eye

#### Flicker Display

Displays the video signal for the left eye and the video



## 2. SPECIFICATIONS

	signal for the right eye on a time sharing display
Inverted Display	
Horizontal Inversion	Inverts the picture and video signal waveform (*1)
Vertical Inversion	Inverts the picture
Inverted Channel	Inverts video signal for the left eye and video signal for the right eye separately
Grid Display	
Description	Displays grid lines on the picture
Grid Type	Disparity, horizontal, both
Disparity Grid Width	6 to 192 pix (0.3 to 10.0 %) (*2)
Horizontal Grid Width	6 to 108 line (0.6 to 10.0 %) (*2)
Grid Movement	The disparity and horizontal grid lines can be moved separately
Video Signal Waveform Display	
Display Format	Side by side, overlaid
Wipe Feature	L/R wipe
Disparity Measurement Feature	
Description	Position the cursor at a point in the picture to measure the disparity and luminance level at that point
Alarm	If the upper limit is exceeded, "NG" (no good) is displayed
Measurable Items	Screen disparity (dots, cm, %), perceived depth (m), angle of vergence (°)

\*1 Horizontal inversion of the video signal waveform occurs only during the video period.

\*2 The pixel and line ranges vary depending on the input signal. The values shown here are for a 1080i/59.94 input signal.

### 2.3.23 Digital Audio Display (LV 5770SER41 and LV 5770SER43)

Simul Mode Display Format	Tiled only (the audio of channels A and B is synchronized)
Input Signal	SDI embedded audio input (requires the LV 5770SER08 or LV 5770SER09A), digital audio input
Displayed Channels	
LV 5770SER41	Up to 8 channels
LV 5770SER43	Up to 16 channels
Channel Selection	
SDI Embedded Audio	Any two groups from groups 1, 2, 3, and 4, all groups 1, 2, 3, and 4 (*1)
Digital Audio	Group A, group B, group A + group B (*1) (set to the input connectors)
Display Type	Level meter, Lissajous and correlation meter, surround, status, loudness
Level Meter Display	
Displayed Channels	2, 8, 16 (*1)
Dynamic Range	-60 dBFS, -90 dBFS, reference level $\pm$ 3dB (*1)
Meter Response Model	TRUE PEAK, PPM type I, PPM type II, VU
Peak Hold Response Model	TRUE PEAK, PPM type I, PPM type II

## 2. SPECIFICATIONS

Peak Hold Time	0.0 to 5.0 s (in 0.5 s steps), HOLD
Level Setting	-40.0 to 0.0 dBFS (standard level, warning level, over level)
Non-PCM Detection (Option)	Displays non-PCM audio channels with cyan flags (*1)
Lissajous Display	
Displayed Channels	2 (single), 8 (multi), 16 (multi)(*1)
Display Mode	X-Y, MATRIX
Correlation Meter	Displays the correlation between two channels as a value from -1 to 1
Indicator Display (Option)	Displays Dolby-E frame locations with indicators
Surround Display	
Function	Displays a graphical representation of a sound field
Surround Format	5.1
Mapping Channels	L, R, C, LFE, Ls (S), Rs, LL, RR
Center Channel Format	Normal, phantom center
Gain	×1, AUTO
Correlation Display	Detects the case of the channel being 180 ° out of phase with its adjacent channels
Status Display	
Level	Audio levels are displayed using numbers (dBFS).
Error Detection	Counts the number of errors that occur for each channel
Level Over	Counts the number of times that the level of the input signal exceeds the set value
Detection Setting	-40.0 to 0.0 dBFS
Clipping	Counts the number of times that a received signal exceeds the maximum signal value for the specified number of consecutive samples
Detection Setting	1 to 100 samples
Mute	Counts the number of times that the length of a received mute signal exceeds the specified period
Detection Setting	1 to 5000 ms
Parity Error	Counts the number of times that the input signal's parity bit and the parity bit recalculated by the LV 5770A differ
Validity Error	Counts the number of times that the input signal's validity bit is 1
CRC Error	Counts the number of times that the CRC of the channel status bits and the calculated CRC are different
Code Violation	Counts the number of times that the state of the input signal's biphase modulation is abnormal
Elapsed Time	Displays the amount of time that has elapsed since the instrument was reset
Channel Status Bits	Dump display, text display
User Data Bits	Dump display
Dolby-E Metadata	Text display (option)
Dolby Digital Metadata	Text display (option)

## 2. SPECIFICATIONS

Loudness Display	
Function	Loudness chart display, numeric display, log, level meter display (*1), peak value display (*1)
Compliant Standard	ITU-R BS.1770, ARIB TR-B32, EBU R128, ATSC A/85
Measurement Channel	Simultaneous measurement of two audio sources (*1)
Mode (Main)	Monaural, stereo, 5.1, user specified channel
Mode (Sub)(*1)	Off, monaural, stereo
Channel Selection	User-defined assignment of eight channels
LFE Gain	0 to 10 times
Measurement Trigger	Manual (panel), remote, timecode (requires the LV 5770SER08 or LV 5770SER09A), mute (*1)
Measurement Mode	BS1770-2, ARIB, EBU, ATSC
Target Level	
BS1770-2	-24.0 LKFS
ARIB	-24.0 LKFS (±1 LK)
EBU	-23.0 LUFS (±1 LU)
ATSC	-24.0 LKFS (±2 LK)
Average Time	
Momentary Loudness	200 to 10000 ms
Short-term Loudness	200 to 10000 ms
Chart Display	
1 During Audio Measurement	Graph display of integrated loudness and momentary or short-term loudness
2 During Audio Measurement (*1)	Graph display of integrated, momentary, or short-term loudness
Measurement Time	
Standard Model	2min, 10min, 30min, 1hour, 2hour
Option	6hour, 12hour, 24hour, 32hour
MAG	Zoomed display of the target level from -18 to +9 (LK/LU)
Numeric Display	Absolute value and relative value displays of integrated loudness and momentary or short-term loudness
Integrated Loudness	Displayed in red when the target level range is exceeded
Momentary, Short-term Loudness	Displayed in red when the target level is exceeded
Log	
Log Time	Up to 2 hours (up to 32 hours with an option)
File	
Log	Saved in CSV format
Summary	Saves settings in text format
Level Meter Display (*1)	Displays level meters for eight channels
Peak Value Display (*1)	Displays peak values of a measurement channel numerically

\*1 A feature available only on the LV 5770SER43.

## 2. SPECIFICATIONS

### 2.3.24 Analog Audio Display (LV 5770SER42)

Input Signal	Analog audio input
Displayed Channels	Up to 8 channels
Display Type	Level meter, Lissajous, surround, status, loudness
Level Meter Display	The specifications other than those listed here are the same as the digital audio specifications
Scale Reference Level	Scales 4 dBu to -20 dBFS
Level Accuracy	±0.3 dB (-50 to 0 dBFS, 1 kHz, signal source impedance of 40 Ω or less)
Frequency Response	
30Hz to 20kHz	±0.4 dB (4 dBu, 1 kHz reference, TRUE PEAK response)
20Hz to 20kHz	+0.4 dB, -0.6 dB (4 dBu, 1 kHz reference, TRUE PEAK response)
Lissajous Display	The same as digital audio
Surround Display	The same as digital audio
Status Display	Displays only level values and level-over indications
Loudness Display	The same as digital audio

\* The LV 5770SER41 or LV 5770SER43 is required for the LV 5770SER42 to operate.

### 2.3.25 SDI Signal Status Display (LV 5770SER08 and LV 5770SER09A)

Signal Detection	Detects the presence of an SDI signal
Format Display	Displays the video signal format
Error Count	Up to 999,999 errors for each error type
Count Period	1 second, 1 field (frame)
Equivalent Cable Length Measurement (LV 5770SER09A)	Displays SDI signal attenuation in terms of cable length
Supported Cables	
3G-SDI, HD-SDI	LS-5CFB, 1694A
SD-SDI	L-5C2V, 8281
Display Range	
3G-SDI	< 10 m, 10 to 105 m, > 105 m
HD-SDI	< 5 m, 5 to 130 m, > 130 m
SD-SDI	< 50 m, 50 to 300 m, > 300 m
Resolution	5 m
Accuracy	±20 m
Embedded Audio Channel Display(*1)	Displays the embedded audio channel numbers
SDI Signal Error Detection	
CRC Error	Detects 3G-SDI, HD-SDI, and HD dual link signal transmission errors
EDH Error	Detects SD-SDI signal transmission errors
TRS Position Error	Detects TRS embedding position errors
TRS Code Error	Detects TRS protection bit errors
Line Number Error	Detects errors with the line numbers embedded in 3G-SDI, HD-SDI, and HD dual link signals
Illegal Code Error	Detects data within the range of 000h to 003h and 3FCh

## 2. SPECIFICATIONS

	to 3FFh in locations other than TRS and ADF
Dual Link Phase Difference Error	Detects errors when the phase difference between links A and B is 100 clocks or more
Cable Length Measurement Error (LV 5770SER09A)	Displays an error if the specified cable length is exceeded
3G-SDI	10 to 105 m, 5 m steps
HD-SDI	5 to 130 m, 5 m steps
SD-SDI	50 to 300 m, 5 m steps
Ancillary Data Packet Error Detection	
Checksum Error	Detects ancillary data transmission errors
Parity Error	Detects ancillary data header parity errors
Embedded Audio Packet Error Detection(*1)	
BCH Error	Detects audio packet transmission errors
DBN Error	Detects audio packet continuity errors
Parity Error	Detects audio packet parity errors
Embedded Position Error	Detects the presence of audio in lines where it should not be embedded
Sample Counter Error	Detects asynchronous audio by measuring the number of audio samples
Image Quality Error Detection	
Gamut Error	Detects gamut errors
Detection Range	
Upper Limit	90.8 to 109.4 %
Lower Limit	-7.2 to 6.1 %
Low-Pass Filter	
HD-SDI	Approx. 1 MHz LPF (IEEE STD 205), approx. 2.8 MHz LPF, OFF
SD-SDI	Approx. 1 MHz LPF (EBU R103-2000), OFF
Area Specification	0.0 to 5.0 %
Time Specification	1 to 60 frames
Composite Gamut Error	Detects level errors that occur when component signals are converted to composite signals
Detection Range	
Upper Limit	90.0 to 135.0 %
Lower Limit	-40.0 to 20.0 %
Low-Pass Filter	The same as the gamut error
Area Specification	0.0 to 5.0 %
Time Specification	1 to 60 frames
Freeze Error(*2)	Detects freezing of video within the specified time range
Detection Method	Video interval checksum
Time Specification	2 to 300 frames

## 2. SPECIFICATIONS

Black Error(*2)	Detects video blackouts
Black Level Specification	0 to 100 %
Area Specification	1 to 100 %
Time Specification	1 to 300 frames
Level Error(*2)	Detects YC <sub>B</sub> C <sub>R</sub> level errors
Upper Y Limit	-51 to 766 mV
Lower Y Limit	-51 to 766 mV
Upper C <sub>B</sub> C <sub>R</sub> Limit	-400 to 399 mV
Lower C <sub>B</sub> C <sub>R</sub> Limit	-400 to 399 mV
Low-Pass Filter	The same as the gamut error

\*1 If the input signal is 3G-SDI level B, only stream 1 is supported. If the input signal is HD dual link, only link A is supported.

\*2 This is not supported when the input signal is 3G-SDI or HD dual link.

### 2.3.26 Analog Composite Signal Status Display (LV 5770SER03A)

#### Phase Difference Display

Function	Displays the phase difference between a reference signal and an input signal both numerically and graphically
Reference Signal	NTSC/PAL black burst signal HD tri-level sync signal (The same format as the input signal)
Display Range	
Vertical	1 frame
Horizontal	±1 line

### 2.3.27 Event Log (LV 5770SER08, LV 5770SER09A, LV 5770SER41, and LV 5770SER43)

Function	Records detected errors, events—such as the LV 5770A switching between input signals, and time stamps.
Recording Capacity	Up to 1000 events
Operation	Records all events from start to finish
Data Output	Data can be saved as text files to USB memory or over an Ethernet

## 2. SPECIFICATIONS

### 2.3.28 SDI Analysis Features (LV 5770SER08 and LV 5770SER09A)

#### Data Dump Display

##### HD-SDI and SD-SDI Display Format

Displays data separated by serial data sequence or by channel

##### 3G-SDI Display Format

Stream 1, stream 2, stream A and B simultaneously

##### HD Dual Link Display Format

Link A, link B, link A and B simultaneously

##### Line Select

Selected line display

##### Sample Select

Displays from the selected sample

##### Jump Feature

Jumps to an EAV or SAV

##### Data Output

Data can be saved as text files to USB memory or over an Ethernet

#### Phase Difference Display

##### Function

Displays the phase difference between a reference signal and an SDI video signal both numerically and graphically

##### Reference Signal

##### 3G-SDI, HD-SDI, SD-SDI

External sync signal, channel A of the SDI signal

##### HD Dual Link

External sync signal, link A

##### Display Range

##### Vertical

1 frame

##### Horizontal

±1 line

#### Audio Control Packet

##### Display Details

Displays audio control packet analysis

##### HD Dual Link

Link A

##### 3G-SDI Level B

Stream 1

##### 3G-SDI Level B (2map)

Stream 1, stream 2

##### Display Format

Text, hexadecimal, binary

##### Group Select

Select one group from four available groups.

#### EDH Display (Only for SD-SDI)

##### Compliant Standard

SMPTE RP-165

##### Display Details

Analyzes and displays EDH packets and displays received CRC errors

##### Display Format

Text, hexadecimal, binary

#### Payload ID Display

##### Compliant Standard

SMPTE ST 352

##### Display Details

Analyzes and displays payload information

##### Display Format

Text and binary

#### Closed Caption Analysis Display (\*1)

##### Compliant Standards

ARIB STD-B37, EIA-708-B, EIA/CEA-608-B

##### Display Details

Analyzes and displays the closed caption signal

##### Display Format

Text, hexadecimal, binary

## 2. SPECIFICATIONS

Inter-Stationary Control Signal (NET-Q) Display (*1)	
Compliant Standard	ARIB STD-B39
Display Details	Analyzes and displays inter-stationary control signals
Display Format	Text, hexadecimal, binary
Logging Feature	Q-signal logging
Format ID Display Feature	Analyzes and displays the format ID
Data Broadcast Trigger Signal (*1)	
Compliant Standard	ARIB STD-B35
Display Format	Text, hexadecimal, binary
V-ANC User Data Display (*1)	
Compliant Standard	ARIB TR-B23
Display Format	Hexadecimal, binary
User-Defined ANC Packet Display	
ANC Specification Method:	DID, SDID
Display Details	
HD-SDI, 3G-SDI	Y, C
HD Dual Link	Y, C
	Link A, link B
3G-SDI Level B, 3G-SDI Level B (2map)	Y, C
	Stream 1, stream 2
Display Format	Hexadecimal, binary
AFD Packet Display (*1)	
Compliant Standard	SMPTE 2016-1-2007
Display Format	Text, hexadecimal, binary

\*1 This is not supported when the input signal is 3G-SDI or HD dual link.

### 2.3.29 SDI Ancillary Data List Display (LV 5770SER08 and LV 5770SER09A)

List Display Details	Presence or absence of each ancillary data type, embedded line number, and number of packets per frame
Dump Display	The selected ancillary data is displayed in hexadecimal or binary.

\* This is not supported when the input signal is 3G-SDI or HD dual link.

### 2.3.30 Lip Sync Measurement (LV 5770SER41/LV 5770SER43 and LV 5770SER08/LV 5770SER09A)

Function	Measures the time difference between the SDI signal and digital audio signal and displays the results numerically and graphically
Reference Signal	A Leader TSG that supports lip syncing
Measurement Method	Measures the time difference when the luminance level of the video signal exceeds the specified value and when the audio level signal exceeds the specified value
Video Signal Luminance Level	25 to 100 %
Audio Signal Level	-30 to 0 dBFS



## 2. SPECIFICATIONS

Supported Audio Signals	Embedded audio signal, digital audio signal
Measurement Range (Bar Display)	$\pm 50$ ms, $\pm 100$ ms, $\pm 500$ ms, $\pm 1.0$ s, $\pm 2.5$ s
Measurement Range (Numeric Display)	$\pm 3999$ ms
Measurement Resolution	1 ms
Thumbnail Display	Picture, audio level meter

### 2.3.31 SDI Closed Caption Packet Display (LV 5770SER08 and LV 5770SER09A)

Table 2-7 SD-SDI video signal formats and standards

Feature	Compliant Standard	DID	SDID
EIA-708 CC decode feature	SMPTE ST 334	161h	101h
EIA/CEA-608-B CC decode feature (EIA-708-B)	SMPTE ST 334	161h	101h
EIA/CEA-608-B CC decode feature (EIA/CEA-608-B)	SMPTE ST 334	161h	102h
VBI (EIA/CEA-608-B line 21) CC decode feature	CIA/EIA-608-B		

CDP Packet Display Details	<p>CDP packet header information</p> <ul style="list-style-type: none"> <li>• Frame rate</li> <li>• Presence or absence of timecode packet</li> <li>• Presence or absence of closed caption packet and validity of this packet</li> <li>• Presence or absence of closed caption service packet and validity of this packet</li> <li>• Presence or absence of the FUTURE data packet</li> <li>• Timecode (when the timecode packet is present)</li> <li>• Closed caption data (when the closed caption packet is present and valid)</li> </ul> <p>Presence or absence of the CC1 to CC4 packets, the TEXT1 to TEXT4 packets, and the XDS packet</p>
XDS Packet Display Details	<p>Contents adviser information</p> <p>Copy management information</p>
ProgramDescription Packet Display Details	<p>Stuffing Descriptor</p> <p>AC3 Audio Descriptor</p> <p>Caption Service Descriptor</p> <p>Content Advisory Descriptor</p> <p>Extended Channel Name Descriptor</p> <p>Service Location Descriptor</p> <p>Time-Shifted Service Descriptor</p> <p>Component Name Descriptor</p> <p>DCC Departing Request Descriptor</p> <p>DCC Arriving Request Descriptor</p> <p>Redistribution Control Descriptor</p>

## 2. SPECIFICATIONS

### 2.3.32 Eye Pattern Display (LV 5770SER09A)

Display	Displays the input SDI waveform before equalizing
3G-SDI, HD-SDI, SD-SDI	Displays channel A or B, whichever is selected
HD Dual Link	Displays link A or B, whichever is selected
Method	Equivalent time sampling
Frequency Response	7 GHz -3dB (converted from the rise time)
Amplitude Accuracy	800 mV $\pm$ 5 % (for 800 mV input)
Time Axis	
2 UI Display	
3G-SDI	50 ps/div
HD-SDI	100 ps/div
SD-SDI	550 ps/div
4 UI Display	
3G-SDI	100 ps/div
HD-SDI	200 ps/div
SD-SDI	1100 ps/div
16 UI Display	
3G-SDI	400 ps/div
HD-SDI	800 ps/div
SD-SDI	4400 ps/div
Time Axis Accuracy	$\pm$ 3 %
Jitter Filter	
10 Hz	HPF 10 Hz
100 Hz	HPF 100 Hz
1 kHz	HPF 1 kHz
100 kHz	HPF 100 kHz
Timing	HPF 10 Hz
Alignment	
3G-SDI, HD-SDI	HPF 100 kHz
SD-SDI	HPF 1 kHz
Cursor Measurement	Amplitude measurement using Y cursors Time measurement using X cursors Rise time and fall time measurement using the TrTf cursor
Automatic Measurement Items	Eye pattern's amplitude Rise time (the time for the signal to rise from 20 to 80 % of its amplitude) Fall time (the time for the signal to fall from 80 to 20 % of its amplitude) DC offset Timing jitter Current jitter Rising edge overshoot Falling edge overshoot
DC Offset Accuracy	(Displayed value $\pm$ 5 %) $\pm$ 20 mV

## 2. SPECIFICATIONS

### 2.3.33 Jitter Display (LV 5770SER09A)

Display	Displays the jitter component of an SDI signal
3G-SDI, HD-SDI, SD-SDI	Displays channel A or B, whichever is selected
HD Dual Link	Displays link A or B, whichever is selected
Method	Phase detection method
Gain	×8, ×2, ×1
Measurement Range	
×8	0.00 to 1.20 UI
×2	1.20 to 4.80 UI
×1	4.80 to 9.60 UI
Frequency Response	
SD-SDI	600 kHz or more (with 0.2 UI input)
HD-SDI	2 MHz or more (with 0.2 UI input)
3G-SDI	2 MHz or more (with 0.3 UI input)
Time Axis	1 H, 2 H, 1 V, 2 V
Time Axis Accuracy	±3 %
Jitter Filter	
10 Hz	HPF 10 Hz
100 Hz	HPF 100 Hz
1 kHz	HPF 1 kHz
100 kHz	HPF 100 kHz
Timing	HPF 10 Hz
Alignment	
3G-SDI, HD-SDI	HPF 100 kHz
SD-SDI	HPF 1 kHz
Cursor Measurement	Jitter value measurement through the use of cursors
Automatic Measurement Display Feature	Displays the jitter value in seconds (sec) and unit intervals (UI)
Automatic Measurement Items	Timing jitter, current jitter
Accuracy	Input jitter frequency: 1 kHz. Filter setting: 10 Hz, within measurement range
0 UI < automatic measurement value ≤ 1 UI	±10 % + 0.05 UI
1 UI < automatic measurement value ≤ 7 UI	±10 %

## 2. SPECIFICATIONS

### 2.3.34 Eye Pattern and Jitter Detection (LV 5770SER09A)

Error Detection	On or off per item
Error Threshold Settings	Can be set individually for 3G-SDI, HD-SDI, and SD-SDI signals
Event Log	Stores eye patterns and jitter errors
Threshold Values	100 % of the values in the SMPTE standard
Eye-Pattern Amplitude	
Upper Limit	80 to 140 % (640 to 1120 mV)
Lower Limit	40 to 100 % (320 to 800 mV)
Rise Time	
3G-SDI	40 to 140 % (54.0 to 189.0 ps)
HD-SDI	40 to 140 % (108.0 to 378.0 ps)
SD-SDI	40 to 140 % (0.60 to 2.10 ns)
Fall Time	
3G-SDI	40 to 140 % (54.0 to 189.0 ps)
HD-SDI	40 to 140 % (108.0 to 378.0 ps)
SD-SDI	40 to 140 % (0.60 to 2.10 ns)
Difference between the Rise and Fall Times	
3G-SDI	40 to 140 % (20 to 70 ps)
HD-SDI	40 to 140 % (40 to 140 ps)
SD-SDI	40 to 140 % (0.20 to 0.70 ns)
Timing Jitter	
3G-SDI	10 to 200 % (0.20 to 4.00 UI, 67.4 to 1348.0 ps)
HD-SDI	10 to 200 % (0.10 to 2.00 UI, 67.4 to 1348.0 ps)
SD-SDI	10 to 200 % (0.02 to 0.40 UI, 0.07 to 1.48 ns)
Current Jitter	
3G-SDI	10 to 200 % (0.03 to 0.60 UI, 10.1 to 202.5 ps)
HD-SDI	10 to 200 % (0.02 to 0.40 UI, 13.5 to 270.0 ps)
SD-SDI	10 to 200 % (0.02 to 0.40 UI, 0.07 to 1.48 ns)
Rising Edge Overshoot	0 to 200 % (0.0 to 20.0 %)
Falling Edge Overshoot	0 to 200 % (0.0 to 20.0 %)
DC Offset	
Upper Limit	0 to 100 % (0 to 500 mV)
Lower Limit	0 to 100 % (0 to -500 mV)

### 2.3.35 Time Display Feature

Time Display	Current time, timecode (LV 5770SER08 and LV 5770SER09A)
Current Time Display	The time based on the internal clock
Timecode	LTC, VITC, D-VITC (SD-SDI only)
Compliant Standards	
LTC, VITC	SMPTE ST 12-2
D-VITC	SMPTE ST 266

## 2. SPECIFICATIONS

### 2.3.36 Alarm Output Feature

Display Indication When an error occurs or the fan stops rotating, an alarm is displayed.

#### Remote Control Connector Output

Each time that an error occurs or the fan stops rotating, a signal is transmitted from the remote control connector to indicate this occurrence.

### 2.3.37 Front Panel

Key LEDs All the keys are dimly back-lit, and the selected key is lit more brightly

Power Switch Stores whether the instrument is on or off

Last-Memory Feature Backs up the panel settings to memory

### 2.3.38 General Specifications

#### Environmental Conditions

Operating Temperature Range 0 to 40 °C

Operating Humidity Range 85 %RH or less (no condensation)

Optimal Temperature 10 to 30 °C

Operating Environment Indoors

Elevation Up to 2,000 m

Overvoltage Category II

Pollution Degree 2

#### Power Requirements

Voltage 90 to 250 VAC

Frequency 50/60 Hz

Power Consumption 120 W max.

#### Dimensions

215 (W) × 133.4 (H) × 435 (D) mm (excluding protrusions)

#### Weight

Approx. 4 kg (excluding options and accessories)

#### Accessories

Power cord .....	1
Cover/inlet stopper .....	1
Rack-mount, ANSI screw.....	2
15-pin D-sub connector .....	1
15-pin D-sub connector cover .....	1
37-pin D-sub connector (LV 5770SER42) .....	1
37-pin D-sub connector cover (LV 5770SER42).....	1
Instruction manual .....	1

### 3. PANEL DESCRIPTION

#### 3.1 Front Panel

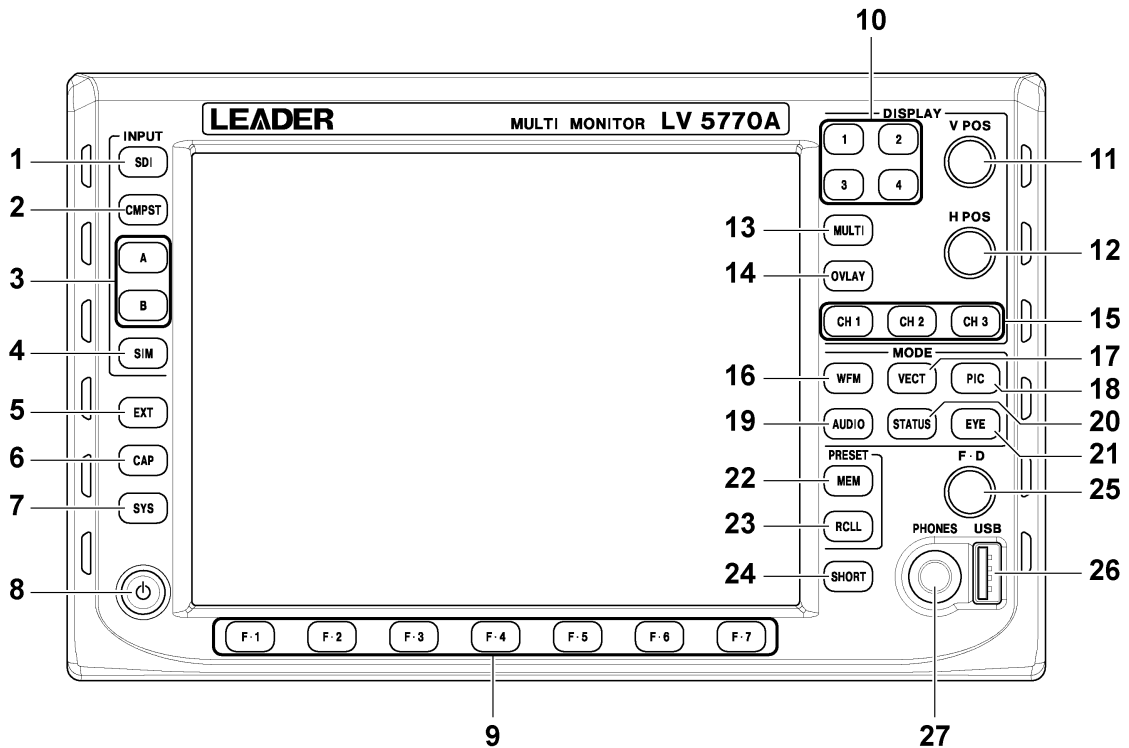

Figure 3-1 Front panel

Table 3-1 Front panel description

No.	Name	Description
1	SDI	Measures the SDI signal being applied to the LV 5770SER08 or LV 5770SER09A.
2	CMPST	Measures the composite signal or HD tri-level sync signal being applied to the LV 5770SER03A.
3	A/B	Select the input channel of the SDI signal. See section 5.4, "Selecting the Input Channel."
4	SIM	Switches the SDI signal input mode. In single input mode, this key's LED turns off. In simul mode, this key's LED lights. See section 5.4, "Selecting the Input Channel."
5	EXT	Switches the SDI signal sync signal. When the internal sync signal is being used, this key's LED turns off. When the external sync signal is being used, this key's LED lights. See section 4.4.4, "External Sync Signal Input (LV 5770SER08 and LV 5770SER09A)."
6	CAP	Captures the screen or frame data. See chapter 8, "CAPTURE FEATURE."
7	SYS	Configure settings for the instrument and the installed optional units. See chapter 7, "SYSTEM SETTINGS."
8	Power switch	Press this switch to turn the instrument on. Hold this switch down to turn the instrument off. See section 4.2, "Turning the Instrument On and Off."

### 3. PANEL DESCRIPTION

No.	Name	Description
9	F•1 to F•7	Carries out the corresponding function menu operation. See section 4.6.2, "Function Menu Operations."
10	1 to 4	Select the display area. See section 5.2, "Selecting the Display Area."
11	V POS	Adjusts the vertical position of the video signal waveform or eye pattern waveform. Press this key to return the position to the reference position.
12	H POS	Adjusts the horizontal position of the video signal waveform or eye pattern waveform. Press this key to return the position to the reference position.
13	MULTI	Switches the display format. When the multi-screen display (2- or 4-screen) is in use, this key's LED lights. When the 1-screen display is in use, this key's LED turns off. See section 5.1, "Selecting the Display Format"
14	OVLAY	Switches the video signal waveform display format. When the overlay display (video signal waveforms are displayed on top of each other) is in use, this key's LED lights. When the parade display (video signal waveforms are displayed side by side) is in use, this key's LED turns off.
15	CH 1 to CH 3	Turn each channel of the video signal waveform on and off. When a channel is displaying a signal, the corresponding key's LED lights.
16	WFM	Shows the video signal waveform display. This requires the LV 5770SER03A, LV 5770SER08, or LV 5770SER09A. See section 5.5, "Selecting the Display Mode"
17	VECT	Shows the vector display. This requires the LV 5770SER03A, LV 5770SER08, or LV 5770SER09A. See section 5.5, "Selecting the Display Mode"
18	PIC	Shows the picture display. This requires the LV 5770SER03A, LV 5770SER08, or LV 5770SER09A. See section 5.5, "Selecting the Display Mode"
19	AUDIO	Shows the audio display. This requires the LV 5770SER41 or LV 5770SER43. See section 5.5, "Selecting the Display Mode"
20	STATUS	Shows the status display. This requires the LV 5770SER03A, LV 5770SER08, or LV 5770SER09A. See section 5.5, "Selecting the Display Mode"
21	EYE	Shows the eye pattern display. This requires the LV 5770SER09A. See section 5.5, "Selecting the Display Mode"
22	MEM	Registers or deletes a single preset, or copies all presets. See chapter 9, "PRESET FEATURE."
23	RCLL	Loads a preset. See chapter 9, "PRESET FEATURE."
24	SHORT	Loads panel settings, adjusts the volume, saves a screen capture to the USB memory device, or adjusts the intensity. See sections 4.6.5, "Operating the Shortcut Key" and 7.4, "Setting the Shortcut Key."
25	F•D	This knob is used to specify a numeric value or to move cursors. In most cases, pressing this knob will return the value you are adjusting to its default setting.
26	USB port	This USB port is used to save and load various kinds of data.
27	PHONES	This is a standard-plug headphone jack. When a pair of headphones are

### 3. PANEL DESCRIPTION

No.	Name	Description
		connected to this jack, the LV 5770A transmits the audio that is embedded in an SDI signal or the audio that is applied to the LV 5770SER41 or LV 5770SER43. This requires the LV 5770SER41 or LV 5770SER43.

### 3.2 Rear Panel

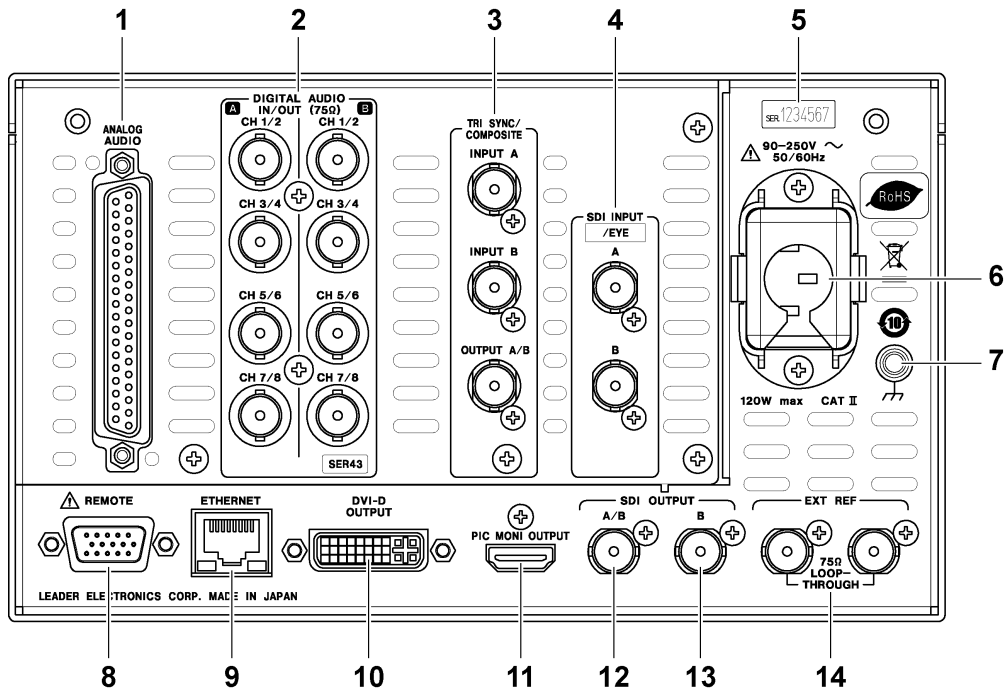

Figure 3-2 Rear panel

Table 3-2 Rear panel description

No.	Name	Description
1	ANALOG AUDIO	This is the LV 5770SER42 I/O connector. This is used to receive and transmit audio signals. See section 4.4.7, "Analog Audio Signal I/O (LV 5770SER42)."
2	DIGITAL AUDIO IN/OUT	These are LV 5770SER41 or LV 5770SER43 I/O connectors. These are used to receive audio signals. By changing the system settings, you can also transmit audio signals from these connectors. "SER43" is displayed on the LV 5770SER43. See section 4.4.6, "Digital Audio Signal I/O (LV 5770SER41 and LV 5770SER43)."
3	TRI SYNC/ COMPOSITE	These are LV 5770SER03A I/O connectors. These are used to receive and transmit composite signals and HD tri-level sync signals. See section 4.4.5, "Composite Signal I/O (LV 5770SER03A)."
4	SDI INPUT	These are LV 5770SER08 or LV 5770SER09A input connectors. These are used to receive SDI signals. "/EYE" is displayed on the LV 5770SER09A. See section 4.4.1, "SDI Signal Input (LV 5770SER08 and LV 5770SER09A)."
5	Serial number label	The instrument's serial number is printed on this label.



### 3. PANEL DESCRIPTION

No.	Name	Description
6	AC inlet	Attach the included cover/inlet stopper to the AC inlet. See section 4.1, "Cover/Inlet Stopper."
7	Ground terminal	This is used to connect the instrument to an external ground.
8	REMOTE	This is a D-sub, 15-pin remote control connector. This can be used to execute actions such as loading presets. See chapter 10, "REMOTE CONTROL."
9	ETHERNET	This is the Ethernet port. See chapter 11, "ETHERNET REMOTE CONTROL."
10	DVI-D OUTPUT	This is the DVI-D output connector. This connector is used to transmit the screen image. See section 4.4.8, "DVI-D Output."
11	PIC MONI OUTPUT	This is used to transmit a TMDS signal that has been converted from an SDI signal applied to an SDI INPUT connector. See section 4.4.3, "Picture Monitor Output (LV 5770SER08 and LV 5770SER09A)."
12	SDI OUTPUT A/B	This generates the reclocked signal of the SDI signal received through an SDI INPUT connector. There are two modes: a mode that generates the signal from the currently selected channel and a mode that is fixed to generating the signal from channel A. See section 4.4.2, "SDI Signal Output (LV 5770SER08 and LV 5770SER09A)."
13	SDI OUTPUT B	This generates the reclocked signal of the SDI signal received through the SDI INPUT B connector. See section 4.4.2, "SDI Signal Output (LV 5770SER08 and LV 5770SER09A)."
14	EXT REF	These are loop-through external sync signal input connectors. See section 4.4.4, "External Sync Signal Input (LV 5770SER08 and LV 5770SER09A)."

## 4. BEFORE YOU BEGIN MEASURING

### 4.1 Cover/Inlet Stopper

A cover/inlet stopper is included with the instrument. Use this device to prevent the power cord from being pulled free of the AC inlet.

#### 4.1.1 Attaching the Cover/Inlet Stopper

- 1. Cover the power cord with the cover/inlet stopper.**

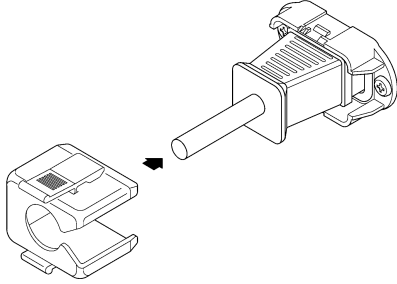

Figure 4-1 Attaching the cover/inlet stopper; step 1

- 2. Push the cover/inlet stopper, until you hear a click, to attach it to the AC inlet.**

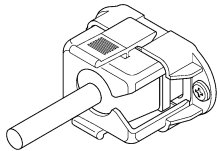

Figure 4-2 Attaching the cover/inlet stopper; step 2

- 3. Check that the cover/inlet stopper is securely attached to the AC inlet.**

#### 4.1.2 Removing the Cover/Inlet Stopper

- 1. Release the lock by using two fingers to press the cover/inlet stopper levers.**

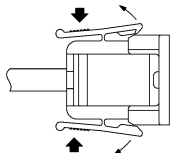

Figure 4-3 Removing the cover/inlet stopper; step 1

- 2. Pull the cover/inlet stopper away from the AC inlet.**

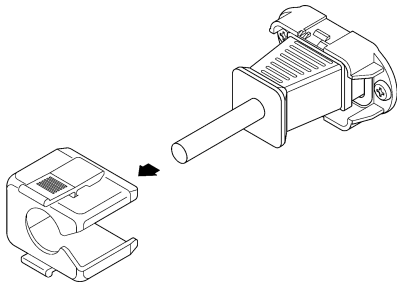

Figure 4-4 Removing the cover/inlet stopper; step 2

## 4.2 Turning the Instrument On and Off

To turn on the power, press the power switch. The power switch LED lights, and the instrument turns on. When you turn on the power, the LV 5770A starts with the same panel settings that were being used when it was last turned off.

To turn off the power, hold down the power switch for one second or more. The power switch LED and the instrument turn off.

## 4.3 Optional Units

This instrument only functions as a measuring instrument after at least one optional unit (sold separately) is installed.

You can include units as factory options. Contact your local LEADER agent. You cannot install or uninstall units. Do not remove the instrument's case or panels for any reason.

Table 4-1 Unit types

Unit	Name	Main Function
LV 5770SER03A	TRI SYNC/COMPOSITE	Composite signal and HD tri-level sync signal measurement
LV 5770SER08	SDI INPUT	SDI signal measurement
LV 5770SER09A	SDI INPUT/EYE	SDI signal measurement and eye pattern display
LV 5770SER41 LV 5770SER43	DIGITAL AUDIO	<ul style="list-style-type: none"> <li>• Digital audio signal measurement</li> <li>• Measurement of audio signals embedded in SDI signals</li> <li>• Dolby signal measurement</li> </ul>
LV 5770SER42	ANALOG AUDIO	Analog audio signal measurement

## 4.4 Signal I/O

### 4.4.1 SDI Signal Input (LV 5770SER08 and LV 5770SER09A)

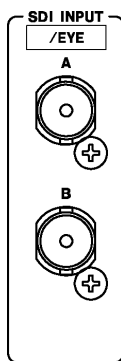

Figure 4-5 SDI input connectors

\* “/EYE” is displayed on the LV 5770SER09A.

- **Input Format**

This instrument supports 3G, HD, HD dual link, and SD signals. Apply signals that this unit supports to its SDI input connectors.

If you are measuring embedded audio in simul mode, apply signals synchronized to channels A and B.

See section 2.3.1, “SDI Video Signal Formats and Standards (LV 5770SER08 and LV 5770SER09A).”

#### 4. BEFORE YOU BEGIN MEASURING

- **Terminators**

The SDI input connectors are terminated internally at 75  $\Omega$ , so there is no need to connect terminators to them. Connect cables with a characteristic impedance of 75  $\Omega$  to the input connectors.

- **Measurement Channels**

To switch to a measurement channel, press A or B. Also, when the SIM key's LED is lit, you can measure the signal applied to SDI INPUT A and the signal applied to SDI INPUT B simultaneously (excluding when the status display or the eye pattern display is in use).

See section 5.4, "Selecting the Input Channel."

- **Cables**

It has been confirmed for each channel that errors do not occur when the LV 5770A receives an 800 mVp-p stress pattern through the following cables.

3G: LS-5CFB cable, 70 m  
HD: LS-5CFB cable, 110 m  
SD: L-5C2V cable, 260 m

- **Eye Pattern Measurement (LV 5770SER09A)**

Use a color bar signal to measure the amplitude of an eye pattern and jitter values.

Because measured values are influenced greatly by the cable that is used, we recommend that you use a high-quality, low-loss 5C-FB or Belden 1694A measurement cable. Before connecting the cables, check that the cable connectors are not dirty, deformed, or otherwise damaged.

Especially if you are measuring the amplitude of eye patterns, rise time, fall time, rising edge overshoot, or falling edge overshoot of relay instruments, use one of the cables described above (1 meter in length).

Static electricity build-up in the cables can cause damage to the input circuit. Discharge any built-up static electricity before you connect the cables.

4.4.2 SDI Signal Output (LV 5770SER08 and LV 5770SER09A)

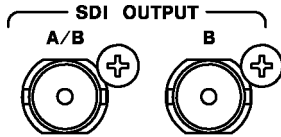

Figure 4-6 SDI output connectors

A reclocked signal of the signal applied to SDI INPUT A or SDI INPUT B is generated from SDI OUTPUT A/B. You can switch between the two input signals by pressing A or B. In single input mode, channel A or B—whichever channel's corresponding key is lit—is generated. In simul mode, the channel that has been selected with the ■ on the screen is generated. (In a HD dual link signal, this is fixed to link A.) You can also configure the system settings so that the signal generated from this connector is fixed to the reclocked signal of the signal applied to SDI INPUT A.

SDI OUTPUT B generates the reclocked signal of the signal applied to SDI INPUT B. Regardless of the types of signals that are transmitted, connect the signals to SDI compatible picture monitors or other devices.

See section 7.1.2, “Rear Panel Settings.”

4.4.3 Picture Monitor Output (LV 5770SER08 and LV 5770SER09A)



Figure 4-7 Picture monitor output connector

This is used to transmit a TMDS signal that has been converted from an SDI signal applied to SDI INPUT A or SDI INPUT B. Use a commercially available HDMI cable to connect the LV 5770A to an LCD monitor.

Press A or B to select the output channel. For HD dual link signals, a signal consisting of the combination of links A and B is generated. For 3G-B (2map) signals, the selected stream (1 or 2) is generated.

The output signal's format, quantization, and stream can be selected in section 7.1.2, “Rear Panel Settings.”

The following input signals are not supported.

- 720p/24, 23.98
- 1080PsF/30, 29.97, 25, 24, 23.98
- 1080p/24, 23.98 (2048 × 1080)
- 1080PsF/24, 23.98 (2048 × 1080)

The output audio signal channel mapping is fixed as shown below.

Ch 8	Ch 7	Ch 6	Ch 5	Ch 4	Ch 3	Ch 2	Ch 1
RRC	RLC	RR	RL	FC	LFE	FR	FL

4.4.4 External Sync Signal Input (LV 5770SER03A, LV 5770SER08, and LV 5770SER09A)

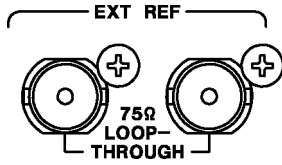

Figure 4-8 External sync signal input connectors

You can apply an external signal to show the video signal waveform display, vector display, and status display (phase difference display). (\*1)

Apply an external sync signal to an external sync signal input connector, and then press EXT. The LV 5770A determines the sync signal format automatically.

As shown in the figure below, the external sync signal input connectors are loop-through. Apply the input signal to one of the two connectors, and terminate the other connector at 75 Ω, or connect it to another 75 Ω device. If you connect to another device, be sure to terminate the device at the end of the chain at 75 Ω. Connect cables with a characteristic impedance of 75 Ω to the input connectors.

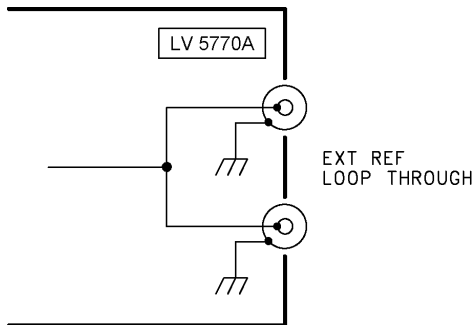

Figure 4-9 Loop-through

- \*1 The following formats can not be used in external sync mode.
- HD dual link's 1080p/60, 1080p/59.94, and 1080p/50
  - 3G's 720p/30, 720p/29.97, 720p/25, 720p/24, and 720p/23.98

#### 4. BEFORE YOU BEGIN MEASURING

External sync signals that are compatible with each input signal are indicated with a check mark in the following table.

Table 4-2 External sync signal formats (SD, HD, and HD dual link)

		Input Signal Format																									
		SD		HD																							
		HD dual link																									
		525i/59.94	625i/50	1080i/60	1080i/59.94	1080i/50	1080PsF/30	1080PsF/29.97	1080PsF/25	1080PsF/24	1080PsF/23.98	1080p/30	1080p/29.97	1080p/25	1080p/24	1080p/23.98	720p/60	720p/59.94	720p/50	720p/30	720p/29.97	720p/25	720p/24	720p/23.98			
External Sync Signal Format	NTSC with 10 field ID (59.94 Hz)(*1)	✓		✓		✓				✓		✓			✓		✓			✓					✓		
	NTSC (59.94 Hz)	✓		✓			✓					✓					✓			✓							
	PAL (50 Hz)		✓		✓			✓				✓						✓			✓						
	1080i/60			✓		✓																					
	1080i/59.94				✓		✓																				
	1080i/50					✓		✓																			
	1080PsF/30						✓																				
	1080PsF/29.97							✓																			
	1080PsF/25								✓																		
	1080PsF/24									✓																	
	1080PsF/23.98										✓																
	1080p/30											✓															
	1080p/29.97												✓														
	1080p/25													✓													
	1080p/24														✓												
	1080p/23.98															✓											
	720p/60																✓										
	720p/59.94																	✓									
	720p/50																		✓								
	720p/30																			✓							
720p/29.97																				✓							
720p/25																					✓						
720p/24																						✓					
720p/23.98																							✓				

\*1 If the input signal is 1080PsF/23.98 or 1080p/23.98, the 10 field ID is automatically detected.

\* In the phase difference measurement of the LV 5770SER03A, apply an external sync signal whose format is the same as the input signal.

4. BEFORE YOU BEGIN MEASURING

Table 4-3 External sync signal formats (3G)

		Input Signal Format																		
		3G-A																		
		3G-B																		
			3G-B (2map)																	
		1080p/60	1080p/59.94	1080p/50	1080i/60	1080i/59.94	1080i/50	1080PsF/30	1080PsF/29.97	1080PsF/25	1080PsF/24	1080PsF/23.98	1080p/30	1080p/29.97	1080p/25	1080p/24	1080p/23.98	720p/60	720p/59.94	720p/50
External Sync Signal Format	NTSC with 10 field ID (59.94 Hz)(*1)	✓			✓			✓				✓		✓			✓		✓	
	NTSC (59.94 Hz)		✓		✓			✓						✓					✓	
	PAL (50 Hz)			✓		✓			✓						✓					✓
	1080i/60	✓			✓		✓													
	1080i/59.94		✓		✓			✓												
	1080i/50			✓		✓			✓											
	1080PsF/30						✓													
	1080PsF/29.97							✓												
	1080PsF/25								✓											
	1080PsF/24									✓										
	1080PsF/23.98										✓									
	1080p/30												✓							
	1080p/29.97													✓						
	1080p/25														✓					
	1080p/24															✓				
	1080p/23.98																✓			
	720p/60																	✓		
	720p/59.94																		✓	
	720p/50																			✓

\*1 If the input signal is 1080PsF/23.98 or 1080p/23.98, the 10 field ID is automatically detected.



4.4.5 Composite Signal I/O (LV 5770SER03A)

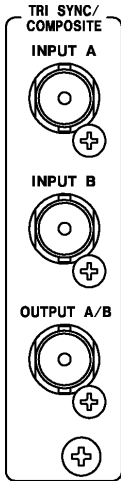

Figure 4-10 Composite I/O connectors

- **Signal Input**

Apply an NTSC/PAL composite signal or an HD tri-level sync signal to INPUT A or INPUT B.

To switch the measurement channel, press A or B. Note that pressing the SIM key has no effect. You cannot measure the signals that are being applied to INPUT A and INPUT B simultaneously.

- **Signal Output**

Press A or B to switch between the signals that are being applied to INPUT A and INPUT B. The selected signal is generated.

Connect the signals to composite-signal compatible picture monitors or other devices.

4.4.6 Digital Audio Signal I/O (LV 5770SER41 and LV 5770SER43)

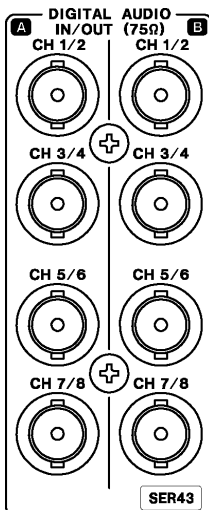

Figure 4-11 Digital audio I/O connectors

\* “SER43” is displayed on the LV 5770SER43.

#### 4. BEFORE YOU BEGIN MEASURING

Use the system settings to set the function of the audio I/O connectors to input or output. Before you apply signals, check that the function of the connectors has been set to input. Failing to do so could damage the instrument. Use the output signal for monitoring purposes. See section 7.1.2, "Rear Panel Settings."

#### 4.4.7 Analog Audio Signal I/O (LV 5770SER42)

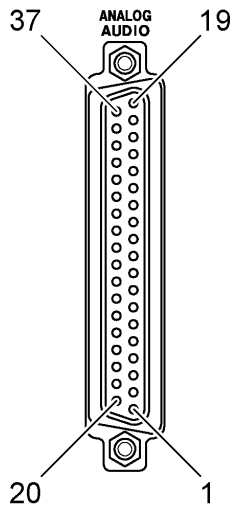

Figure 4-12 Analog audio I/O connector (female, inch screws)

Table 4-4 Analog audio I/O connector pinout example

Pin No.	Name	Pin No.	Name	I/O	Function
37	INPUT1+	19	INPUT1-	I	Analog audio input 1
36	INPUT2+	18	INPUT2-	I	Analog audio input 2
35	INPUT3+	17	INPUT3-	I	Analog audio input 3
-	-	16	GND	-	Ground
34	INPUT4+	15	INPUT4-	I	Analog audio input 4
33	INPUT5+	14	INPUT5-	I	Analog audio input 5
32	INPUT6+	13	INPUT6-	I	Analog audio input 6
31	GND	-	-	-	Ground
30	INPUT7+	12	INPUT7-	I	Analog audio input 7
29	INPUT8+	11	INPUT8-	I	Analog audio input 8
-	-	10	GND	-	Ground
28	OUTPUT1+	9	OUTPUT1-	O	Analog audio output 1
27	OUTPUT2+	8	OUTPUT2-	O	Analog audio output 2
26	OUTPUT3+	7	OUTPUT3-	O	Analog audio output 3
25	OUTPUT4+	6	OUTPUT4-	O	Analog audio output 4
24	OUTPUT5+	5	OUTPUT5-	O	Analog audio output 5
23	OUTPUT6+	4	OUTPUT6-	O	Analog audio output 6
22	OUTPUT7+	3	OUTPUT7-	O	Analog audio output 7
21	OUTPUT8+	2	OUTPUT8-	O	Analog audio output 8
20	GND	1	GND	-	Ground

## 4. BEFORE YOU BEGIN MEASURING

- **Signal Input**

You can measure up to eight channels of analog audio signals.

In the system settings, set ANALOG AUDIO to INPUT. If it is set to OUTPUT, you cannot perform measurements.

For information on the ANALOG AUDIO setting, see section 7.1.2, "Rear Panel Settings."

- **Signal Output**

You can perform a D/A conversion on and generate up to eight channels of embedded audio signals or external digital audio signals. (You cannot generate the applied analog audio signal.) Use the output signal for monitoring purposes.

In the system settings, set ANALOG AUDIO to OUTPUT. If it is set to INPUT, you cannot generate output.

The nominal output impedance of the connectors is 50  $\Omega$ . In addition, the output level is optimized for a load impedance of 100 k $\Omega$ .

- **About the Unit**

LV 5770A audio signals are displayed in units of dBFS with 4 dBu scaled to -20 dBFS. A conversion table between dBu and dBFS is shown below.

Table 4-5 dBu, dBFS conversion table

dBu	dBFS
+ 24	0
+ 18	- 6
+ 4	- 20
0	- 24
- 16	- 40
- 36	- 60
- 66	- 90

### 4.4.8 DVI-D Output

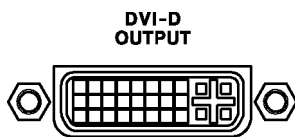

Figure 4-13 DVI-D output connector

The DVI-D output connector transmits the LV 5770A screen image. Using a commercially available DVI-D cable, connect the LV 5770A to an XGA (1024 × 768) display.

To hide pillarboxing, change the display's aspect ratio in the system settings.

See section 7.1.2, "Rear Panel Settings."

4.5 General Display Explanation

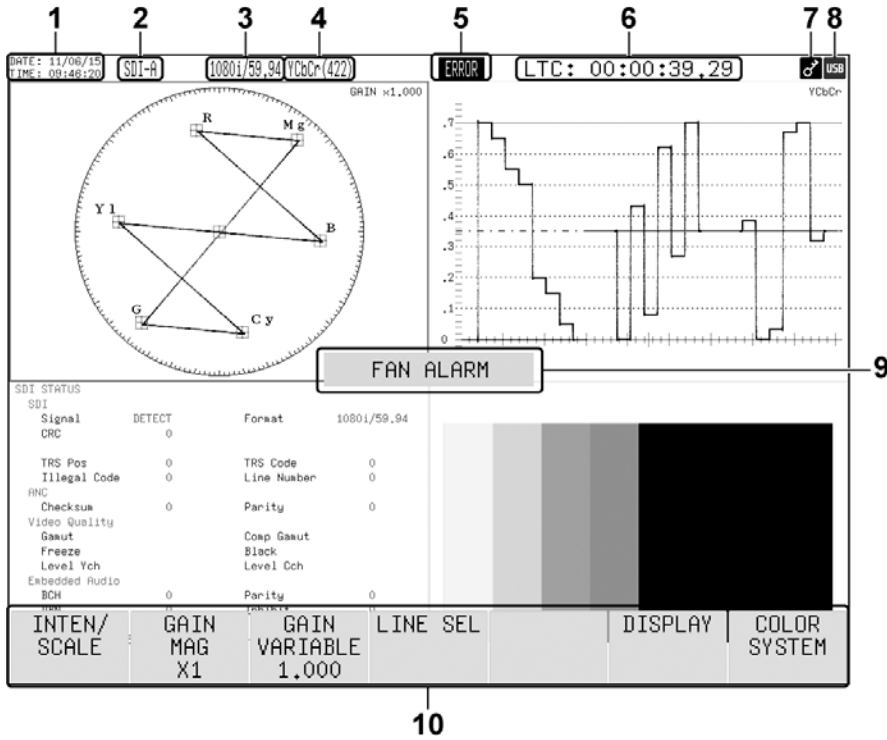

Figure 4-14 General display explanation

Table 4-6 General display explanation

No.	Name	Description
1	Date and time	The date and time are displayed here. See sections 7.2.1, "General Settings" and 7.2.4, "Setting the Date and Time."
2	Input signal (LV 5770SER03A, LV 5770SER08, and LV 5770SER09A)	The input signal (SDI or CMP) and the measurement channel are displayed here. See section 7.2.1, "General Settings."
3	Format (LV 5770SER03A, LV 5770SER08, and LV 5770SER09A)	The input signal format is displayed here. See section 7.2.1, "General Settings."
4	Color system (LV 5770SER08 and LV 5770SER09A)	The SDI signal color system is displayed here. See section 7.2.1, "General Settings."
5	Error indication (LV 5770SER08 and LV 5770SER09A)	This is displayed when an input signal error has occurred. Switching input signals or input channels may cause errors to be displayed.
6	Timecode (LV 5770SER08 and LV 5770SER09A)	The SDI signal timecode is displayed here. See section 7.2.1, "General Settings."

## 4. BEFORE YOU BEGIN MEASURING

No.	Name	Description
7	Key lock indication	This symbol appears when the key lock is enabled. See section 4.6.4, "Enabling and Releasing the Key Lock."
8	USB memory indication	This appears when a USB memory device is connected to the LV 5770A. This indicator is normally green, but it changes to red when the USB memory device is being accessed. Do not turn the power off or remove the USB memory device when the indicator is red.
9	Alarm indication	This displays various alarms. If either of the following alarms is displayed, contact your local LEADER agent. FAN ALARM: This appears when there is a problem with the fan. OVER HEAT: This appears when the internal temperature has risen to an abnormal level.
10	Function menu	This displays menus for specifying a variety of settings. See section 4.6.2, "Function Menu Operations."

### 4.6 Panel Operation Basics

#### 4.6.1 Displaying the Function Menu

The function menu is used to specify a variety of settings. If you do not perform any operations for 5 seconds, the function menu will automatically disappear. (You can change the length of time before the menu disappears or prevent it from disappearing in the system settings.)

Some menus, such as the system menu, do not automatically disappear.

See section 7.2.1, "General Settings."

If the menu disappears, carry out one of the following operations to display it again. Note that if you carry out one of these operations when the menu is displayed, the menu will disappear.

- **Press a Display Mode Key**

Press the display mode key (WFM, VECT, PIC, AUDIO, STATUS, or EYE) that corresponds to the currently selected display mode to display the menu. When you perform this operation, the top-level menu is displayed.

- **Press a Function Key**

Press a function key, the function dial (F•D), or the display area key (1 to 4) that corresponds to the currently selected display area to display the menu. When you perform this operation, the menu is displayed at the level that was displayed before it disappeared.

### 4.6.2 Function Menu Operations

This section explains how to operate the function menu, using the function menu on the vector display as an example.

The function menu items correspond to **F•1** to **F•7**.

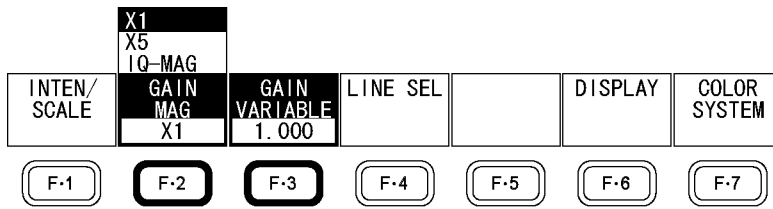

Figure 4-15 Function menu operations

- **Selecting a Setting**

To select a setting from a list like the one shown in the figure above for **F•2** GAIN MAG, press **F•2** repeatedly to select the setting you want. The setting changes each time you press **F•2**. After you stop pressing **F•2**, the setting is confirmed and the pop-up menu disappears.

- **Changing a Value**

To set the value of a setting like **F•3** GAIN VARIABLE, which is shown in the figure above, press **F•3**, and then turn the function dial (F•D). You can reset most settings to their default values by pressing the function dial (F•D).

### 4.6.3 Tab Menu Operations

Normally, the function menus are used to configure the various settings. However, tab menus—such as that shown below—are displayed in some situations.

This section explains how to operate the tab menu, using the GENERAL SETUP tab menu as an example.

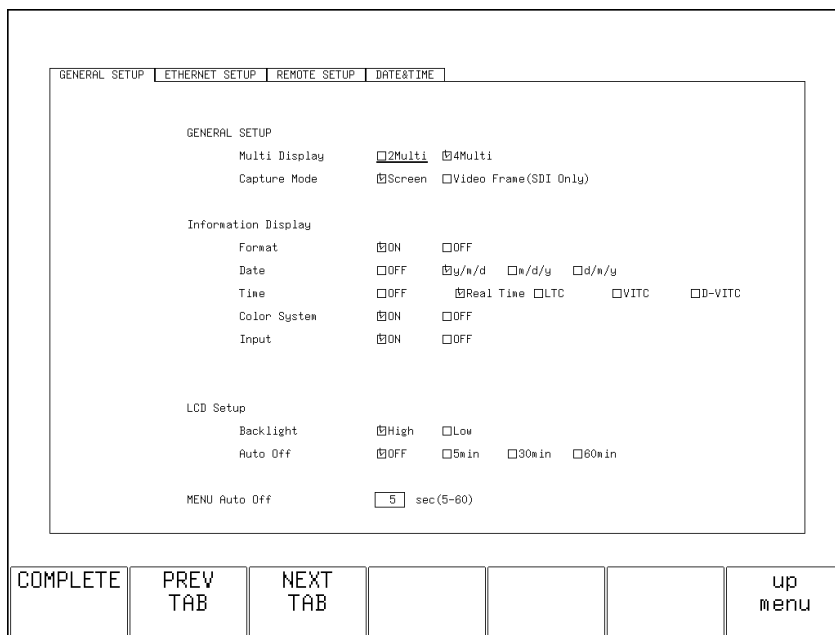

Figure 4-16 Tab menu operations

#### 4. BEFORE YOU BEGIN MEASURING

- **To Move the Cursor**

To move the cursor, turn the function dial (F•D). Depending on what you are setting, you may not be able to move the cursor.

- **To Change the Tab**

When there are multiple tabs such as in the figure above, press **F•2** PREV TAB and **F•3** NEXT TAB to change between tabs. Even if you switch to another tab, the settings are not confirmed until you press **F•1** COMPLETE.

- **To Select a Check Box**

Move the cursor to the check box that you want to select, and press the function dial (F•D).

- **To Enter a Value**

Move the cursor to the item that you want to enter the value for, and press the function dial (F•D). When you push the function dial (F•D), the color of the cursor changes from blue to yellow, and you can set the value. Turn the function dial (F•D) to set the value. To confirm the value that you have set, press the function dial (F•D) again.

- **To Confirm the Settings**

Press **F•1** COMPLETE to apply the settings from all the tabs and return to the screen that is one level up.

- **To Cancel the Settings**

Press **F•7** CANCEL to cancel the settings from all the tabs and return to the screen that is one level up.

#### 4.6.4 Enabling and Releasing the Key Lock

You can prevent accidental operations on the LV 5770A by enabling the key lock. The key lock disables all LV 5770A keys except for the power switch. (Remote control is still valid even if the key lock is enabled.)

- **Enabling the Key Lock**

Hold down SYS until the message “KEYLOCK” is displayed on the screen. While the key lock is enabled, a key symbol appears in the upper right of the screen.

- **Releasing the Key Lock**

Hold down SYS until the message “KEYLOCK Canceled.” is displayed on the screen.

#### 4.6.5 Operating the Shortcut Key

You can press SHORT to perform a feature that you have assigned to the key in the system settings. First, assign the feature to the key by pressing **F•4** SHORTCUT KEY on the system menu.

See section 7.4, "Setting the Shortcut Key."

- **DIRECT**

The panel settings that are registered to the SHORT key are loaded.

To register the panel settings, configure the LV 5770A to the settings that you want to register, press MEM, and then press SHORT.

- **VOLUME**

You can adjust the headphone volume by pressing SHORT and then turning the function dial (F•D). To return to the previous screen, press SHORT again.

- **CAP&WRIT**

A screen capture is taken and saved to a USB memory device. Set the format of the file that you want to save on the capture menu.

See section 8.1.3, "Saving to a USB Memory Device."

- **INTEN**

You can adjust the waveform intensity by selecting the waveform display, pressing SHORT, and then turning the function dial (F•D). To return to the previous screen, press SHORT again.

- **MENU OFF**

The menu is cleared. You can select this when Auto Off under GENERAL SETUP in the system settings is set to OFF.

See section 7.2.1, "General Settings."



## 5. BASIC OPERATING PROCEDURES

This chapter explains the basic operating procedures of the LV 5770A. We recommend that you follow these basic operations until you fully understand how the LV 5770A is designed to operate.

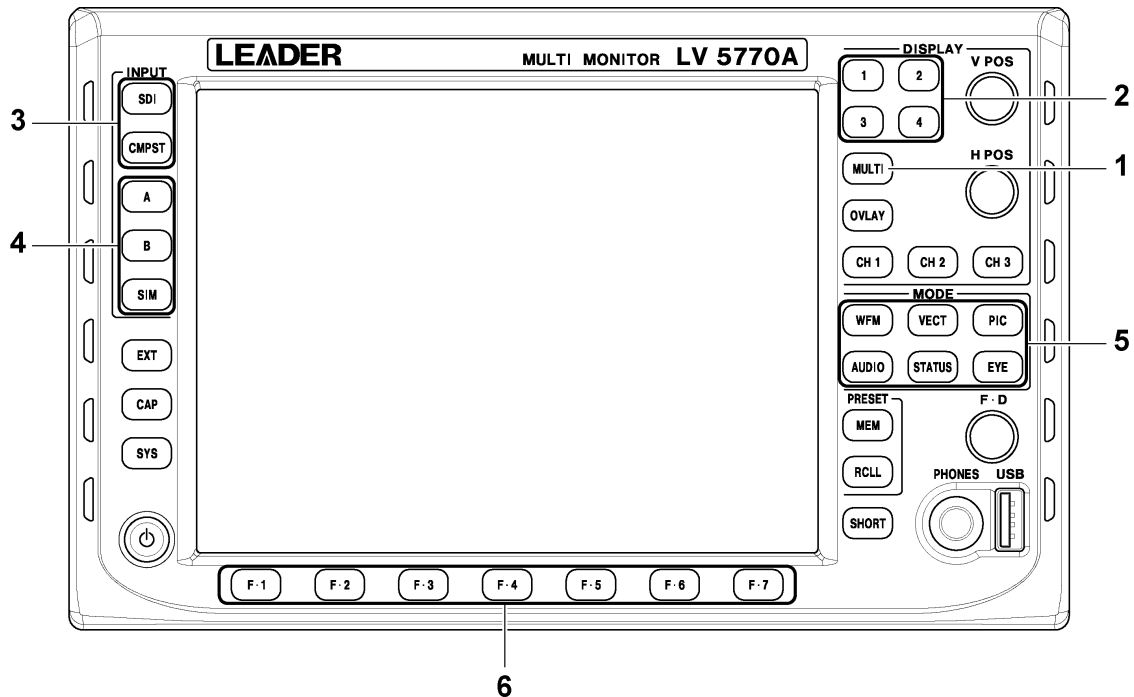

Figure 5-1 Operating procedures

### 1. Select the display format.

Press MULTI to select the 1-screen display or the multi-screen display.  
See section 5.1, "Selecting the Display Format"

### 2. Select the display area.

Press a key from 1 to 4 to select the display area.  
See section 5.2, "Selecting the Display Area."

### 3. Select the input signal.

Press SDI or CMPST to select the input signal.  
See section 5.3, "Selecting the Input Signal."

### 4. Select the input channel.

Press A or B to select the input channel.  
Press SIM to measure channel A and channel B simultaneously.  
See section 5.3, "Selecting the Input Channel."

### 5. Select the display mode.

Press WFM, VECT, PIC, AUDIO, STATUS, or EYE to select the display mode.  
See section 5.5, "Selecting the Display Mode"

**6. Configure the display mode.**

Use the function keys and the related keys to configure the settings.  
See section 4.6, "Panel Operation Basics."

**7. If you selected the multi-screen display in step 1, repeat steps 2 to 6 to specify the settings for all the areas.**

5.1 Selecting the Display Format

The LV 5770A supports both a multi-screen display and a 1-screen display. Press MULTI to switch between the 1-screen display and the multi-screen display. The key's LED lights when the multi-screen display is active.

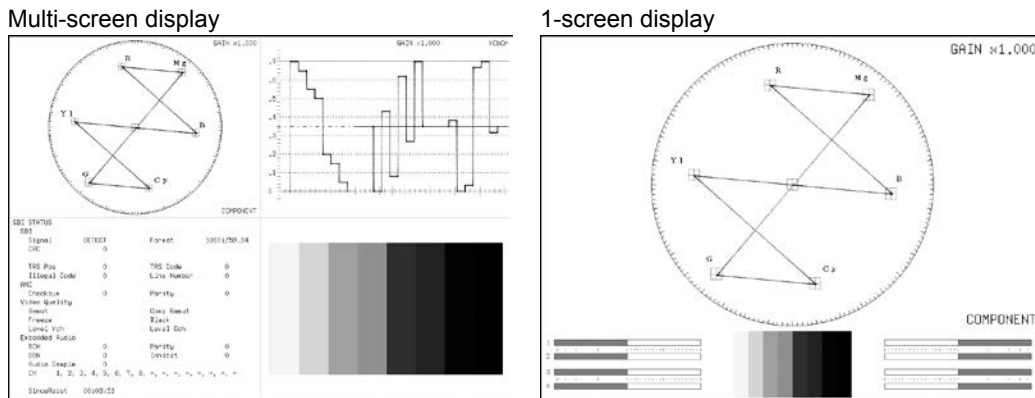

Figure 5-2 Selecting the display format

There are 2-screen and 4-screen multi-screen displays. The default setting is the 4-screen multi display, but you can use the system settings to change to the 2-screen multi display. See section 7.2.1, "General Settings."

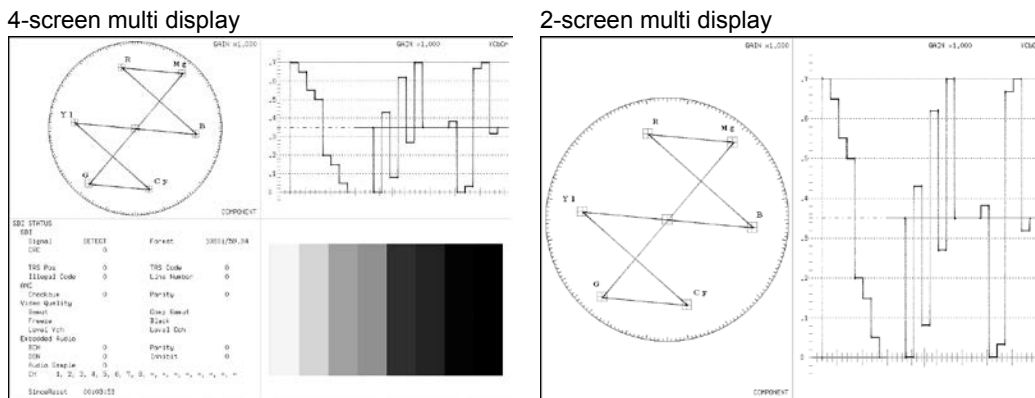

Figure 5-3 Multi-screen displays

## 5.2 Selecting the Display Area

The LV 5770A is composed of four screens.

Press a key from 1 to 4 to select the area that you want to operate. When the menu is being displayed on the multi-screen display, the selected area is displayed with a blue border.

Keys 1 to 4 are assigned as follows:

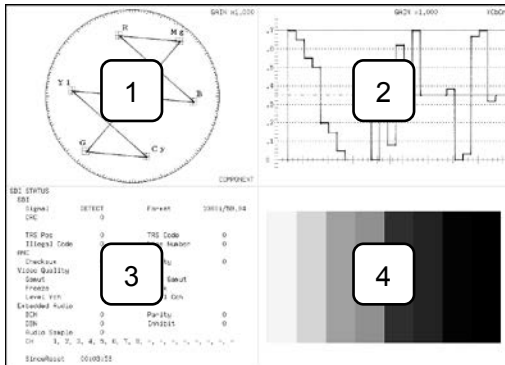

Figure 5-4 4-screen multi display

Additionally, the display area that is selected when you press a key from 1 to 4 is as follows:

- **4-Screen Multi Display**

All areas are displayed at all times.

- **2-Screen Multi Display**

If you press 1 or 2, areas 1 and 2 are displayed. If you press 3 or 4, areas 3 and 4 are displayed.

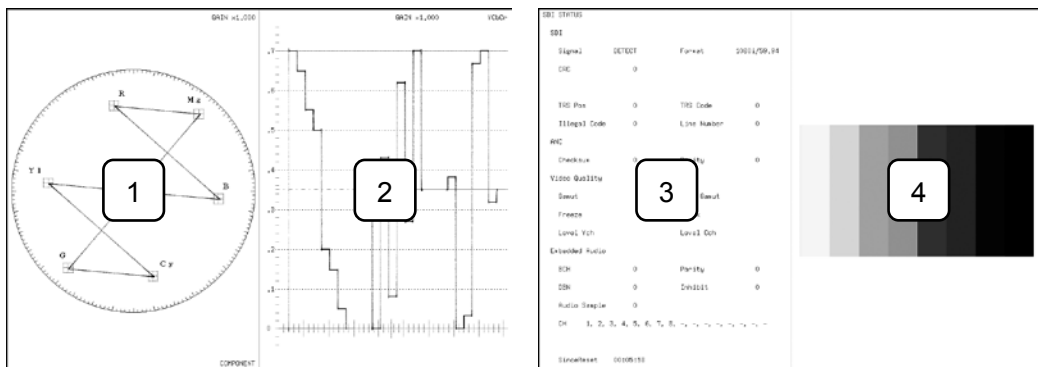

Figure 5-5 2-screen multi display

- **1-Screen Display**

Only the area that you selected by pressing a key from 1 to 4 is displayed.

## 5.3 Selecting the Input Signal

Depending on the signal that you want to measure, press SDI or CMPST.

On the audio display, regardless of the signal that you select here, the signal that you selected with INPUT SELECT on the audio menu is measured.

The input signal settings are shared between areas 1 to 4. You cannot configure the settings differently for each area.

### 5.4 Selecting the Input Channel

When you are measuring an SDI signal or composite signal, press A or B to select the input channel. Press SIM to measure both channel A and B simultaneously. However, you cannot measure both channels simultaneously:

- When you are measuring SDI signals on the status display or eye pattern display.
- When you are measuring SDI signals with HD dual link or 3G-B(2map) input.
- When you are measuring composite signals.

The input channel setting is shared between areas 1 to 4. You cannot set the setting differently for each area.

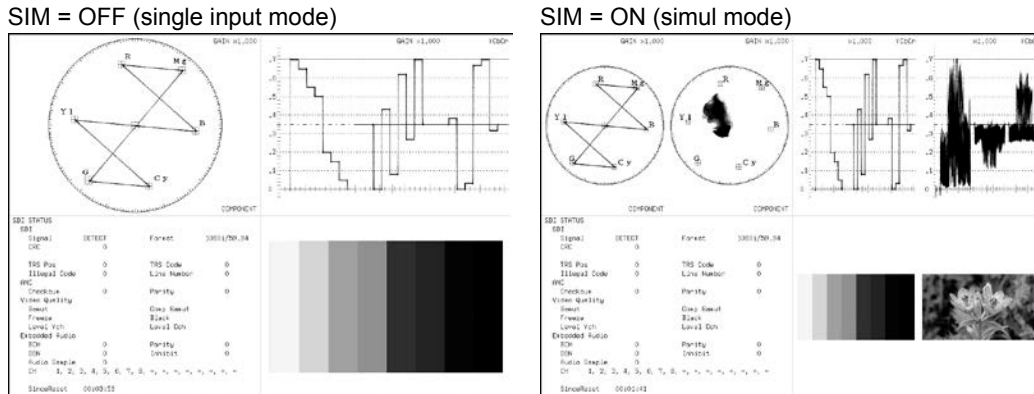

Figure 5-6 Single input mode and simul mode

### 5.5 Selecting the Display Mode

The LV 5770A has six display modes: WFM (video signal waveform display), VECT (vector display), PIC (picture display), AUDIO (audio display), STATUS (status display), and EYE (eye pattern display). Press MODE on the front panel to select the display mode.

On the multi-screen display, you cannot set different areas to the same display mode. The display mode that you specify last takes effect. However, VECT can be displayed simultaneously in the vector display and 5 bar display.

The optional units that are required for each display mode are shown below.

Table 5-1 Optional units required for display modes

Display Mode	Required Optional Unit	Notes
WFM	LV 5770SER03A, LV 5770SER08, or LV 5770SER09A	
VECT	LV 5770SER03A, LV 5770SER08, or LV 5770SER09A	HD tri-level sync signal input is not supported.
PIC	LV 5770SER03A, LV 5770SER08, or LV 5770SER09A	HD tri-level sync signal input is not supported.
AUDIO	LV 5770SER41 or LV 5770SER43	
STATUS	LV 5770SER03A, LV 5770SER08, or LV 5770SER09A	Simul mode is not supported.
EYE	LV 5770SER09A	Simul mode is not supported.

## 5. BASIC OPERATING PROCEDURES

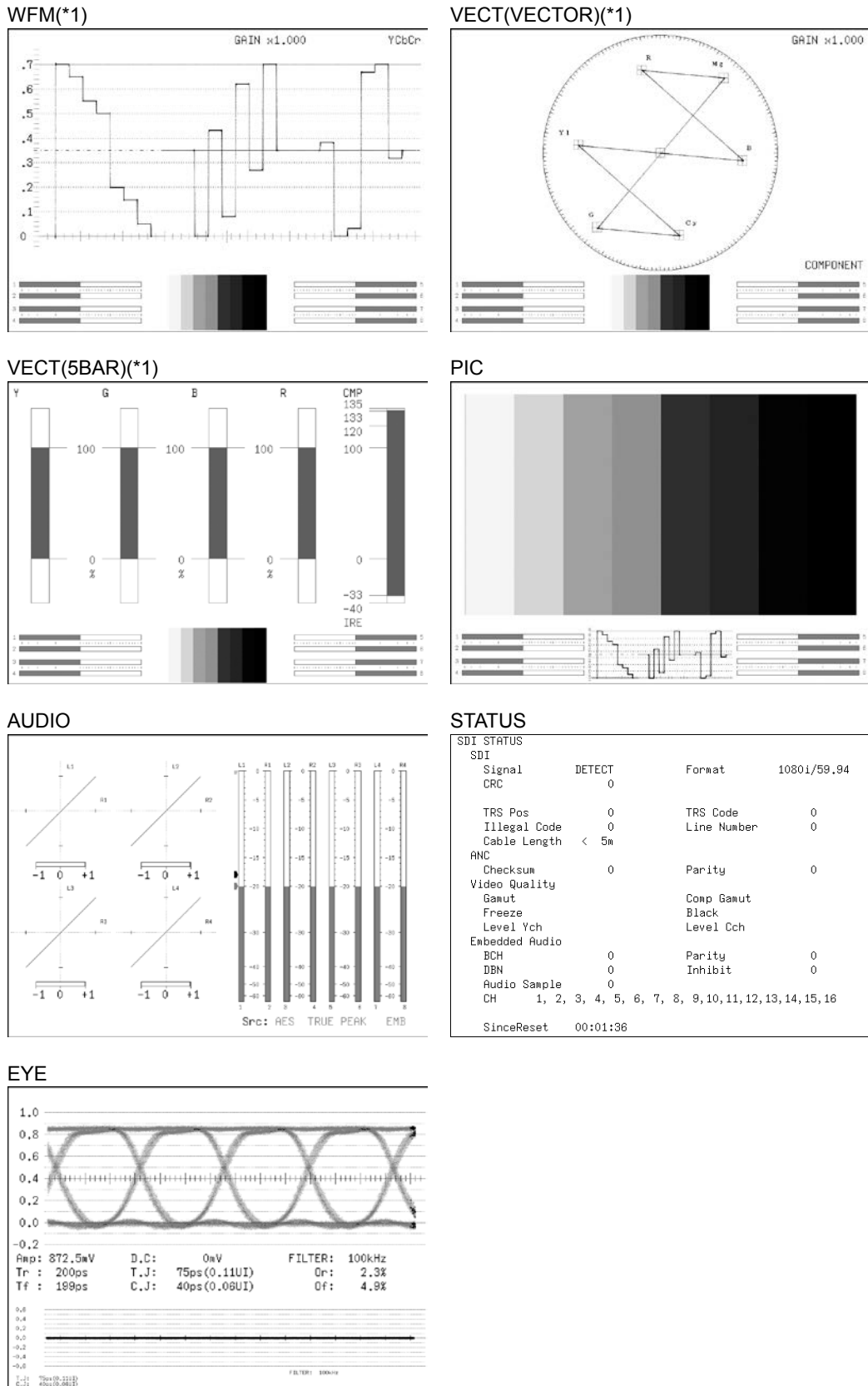

Figure 5-7 Selecting the display mode

\*1 The audio meter is not displayed if an LV 5770SER41 or LV 5770SER43 is not installed in the LV 5770A.

## 6. DETAILED MEASUREMENT EXAMPLES

This chapter explains detailed measurement examples. For the basic operating procedures, see chapter 5, “BASIC OPERATING PROCEDURES.”

Initialize the LV 5770A immediately before you perform the operating procedures shown here. See section 7.7, “Initializing Settings.”

### 6.1 SDI Signal Measurement

- **Required Optional Unit**

LV 5770SER08(SDI INPUT) or LV 5770SER09A(SDI INPUT/EYE)

- 1. Apply an SDI signal to SDI INPUT A or SDI INPUT B on the rear panel.**

The SDI signal is displayed.

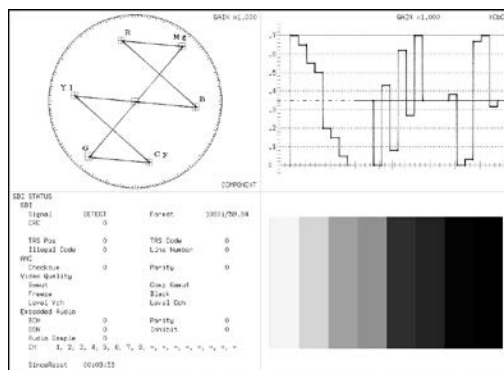

Figure 6-1 SDI signal measurement

## 6.2 SDI Signal Eye Pattern Measurement

- **Required Optional Unit**  
LV 5770SER09A(SDI INPUT/EYE)

1. **Apply an SDI signal to SDI INPUT A or SDI INPUT B on the rear panel.**
2. **Turn the MULTI key off (optional).**

The LV 5770A switches to the 1-screen display, which is easier to view. (On the multi-screen display, one of these displays is shown.) This is not supported in simul mode or on the multi-screen display of 3G-B(2map) signals.

3. **Press EYE.**

The eye pattern and jitter waveforms are displayed. Simul mode is not supported.

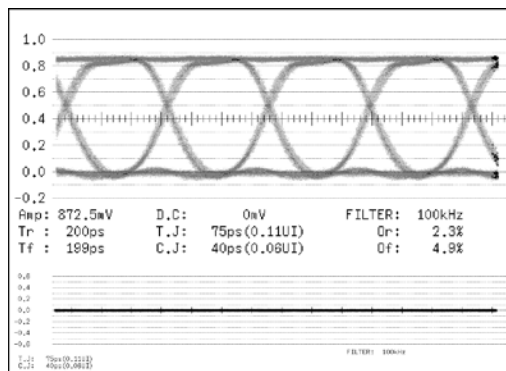

Figure 6-2 SDI signal eye pattern measurement

## 6.3 Composite Signal Measurement

- **Required Optional Unit**  
LV 5770SER03A(TRI SYNC/COMPOSITE)

1. **Apply a composite signal or an HD tri-level sync signal to the TRI SYNC/COMPOSITE INPUT A connector or TRI SYNC/COMPOSITE INPUT B connector on the rear panel.**
2. **Press CMPST.**

The composite signal or HD tri-level sync signal is displayed. When an HD tri-level sync signal is applied, the vector waveform and picture are not displayed.

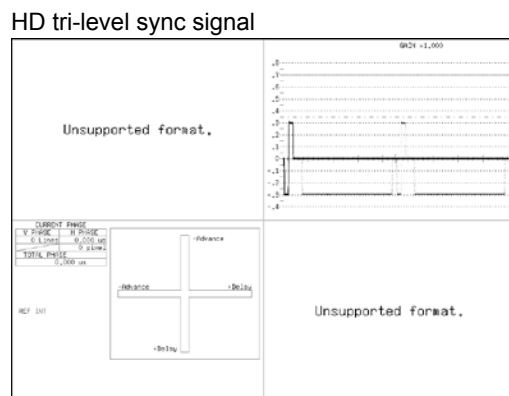
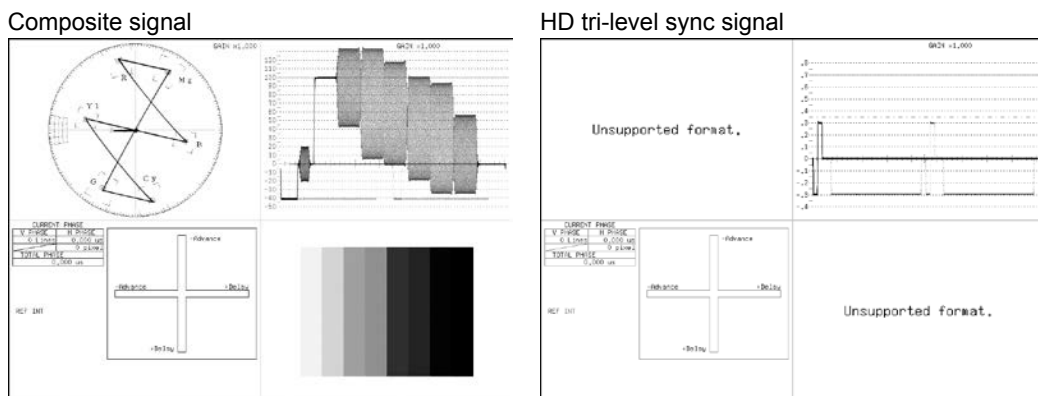

Figure 6-3 Composite signal measurement

## 6.4 Embedded Audio Signal Measurement

You can measure two of the following groups—for a total of eight channels—of the audio signals embedded in an SDI signal.

(With the LV 5770SER43, you can measure all four groups simultaneously.)

- Group 1 (channels 1 to 4)
  - Group 2 (channels 5 to 8)
  - Group 3 (channels 9 to 12)
  - Group 4 (channels 13 to 16)
- **Required Optional Units**
    - LV 5770SER41(DIGITAL AUDIO) or LV 5770SER43(DIGITAL AUDIO)
    - LV 5770SER08(SDI INPUT) or LV 5770SER09A(SDI INPUT/EYE)

**1. Apply an SDI signal to SDI INPUT A or SDI INPUT B on the rear panel.**

**2. Turn the MULTI key off (optional).**

The LV 5770A switches to the 1-screen display, which is easier to view.

**3. Press AUDIO.**

**4. Press **F•1** SOURCE SELECT and then **F•2** 1ST GRP SELECT or **F•3** 2ND GRP SELECT to select the measurement group.**

The embedded audio signals of the selected group are displayed.

“EMB” is displayed in the lower right of the screen to indicate that embedded audio signals are being measured.

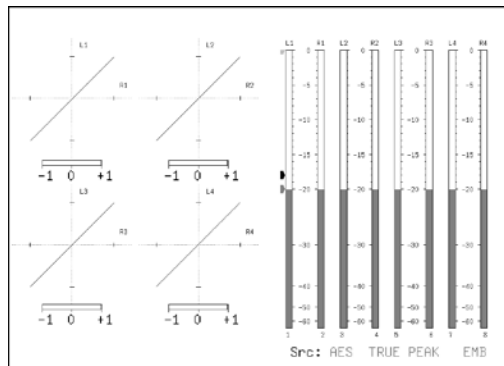

Figure 6-4 Embedded audio signal measurement



## 6.5 External Digital Audio Signal Measurement

You can measure group A (channels 1 to 8) or group B (channels 1 to 8)—for a total of eight channels—of the audio signals being applied to the rear panel.

(With the LV 5770SER43, you can measure both groups simultaneously.)

Simul mode is not supported. Perform this measurement with the SIM key LED turned off.

- **Required Optional Unit**

LV 5770SER41(DIGITAL AUDIO) or LV 5770SER43(DIGITAL AUDIO)

- 1. Apply digital audio signals to the group A and group B DIGITAL AUDIO IN/OUT connectors on the rear panel.**

Check that the Audio BNC settings are set to INPUT on the REAR PANEL SETUP tab in the system settings. These settings are set to INPUT when the LV 5770A is initialized.

See section 7.1.2, “Rear Panel Settings.”

- 2. Turn the MULTI key off (optional).**

The LV 5770A switches to the 1-screen display, which is easier to view.

- 3. Press AUDIO.**

- 4. Press F•1 SOURCE SELECT and then F•1 INPUT SELECT to select EXT DIGI.**

- 5. Press F•2 CHANNEL SELECT to select the measurement group.**

The external digital audio signals of the selected group are displayed.

“AES” is displayed in the lower right of the screen to indicate that external digital audio signals are being measured.

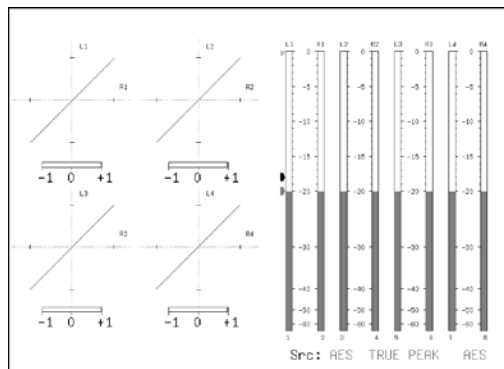

Figure 6-5 External digital audio signal measurement

## 6.6 Analog Audio Signal Measurement

You can measure the eight channels of analog audio signals that are applied to the rear panel connector.

Simul mode is not supported. Perform this measurement with the SIM key LED turned off.

- **Required Optional Unit**

- LV 5770SER41(DIGITAL AUDIO) or LV 5770SER43(DIGITAL AUDIO)
- LV 5770SER42(ANALOG AUDIO)

- 1. Apply analog audio signals to the ANALOG AUDIO connector on the rear panel.**

Check that the ANALOG AUDIO setting is set to INPUT on the REAR PANEL SETUP tab in the system settings. This setting is set to INPUT when the LV 5770A is initialized.

See sections 4.4.7, “Analog Audio Signal I/O (LV 5770SER42)” and 7.1.2, “Rear Panel Settings.”

- 2. Turn the MULTI key off (optional).**

The LV 5770A switches to the 1-screen display, which is easier to view.

- 3. Press AUDIO.**

- 4. Press **F•1** SOURCE SELECT and then **F•1** INPUT SELECT to select EXT ANA.**

The eight channels of audio signals are displayed.

“ANA” is displayed in the lower right of the screen to indicate that analog audio signals are being measured.

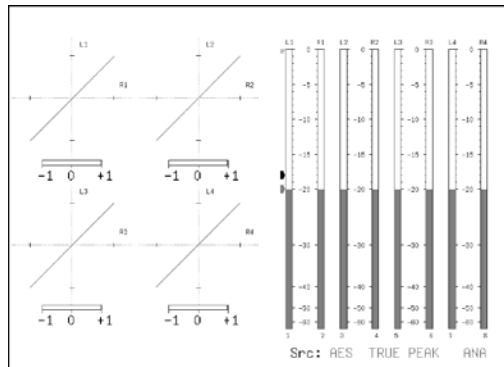

Figure 6-6 Analog audio signal measurement

## 6.7 Embedded Audio Signal Output

You can generate channels 1 to 16 of an audio signal that is embedded in an SDI signal from the rear panel DIGITAL AUDIO IN/OUT connectors. Group A generates channels 1 to 8, and group B generates channels 9 to 16.

- **Required Optional Unit**

- LV 5770SER41(DIGITAL AUDIO) or LV 5770SER43(DIGITAL AUDIO)
- LV 5770SER08(SDI INPUT) or LV 5770SER09A(SDI INPUT/EYE)

**1. Apply an SDI signal to SDI INPUT A or SDI INPUT B on the rear panel.**

**2. Press SYS.**

**3. Press **F•1** FORMAT IN OUT and then **F•3** NEXT TAB. Set GROUP A and GROUP B to OUTPUT and GROUP A OUT SEL and GROUP B OUT SEL to SDI.**

Check that no signals are being applied to the DIGITAL AUDIO IN/OUT connectors on the rear panel.

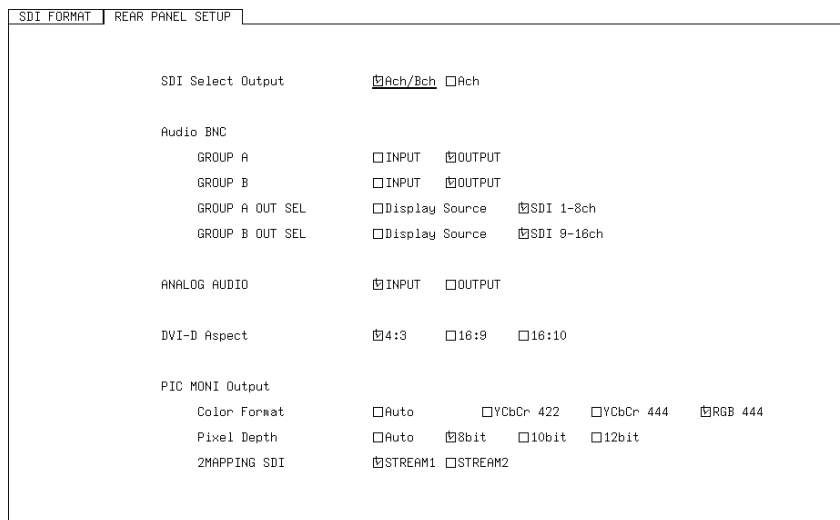

Figure 6-7 REAR PANEL SETUP tab

**4. Press **F•1** COMPLETE.**

Channels 1 to 16 of the embedded audio signal are generated.

- **Explanation of “Display Source”**

If you select Display Source on the REAR PANEL SETUP screen, the eight channels of audio signals that are currently being measured will be generated.

For details about the output signals during 16-channel measurement, see section 7.1.2, “Rear Panel Settings.”

## 6.8 Analog Audio Signal Output

You can perform a D/A conversion on and generate up to eight channels of embedded audio signals or external digital audio signals as analog audio signals from the rear panel ANALOG AUDIO connector.

This section will show the procedure for generating embedded audio signals.

- **Required Optional Unit**

- LV 5770SER41(DIGITAL AUDIO) or LV 5770SER43(DIGITAL AUDIO)
- LV 5770SER42(ANALOG AUDIO)
- LV 5770SER08(SDI INPUT) or LV 5770SER09A(SDI INPUT/EYE)  
(This is not required if you want to generate external digital audio signals.)

1. **Apply an SDI signal to SDI INPUT A or SDI INPUT B on the rear panel.**
2. **Press SYS.**
3. **Press **F•1** FORMAT IN OUT and then **F•3** NEXT TAB. Set ANALOG AUDIO to OUTPUT.**

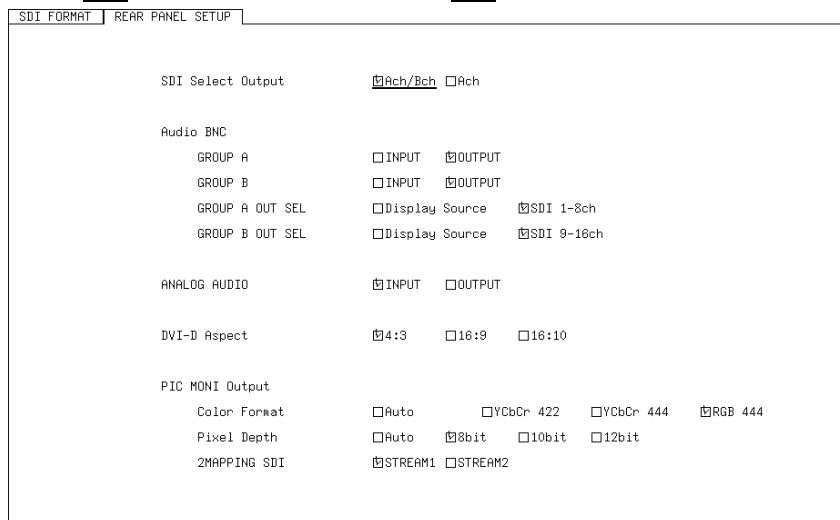

Figure 6-8 REAR PANEL SETUP tab

4. **Press **F•1** COMPLETE.**
5. **Press AUDIO.**
6. **Press **F•1** SOURCE SELECT and then **F•2** 1ST GRP SELECT or **F•3** 2ND GRP SELECT to select the measurement group.**

The eight channels of the embedded audio signal of the selected group are generated. For details about the output signals during 16-channel measurement, see section 7.1.2, "Rear Panel Settings."

## 7. SYSTEM SETTINGS

You can use the system menu to configure LV 5770A settings and optional unit settings. To display the system menu, press SYS.

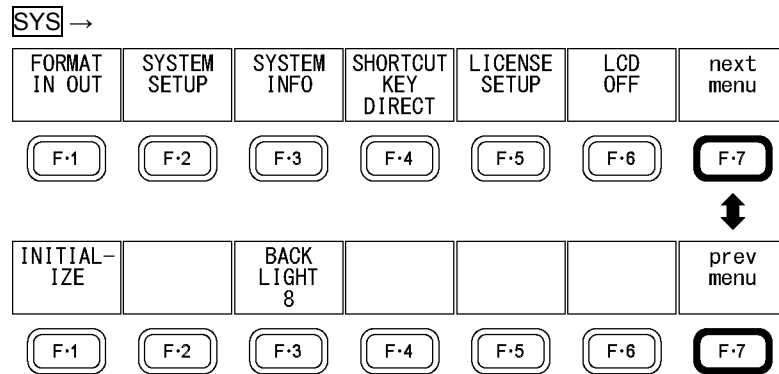

Figure 7-1 System menu

7.1 I/O Settings

To configure the I/O settings, press **F•1** FORMAT IN OUT on the system menu. FORMAT IN OUT is a tab menu. For details on how to operate tab menus, see section 4.6.3, “Tab Menu Operations.”

7.1.1 Configuring SDI Input Settings (LV 5770SER08 and LV 5770SER09A)

Use the SDI FORMAT tab to configure the input SDI signal format.

**SYS** → **F•1** FORMAT IN OUT →

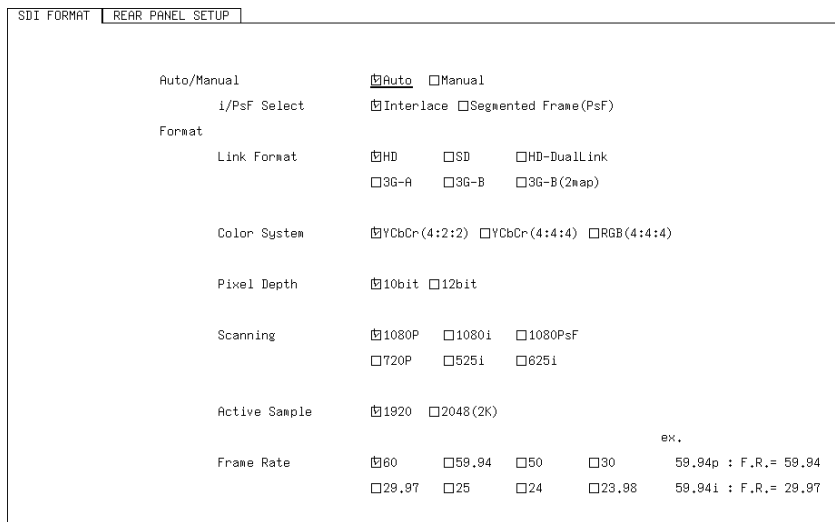

Figure 7-2 SDI FORMAT tab

● **Auto/Manual**

Select whether the input signal format will be detected automatically.

If you select Auto, the payload ID packet must be correctly embedded in the input signal for the LV 5770A to detect a 3G or HD dual link signal.

---

Auto / Manual

---

● **i/PsF Select**

When Auto/Manual is set to Auto, set the display format for the following input formats to interlace or segmented frame.

- 1080i/60 and 1080PsF/30
- 1080i/59.94 and 1080PsF/29.97
- 1080i/50 and 1080PsF/25

---

Interlace / Segmented Frame(PsF)

---

## 7. SYSTEM SETTINGS

- **Format**

When Auto/Manual is set to Manual, select the input format.

The combinations shown below are the formats that you can select. If you specify a format that is not one of the following combinations, "ILLEGAL FORMAT" will be displayed. Specify a correct format.

It may take the LV 5770A approximately 10 seconds to switch to a different format.

Table 7-1 Input format settings

Link Format	Color System	Pixel Depth	Scanning	Active Sample	Frame Rate (*1)
HD	YCbCr(4:2:2)	10bit	1080P	1920	30/29.97/25/24/23.98
			1080i	1920	30/29.97/25
			1080PsF	1920	30/29.97/25/24/23.98
			720P	1920	60/59.94/50/ 30/29.97/25/24/23.98
SD	YCbCr(4:2:2)	10bit	525i	-	29.97
			625i	-	25
HD-DualLink	YCbCr(4:2:2)	10bit	1080P	1920	60/59.94/50
			1080i	1920	30/29.97/25
		12bit	1080P	1920	30/29.97/25/24/23.98
			1080PsF	1920	30/29.97/25/24/23.98
	YCbCr(4:4:4)	10bit	1080P	1920	30/29.97/25/24/23.98
			1080i	1920	30/29.97/25
			1080PsF	1920	30/29.97/25/24/23.98
		12bit	1080P	1920	30/29.97/25/24/23.98
			1080i	1920	30/29.97/25
			1080PsF	1920	30/29.97/25/24/23.98
	RGB(4:4:4)	10bit	1080P	1920	30/29.97/25/24/23.98
			1080i	1920	30/29.97/25
			1080PsF	1920	30/29.97/25/24/23.98
			1080P	2048(2K)	24/23.98
		12bit	1080P	1920	30/29.97/25/24/23.98
			1080i	1920	30/29.97/25
1080PsF			1920	30/29.97/25/24/23.98	
1080PsF			2048(2K)	24/23.98	

7. SYSTEM SETTINGS

Link Format	Color System	Pixel Depth	Scanning	Active Sample	Frame Rate (*1)
3G-A	YCbCr(4:2:2)	10bit	1080P	1920	60/59.94/50
			1080i	1920	30/29.97/25
		12bit	1080P	1920	30/29.97/25/24/23.98
			1080PsF	1920	30/29.97/25/24/23.98
	YCbCr(4:4:4)	10bit	1080P	1920	30/29.97/25/24/23.98
			1080i	1920	30/29.97/25
			1080PsF	1920	30/29.97/25/24/23.98
			720P	1920	60/59.94/50/ 30/29.97/25/24/23.98
		12bit	1080P	1920	30/29.97/25/24/23.98
			1080i	1920	30/29.97/25
			1080PsF	1920	30/29.97/25/24/23.98
			1080PsF	1920	30/29.97/25/24/23.98
	RGB(4:4:4)	10bit	1080P	1920	30/29.97/25/24/23.98
			1080i	1920	30/29.97/25
			1080PsF	1920	30/29.97/25/24/23.98
			720P	1920	60/59.94/50/ 30/29.97/25/24/23.98
		12bit	1080P	1920	30/29.97/25/24/23.98
			1080i	1920	30/29.97/25
			1080PsF	1920	30/29.97/25/24/23.98
			1080PsF	2048(2K)	24/23.98
3G-B	YCbCr(4:2:2)	10bit	1080P	1920	60/59.94/50
			1080i	1920	30/29.97/25
		12bit	1080P	1920	30/29.97/25/24/23.98
			1080PsF	1920	30/29.97/25/24/23.98
	YCbCr(4:4:4)	10bit	1080P	1920	30/29.97/25/24/23.98
			1080i	1920	30/29.97/25
			1080PsF	1920	30/29.97/25/24/23.98
		12bit	1080P	1920	30/29.97/25/24/23.98
			1080i	1920	30/29.97/25
			1080PsF	1920	30/29.97/25/24/23.98
	RGB(4:4:4)	10bit	1080P	1920	30/29.97/25/24/23.98
			1080i	1920	30/29.97/25
			1080PsF	1920	30/29.97/25/24/23.98
			1080PsF	1920	30/29.97/25/24/23.98
		12bit	1080P	1920	30/29.97/25/24/23.98
			1080i	1920	30/29.97/25
			1080PsF	1920	30/29.97/25/24/23.98
			1080PsF	2048(2K)	24/23.98



## 7. SYSTEM SETTINGS

Link Format	Color System	Pixel Depth	Scanning	Active Sample	Frame Rate (*1)
3G-B(2map)	YCbCr(4:2:2)	10bit	1080P	1920	30/29.97/25/24/23.98
			1080i	1920	30/29.97/25
			1080PsF	1920	30/29.97/25/24/23.98
			720P	1920	60/59.94/50/ 30/29.97/25/24/23.98

\*1 Note that when i/PsF Select is set to Interlace, the frame rate is displayed. For example, if the field rate is 59.94 Hz, set the frame rate to 29.97.

### 7.1.2 Rear Panel Settings

Use the REAR PANEL SETUP tab to configure the rear panel I/O connector settings.

**SYS** → **F•1** FORMAT IN OUT → **F•3** NEXT TAB →

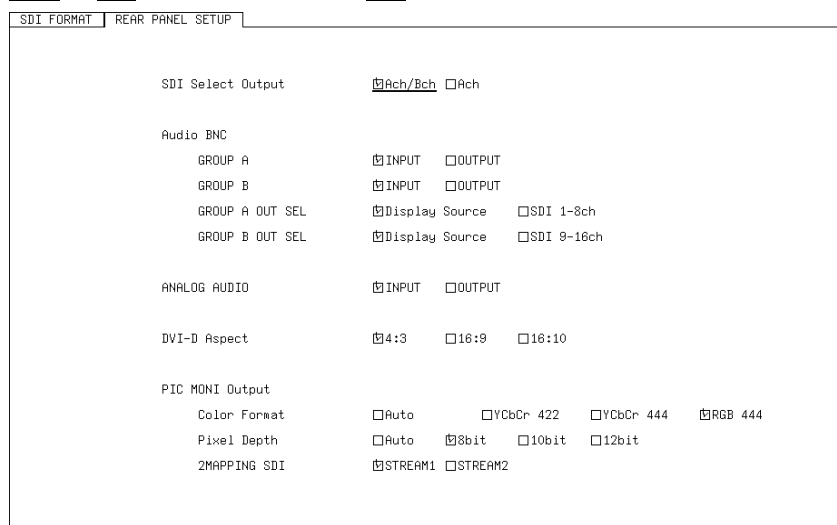

Figure 7-3 REAR PANEL SETUP tab

- **SDI Select Output (LV 5770SER08 and LV 5770SER09A)**

Select the signal that is generated from SDI OUTPUT A/B. For HD dual link signals, the signal that is generated is fixed to link A, regardless of this setting.

---

**Ach/Bch:** The SDI OUTPUT A/B connector transmits the reclocked version of the signal that has been received by the connector, either SDI INPUT A or SDI INPUT B, that you choose by pressing the A or B key.

**Ach:** The SDI OUTPUT A/B connector transmits the reclocked version of the signal that has been received by the SDI INPUT A connector.

---

- **GROUP A and GROUP B (LV 5770SER41 and LV 5770SER43)**

Select whether the DIGITAL AUDIO connectors of each group will be used as input connectors or output connectors. When you set a group to function as output connectors, do not apply audio signals to the connectors in the group.

---

**INPUT / OUTPUT**

---

- **GROUP A OUT SEL and GROUP B OUT SEL (LV 5770SER41 and LV 5770SER43)**

When GROUP A or GROUP B is set to OUTPUT, select the corresponding output signal.

The LV 5770SER08 or LV 5770SER09A is required to generate embedded audio signals.

---

<u>Display Source:</u>	The eight channels of audio signals that are currently being measured will be generated.
SDI 1-8ch:	Channels 1 to 8 of the embedded audio will be generated.
SDI 9-16ch:	Channels 9 to 16 of the embedded audio will be generated.

---

The output signals when you select Display Source during 16-channel measurement are shown below. (LV 5770SER43)

Table 7-2 Output signals during 16-channel measurement

INPUT SELECT	DECODE MODE	MIX MODE	Group A Output	Group B Output
SDI	OFF	-	Channels 1 to 8	Channels 9 to 16
	DOLBY E / DOLBY D	ON	Channels D1 to D8	Channels 1 to 16 (*1)
EXT DIGI	DOLBY E / DOLBY D	ON	Channels D1 to D8	-(INPUT)
			-(INPUT)	Channels D1 to D8

\*1 Outputs the eight channels selected with 1ST GRP PCM and 2ND GRP PCM.

- **ANALOG AUDIO (LV 5770SER42)**

Select whether to enable the input pins or the output pins of the ANALOG AUDIO connector. The pins that you do not select will be disabled.

---

<u>INPUT:</u>	The input pins are enabled.
<u>OUTPUT:</u>	The output pins are enabled. The eight channels of audio signals that are currently being measured will be generated.

---

The output signals when you select OUTPUT during 16-channel measurement are shown below. (LV 5770SER43)

Table 7-3 Output signals during 16-channel measurement

INPUT SELECT	DECODE MODE	MIX MODE	Analog Output
SDI	OFF	-	Channels 1 to 8
	DOLBY E / DOLBY D	ON	Channels D1 to D8
EXT DIGI	OFF	-	Channels A1 to A8
	DOLBY E / DOLBY D	ON	Channels D1 to D8

- **DVI-D Aspect**

Select the aspect ratio of the display that you are using. To hide pillarboxing, change the aspect ratio.

---

4:3 / 16:9 / 16:10

---

## 7. SYSTEM SETTINGS

- **Color Format (LV 5770SER08 and LV 5770SER09A)**

Select the picture monitor output format.

If you select Auto, the signal is generated in the same format as the input signal.

---

Auto / YCbCr 422 / YCbCr 444 / RGB 444

---

- **Pixel Depth (LV 5770SER08 and LV 5770SER09A)**

Select the quantization of picture monitor output.

If you select Auto, the signal is generated in the same quantization as the input signal.

---

Auto / 8bit / 10bit / 12bit

---

- **2MAPPING SDI (LV 5770SER08 and LV 5770SER09A)**

When the input signal is 3G-B(2map), select the picture monitor output signal.

---

STREAM1 / STREAM2

---

## 7.2 Configuring the LV 5770A

To configure the LV 5770A, press **F•2** SYSTEM SETUP on the system menu. SYSTEM SETUP is a tab menu. For details on how to operate tab menus, see section 4.6.3, “Tab Menu Operations.”

### 7.2.1 General Settings

Use the GENERAL SETUP tab to configure general LV 5770A settings.

**SYS** → **F•2** SYSTEM SETUP →

GENERAL SETUP	ETHERNET SETUP	REMOTE SETUP	DATE&TIME
GENERAL SETUP			
Multi Display	<input type="checkbox"/> 2Multi	<input checked="" type="checkbox"/> 4Multi	
Capture Mode	<input checked="" type="checkbox"/> Screen	<input type="checkbox"/> Video Frame(SDI Only)	
Memory Store Mode	<input type="checkbox"/> Loudness 2h	<input checked="" type="checkbox"/> Loudness 32h (No TIF/DPX Frame Capture)	
Information Display			
Format	<input checked="" type="checkbox"/> ON	<input type="checkbox"/> OFF	
Date	<input type="checkbox"/> OFF	<input checked="" type="checkbox"/> y/m/d	<input type="checkbox"/> m/d/y <input type="checkbox"/> d/m/y
Time	<input type="checkbox"/> OFF	<input checked="" type="checkbox"/> Real Time	<input type="checkbox"/> LTC <input type="checkbox"/> VITC <input type="checkbox"/> D-VITC
Color System	<input checked="" type="checkbox"/> ON	<input type="checkbox"/> OFF	
Input	<input checked="" type="checkbox"/> ON	<input type="checkbox"/> OFF	
LCD Setup			
Auto Off	<input checked="" type="checkbox"/> OFF	<input type="checkbox"/> 5min	<input type="checkbox"/> 30min <input type="checkbox"/> 60min
MENU Setup			
Auto Off	<input type="checkbox"/> OFF	<input checked="" type="checkbox"/> ON	
Time	<input type="text" value="5"/>	sec(1-60)	

Figure 7-4 GENERAL SETUP tab

- **Multi Display**

Select the number of screens that are displayed when the MULTI key LED is lit.  
See section 5.1, “Selecting the Display Format”

---

2Multi / 4Multi

---

- **Capture Mode (LV 5770SER08 and LV 5770SER09A)**

Select the capture mode for when you press CAP.  
See chapter 8, “CAPTURE FEATURE”

---

<u>Screen:</u>	The screen will be captured as still images.
<u>Video Frame(SDI Only):</u>	Single frames of data will be captured. This requires the LV 5770SER08 or LV 5770SER09A.

---

- **Memory Store Mode (option)**

This setting appears when you set Capture Mode to Video Frame, and press **F•1** COMPLETE and then **F•2** SYSTEM SETUP. Set the maximum duration of loudness measurements.

---

<u>Loudness 2h</u> :	Up to 2 hours of loudness measurements can be performed.
Loudness 32h:	Up to 32 hours of loudness measurements can be performed. Captured frame data cannot be saved in TIF or DPX format.

---

- **Format (LV 5770SER03A, LV 5770SER08, and LV 5770SER09A)**

Turn the format indication (for example, 1080i/59.94 or NTSC) that is shown at the top of the screen on or off.

ON / OFF

---

- **Date**

Select the display format for the date that is shown in the upper left of the screen.  
y = the year in the Gregorian calendar, m = the month, d = the day

OFF / y/m/d / m/d/y / d/m/y

---

- **Time**

Select the display format for the time that is shown at the top of the screen.

---

OFF:	The time is not displayed.
<u>Real Time</u> :	The time that is set on the DATE&TIME tab is displayed.
LTC:	The time that is set on the DATE&TIME tab and an LTC timecode are displayed.
VITC:	The time that is set on the DATE&TIME tab and a VITC timecode are displayed.
D-VITC:	The time that is set on the DATE&TIME tab and a D-VITC timecode (SD) are displayed.

---

- **Color System (LV 5770SER08 and LV 5770SER09A)**

Turn the SDI color system indication (for example, YCbCr(422)) that is shown at the top of the screen on or off.

ON / OFF

---

- **Input (LV 5770SER03A, LV 5770SER08, and LV 5770SER09A)**

Turn the input signal indication (for example, SDI-A or DUAL) that is shown at the top of the screen on or off.

ON / OFF

---

## 7. SYSTEM SETTINGS

- **Auto Off**

Select the length of time that must elapse without any key operations for the backlight to turn off automatically.

To turn it on again, press any key excluding the power switch.

---

OFF / 5min / 30min / 60min

---

- **Auto Off**

Select whether to make the function menu automatically disappear.

---

**OFF:** The menu does not disappear automatically. To clear the menu temporarily, for example in the measurement menu, press a key from 1 to 4, MODE, and then the SHORT key assigned to MENU OFF.

**ON:** The menu disappears automatically when the time specified by Time elapses after the last key operation. Some menus, such as the system menu, do not automatically disappear.

---

- **Time**

When Auto Off is set to ON, select the length of time that must elapse without any key operations for the menu to disappear automatically.

---

1 - 5 - 60 sec

---

## 7.2.2 Configuring Ethernet Settings

Configure the Ethernet settings on the ETHERNET SETUP tab.

The settings that you specify here will not be initialized even if you initialize the LV 5770A. In addition, they are not registered to presets.

See chapter 11, "ETHERNET REMOTE CONTROL."

**SYS** → **F•2** SYSTEM SETUP → **F•3** NEXT TAB →

GENERAL SETUP	ETHERNET SETUP	REMOTE SETUP	DATE&TIME
Ethernet Select		<input type="checkbox"/> DHCP <input checked="" type="checkbox"/> IP	
TCP / IP			
IP Address	<input type="text" value="192"/>	<input type="text" value="168"/>	<input type="text" value="0"/> <input type="text" value="1"/>
Subnet Mask	<input type="text" value="255"/>	<input type="text" value="255"/>	<input type="text" value="255"/> <input type="text" value="0"/>
Default Gateway	<input type="text" value="0"/>	<input type="text" value="0"/>	<input type="text" value="0"/> <input type="text" value="0"/>
SNTP Client Select		<input checked="" type="checkbox"/> OFF <input type="checkbox"/> ON	
Server IP Address	<input type="text" value="0"/>	<input type="text" value="0"/>	<input type="text" value="0"/> <input type="text" value="0"/>
Time Zone Adjust	<input type="text" value="+"/>	<input type="text" value="9"/>	<input type="text" value="0"/> [ +/- hour : minutes ]
TELNET Server Select	<input checked="" type="checkbox"/> OFF <input type="checkbox"/> ON	<input type="checkbox"/> LV7770-01	
FTP Server Select	<input checked="" type="checkbox"/> OFF <input type="checkbox"/> ON		
HTTP Server Select	<input checked="" type="checkbox"/> OFF <input type="checkbox"/> ON		
SNMP READ	<input checked="" type="checkbox"/> OFF <input type="checkbox"/> ONLY <input type="checkbox"/> WRITE		
SNMP TRAP	<input checked="" type="checkbox"/> OFF <input type="checkbox"/> ON		
NETWORK MODE	<input type="checkbox"/> LV5770 <input checked="" type="checkbox"/> LV5770A		
			MAC ADDRESS: 00:00:00:00:00:00

Figure 7-5 ETHERNET SETUP tab

- **Ethernet Select**

Select how to set the IP address.

This setting is enabled after you restart the LV 5770A.

---

**DHCP:** The IP address, subnet mask, and default gateway are set automatically.

**IP:** Set the IP address, subnet mask, and default gateway manually.

---

- **SNTP Client Select**

Select whether to enable the SNTP client feature.

When set to ON, Server IP Address is set to the IP address of the NTP server, and Time Zone Adjust is set to the appropriate clock adjustment value.

---

OFF / ON

---

- **TELNET Server Select**

Select whether to enable the TELNET server feature and the LV 7770-01 (REMOTE CONTROLLER). You cannot use TELNET and the LV 7770-01 at the same time.

---

OFF / ON / LV7770-01

---

## 7. SYSTEM SETTINGS

- **FTP Server Select**

Select whether to enable the FTP server feature.

---

OFF / ON

---

- **HTTP Server Select**

Select whether to enable the HTTP server feature.

---

OFF / ON

---

- **SNMP READ**

Select the SNMP access mode.

---

OFF: SNMP cannot be used.  
 ONLY: Settings can be read.  
 WRITE: Settings can be read and written.

---

- **SNMP TRAP**

Select whether to enable SNMP trap output.

---

OFF / ON

---

- **NETWORK MODE**

Select the TELNET, FTP, and SNMP operation mode.  
 This setting is enabled after you restart the LV 5770A.

---

LV5770: LV 5770 mode is used. Select this when you want to use TELNET, FTP, and SNMP with the same conditions as the LV 5770.  
LV5770A: LV 5770A mode is used. Normally, select this mode.

---

Table 7-4 Operation mode description

		LV 5770	LV 5770A
TELNET	Login name, password	LV5770	LV5770A
	Prompt	LV5770>	LV5770A>
FTP	Login name, password	LV5770	LV5770A
SNMP	MIB file	lv5770a_org.my (*1)	lv5770a.my
	MIB prefix	I21	I33

\*1 The LV 5770 MIB file (lv5770.my) can also be used, but the backlight setting (I21sysGeneralLcdBacklight) is invalid.

- **MAC ADDRESS**

Displays the MAC address of the LV 5770A.



## 7.2.3 Remote Control Settings

Use the REMOTE SETUP tab to configure remote control settings.

The settings that you specify here will not be initialized even if you initialize the LV 5770A. In addition, they are not registered to presets.

See chapter 10, "REMOTE CONTROL."

**SYS** → **F•2** SYSTEM SETUP → **F•3** NEXT TAB → **F•3** NEXT TAB →

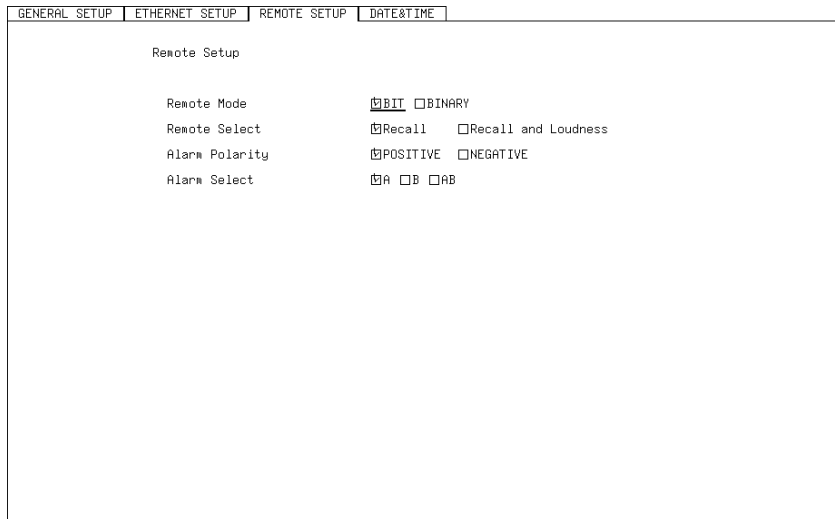

Figure 7-6 REMOTE SETUP tab

- **Remote Mode**

Select the method for loading presets.

---

<b>BIT:</b>	Use pin 2 (/P1) to pin 9 (/P8) to load presets 1 to 8. (when Remote Select is set to Recall) Use pin 2 (/P1) to pin 7 (/P6) to load presets 1 to 6. (when Remote Select is set to Recall and Loudness)
<b>BINARY:</b>	Set pin 2 (/P1) as the least significant bit and pin 7 (/P6) as the most significant bit, and use binary code to load presets 1 to 60.

---

- **Remote Select**

Select the function to assign to pin 8 (/P7) and pin 9 (/P8) of the remote control connector.

---

<b>Recall:</b>	Assign preset recalling.
<b>Recall and Loudness:</b>	Assign loudness measurement control.

---

- **Alarm Polarity**

Select the alarm output polarity.

---

<b>POSITIVE:</b>	A high signal is transmitted when an error is detected.
<b>NEGATIVE:</b>	A low signal is transmitted when an error is detected.

---

- **Alarm Select**

Select the channel that errors are detected on for transmitting alarms.

---

A / B / AB

---

#### 7.2.4 Setting the Date and Time

Use the DATE&TIME tab to set the date and time.

You cannot set the date and time when SNTP Client Select on the ETHERNET SETUP tab is set to ON. To set the date and time manually, set SNTP Client Select to OFF, and then press **F•1** COMPLETE. Then, press **F•2** SYSTEM SETUP again.

The settings that you specify here will not be initialized even if you initialize the LV 5770A. In addition, they are not registered to presets.

**SYS** → **F•2** SYSTEM SETUP → **F•2** PREV TAB →

GENERAL SETUP	ETHERNET SETUP	REMOTE SETUP	DATE&TIME
DATE ADJUST			
DAY			<input type="text" value="9"/>
MONTH			<input type="text" value="6"/>
YEAR			<input type="text" value="2011"/>
TIME ADJUST			
HOUR			<input type="text" value="9"/>
MINUTE			<input type="text" value="59"/>
SECOND			<input type="text" value="56"/>

Figure 7-7 DATE&TIME tab

### 7.3 Displaying System Information

To display the system information, press **F•3** SYSTEM INFO on the system menu. You can use this screen to view the LV 5770A firmware version and the types of installed optional units.

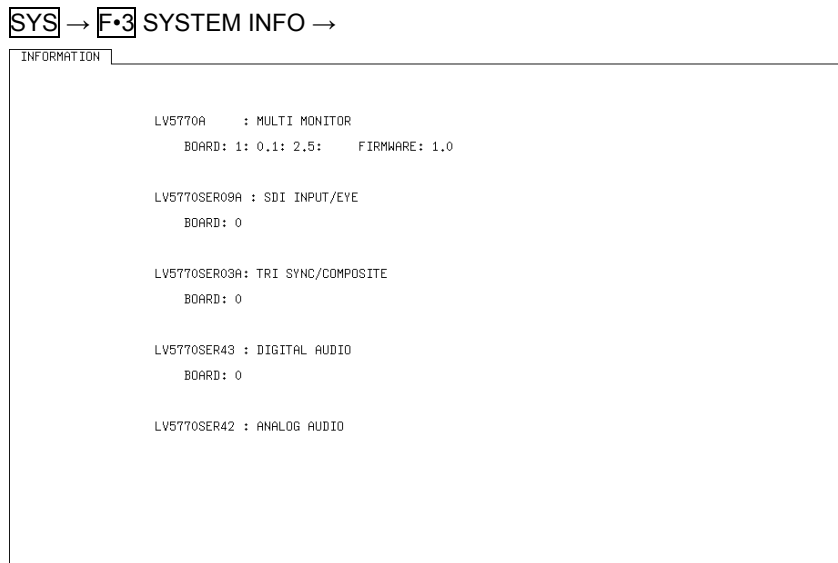

Figure 7-8 INFORMATION display

### 7.4 Setting the Shortcut Key

To set the shortcut key, press **F•4** SHORTCUT KEY on the system menu. The feature that you assign here will be performed when you press SHORT. See section 4.6.5, “Operating the Shortcut Key.”

#### Settings

- 
- DIRECT**: The previously registered panel settings will be loaded. To register the panel settings, configure the LV 5770A to the settings that you want to register, press MEM, and then press SHORT.
- VOLUME**: The headphone volume will be adjusted.
- CAP&WAIT**: A screen capture will be taken and saved to a USB memory device.
- INTEN**: The waveform intensity will be adjusted.
- MENU OFF**: The menu is cleared. You can select this when Auto Off under GENERAL SETUP in the system settings is set to OFF.
-

### 7.5 Configuring License Settings

To configure the license settings, press **F•5** LICENSE SETUP on the system menu. You can use this screen to view the MAC address and install options. For details on installing options, see the instruction manuals for the options.

**SYS** → **F•5** LICENSE SETUP →

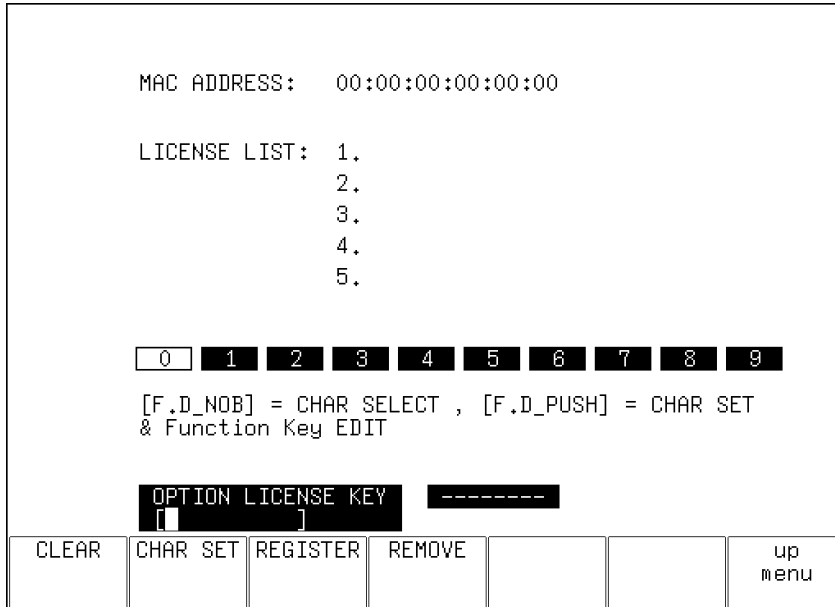

Figure 7-9 LICENSE SETUP display

### 7.6 Turning Off the LCD Panel

To turn off the LCD, press **F•6** LCD OFF on the system menu. To turn it on again, press any key excluding the power switch.

### 7.7 Initializing Settings

To initialize the settings, press **F•7** next menu → **F•1** INITIALIZE on the system menu. To proceed with the initialization, press **F•1** INIT YES. To cancel the initialization, press **F•3** INIT NO.

**SYS** → **F•7** next menu → **F•1** INITIALIZE →

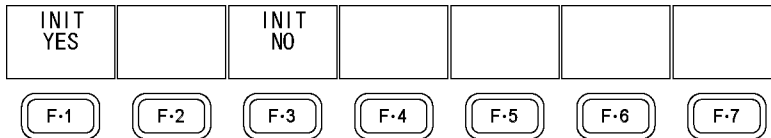

Figure 7-10 INITIALIZE menu

When you initialize the settings, all the settings—excluding those listed below—are initialized. For information about the default values, see chapter 12, “MENU TREES.” If you want to initialize the following settings as well, see the factory default settings in the following section.

- Ethernet settings (ETHERNET SETUP)
- Remote control settings (REMOTE SETUP)
- Date and time settings (DATE&TIME)
- Preset contents
- The panel settings that are registered to the SHORT key
- The CINELITE user-defined correction tables

- **Factory Default Settings**

To initialize all items other than the date and time, hold down the V POS and H POS knobs while you turn the power on. Press **F•1** YES when the following screen appears.

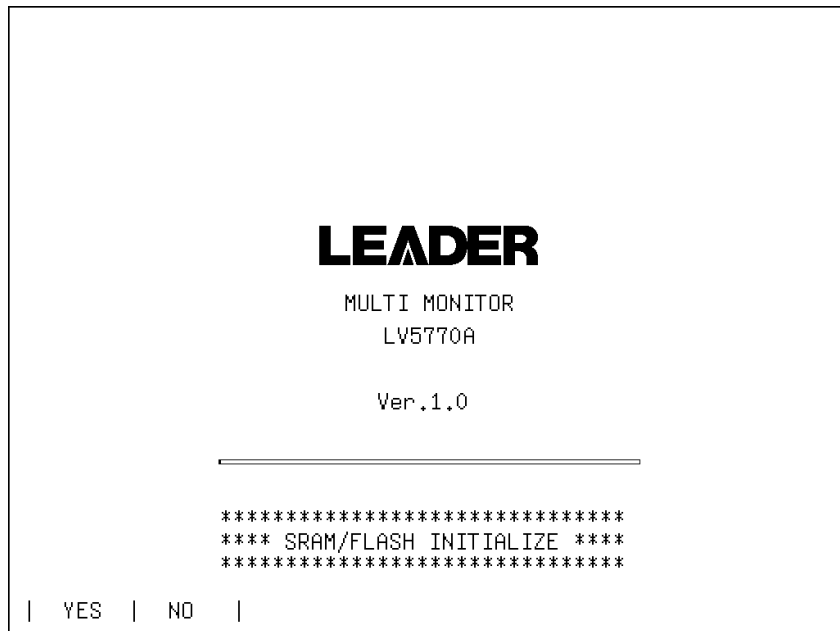

Figure 7-11 Factory default settings

## 7.8 Adjusting the Backlight

To adjust the backlight, on the system menu, press **F•7** next menu and then **F•3** BACK LIGHT. The larger the value, the brighter the backlight. Press the function dial (F•D) to return the setting to its default value (8).

## 8. CAPTURE FEATURE

The capture feature consists of screen capture and frame capture. Frame capture requires the LV 5770SER08 or LV 5770SER09A.

### • Screen Capture

You can use the screen capture feature to capture still-image data of the screen. You can save the captured data to USB memory or overlay it on the input signal on the LV 5770A display.

### • Frame Capture (LV 5770SER08 and LV 5770SER09A)

You can use the frame capture feature to capture single frames of data from the SDI signal. You can save the captured data to USB memory or overlay it on the input signal on the LV 5770A display.

Because data is captured as frame data, the data can be displayed on the LV 5770A in different display modes. The supported display modes are the video signal waveform, vector waveform, picture, and status (data dump) displays. For details on the data dump display, see the LV 5770SER08/LV 5770SER09A instruction manual.

### • Switching between Screen Capture and Frame Capture

Change the Capture Mode setting on the GENERAL SETUP display.

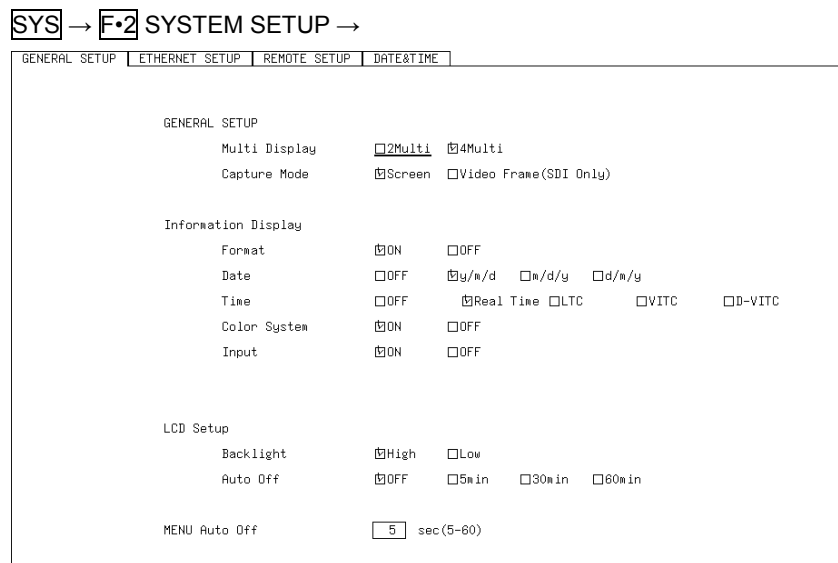

Figure 8-1 GENERAL SETUP tab

## 8.1 Screen Capture

### 8.1.1 Taking a Screen Capture of the Display

To take a screen capture of the display, follow the procedure below.

You cannot take screen captures of some screens such as tab menus and file lists.

1. **Configure the LV 5770A so that the display that you want to capture appears on the screen.**
2. **Press CAP.**

When you press CAP, the LV 5770A stores a screen capture of the display in its internal memory. You can also take screen captures by pressing **F•2** REFRESH while the capture menu is displayed.

Note that if you perform one of the following operations after capturing a display, the captured data will be cleared.

- Change the display mode.
- Press SDI, CMPST, SIM, SYS, a key from 1 to 4, MULTI, MEM, or RCLL.
- Turn off the power.

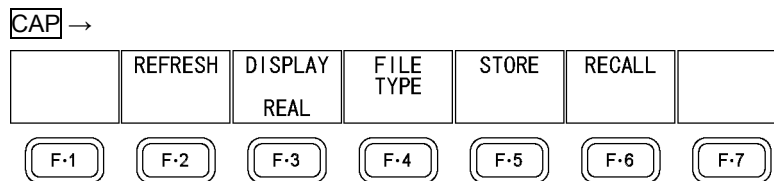

Figure 8-2 Capture menu

### 8.1.2 Displaying Screen Capture Data

If you press CAP, you can display the acquired screen capture data on the LV 5770A or overlay it on the current input signal.

You can display captured video signal waveform, vector, audio waveform, audio meter, eye pattern waveform, and picture display data on the LV 5770A. Other kinds of data (such as status and scale data) cannot be displayed. However, these other kinds of data can be saved to a USB memory device as BMP files.

To select the display mode, follow the procedure below.

#### Procedure

**CAP** → **F•3** DISPLAY: REAL / HOLD / BOTH

#### Settings

REAL:	The current input signal is displayed.
HOLD:	The screen capture data is displayed. The waveform is displayed in cyan.
BOTH:	The current input signal and the screen capture data are displayed on top of each other with their intensities halved.

## 8.1.3 Saving to a USB Memory Device

If you press CAP and perform an operation such as changing the display mode, the acquired screen capture data is deleted. However, by saving the screen capture data to a USB memory device in BSG format, you can display the screen capture data on the LV 5770A even after you restart the instrument.

Also, if you save the screen capture data in BMP format, you can view the captured data on a PC.

**1. Press F•4 FILE TYPE on the capture menu.**

The file format selection menu appears.

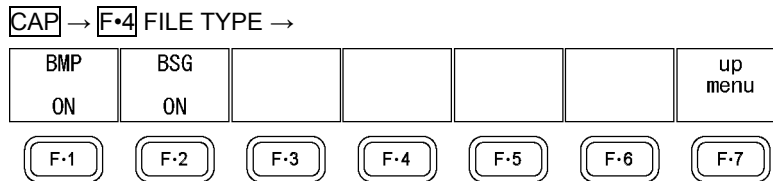

Figure 8-3 File format selection menu

**2. Select the file format.**

If you set F•1 BMP to ON, the screen capture data will be saved to the USB memory device as .bmp files. You can view the saved files on a PC.

If you set F•2 BSG to ON, the screen capture data will be saved to the USB memory device as .bsg files. You can view the saved files on the LV 5770A.

The default setting for both F•1 BMP and F•2 BSG is ON. You cannot set both of these settings to OFF.

**3. Press F•7 up menu.**

The capture menu appears.

**4. Press F•5 STORE.**

The message “Saving file - Please Wait.” is displayed on the screen, and the screen capture data is saved to the USB memory device.

This menu item appears when a USB memory device has been connected to the LV 5770A.

Regardless of the waveform color that you have specified, waveforms in the saved data are white.

It takes approximately 5 seconds to save a file, and the file size is approximately 2.4 MB for both .bmp and .bsg files.

The file is automatically assigned a name that consists of the year, month, day, hour, minute, and second (in that order) that are set in the system settings.

(Example: 20090501100859.bmp)



## 8. CAPTURE FEATURE

Screen capture data is saved to the following locations.

- └ USB memory device
  - └ LV5770A\_USER
    - └ BMP
      - └ yyyyymmddhhmmss.bmp
      - └ yyyyymmddhhmmss.bsg

### 8.1.4 Displaying Screen Capture Data Saved to a USB Memory Device

To display or overlay on the current input signal the screen capture data that has been saved to USB memory as .bsg files, follow the procedure below.

(Screen capture data that has been saved in BMP format and screen capture data that has been saved in BSG format on a different model cannot be displayed on the LV 5770A.)

**1. Press CAP.**

The capture menu appears.

**2. Press F•6 RECALL.**

The file list display appears.

This menu item appears when a USB memory device has been connected to the LV 5770A.

External USB FLASH DRIVE BitMap FILE LIST				
No.	File Name	Date	Time	Size(BYTE)
1	20110609132029.bsg	11/06/09	13:20	2,367,370
2	20110609132029.bmp	11/06/09	13:20	2,359,350
3	20110609132310.bsg	11/06/09	13:23	2,367,370
4	20110609132310.bmp	11/06/09	13:23	2,359,350

SIZE: 4,001,894,400byte  
FREE: 3,963,789,312byte

RECALL		DELETE FILE				up menu
--------	--	----------------	--	--	--	------------

Figure 8-4 File list display

**3. Turn the function dial (F•D) to select the .bsg file that you want to display.**

**4. Press F•1 RECALL.**

The file list display closes, and the capture menu appears.

**5. Press F•3 DISPLAY to select the display format.**

After you press F•1 RECALL, the display format is BOTH.

## 8.1.5 Deleting Screen Capture Data Saved to a USB Memory Device

To delete screen capture data that has been saved to a USB memory device, follow the procedure below.

(You can also use a PC to delete the data.)

**1. Press CAP.**

The capture menu appears.

**2. Press F•6 RECALL.**

The file list display appears.

This menu item appears when a USB memory device has been connected to the LV 5770A.

External USB FLASH DRIVE BitMap FILE LIST				
No.	File Name	Date	Time	Size(BYTE)
1	20110609132029.bsg	11/06/09	13:20	2,367,370
2	20110609132029.bmp	11/06/09	13:20	2,359,350
3	20110609132310.bsg	11/06/09	13:23	2,367,370
4	20110609132310.bmp	11/06/09	13:23	2,359,350

SIZE: 4,001,894,400byte  
FREE: 3,963,789,312byte

RECALL		DELETE FILE				up menu
--------	--	-------------	--	--	--	---------

Figure 8-5 File list display

**3. Turn the function dial (F•D) to select the file that you want to delete.**

**4. Press F•3 DELETE FILE.**

The deletion confirmation menu appears.

DELETE YES		DELETE NO				
------------	--	-----------	--	--	--	--

F•1
F•2
F•3
F•4
F•5
F•6
F•7

Figure 8-6 Deletion confirmation menu

**5. Press F•1 DELETE YES.**

To cancel the deletion operation, press F•3 DELETE NO.

## 8.2 Frame Capture (LV 5770SER08 and LV 5770SER09A)

## 8.2.1 Capturing Frame Data

There are two ways to capture frame data. One way is to capture frame data manually, and the other is to capture frame data automatically when errors occur (error capture).

1. **Press SDI.**
2. **Press WFM, VECT, or PIC.**

If you press VECT, press **F•6** DISPLAY and then **F•1** MODE to select VECTOR. This feature does not support the 5 bar display.

3. **Press CAP.**

The capture menu appears. If an error message appears, check steps 1 and 2. Unlike screen captures, frame data is not captured when you press CAP.

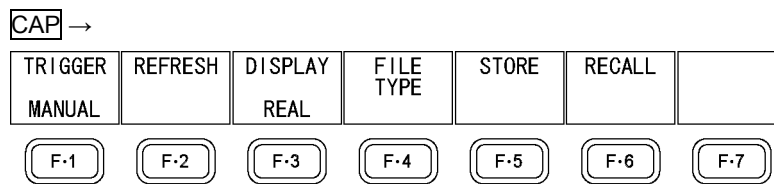

Figure 8-7 Capture menu

- **Capturing frame data manually**

4. **Press **F•1** TRIGGER to select MANUAL.**
5. **Press **F•2** REFRESH.**

One frame of data is captured in the LV 5770A. (In simul mode, the data of both channels A and B is captured.)

The captured frame data is cleared when you change the input channel or other settings.

## 8. CAPTURE FEATURE

- **Capturing frame data automatically (error capture)**

4. Press **F•1** TRIGGER to select ERROR.

5. Press **F•2** REFRESH.

The LV 5770A switches to error standby mode and displays the message “ERR CAP” at the top of the screen. The standby mode is cleared when you change the input channel or other settings.

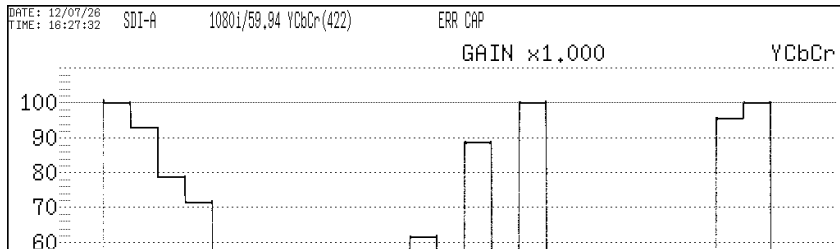

Figure 8-8 Error standby

6. When the message below appears, press any key except for the power key.

If an error occurs during error standby, the LV 5770A captures the frame data at that point and stops the frame capture. (In simul mode, if an error occurs on channel A or channel B, the LV 5770A captures the frame data of the channel in which the error occurred and stops the frame capture.)

The applicable errors are those listed under “Applicable Errors” below whose detection setting has been set to ON through **F•6** ERROR SETUP on the status menu.

Table 8-1 Applicable errors for error capturing

	Applicable Errors	Inapplicable Errors
SDI Error	TRS, Line Number, CRC, EDH, Illegal Code	Cable
Ancillary Data Error	Parity, Checksum	-
Embedded Audio Error	BCH, DBN, Parity, Inhibit Line	Sample Count
Video Error	Gamut, Composite Gamut, Level	Freeze, Black

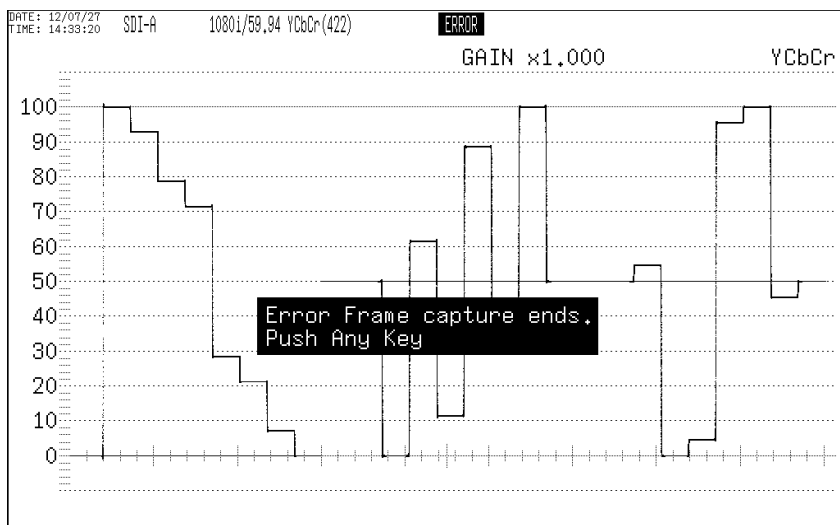

Figure 8-9 Error capture end

## 8.2.2 Displaying Frame Capture Data

You can display the captured frame data on the LV 5770A or overlay it on the current input signal. You can also display the frame data in different display modes.

To select the display mode, follow the procedure below.

- First, set the display mode to video signal waveform display, vector waveform display (except for the 5 bar display), or picture display.
- To display frame data, the LV 5770A must be receiving a signal whose format is the same as that of the captured data.
- The display may blink when you change the display area or operate the V POS knob, H POS knob, or function dial (F•D).
- The scale and measured values are those of the current signal, not those of the captured data.

## Procedure

---

**CAP** → **F•3** DISPLAY: REAL / HOLD / BOTH

---

## Settings

---

**REAL:** The current input signal is displayed.  
**HOLD:** The frame capture data is displayed. The waveform is displayed in cyan.  
**BOTH:** The current input signal and the frame capture data are displayed on top of each other with their intensities halved.

---

## 8.2.3 Saving to a USB Memory Device

The frame data captured in the LV 5770A is cleared when the power is turned off. If you want to display it later even after the power is turned off, save the data to USB memory by following the procedure below (save the data in FRM format). You can also view the saved data on your PC.

**1. Press **F•4** FILE TYPE on the capture menu.**

The file format selection menu appears.

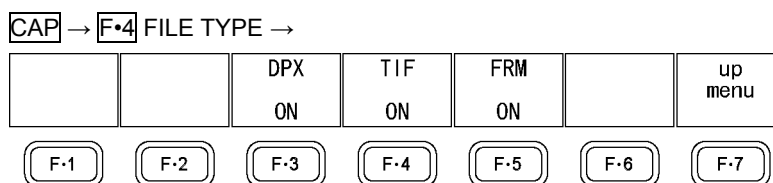

Figure 8-10 File format selection menu

**2. Select the file format.**

Set the file types for saving the data to ON. By default, all types are set to ON.

**F•3** DPX: Only the picture area is saved as 10-bit .dpx files.  
 Even when the input signal is 12 bits, it is rounded to 10 bits and saved.

**F•4** TIF: Only the picture area is saved as .tif files.  
 This data is DPX converted into TIF.

**F•5** FRM: A single frame of data is saved.

**3. Press F•7 up menu.**

The capture menu appears.

**4. Press F•5 STORE.**

The message “Saving file - Please Wait.” is displayed on the screen, and the frame capture data is saved to the USB memory device.

This menu item does not appear when a USB memory device is not connected, when all the file types that you can select with F•4 FILE TYPE are set to OFF, or when there is no frame data captured in the LV 5770A.

When the input signal is 1080i/59.94 and all the file types that you can select with F•4 FILE TYPE are set to ON, it takes about 50 seconds to save the data. The approximate file sizes for saving the data are 8.3 MB for DPX, 12.5 MB for TIF, and 9.9 MB for FRM.

The file is automatically assigned a name that consists of the year, month, day, hour, minute, and second (in that order) that are set in the system settings.

(Example: 20090501100859.bmp)

Frame capture data is saved to the following locations.

- └─ USB memory device
  - └─ LV5770A\_USER
    - └─ BMP
      - └─ yyyyymmddhhmmss.dpx
      - └─ yyyyymmddhhmmss.frm
      - └─ yyyyymmddhhmmss.tif

## 8.2.4 Displaying Frame Capture Data Saved to a USB Memory Device

To display or overlay on the current input signal the frame capture data that has been saved to USB memory as .frm files, follow the procedure below.

(Frame capture data that has been saved in FRM format on a different model cannot be displayed on the LV 5770A.)

**1. Press F•6 RECALL on the capture menu.**

The file list display appears.

This menu item appears when a USB memory device has been connected to the LV 5770A.

External USB FLASH DRIVE FRAME FILE LIST				
No.	File Name	Date	Time	Size(BYTE)
1	20120725145804.frm	12/07/25	14:58	9,900,064
2	20120725145804.dpx	12/07/25	14:58	8,296,480
3	20120725145804.tif	12/07/25	14:58	12,450,544
4	20120727110201.dpx	12/07/27	11:02	8,296,480
5	20120727110242.tif	12/07/27	11:02	12,450,544
6	20120727110327.frm	12/07/27	11:03	9,900,064
7	20120727110355.frm	12/07/27	11:04	9,900,064
8	20120727110441.frm	12/07/27	11:04	9,900,064
9	20120727110441.dpx	12/07/27	11:05	8,296,480
10	20120727110441.tif	12/07/27	11:05	12,450,544
SIZE: 4,001,894,400byte				
FREE: 3,753,431,040byte				
FORMAT: HD,1080I,59.94,YCBCR_422,10BIT,1920				
RECALL		DELETE FILE		up menu

Figure 8-11 File list display

**2. Turn the function dial (F•D) to select the .frm file that you want to display.**

**3. Press F•1 RECALL.**

To display frame data, the LV 5770A must be receiving a signal whose format is the same as that of the saved data. The FORMAT item at the bottom of the display shows the format of the saved data. It is displayed in green if the format is the same as the current format or in red if the format is not the same. If the FORMAT item is in red, F•1 RECALL does not appear.

**4. Press F•3 DISPLAY to select the display format.**

After you press F•1 RECALL, the display format is BOTH.

8.2.5 Deleting Frame Capture Data Saved to a USB Memory Device

To delete frame capture data that has been saved to a USB memory device, follow the procedure below.

(You can also use a PC to delete the data.)

1. Press **F•6** **RECALL** on the capture menu.

The file list display appears.

This menu item appears when a USB memory device has been connected to the LV 5770A.

External USB FLASH DRIVE FRAME FILE LIST				
No.	File Name	Date	Time	Size(BYTE)
1	20120725145804.frm	12/07/25	14:58	9,900,064
2	20120725145804.dpx	12/07/25	14:58	8,296,480
3	20120725145804.tif	12/07/25	14:58	12,450,544
4	20120727110201.dpx	12/07/27	11:02	8,296,480
5	20120727110242.tif	12/07/27	11:02	12,450,544
6	20120727110327.frm	12/07/27	11:03	9,900,064
7	20120727110355.frm	12/07/27	11:04	9,900,064
8	20120727110441.frm	12/07/27	11:04	9,900,064
9	20120727110441.dpx	12/07/27	11:05	8,296,480
10	20120727110441.tif	12/07/27	11:05	12,450,544

SIZE: 4,001,894,400byte  
 FREE: 3,753,431,040byte

FORMAT: HD,1080I,59.94,YCBCR\_422,10BIT,1920

RECALL		DELETE FILE				up menu
--------	--	-------------	--	--	--	---------

Figure 8-12 File list display

2. Turn the function dial (**F•D**) to select the file that you want to delete.

3. Press **F•3** **DELETE FILE**.

The deletion confirmation menu appears.

DELETE YES		DELETE NO				
(F•1)	(F•2)	(F•3)	(F•4)	(F•5)	(F•6)	(F•7)

Figure 8-13 Deletion confirmation menu

4. Press **F•1** **DELETE YES**.

To cancel the deletion operation, press **F•3** **DELETE NO**.



## 9. PRESET FEATURE

You can register up to 60 sets of panel settings to presets. Also, you can use the same settings on multiple LV 5770As by copying presets to a USB memory device.

Preset settings are not deleted even if you initialize the instrument's settings.

You cannot register the following items to presets.

- Ethernet settings (ETHERNET SETUP)
- Remote control settings (REMOTE SETUP)
- Date and time settings (DATE&TIME)

### 9.1 Registering Presets

To register a preset, follow the procedure below.

1. **Set the LV 5770A to the settings that you want to register.**
2. **Press MEM.**

The preset registration display appears.

Internal Memory		FILE LIST			
No.	File COMMENT	Date	Time	Size(BYTE)	
1	5BAR	11/06/09	14:08	8,020	
2	JITTER	11/06/09	14:08	8,020	
3	AUDIO STATUS	11/06/09	14:08	8,020	
4	-----	-----	-----	-----	
5	-----	-----	-----	-----	
6	-----	-----	-----	-----	
7	-----	-----	-----	-----	
8	-----	-----	-----	-----	
9	-----	-----	-----	-----	
10	-----	-----	-----	-----	
11	-----	-----	-----	-----	
12	-----	-----	-----	-----	

SETUP MEMORY COMMENT					
COMMENT INPUT	STORE	DELETE		ALL COPY USB->INT	ALL COPY INT->USB

Figure 9-1 Preset registration display

3. Press **F•1** COMMENT INPUT.

The comment input display appears.

You can also copy a comment from a preset that already has a comment saved to it. To copy a comment, on the preset registration display, move the cursor to the preset that has the comment that you want to copy, and press the function dial (F•D).

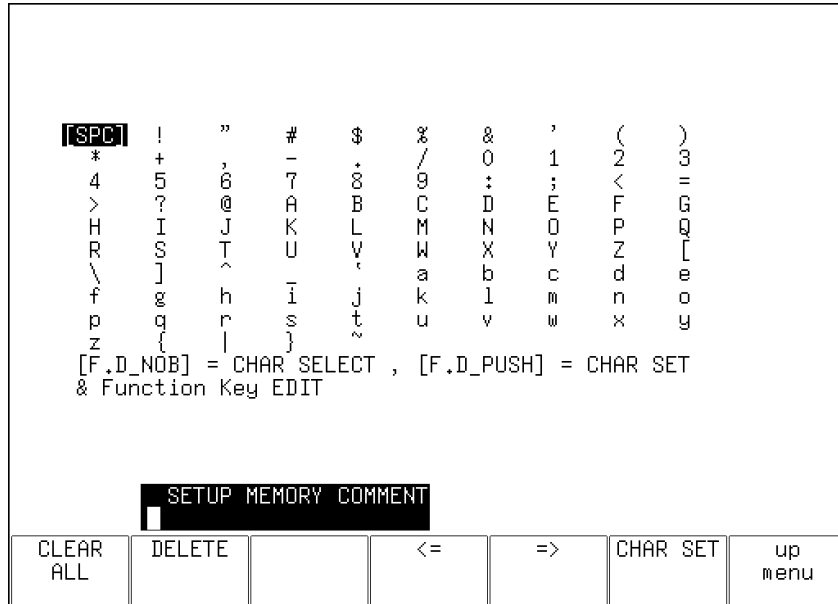

Figure 9-2 Comment input display

4. Enter a comment of up to 16 characters.

You can use the following keys on the comment input display.

- F•1** CLEAR ALL: Deletes all the characters.
- F•2** DELETE: Deletes the character at the cursor position.
- F•4** <=: Moves the cursor to the left.
- F•5** =>: Moves the cursor to the right.
- F•6** CHAR SET: Enters the selected character.
- Function dial (F•D): Turn to select the character. Press to enter the selected character.

5. Press **F•7** up menu.

6. Turn the function dial (F•D) to select the number of the preset you want to register.

7. Press **F•2** STORE.

When the message "Saving data - Please Wait." disappears, the preset has been successfully registered.

If a preset has already been stored with the number that you selected, the overwrite confirmation menu appears. If you want to overwrite the existing preset, press **F•1** OVER WR YES. Otherwise, press **F•3** OVER WR NO.

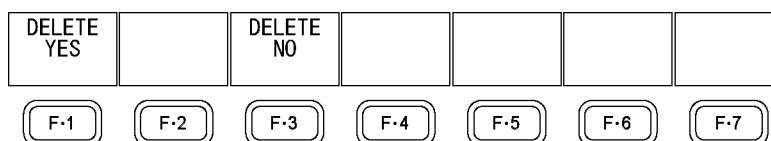

Figure 9-3 Overwrite confirmation menu

## 9.2 Loading Presets

To load a preset, follow the procedure below.

### 1. Press RCLL.

The preset load menu appears.

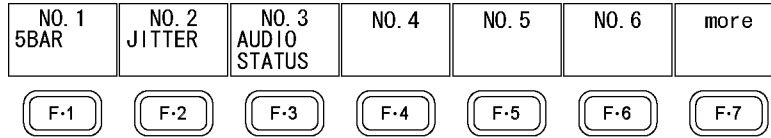

Figure 9-4 Preset load menu

### 2. Press a key from **F-1 NO.1** to **F-6 NO.6**.

If the preset that you want to load is number 7 or greater, press **F-7** more or turn the function dial (F•D).

## 9.3 Deleting Presets

To delete a preset, follow the procedure below.

### 1. Press MEM.

The preset registration display appears.

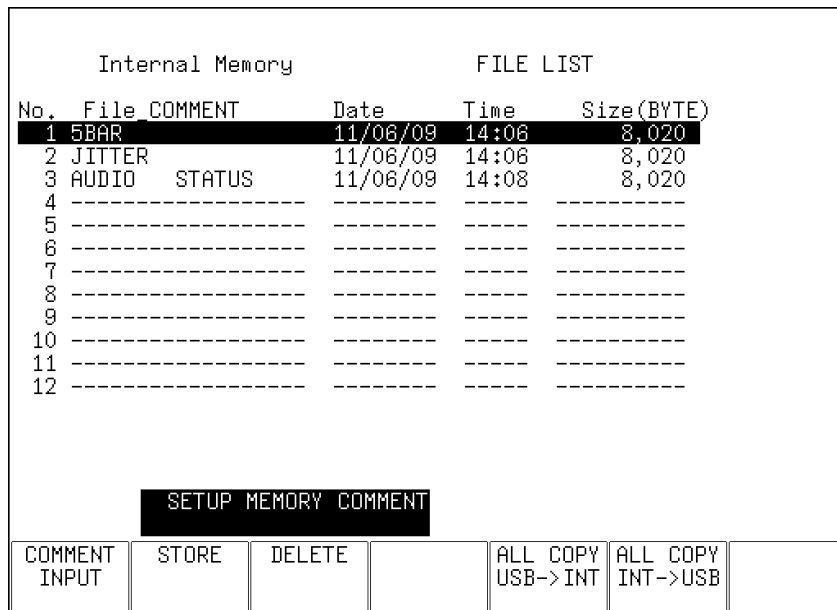

Figure 9-5 Preset registration display

### 2. Turn the function dial (F•D) to select the file that you want to delete.

### 3. Press **F-3** DELETE.

The deletion confirmation menu appears.

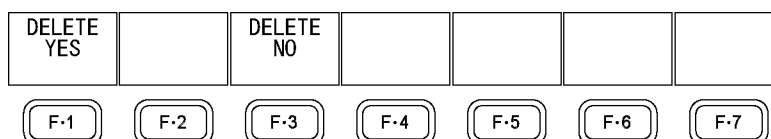

Figure 9-6 Deletion confirmation menu

4. Press **F•1** **DELETE YES.**

To cancel the deletion operation, press **F•3** **DELETE NO.**

9.4 Copying All Presets

9.4.1 Copying All Presets from the LV 5770A to a USB Memory Device

To copy all the presets from the LV 5770A to a USB memory device, follow the procedure below.

1. Press **MEM.**

The preset registration display appears.

Internal Memory			FILE LIST		
No.	File COMMENT	Date	Time	Size(BYTE)	
1	5BAR	11/08/09	14:08	8,020	
2	JITTER	11/08/09	14:08	8,020	
3	AUDIO STATUS	11/08/09	14:08	8,020	
4	-----	-----	-----	-----	
5	-----	-----	-----	-----	
6	-----	-----	-----	-----	
7	-----	-----	-----	-----	
8	-----	-----	-----	-----	
9	-----	-----	-----	-----	
10	-----	-----	-----	-----	
11	-----	-----	-----	-----	
12	-----	-----	-----	-----	

<b>SETUP MEMORY COMMENT</b>					
COMMENT INPUT	STORE	DELETE		ALL COPY USB->INT	ALL COPY INT->USB

Figure 9-7 Preset registration display

2. Press **F•6** **ALL COPY INT->USB.**

The copy confirmation menu appears.

This menu item appears when a USB memory device has been connected to the LV 5770A.

COPY YES		COPY NO				
<b>F•1</b>	<b>F•2</b>	<b>F•3</b>	<b>F•4</b>	<b>F•5</b>	<b>F•6</b>	<b>F•7</b>

Figure 9-8 Copy confirmation menu

3. Press **F•1** **COPY YES.**

To cancel the copy operation, press **F•3** **COPY NO.** If presets already exist on the USB memory device, they will be overwritten.

Presets are saved to the following location.

Note that the file numbers on the USB memory device are different from the LV 5770A preset numbers by one. If you use a PC to change the names of the files stored on the USB memory device, you will no longer be able to copy the altered presets from the USB memory device to an LV 5770A.

## 9. PRESET FEATURE

- ┆ USB memory device
- ┆ LV5770A\_USER
  - ┆ PSET
    - ┆ PRESET\_00.PRE (to PRESET\_59.PRE) .....Preset number 1 to number 60

### 9.4.2 Copying All Presets from a USB Memory Device to the LV 5770A

To copy all the presets from a USB memory device to the LV 5770A, follow the procedure below.

#### 1. Press MEM.

The preset registration display appears.

Internal Memory			FILE LIST			
No.	File	COMMENT	Date	Time	Size(BYTE)	
1	5BAR		11/06/09	14:06	8,020	
2	JITTER		11/06/09	14:06	8,020	
3	AUDIO	STATUS	11/06/09	14:08	8,020	
4	-----		-----	-----	-----	
5	-----		-----	-----	-----	
6	-----		-----	-----	-----	
7	-----		-----	-----	-----	
8	-----		-----	-----	-----	
9	-----		-----	-----	-----	
10	-----		-----	-----	-----	
11	-----		-----	-----	-----	
12	-----		-----	-----	-----	

SETUP MEMORY COMMENT						
COMMENT INPUT	STORE	DELETE		ALL COPY USB->INT	ALL COPY INT->USB	

Figure 9-9 Preset registration display

#### 2. Press **F•5** ALL COPY USB->INT.

The copy confirmation menu appears.

This menu item appears when a USB memory device has been connected to the LV 5770A.

COPY YES		COPY NO				
(F-1)	(F-2)	(F-3)	(F-4)	(F-5)	(F-6)	(F-7)

Figure 9-10 Copy confirmation menu

#### 3. Press **F•1** COPY YES.

To cancel the copy operation, press **F•3** COPY NO. If presets already exist within the LV 5770A internal memory, they will be overwritten.

## 10. REMOTE CONTROL

You can use the remote control connector on the rear panel to load presets, transmit alarm signals, and perform other operations. Use the supplied 15-pin D-sub connector to control the LV 5770A.

- **Pinout Example**

This section contains a diagram of the remote control connector, displayed as it appears on the rear panel, and a table that describes the connector's pinout.

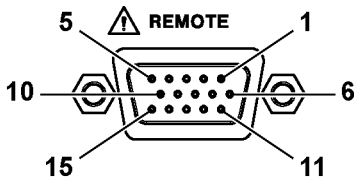

Figure 10-1 Remote control connector (female, inch screws)

Table 10-1 Remote control connector pinout example

Pin No.	Name	I/O	Function
1	GND	-	Ground
2	/P1	I	Loads preset 1
3	/P2	I	Loads preset 2
4	/P3	I	Loads preset 3
5	/P4	I	Loads preset 4
6	/P5	I	Loads preset 5
7	/P6	I	Loads preset 6
8	/P7	I	Loads preset 7 / clear the loudness measurement (*1)
9	/P8	I	Loads preset 8 / start/stop the loudness measurement (*1)
10	/ACH	I	Selects channel A
11	/BCH	I	Selects channel B
12	RESERVE	-	Reserved
13	RESERVE	-	Reserved
14	ALARM	O	Transmits alarms
15	GND	-	Ground

\*1 When Remote Select is set to Recall, preset recalling is enabled. When it is set to Recall and Loudness, loudness measurement control is enabled. Loudness measurement requires an LV 5770SER41 or LV 5770SER43.

- **Configuring the LV 5770A**

To set the remote control connector, use the system settings. For details, see section 7.2.3, “Remote Control Settings.”

**SYS** → **F•2** SYSTEM SETUP → **F•3** NEXT TAB → **F•3** NEXT TAB →

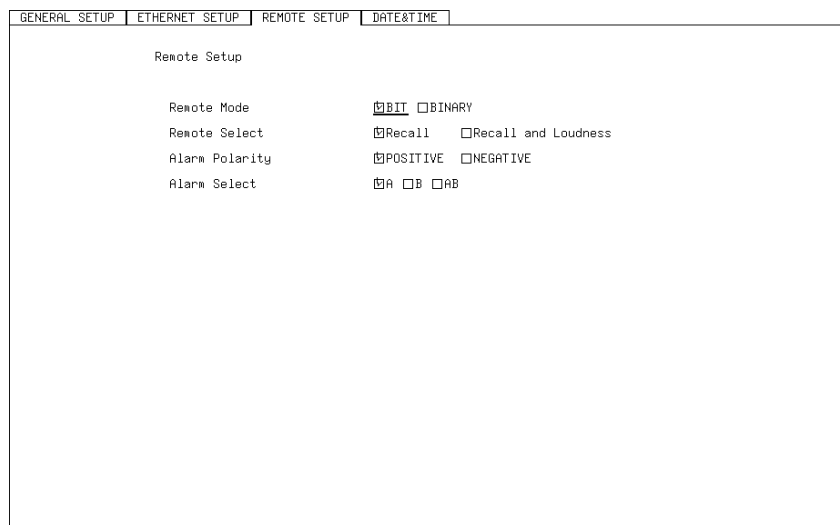

Figure 10-2 REMOTE SETUP tab

- **Remote Control**

The input connectors respond to active-low signals. Do not apply negative voltages or voltages that exceed +5 V. After you make a setting, a period of time of 350 ms or more in which the electrical potential is stable is required, so wait at least 1 second before you make the subsequent setting.

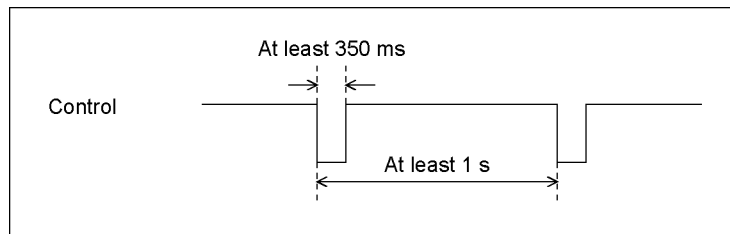

Figure 10-3 Remote control timing 1

## 10. REMOTE CONTROL

After a setting is made, it may take about 3 seconds for the operation to finish. If you configure subsequent settings before the initial operation finishes, only the last setting will take effect. All settings in between will be discarded. (In the following example, remote control 2 will be discarded.)

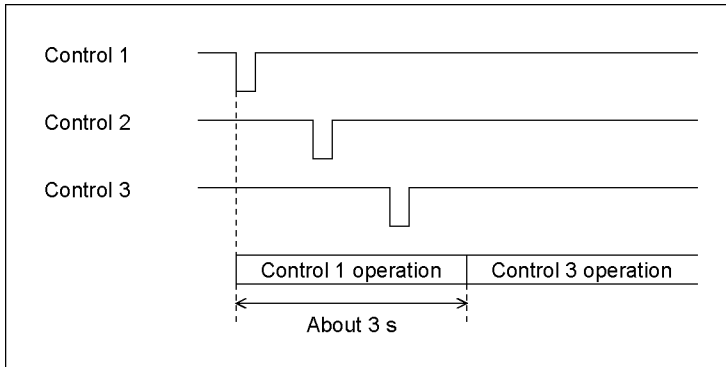

Figure 10-4 Remote control timing 2

- **Loading Presets**

The control table when Remote Mode is set to BIT is shown below.

When Remote Select is set to Recall and Loudness, preset No. 7 and 8 cannot be recalled.

Table 10-2 Loading presets (BIT)

Preset No.	9p	8p	7p	6p	5p	4p	3p	2p
	/P8	/P7	/P6	/P5	/P4	/P3	/P2	/P1
1	H	H	H	H	H	H	H	L
2	H	H	H	H	H	H	L	H
3	H	H	H	H	H	L	H	H
4	H	H	H	H	L	H	H	H
5	H	H	H	L	H	H	H	H
6	H	H	L	H	H	H	H	H
7	H	L	H	H	H	H	H	H
8	L	H	H	H	H	H	H	H



10. REMOTE CONTROL

The control table when Remote Mode is set to BINARY is shown below.

Table 10-3 Loading presets (BINARY)

Preset No.	7p	6p	5p	4p	3p	2p
	/P6	/P5	/P4	/P3	/P2	/P1
1	H	H	H	H	H	L
2	H	H	H	H	L	H
3	H	H	H	H	L	L
4	H	H	H	L	H	H
5	H	H	H	L	H	L
6	H	H	H	L	L	H
7	H	H	H	L	L	L
8	H	H	L	H	H	H
9	H	H	L	H	H	L
10	H	H	L	H	L	H
11	H	H	L	H	L	L
12	H	H	L	L	H	H
13	H	H	L	L	H	L
14	H	H	L	L	L	H
15	H	H	L	L	L	L
16	H	L	H	H	H	H
17	H	L	H	H	H	L
18	H	L	H	H	L	H
19	H	L	H	H	L	L
20	H	L	H	L	H	H
21	H	L	H	L	H	L
22	H	L	H	L	L	H
23	H	L	H	L	L	L
24	H	L	L	H	H	H
25	H	L	L	H	H	L
26	H	L	L	H	L	H
27	H	L	L	H	L	L
28	H	L	L	L	H	H
29	H	L	L	L	H	L
30	H	L	L	L	L	H
31	H	L	L	L	L	L
32	L	H	H	H	H	H
33	L	H	H	H	H	L
34	L	H	H	H	L	H
35	L	H	H	H	L	L
36	L	H	H	L	H	H
37	L	H	H	L	H	L
38	L	H	H	L	L	H
39	L	H	H	L	L	L
40	L	H	L	H	H	H
41	L	H	L	H	H	L

## 10. REMOTE CONTROL

Preset No.	7p	6p	5p	4p	3p	2p
	/P6	/P5	/P4	/P3	/P2	/P1
42	L	H	L	H	L	H
43	L	H	L	H	L	L
44	L	H	L	L	H	H
45	L	H	L	L	H	L
46	L	H	L	L	L	H
47	L	H	L	L	L	L
48	L	L	H	H	H	H
49	L	L	H	H	H	L
50	L	L	H	H	L	H
51	L	L	H	H	L	L
52	L	L	H	L	H	H
53	L	L	H	L	H	L
54	L	L	H	L	L	H
55	L	L	H	L	L	L
56	L	L	L	H	H	H
57	L	L	L	H	H	L
58	L	L	L	H	L	H
59	L	L	L	H	L	L
60	L	L	L	L	H	H

- **Controlling the Loudness Measurement**

The control table when Remote Select is set to Recall and Loudness is shown below.

Table 10-4 Controlling the loudness measurement

	9p (/P8)	8p (/P7)
Clear the loudness measurement	-	L
Start the loudness measurement	L	-
Stop the loudness measurement	H	-

## 11. ETHERNET REMOTE CONTROL

The LV 5770A can be remotely controlled through its Ethernet port on the rear panel. Controlling an LV 5770A remotely through its Ethernet interface has only been confirmed to work in a local network environment. LEADER does not guarantee that this feature will work in any network environment.

This section explains the case when NETWORK MODE is set to LV5770A under ETHERNET SETUP in the system settings. If you set it to LV5770, see the explanation of NETWORK MODE in section 7.2.2, "Configuring Ethernet Settings."

### 11.1 TELNET

From a PC connected to the same network as the LV 5770A, most of the operations that you can perform from the front panel can be controlled remotely.

#### 11.1.1 Procedure

##### 1. Configure the Ethernet settings on the LV 5770A's ETHERNET SETUP tab.

Set the IP Address, and set TELNET Server Select to ON.

You cannot use the LV 7770-01 (REMOTE CONTROLLER) while you are using TELNET. Conversely, if you set LV7770-01 to ON, you cannot use TELNET.

Reference 7.2.2, "Configuring Ethernet Settings"

SYS → F•2 SYSTEM SETUP → F•3 NEXT TAB →

GENERAL SETUP	ETHERNET SETUP	REMOTE SETUP	DATE&TIME
Ethernet Select		<input type="checkbox"/> DHCP	<input checked="" type="checkbox"/> IP
TCP / IP			
IP Address		<input type="text" value="192"/>	<input type="text" value="168"/> <input type="text" value="0"/> <input type="text" value="1"/>
Subnet Mask		<input type="text" value="255"/>	<input type="text" value="255"/> <input type="text" value="255"/> <input type="text" value="0"/>
Default Gateway		<input type="text" value="0"/>	<input type="text" value="0"/> <input type="text" value="0"/> <input type="text" value="0"/>
SNTP Client Select		<input checked="" type="checkbox"/> OFF	<input type="checkbox"/> ON
Server IP Address		<input type="text" value="0"/>	<input type="text" value="0"/> <input type="text" value="0"/> <input type="text" value="0"/>
Time Zone Adjust		<input type="text" value="+"/>	<input type="text" value="9"/> : <input type="text" value="0"/> [ +/- hour : minutes ]
TELNET Server Select		<input type="checkbox"/> OFF	<input checked="" type="checkbox"/> ON <input type="checkbox"/> LV7770-01
FTP Server Select		<input checked="" type="checkbox"/> OFF	<input type="checkbox"/> ON
HTTP Server Select		<input checked="" type="checkbox"/> OFF	<input type="checkbox"/> ON
SNMP READ		<input checked="" type="checkbox"/> OFF	<input type="checkbox"/> ONLY <input type="checkbox"/> WRITE
SNMP TRAP		<input checked="" type="checkbox"/> OFF	<input type="checkbox"/> ON
NETWORK MODE		<input type="checkbox"/> LV5770	<input checked="" type="checkbox"/> LV5770A
MAC ADDRESS: 00:00:00:00:00:00			

Figure 11-1 ETHERNET SETUP tab

##### 2. Press F•1 COMPLETE.

The message "Saving data - Please Wait" is displayed.

##### 3. If you changed the IP address, after the message disappears, restart the LV 5770A.

The new IP address will take effect.

##### 4. Connect the LV 5770A's Ethernet port to the network.

Use a UTP cable (category 5).

**5. On the PC, start a TELNET client.**

On Windows 7, on the taskbar, click Start, and then click Run. Type "TELNET " and the IP address that you set in step 1. Then, click OK.

(To use TELNET, open Control Panel, click Turn Windows features on or off under Program and Features, and select the Telnet Client check box.)

**6. Type the login name and password.**

The login name and password are "LV5770A". Use uppercase for all characters. When the login name and password are entered correctly, "LV5770A>" appears.

```
login: LV5770A
Password: *****
LV5770A>
```

**7. Enter TELNET commands.**

Enter commands while referring to sections 11.1.2, "How to Enter Commands," and 11.1.3, "TELNET Commands."

To end a TELNET session, type "bye" in lowercase letters.

```
LV5770A> bye
```

**11.1.2 How to Enter Commands**

The command syntax is explained below. (Some commands do not have parameters.) To query a current setting, use a question mark as the parameter.

```
LV5770A> [Command] + [Space] + [Parameter]
```

Examples of how to enter commands are shown below. With the factory default settings, return values are returned only for queries. If you want the LV 5770A to output return values for all commands, send a "REMOTE:REPLY" with the parameter set to ON.

```
LV5770A> STATUS:ERROR:CLEAR..... Reset the error on the status screen.
OK ..... Return value
LV5770A> WFM:GAIN:MAG X5 ..... Set the gain of the video signal waveform to 5x.
OK ..... Return value
LV5770A> VECTOR:INTEN:SCALE ?..... Query the vector scale intensity.
4..... Return value
LV5770A>
```

- \* You can enter commands using uppercase or lowercase letters.
- \* Commands that begin with "WFM," "VECTOR," "PICTURE," "STATUS," "EYE," or "AUDIO" only apply to the area (1 to 4) that is specified by the DISPLAY command. Commands for a mode that is different from the current display mode are invalid.
- \* \* When using TELNET, enable flow control.  
If your Telnet client does not support flow control, the LV 5770A may not operate properly when commands are transferred at a high speed. In this situation, wait approximately 1 second between commands, or send the "REMOTE:REPLY" command to enable return values and perform software handshaking.

## 11.1.3 TELNET Commands

TELNET commands follow the LV 5770A or the unit menu structure. For explanations of each item, see the LV 5770A or the unit instruction manual. Depending on the current settings, some of the items that are described in this manual may be invalid.

Table 11-1 LV 5770A commands

Command	Parameter
INPUT:UNIT	SDI / CMP / ?
INPUT:CH	A / B / AB / ?
INPUT:SIMUL	ON / OFF / ?
INPUT:STREAM	1 / 2 / ?
EXT	INT / EXT / ?
DISPLAY	1 / 2 / 3 / 4 / ?
MULTI	ON / OFF / ?
MODE	WFM / VECTOR / PICTURE / AUDIO / STATUS / EYE / ?
RCLL	1 to 60
CAP:TRIGGER	MANUAL / ERROR / ?
SYS:FORMAT:MANUAL_SELECT	AUTO / MANUAL / ?
SYS:FORMAT:I_PSF	INTERLACE / SEGMENTED_FRAME / ?
SYS:FORMAT:LINK_FORMAT	HD / SD / HD_DUAL / 3GA / 3GB / 3GB_2MAP / ?
SYS:FORMAT:COLOR_SYSTEM	YCBCR_422 / YCBCR_444 / RGB_444 / ?
SYS:FORMAT:PIXEL_DEPTH	10BIT / 12BIT / ?
SYS:FORMAT:SCANNING	1080P / 1080I / 1080PSF / 720P / 525I / 625I / ?
SYS:FORMAT:ACTIVE_SAMPLE	1920 / 2048 / ?
SYS:FORMAT:FRAME_RATE	60 / 59.94 / 50 / 30 / 29.97 / 25 / 24 / 23.98 / ?
SYS:FORMAT:INPUT:A	? (Return value: Link Format / Scanning / Frame Rate / Color System / Pixel Depth / Active Sample / NO_SIGNAL / UNKNOWN) * When Scanning is set to I, Frame Rate is converted to field frequency. * When Scanning is set to 720P, 525I, or 625I, return values for Pixel Depth and later items are not output. * When the input signal is COMPOSITE, Link Format is set to NTSC or PAL, and the return values for Color System and later items are not output.
SYS:FORMAT:INPUT:B	? (Return value: same as above)
SYS:REAR:SDI_OUTPUT	A_B / A / ?
SYS:REAR:AUDIO_BNC:GRP_A	INPUT / OUTPUT / ?
SYS:REAR:AUDIO_BNC:GRP_B	INPUT / OUTPUT / ?
SYS:REAR:AUDIO_BNC:GRP_A:OUT_SEL	DISP_SRC / SDI_1_8 / ?
SYS:REAR:AUDIO_BNC:GRP_B:OUT_SEL	DISP_SRC / SDI_9_16 / ?
SYS:REAR:ANALOG_AUDIO	INPUT / OUTPUT
SYS:REAR:DVI_I:ASPECT	4_3 / 16_9 / 16_10 / ?
SYS:REAR:PIC_MONI_OUT:COLOR	AUTO / YCBCR_422 / YCBCR_444 / RGB_444 / ?

## 11. ETHERNET REMOTE CONTROL

Command	Parameter
SYS:REAR:PIC_MONI_OUT:PIXEL_DEPTH	AUTO / 8BIT / 10BIT / 12BIT / ?
SYS:REAR:PIC_MONI_OUT:2MAPPING	STREAM1 / STREAM2 / ?
SYS:GENERAL:MULTI_DISPLAY	2MULTI / 4MULTI / ?
SYS:GENERAL:CAPTURE_MODE	SCREEN / VIDEO_FRAME / ?
SYS:GENERAL:MEM_STR_MODE	LOUD2H / LOUD32H / ?
SYS:GENERAL:INFO:FORMAT	ON / OFF / ?
SYS:GENERAL:INFO:DATE	OFF / YMD / MDY / DMY / ?
SYS:GENERAL:INFO:TIME	OFF / REAL / LTC / VITC / D_VITC / ?
SYS:GENERAL:INFO:COLOR_SYSTEM	ON / OFF / ?
SYS:GENERAL:INFO:INPUT	ON / OFF / ?
SYS:GENERAL:LCD:AUTO_OFF	OFF / 5MIN / 30MIN / 60MIN / ?
SYS:GENERAL:MENU:AUTO_OFF_CTR	OFF / ON / ?
SYS:GENERAL:MENU:AUTO_OFF	1 to 60 / ?
SYS:ETHERNET:SELECT	? (Return value: DHCP / IP)
SYS:ETHERNET:ADDRESS	? (Return value: IP Address)
SYS:ETHERNET:SUBNET	? (Return value: Subnet Mask)
SYS:ETHERNET:GATEWAY	? (Return value: Default Gateway)
SYS:ETHERNET:SNTP:SELECT	OFF / ON / ?
SYS:ETHERNET:SNTP:ADR:1	0 to 255 / ? (aaa of aaa.bbb.ccc.ddd)
SYS:ETHERNET:SNTP:ADR:2	0 to 255 / ? (bbb of aaa.bbb.ccc.ddd)
SYS:ETHERNET:SNTP:ADR:3	0 to 255 / ? (ccc of aaa.bbb.ccc.ddd)
SYS:ETHERNET:SNTP:ADR:4	0 to 255 / ? (ddd of aaa.bbb.ccc.ddd)
SYS:ETHERNET:SNTP:ADDRESS	? (Return value: Server IP Address)
SYS:ETHERNET:SNTP:TZ:POLE	+ / - / ?
SYS:ETHERNET:SNTP:TZ:HOURL	0 to 23 / ?
SYS:ETHERNET:SNTP:TZ:MINUTE	0 to 59 / ?
SYS:ETHERNET:SNTP:TIMEZONE	? (Return value: ±0:0 to ±23:59)
SYS:ETHERNET:SNTP:SET	None (SNTP reconfiguration)
SYS:ETHERNET:FTP:SELECT	OFF / ON / ?
SYS:ETHERNET:HTTP:SELECT	OFF / ON / ?
SYS:ETHERNET:MAC	? (Return value: MAC ADDRESS)
SYS:REMOTE:MODE	BIT / BINARY / ?
SYS:REMOTE:SELECT	RECALL / RECALL_LOUDNESS / ?
SYS:REMOTE:ALARM:POLARITY	POSITIVE / NEGATIVE / ?
SYS:REMOTE:ALARM:SELECT	A / B / AB / ?
SYS:DATE:YEAR	1970 to 2099 / ?
SYS:DATE:MONTH	1 to 12 / ?
SYS:DATE:DAY	1 to 31 / ?
SYS:TIME:HOURL	0 to 23 / ?
SYS:TIME:MINUTE	0 to 59 / ?
SYS:TIME:SECOND	0 to 59 / ?
SYS:DATE_TIME:SET	None (date and time reconfiguration)
SYS:DATE_TIME	? (Return value: YYYY/MM/DD hh:mm:ss)
SYS:INFO:FIRMWARE	? (Return value: FIRMWARE)
SYS:INFO:BOARD:SDI_INPUT	? (Return value: 0 (not installed) / 1 (installed))

## 11. ETHERNET REMOTE CONTROL

Command	Parameter
SYS:INFO:BOARD:EYE_PATTERN	? (Return value: 0 (not installed) / 1 (installed))
SYS:INFO:BOARD:COMPOSITE_VIDEO	? (Return value: 0 (not installed) / 1 (installed))
SYS:INFO:BOARD:AUDIO_DIGITAL_41	? (Return value: 0 (not installed) / 1 (installed))
SYS:INFO:BOARD:AUDIO_ANALOG	? (Return value: 0 (not installed) / 1 (installed))
SYS:INFO:BOARD:AUDIO_DIGITAL_43	? (Return value: 0 (not installed) / 1 (installed))
SYS:SHORTCUT	DIRECT / VOLUME / CAP&WRIT / INTEN / MENU_OFF / ?
SYS:LCD_OFF	None
SYS:LCD_ON	None
SYS:INIT	None
SYS:BACKLIGHT	1 to 16 / ?
SYS:KEYLOCK	OFF / ON / ?
REMOTE:REPLY	<p>OFF / ON / ? (return value on or off. The factory default setting is off.)</p> <p>* When set to ON, the following return values are output.</p> <p>OK: The command was processed properly.</p> <p>ERR1: The value of a parameter was outside of its acceptable range.</p> <p>ERR2: The command is invalid in the current condition.</p>

Table 11-2 LV 5770SER08 and LV 5770SER09A commands

Command	Parameter
WFM	None
WFM:CH1	ON / OFF / ?
WFM:CH2	ON / OFF / ?
WFM:CH3	ON / OFF / ?
WFM:OVLAY	ON / OFF / ?
WFM:INTEN:WFM	-128 to 127 / ?
WFM:COLOR	WHITE / YELLOW / CYAN / GREEN / MAGENTA / RED / BLUE / MULTI / ?
WFM:COLOR:2MAP_S1	WHITE / YELLOW / CYAN / GREEN / MAGENTA / RED / BLUE / MULTI / ?
WFM:COLOR:2MAP_S2	WHITE / YELLOW / CYAN / GREEN / MAGENTA / RED / BLUE / MULTI / ?
WFM:INTEN:SCALE	-8 to 7 / ?
WFM:SCALE:COLOR	WHITE / YELLOW / CYAN / GREEN / MAGENTA / RED / BLUE / ?
WFM:SCALE:UNIT	HDV_SDP / HDV_SDV / HDP_SDP / 150P / 1023 / 3FF / 1023_255 / ?
WFM:SCALE:COLOR75P	ON / OFF / ?
WFM:GAIN:VAR	CAL / VAR / ?
WFM:GAIN:VAL	0.200 to 10.000 / ?
WFM:GAIN:MAG	X1 / X5 / ?

## 11. ETHERNET REMOTE CONTROL

Command	Parameter
WFM:FILTER:NORMAL	FLAT / LOWPASS / ?
WFM:FILTER:COMPOSITE	FLAT / LUM / FLAT_LUM / LUM_CRMA / ?
WFM:SWEEP:SWEEP	H / V / ?
WFM:SWEEP:H_SWEEP	1H / 2H / ?
WFM:SWEEP:V_SWEEP	1V / 2V / ?
WFM:SWEEP:H_MAG	X1 / X10 / X20 / ACTIVE / BLANK / ?
WFM:SWEEP:V_MAG	X1 / X20 / X40 / ?
WFM:SWEEP:FIELD	FIELD1 / FIELD2 / ?
WFM:BLANKING:NORMAL	REMOVE / H_VIEW / V_VIEW / ALL_VIEW / ?
WFM:BLANKING:COMPOSITE	REMOVE / V_VIEW / ?
WFM:LINE_SELECT	ON / ACH / BCH / BOTH / 2MAP_S1 / 2MAP_S2 / OFF / CINELITE / ?
WFM:LINE_SELECT:FIELD	FIELD1 / FIELD2 / FRAME / ?
WFM:LINE_NUMBER	1 to 1125 / ?
WFM:DISPLAY:SIMUL	MIX / ALIGN / ?
WFM:DISPLAY:2MAP	STREAM1 / STREAM2 / MIX / ALIGN / ?
WFM:DISPLAY:THUMBNAIL:AUDIO	ON / OFF / ?
WFM:DISPLAY:THUMBNAIL:PICTURE	ON / OFF / ?
WFM:DISPLAY:THUMBNAIL:HISTO	ON / OFF / ?
WFM:DISPLAY:THUMBNAIL:HISTO:FORM	LUMA / ALIGN / MIX / ?
WFM:DISPLAY:THUMBNAIL:HISTO:Y	ON / OFF / ?
WFM:DISPLAY:THUMBNAIL:HISTO:R	ON / OFF / ?
WFM:DISPLAY:THUMBNAIL:HISTO:G	ON / OFF / ?
WFM:DISPLAY:THUMBNAIL:HISTO:B	ON / OFF / ?
WFM:MATRIX	YCBCR / GBR / RGB / COMPOSITE / ?
WFM:MATRIX:YGBR	ON / OFF / ?
WFM:MATRIX:YRGB	ON / OFF / ?
WFM:MATRIX:COMPOSITE:FORMAT	AUTO / NTSC / PAL / ?
WFM:MATRIX:SETUP	0P / 7.5P / ?
VECTOR	None
VECTOR:INTEN:VECTOR	-128 to 127 / ?
VECTOR:COLOR	WHITE / YELLOW / CYAN / GREEN / MAGENTA / RED / BLUE / ?
VECTOR:COLOR:2MAP_S1	WHITE / YELLOW / CYAN / GREEN / MAGENTA / RED / BLUE / ?
VECTOR:COLOR:2MAP_S2	WHITE / YELLOW / CYAN / GREEN / MAGENTA / RED / BLUE / ?
VECTOR:INTEN:SCALE	-8 to 7 / ?
VECTOR:SCALE:COLOR	WHITE / YELLOW / CYAN / GREEN / MAGENTA / RED / BLUE / ?
VECTOR:SCALE:IQ	ON / OFF / ?
VECTOR:SCALE:VEC	AUTO / BT_601 / BT_709 / ?
VECTOR:GAIN:MAG	X1 / X5 / IQ / ?
VECTOR:GAIN:VAL	0.200 to 10.000 / ?
VECTOR:GAIN:VAR	CAL / VAR / ?



## 11. ETHERNET REMOTE CONTROL

Command	Parameter
VECTOR:LINE_SELECT	ON / ACH / BCH / BOTH / 2MAP_S1 / 2MAP_S2 / OFF / CINELITE / ?
VECTOR:LINE_SELECT:FIELD	FIELD1 / FIELD2 / FRAME / ?
VECTOR:LINE_NUMBER	1 to 1125 / ?
VECTOR:MARKER	ON / OFF / ?
VECTOR:MODE	VECTOR / 5BAR / ?
VECTOR:5BAR:SCALE	P / MV / ?
VECTOR:5BAR:SEQUENCE	GBR / RGB / ?
VECTOR:5BAR:Y:DATA	? (Return value: maximum Y value, minimum Y value) * For 3G-B (2map), use the "INPUT:STREAM" command to select the stream.
VECTOR:5BAR:G:DATA	? (Return value: maximum G value, minimum G value) * For 3G-B (2map), use the "INPUT:STREAM" command to select the stream.
VECTOR:5BAR:B:DATA	? (Return value: maximum B value, minimum B value) * For 3G-B (2map), use the "INPUT:STREAM" command to select the stream.
VECTOR:5BAR:R:DATA	? (Return value: maximum R value, minimum R value) * For 3G-B (2map), use the "INPUT:STREAM" command to select the stream.
VECTOR:5BAR:CMP:DATA	? (Return value: maximum CMP value, minimum CMP value) * For 3G-B (2map), use the "INPUT:STREAM" command to select the stream.
VECTOR:DISPLAY:SIMUL	MIX / TILE / ?
VECTOR:DISPLAY:2MAP	STREAM1 / STREAM2 / MIX / TILE / ?
VECTOR:DISPLAY:THUMBNAIL:AUDIO	ON / OFF / ?
VECTOR:DISPLAY:THUMBNAIL:PICTURE	ON / OFF / ?
VECTOR:DISPLAY:THUMBNAIL:HISTO	ON / OFF / ?
VECTOR:DISPLAY:THUMBNAIL:HISTO:FORM	LUMA / ALIGN / MIX / ?
VECTOR:DISPLAY:THUMBNAIL:HISTO:Y	ON / OFF / ?
VECTOR:DISPLAY:THUMBNAIL:HISTO:R	ON / OFF / ?
VECTOR:DISPLAY:THUMBNAIL:HISTO:G	ON / OFF / ?
VECTOR:DISPLAY:THUMBNAIL:HISTO:B	ON / OFF / ?
VECTOR:MATRIX	COMPONENT / COMPOSITE / ?
VECTOR:MATRIX:COMPOSITE:FORMAT	AUTO / NTSC / PAL / ?
VECTOR:MATRIX:COMPOSITE:SETUP	0P / 7.5P / ?
VECTOR:MATRIX:COLORBAR	100P / 75P / ?
PICTURE	None
PICTURE:MONO_COLOR	MONO / COLOR / ?
PICTURE:CHROMA_UP	NORMAL / UP / ?

## 11. ETHERNET REMOTE CONTROL

Command	Parameter
PICTURE:BRIGHTNESS	-50.0 to 50.0 / ?
PICTURE:CONTRAST	0.0 to 200.0 / ?
PICTURE:GAIN:R	0.0 to 200.0 / ?
PICTURE:GAIN:G	0.0 to 200.0 / ?
PICTURE:GAIN:B	0.0 to 200.0 / ?
PICTURE:GAIN:CHROMA	0.0 to 200.0 / ?
PICTURE:BIAS:R	-50.0 to 50.0 / ?
PICTURE:BIAS:G	-50.0 to 50.0 / ?
PICTURE:BIAS:B	-50.0 to 50.0 / ?
PICTURE:MARKER:FRAME	ON / OFF / ?
PICTURE:MARKER:CENTER	ON / OFF / ?
PICTURE:MARKER:ASPECT	OFF / 14_9 / 13_9 / 16_9 / 4_3 / 2.39_1 / AFD / ?
PICTURE:MARKER:ASPECT:SHADOW	0 to 100 / ?
PICTURE:MARKER:SAFETY:ACTION	ARIB / SMPTE / USER1 / OFF / ?
PICTURE:MARKER:SAFETY:TITLE	ARIB / SMPTE / USER2 / OFF / ?
PICTURE:MARKER:SAFETY:USER1_W	0 to 100 / ?
PICTURE:MARKER:SAFETY:USER1_H	0 to 100 / ?
PICTURE:MARKER:SAFETY:USER2_W	0 to 100 / ?
PICTURE:MARKER:SAFETY:USER2_H	0 to 100 / ?
PICTURE:LINE_SELECT	ON / ACH / BCH / BOTH / 2MAP_S1 / 2MAP_S2 / OFF / ?
PICTURE:LINE_SELECT:FIELD	FIELD1 / FIELD2 / FRAME / ?
PICTURE:LINE_NUMBER	1 to 1125 / ?
PICTURE:CINELITE:MODE	OFF / FSTOP / PERCENT / CINEZONE
PICTURE:CINELITE:FD_FUNC	LINE / SAMPLE / ?
PICTURE:CINELITE:MEAS_POS	P1 / P2 / P3 / ?
PICTURE:CINELITE:MEAS_SIZE	1X1 / 3X3 / 9X9 / ?
PICTURE:CINELITE:LINE	1 to 1125 / ?
PICTURE:CINELITE:SAMPLE	0 to 2749 / ?
PICTURE:CINELITE:FSTOP:18P_REFSET	None
PICTURE:CINELITE:FSTOP:GAMMA_SEL	0.45 / USER1 / USER2 / USER3 / USER_A / USER_B / USER_C / USER_D / USER_E / ?
PICTURE:CINELITE:PERCENT:UNIT	Y_P / RGB_P / RGB_255 / ?
PICTURE:CINELITE:DATA	? (Return value: data at the current position)
PICTURE:CINELITE:CINEZONE:FORM	GRADATE / STEP / SEARCH / ?
PICTURE:CINELITE:CINEZONE:UPPER	-6.3 to 109.4 / ?
PICTURE:CINELITE:CINEZONE:LOWER	-7.3 to 108.4 / ?
PICTURE:CINELITE:CINEZONE:LEVEL	-7.3 to 109.4 / ?
PICTURE:CINELITE:ADVANCE	OFF / P_V / P_W / P_V_W / ?
PICTURE:DISPLAY:SIZE	FIT / REAL / X2 / FULL_FRM / ?
PICTURE:DISPLAY:GAMUT_ERR	OFF / WHITE / RED / MESH / ?
PICTURE:DISPLAY:MODE	2D / 3D_ASIST / ?
PICTURE:DISPLAY:SIMUL_DISP	MIX / TILE / ?
PICTURE:DISPLAY:2MAP_DISP	STREAM1 / STREAM2 / MIX / TILE / ?
PICTURE:DISPLAY:THUMBNAIL:AUDIO	ON / OFF / ?

11. ETHERNET REMOTE CONTROL

Command	Parameter
PICTURE:DISPLAY:THUMBNAIL:WFM	ON / OFF / ?
PICTURE:DISPLAY:THUMBNAIL:HISTO	ON / OFF / ?
PICTURE:DISPLAY:THUMBNAIL:HISTO:FORM	LUMA / ALIGN / MIX / ?
PICTURE:DISPLAY:THUMBNAIL:HISTO:Y	ON / OFF / ?
PICTURE:DISPLAY:THUMBNAIL:HISTO:R	ON / OFF / ?
PICTURE:DISPLAY:THUMBNAIL:HISTO:G	ON / OFF / ?
PICTURE:DISPLAY:THUMBNAIL:HISTO:B	ON / OFF / ?
PICTURE:DISPLAY:SD	4_3 / 16_9 / ?
PICTURE:S_IMPOSE:SMPTE	ON / OFF / ?
PICTURE:S_IMPOSE:FORMAT	FMT_608_708 / FMT_608_608 / FMT_VBI / FMT_708 / ?
PICTURE:S_IMPOSE:LANGUAGE_608	CC1 / CC2 / CC3 / CC4 / TEXT1 / TEXT2 / TEXT3 / TEXT4 / ?
PICTURE:S_IMPOSE:SERVICE_708	1 to 63 / ?
STATUS	None
STATUS:SIGNAL:DATA	? (Return value: DETECT / NO_SIGNAL)
STATUS:LINK:DATA	? (Return value: HD / SD / HD_DUAL / 3GA / 3GB / 3GB_2MAP / -)
STATUS:FORMAT:DATA	? (Return value: format / -)
STATUS:EMB_CH:DATA	? (Return value: audio channel / -) * For 3G-B (2map), use the "INPUT:STREAM" command to select the stream.
STATUS:LOG	None
STATUS:LOG:LOG	START / STOP / ?
STATUS:LOG:CLEAR	None
STATUS:LOG:LOG_MODE	OVER_WR / STOP / ?
STATUS:DUMP	None
STATUS:DUMP:MODE	RUN / HOLD / ?
STATUS:DUMP:DISPLAY	SERIAL / COMPONENT / BINARY / LINK_A / LINK_B / LINK_AB / S1_SERIAL / S1_COMPONENT / S1_BINARY / S2_SERIAL / S2_COMPONENT / S2_BINARY / ?
STATUS:DUMP:JUMP	EAV / SAV / ?
STATUS:DUMP:LINE_NUMBER	1 to 1125 / ?
STATUS:DUMP:SAMPLE	0 to 2749 / ?
STATUS:EXT_REF	None
STATUS:EXT_REF:USER_REF	None
STATUS:EXT_REF:DEFAULT	None
STATUS:EXT_REF:SELECT	EXT / CH_A / LINK_A / ?
STATUS:EXT_REF:REF:DATA	? (Return value: USER_REF / DEFAULT)
STATUS:EXT_REF:STAT:DATA	? (Return value: INT / ACH / LINK_A / HD / BB / NO_SIGNAL)
STATUS:EXT_REF:H_TIME:DATA	? (Return value: H PHASE[us])
STATUS:EXT_REF:H_PIX:DATA	? (Return value: H PHASE[pixel/dot])
STATUS:EXT_REF:V_LINE:DATA	? (Return value: V PHASE)

11. ETHERNET REMOTE CONTROL

Command	Parameter
STATUS:EXT_REF:TOTAL:DATA	? (Return value: TOTAL PHASE)
STATUS:AV_PHASE	None
STATUS:AV_PHASE:SCALE	50 / 100 / 500 / 1000 / 2500 / ?
STATUS:AV_PHASE:CH1:DATA	? (Return value: data / MISSING / UNLOCK / NO_SIGNAL / -)
STATUS:AV_PHASE:CH2:DATA	? (Return value: data / MISSING / UNLOCK / NO_SIGNAL / -)
STATUS:AV_PHASE:CH3:DATA	? (Return value: data / MISSING / UNLOCK / NO_SIGNAL / -)
STATUS:AV_PHASE:CH4:DATA	? (Return value: data / MISSING / UNLOCK / NO_SIGNAL / -)
STATUS:AV_PHASE:CH5:DATA	? (Return value: data / MISSING / UNLOCK / NO_SIGNAL / -)
STATUS:AV_PHASE:CH6:DATA	? (Return value: data / MISSING / UNLOCK / NO_SIGNAL / -)
STATUS:AV_PHASE:CH7:DATA	? (Return value: data / MISSING / UNLOCK / NO_SIGNAL / -)
STATUS:AV_PHASE:CH8:DATA	? (Return value: data / MISSING / UNLOCK / NO_SIGNAL / -)
STATUS:AV_PHASE:THUMB:AUDIO	ON / OFF / ?
STATUS:AV_PHASE:THUMB:PICTURE	ON / OFF / ?
STATUS:AV_PHASE:LINE	0 to 100 / ?
STATUS:AV_PHASE:LEFT	0 to 99 / ?
STATUS:AV_PHASE:RIGHT	0 to 99 / ?
STATUS:AV_PHASE:VIDEO	25 to 100 / ?
STATUS:AV_PHASE:AUDIO	-30 to 0 / ?
STATUS:AV_PHASE:MES:GATE	OFF / ON / ?
STATUS:AV_PHASE:MES:GATE:TIME	100 to 1500 / ?
STATUS:ANC_PACKET	None
STATUS:ANC_PACKET:AUDIO_CTRL:DATA	? (Return value: DETECT / MISSING / -)
STATUS:ANC_PACKET:EDH:DATA	? (Return value: DETECT / MISSING / -)
STATUS:ANC_PACKET:LTC:DATA	? (Return value: DETECT / MISSING / -)
STATUS:ANC_PACKET:VITC:DATA	? (Return value: DETECT / MISSING / -)
STATUS:ANC_PACKET:PAYLOAD1:DATA	? (Return value: DETECT / MISSING / -) * During HD dual link, the command applies to LINK A. During 3G-B(2map), the command applies to STREAM 1.
STATUS:ANC_PACKET:PAYLOAD2:DATA	? (Return value: DETECT / MISSING / -) * During HD dual link, the command applies to LINK B. During 3G-B(2map), the command applies to STREAM 2.
STATUS:ANC_PACKET:EIA708_708:DATA	? (Return value: DETECT / MISSING / -)
STATUS:ANC_PACKET:EIA708_608:DATA	? (Return value: DETECT / MISSING / -)
STATUS:ANC_PACKET:EIA608:DATA	? (Return value: DETECT / MISSING / -)
STATUS:ANC_PACKET:PROGRAM:DATA	? (Return value: DETECT / MISSING / -)

## 11. ETHERNET REMOTE CONTROL

Command	Parameter
STATUS:ANC_PACKET:DATA_BROADCAST:DATA	? (Return value: DETECT / MISSING / -)
STATUS:ANC_PACKET:VBI:DATA	? (Return value: DETECT / MISSING / -)
STATUS:ANC_PACKET:AFD:DATA	? (Return value: DETECT / MISSING / -)
STATUS:ANC_PACKET:JPN_CC1:DATA	? (Return value: DETECT / MISSING / -)
STATUS:ANC_PACKET:JPN_CC2:DATA	? (Return value: DETECT / MISSING / -)
STATUS:ANC_PACKET:JPN_CC3:DATA	? (Return value: DETECT / MISSING / -)
STATUS:ANC_PACKET:NET_Q:DATA	? (Return value: DETECT / MISSING / -)
STATUS:ANC_PACKET:TRIGGER:DATA	? (Return value: DETECT / MISSING / -)
STATUS:ANC_PACKET:USER1:DATA	? (Return value: DETECT / MISSING / -)
STATUS:ANC_PACKET:USER2:DATA	? (Return value: DETECT / MISSING / -)
STATUS:ANC:PKT:PAYLOAD_ID	None
STATUS:ANC:PKT:PAYLOAD_ID:STREAM	STRERAM1 / STREAM2 / ?
STATUS:ANC:PKT:PAYLOAD_ID:LINK	LINK_A / LINK_B / ?
STATUS:ANC:PKT:PAYLOAD_ID:DATA	? (Return value: 4-byte hexadecimal data / --,--,--,--)
STATUS:ANC:PKT:AUDIO_CTRL	None
STATUS:ANC:PKT:AUDIO_CTRL:DISPLAY	TEXT / DUMP / ?
STATUS:ANC:PKT:AUDIO_CTRL:MODE	HEX / BINARY / ?
STATUS:ANC:PKT:AUDIO_CTRL:GROUP	1 / 2 / 3 / 4 / ?
STATUS:ANC:PKT:AUDIO_CTRL:STREAM	STRERAM1 / STREAM2 / ?
STATUS:ANC:PKT:ARIB:NETQ	None
STATUS:ANC:PKT:ARIB:NETQ:BIT:Q1	ON / OFF / ?
STATUS:ANC:PKT:ARIB:NETQ:BIT:Q2	ON / OFF / ?
STATUS:ANC:PKT:ARIB:NETQ:BIT:Q3	ON / OFF / ?
STATUS:ANC:PKT:ARIB:NETQ:BIT:Q4	ON / OFF / ?
STATUS:ANC:PKT:ARIB:NETQ:BIT:Q5	ON / OFF / ?
STATUS:ANC:PKT:ARIB:NETQ:BIT:Q6	ON / OFF / ?
STATUS:ANC:PKT:ARIB:NETQ:BIT:Q7	ON / OFF / ?
STATUS:ANC:PKT:ARIB:NETQ:BIT:Q8	ON / OFF / ?
STATUS:ANC:PKT:ARIB:NETQ:BIT:Q9	ON / OFF / ?
STATUS:ANC:PKT:ARIB:NETQ:BIT:Q10	ON / OFF / ?
STATUS:ANC:PKT:ARIB:NETQ:BIT:Q11	ON / OFF / ?
STATUS:ANC:PKT:ARIB:NETQ:BIT:Q12	ON / OFF / ?
STATUS:ANC:PKT:ARIB:NETQ:BIT:Q13	ON / OFF / ?
STATUS:ANC:PKT:ARIB:NETQ:BIT:Q14	ON / OFF / ?
STATUS:ANC:PKT:ARIB:NETQ:BIT:Q15	ON / OFF / ?
STATUS:ANC:PKT:ARIB:NETQ:BIT:Q16	ON / OFF / ?
STATUS:ANC:PKT:ARIB:NETQ:BIT:Q17	ON / OFF / ?
STATUS:ANC:PKT:ARIB:NETQ:BIT:Q18	ON / OFF / ?
STATUS:ANC:PKT:ARIB:NETQ:BIT:Q19	ON / OFF / ?
STATUS:ANC:PKT:ARIB:NETQ:BIT:Q20	ON / OFF / ?
STATUS:ANC:PKT:ARIB:NETQ:BIT:Q21	ON / OFF / ?
STATUS:ANC:PKT:ARIB:NETQ:BIT:Q22	ON / OFF / ?
STATUS:ANC:PKT:ARIB:NETQ:BIT:Q23	ON / OFF / ?
STATUS:ANC:PKT:ARIB:NETQ:BIT:Q24	ON / OFF / ?

11. ETHERNET REMOTE CONTROL

Command	Parameter
STATUS:ANC:PKT:ARIB:NETQ:BIT:Q25	ON / OFF / ?
STATUS:ANC:PKT:ARIB:NETQ:BIT:Q26	ON / OFF / ?
STATUS:ANC:PKT:ARIB:NETQ:BIT:Q27	ON / OFF / ?
STATUS:ANC:PKT:ARIB:NETQ:BIT:Q28	ON / OFF / ?
STATUS:ANC:PKT:ARIB:NETQ:BIT:Q29	ON / OFF / ?
STATUS:ANC:PKT:ARIB:NETQ:BIT:Q30	ON / OFF / ?
STATUS:ANC:PKT:ARIB:NETQ:BIT:Q31	ON / OFF / ?
STATUS:ANC:PKT:ARIB:NETQ:BIT:Q32	ON / OFF / ?
STATUS:ANC:PKT:ARIB:NETQ:BIT:S1	ON / OFF / ?
STATUS:ANC:PKT:ARIB:NETQ:BIT:S2	ON / OFF / ?
STATUS:ANC:PKT:ARIB:NETQ:BIT:S3	ON / OFF / ?
STATUS:ANC:PKT:ARIB:NETQ:BIT:S4	ON / OFF / ?
STATUS:ANC:PKT:ARIB:NETQ:BIT:S5	ON / OFF / ?
STATUS:ANC:PKT:ARIB:NETQ:BIT:S6	ON / OFF / ?
STATUS:ANC:PKT:ARIB:NETQ:BIT:S7	ON / OFF / ?
STATUS:ANC:PKT:ARIB:NETQ:BIT:S8	ON / OFF / ?
STATUS:ANC:PKT:ARIB:NETQ:BIT:S9	ON / OFF / ?
STATUS:ANC:PKT:ARIB:NETQ:BIT:S10	ON / OFF / ?
STATUS:ANC:PKT:ARIB:NETQ:BIT:S11	ON / OFF / ?
STATUS:ANC:PKT:ARIB:NETQ:BIT:S12	ON / OFF / ?
STATUS:ANC:PKT:ARIB:NETQ:BIT:S13	ON / OFF / ?
STATUS:ANC:PKT:ARIB:NETQ:BIT:S14	ON / OFF / ?
STATUS:ANC:PKT:ARIB:NETQ:BIT:S15	ON / OFF / ?
STATUS:ANC:PKT:ARIB:NETQ:BIT:S16	ON / OFF / ?
STATUS:ANC:PKT:ARIB:NETQ:STATION:DATA	? (Return value: STATION CODE / -)
STATUS:ANC:PKT:ARIB:NETQ:V_CURR:DATA	? (Return value: VIDEO CURRENT / -)
STATUS:ANC:PKT:ARIB:NETQ:V_NEXT:DATA	? (Return value: VIDEO NEXT / -)
STATUS:ANC:PKT:ARIB:NETQ:A_CURR:DATA	? (Return value: AUDIO CURRENT / -)
STATUS:ANC:PKT:ARIB:NETQ:A_NEXT:DATA	? (Return value: AUDIO NEXT / -)
STATUS:ANC:PKT:ARIB:NETQ:D_CURR:DATA	? (Return value: DOWN MIX CURRENT / -)
STATUS:ANC:PKT:ARIB:NETQ:D_NEXT:DATA	? (Return value: DOWN MIX NEXT / -)
STATUS:ANC:PKT:SMPTE:AFD	None
STATUS:ANC:PKT:SMPTE:AFD:CODE:DATA	? (Return value: AFD CODE / -)
STATUS:ANC:PKT:SMPTE:AFD:FRAME:DATA	? (Return value: CODED FRAME / -)
STATUS:ANC:PKT:SMPTE:AFD:BAR_FLG:DATA	? (Return value: BAR DATA FLAGS / -)
STATUS:ANC:PKT:SMPTE:AFD:BAR_VAL1:DATA	? (Return value: BAR DATA VALUE1 / -)
STATUS:ANC:PKT:SMPTE:AFD:BAR_VAL2:DATA	? (Return value: BAR DATA VALUE2 / -)
STATUS:ERROR:SDI:COUNTER	SEC / FIELD / ?
STATUS:ERROR:SDI:TRS	ON / OFF / ?
STATUS:ERROR:SDI:HD_LINE	ON / OFF / ?
STATUS:ERROR:SDI:HD_CRC	ON / OFF / ?
STATUS:ERROR:SDI:SD_EDH	ON / OFF / ?
STATUS:ERROR:SDI:ILLEGAL_CODE	ON / OFF / ?
STATUS:ERROR:ANC:PARITY	ON / OFF / ?
STATUS:ERROR:ANC:CHECKSUM	ON / OFF / ?

11. ETHERNET REMOTE CONTROL

Command	Parameter
STATUS:ERROR:AUDIO:BCH	ON / OFF / ?
STATUS:ERROR:AUDIO:DBN	ON / OFF / ?
STATUS:ERROR:AUDIO:PARITY	ON / OFF / ?
STATUS:ERROR:AUDIO:INHIBIT	ON / OFF / ?
STATUS:ERROR:AUDIO:SAMPLE	ON / OFF / ?
STATUS:ERROR:GAMUT:LPF	HD1M_SD1M / HD2.8M_SD1M / OFF / ?
STATUS:ERROR:GAMUT	ON / OFF / ?
STATUS:ERROR:GAMUT:UPPER	90.8 to 109.4 / ?
STATUS:ERROR:GAMUT:LOWER	-7.2 to 6.1 / ?
STATUS:ERROR:GAMUT:AREA	0.0 to 5.0 / ?
STATUS:ERROR:GAMUT:DURATION	1 to 60 / ?
STATUS:ERROR:C_GAMUT	ON / OFF / ?
STATUS:ERROR:C_GAMUT:SETUP	0% / 7.5% / ?
STATUS:ERROR:C_GAMUT:UPPER	90.0 to 135.0 / ?
STATUS:ERROR:C_GAMUT:LOWER	-40.0 to 20.0 / ?
STATUS:ERROR:C_GAMUT:AREA	0.0 to 5.0 / ?
STATUS:ERROR:C_GAMUT:DURATION	1 to 60 / ?
STATUS:ERROR:FREEZE	ON / OFF / ?
STATUS:ERROR:FREEZE:UPPER	0 to 100 / ?
STATUS:ERROR:FREEZE:LOWER	0 to 100 / ?
STATUS:ERROR:FREEZE:LEFT	0 to 100 / ?
STATUS:ERROR:FREEZE:RIGHT	0 to 100 / ?
STATUS:ERROR:FREEZE:DURATION	2 to 300 / ?
STATUS:ERROR:BLACK	ON / OFF / ?
STATUS:ERROR:BLACK:LEVEL	0 to 100 / ?
STATUS:ERROR:BLACK:AREA	1 to 100 / ?
STATUS:ERROR:BLACK:DURATION	1 to 300 / ?
STATUS:ERROR:LEVEL	ON / OFF / ?
STATUS:ERROR:LEVEL:RUMA:UPPER	-51 to 766 / ?
STATUS:ERROR:LEVEL:RUMA:LOWER	-51 to 766 / ?
STATUS:ERROR:LEVEL:CHROMA:UPPER	-400 to 399 / ?
STATUS:ERROR:LEVEL:CHROMA:LOWER	-400 to 399 / ?
STATUS:ERROR:CLEAR	None

Table 11-3 LV 5770SER09A commands

Command	Parameter
STATUS:ERROR:SDI:CABLE	ON / OFF / ?
STATUS:ERROR:SDI:CABLE_3G	LS-5CFB / 1694A / ?
STATUS:ERROR:SDI:CABLE_HD	LS-5CFB / 1694A / ?
STATUS:ERROR:SDI:CABLE_SD	L-5C2V / 8281 / ?
STATUS:ERROR:SDI:CABLE_ERR_3G	10 to 105 / ?
STATUS:ERROR:SDI:CABLE_WAR_3G	10 to 105 / ?
STATUS:ERROR:SDI:CABLE_ERR_HD	5 to 130 / ?
STATUS:ERROR:SDI:CABLE_WAR_HD	5 to 130 / ?
STATUS:ERROR:SDI:CABLE_ERR_SD	50 to 300 / ?

## 11. ETHERNET REMOTE CONTROL

Command	Parameter
STATUS:ERROR:SDI:CABLE_WAR_SD	50 to 300 / ?
EYE	None
EYE:MODE	EYE / JITTER / ?
EYE:INTEN:EYE	-128 to 127 / ?
EYE:INTEN:SCALE	-8 to 7 / ?
EYE:COLOR:EYE	WHITE / YELLOW / CYAN / GREEN / MAGENTA / RED / BLUE / ?
EYE:COLOR:SCALE	WHITE / YELLOW / CYAN / GREEN / MAGENTA / RED / BLUE / ?
EYE:GAIN:VAR	CAL / VARIABLE / ?
EYE:GAIN:VAL	0.50 to 2.00 / ?
EYE:SWEEP:SWEEP	2UI / 4UI / 16UI / ?
EYE:FILTER	100KHZ / 1KHZ / 100HZ / 10HZ / TIMING / ALIGNMENT / ?
EYE:SUB_ITEM	JITTER / OFF / ?
EYE:LINK_SELECT	LINK_A / LINK_B / ?
EYE:JITTER:INTEN	-8 to 7 / ?
EYE:JITTER:INTEN:SCALE	-8 to 7 / ?
EYE:JITTER:COLOR	WHITE / YELLOW / CYAN / GREEN / MAGENTA / RED / BLUE / ?
EYE:JITTER:COLOR:SCALE	WHITE / YELLOW / CYAN / GREEN / MAGENTA / RED / BLUE / ?
EYE:JITTER:GAIN	X1 / X2 / X8 / ?
EYE:JITTER:SWEEP	1H / 2H / 1V / 2V / ?
EYE:JITTER:FILTER	100KHZ / 1KHZ / 100HZ / 10HZ / TIMING / ALIGNMENT / ?
EYE:JITTER:PEAK_HOLD	ON / OFF / ?
EYE:JITTER:PEAK_HOLD_CLEAR	None
EYE:JITTER:SUB_ITEM	EYE / OFF / ?
EYE:ERROR:3G:AMP	ON / OFF / ?
EYE:ERROR:3G:AMP:UPPER	80 to 140 / ?
EYE:ERROR:3G:AMP:LOWER	40 to 100 / ?
EYE:ERROR:3G:RISE	ON / OFF / ?
EYE:ERROR:3G:RISE:MAX	40 to 140 / ?
EYE:ERROR:3G:FALL	ON / OFF / ?
EYE:ERROR:3G:FALL:MAX	40 to 140 / ?
EYE:ERROR:3G:DELTA	ON / OFF / ?
EYE:ERROR:3G:DELTA:MAX	40 to 140 / ?
EYE:ERROR:3G:TIMING_JIT	ON / OFF / ?
EYE:ERROR:3G:TIMING_JIT:MAX	10 to 200 / ?
EYE:ERROR:3G:CURRENT_JIT	ON / OFF / ?
EYE:ERROR:3G:CURRENT_JIT:MAX	10 to 200 / ?
EYE:ERROR:3G:OVERSHOOT_RISE	ON / OFF / ?
EYE:ERROR:3G:OVERSHOOT_RISE:MAX	0 to 200 / ?
EYE:ERROR:3G:OVERSHOOT_FALL	ON / OFF / ?



## 11. ETHERNET REMOTE CONTROL

Command	Parameter
EYE:ERROR:3G:OVERSHOOT_FALL:MAX	0 to 200 / ?
EYE:ERROR:HD:AMPLITUDE	ON / OFF / ?
EYE:ERROR:HD:AMPLITUDE:UPPER	80 to 140 / ?
EYE:ERROR:HD:AMPLITUDE:LOWER	40 to 100 / ?
EYE:ERROR:HD:RISETIME	ON / OFF / ?
EYE:ERROR:HD:RISETIME:MAX	40 to 140 / ?
EYE:ERROR:HD:FALLTIME	ON / OFF / ?
EYE:ERROR:HD:FALLTIME:MAX	40 to 140 / ?
EYE:ERROR:HD:DELTATIME	ON / OFF / ?
EYE:ERROR:HD:DELTATIME:MAX	40 to 140 / ?
EYE:ERROR:HD:TIMING_JITTER	ON / OFF / ?
EYE:ERROR:HD:TIMING_JITTER:MAX	10 to 200 / ?
EYE:ERROR:HD:CURRENT_JITTER	ON / OFF / ?
EYE:ERROR:HD:CURRENT_JITTER:MAX	10 to 200 / ?
EYE:ERROR:HD:OVERSHOOT:RISE	ON / OFF / ?
EYE:ERROR:HD:OVERSHOOT:RISE:MAX	0 to 200 / ?
EYE:ERROR:HD:OVERSHOOT:FALL	ON / OFF / ?
EYE:ERROR:HD:OVERSHOOT:FALL:MAX	0 to 200 / ?
EYE:ERROR:SD:AMPLITUDE	ON / OFF / ?
EYE:ERROR:SD:AMPLITUDE:UPPER	80 to 140 / ?
EYE:ERROR:SD:AMPLITUDE:LOWER	40 to 100 / ?
EYE:ERROR:SD:RISETIME	ON / OFF / ?
EYE:ERROR:SD:RISETIME:MAX	40 to 140 / ?
EYE:ERROR:SD:FALLTIME	ON / OFF / ?
EYE:ERROR:SD:FALLTIME:MAX	40 to 140 / ?
EYE:ERROR:SD:DELTATIME	ON / OFF / ?
EYE:ERROR:SD:DELTATIME:MAX	40 to 140 / ?
EYE:ERROR:SD:TIMING_JITTER	ON / OFF / ?
EYE:ERROR:SD:TIMING_JITTER:MAX	10 to 200 / ?
EYE:ERROR:SD:CURRENT_JITTER	ON / OFF / ?
EYE:ERROR:SD:CURRENT_JITTER:MAX	10 to 200 / ?
EYE:ERROR:SD:OVERSHOOT:RISE	ON / OFF / ?
EYE:ERROR:SD:OVERSHOOT:RISE:MAX	0 to 200 / ?
EYE:ERROR:SD:OVERSHOOT:FALL	ON / OFF / ?
EYE:ERROR:SD:OVERSHOOT:FALL:MAX	0 to 200 / ?
EYE:DC:OFFSET	ON / OFF / ?
EYE:DC:UPPER	0 to 100 / ?
EYE:DC:LOWER	0 to 100 / ?
EYE:AMP:DATA	? (Return value: Amp)
EYE:TR:DATA	? (Return value: Tr)
EYE:TF:DATA	? (Return value: Tf)
EYE:TJ:DATA	? (Return value: T.J)
EYE:CJ:DATA	? (Return value: C.J)
EYE:OR:DATA	? (Return value: Or)
EYE:OF:DATA	? (Return value: Of)

11. ETHERNET REMOTE CONTROL

Table 11-4 LV 5770SER03A commands

Command	Parameter
WFM	None
WFM:INTEN:WFM	-128 to 127 / ?
WFM:COLOR	WHITE / YELLOW / CYAN / GREEN / MAGENTA / RED / BLUE / MULTI / ?
WFM:INTEN:SCALE	-8 to 7 / ?
WFM:SCALE:COLOR	WHITE / YELLOW / CYAN / GREEN / MAGENTA / RED / BLUE / ?
WFM:GAIN:VAR	CAL / VAR / ?
WFM:GAIN:VAL	0.200 to 2.000 / ?
WFM:GAIN:MAG	X1 / X5 / ?
WFM:FILTER	FLAT / LOWPASS / ?
WFM:SWEEP:SWEEP	H / V / ?
WFM:SWEEP:H_SWEEP	1H / 2H / ?
WFM:SWEEP:V_SWEEP	1V / 2V / ?
WFM:SWEEP:H_MAG	X1 / X10 / X20 / ?
WFM:SWEEP:V_MAG	X1 / X20 / X40 / ?
WFM:SWEEP:FIELD	FIELD1 / FIELD2 / ?
WFM:LINE_SELECT	ON / OFF / ?
WFM:LINE_SELECT:FIELD	FIELD1 / FIELD2 / FRAME / ?
WFM:LINE_NUMBER	1 to 1125 / ?
WFM:DISPLAY:THUMBNAIL:AUDIO	ON / OFF / ?
WFM:DISPLAY:THUMBNAIL:PICTURE	ON / OFF / ?
WFM:DISPLAY:THUMBNAIL:HISTO	ON / OFF / ?
WFM:DISPLAY:THUMBNAIL:HISTO:FORM	LUMA / ALIGN / MIX / ?
WFM:DISPLAY:THUMBNAIL:HISTO:Y	ON / OFF / ?
WFM:DISPLAY:THUMBNAIL:HISTO:R	ON / OFF / ?
WFM:DISPLAY:THUMBNAIL:HISTO:G	ON / OFF / ?
WFM:DISPLAY:THUMBNAIL:HISTO:B	ON / OFF / ?
VECTOR	None
VECTOR:INTEN:VECTOR	-128 to 127 / ?
VECTOR:COLOR	WHITE / YELLOW / CYAN / GREEN / MAGENTA / RED / BLUE / ?
VECTOR:INTEN:SCALE	-8 to 7 / ?
VECTOR:SCALE:COLOR	WHITE / YELLOW / CYAN / GREEN / MAGENTA / RED / BLUE / ?
VECTOR:SCALE:IQ	ON / OFF / ?
VECTOR:GAIN:MAG	X1 / X5 / IQ / ?
VECTOR:GAIN:VAL	0.200 to 10.000 / ?
VECTOR:GAIN:VAR	CAL / VAR / ?
VECTOR:LINE_SELECT	ON / OFF / ?
VECTOR:LINE_SELECT:FIELD	FIELD1 / FIELD2 / FRAME / ?
VECTOR:LINE_NUMBER	1 to 625 / ?
VECTOR:DISPLAY:SCH	ON / OFF / ?

## 11. ETHERNET REMOTE CONTROL

Command	Parameter
VECTOR:DISPLAY:SCH:DATA	? (Return value: SCH)
VECTOR:DISPLAY:THUMBNAIL:AUDIO	ON / OFF / ?
VECTOR:DISPLAY:THUMBNAIL:PICTURE	ON / OFF / ?
VECTOR:DISPLAY:THUMBNAIL:HISTO	ON / OFF / ?
VECTOR:DISPLAY:THUMBNAIL:HISTO:FORM	LUMA / ALIGN / MIX / ?
VECTOR:DISPLAY:THUMBNAIL:HISTO:Y	ON / OFF / ?
VECTOR:DISPLAY:THUMBNAIL:HISTO:R	ON / OFF / ?
VECTOR:DISPLAY:THUMBNAIL:HISTO:G	ON / OFF / ?
VECTOR:DISPLAY:THUMBNAIL:HISTO:B	ON / OFF / ?
VECTOR:MATRIX:SETUP	0P / 7.5P / ?
VECTOR:MATRIX:COLORBAR	100P / 75P / ?
VECTOR:MATRIX:NTSC_DISP	ON / OFF / ?
VECTOR:PHASE	0.0 to 359.9
VECTOR:POS:H	-130 to +130
VECTOR:POS:V	-130 to +130
PICTURE	None
PICTURE:MONO_COLOR	MONO / COLOR / ?
PICTURE:CHROMA_UP	NORMAL / UP / ?
PICTURE:BRIGHTNESS	-50.0 to 50.0 / ?
PICTURE:CONTRAST	0.0 to 200.0 / ?
PICTURE:GAIN:R	0.0 to 200.0 / ?
PICTURE:GAIN:G	0.0 to 200.0 / ?
PICTURE:GAIN:B	0.0 to 200.0 / ?
PICTURE:GAIN:CHROMA	0.0 to 200.0 / ?
PICTURE:BIAS:R	-50.0 to 50.0 / ?
PICTURE:BIAS:G	-50.0 to 50.0 / ?
PICTURE:BIAS:B	-50.0 to 50.0 / ?
PICTURE:MARKER:FRAME	ON / OFF / ?
PICTURE:MARKER:CENTER	ON / OFF / ?
PICTURE:MARKER:ASPECT	OFF / 16_9 / 14_9 / 13_9 / ?
PICTURE:MARKER:ASPECT:SHADOW	0 to 100 / ?
PICTURE:MARKER:SAFETY:ACTION	SMPTE / USER1 / OFF / ?
PICTURE:MARKER:SAFETY:TITLE	SMPTE / USER2 / OFF / ?
PICTURE:MARKER:SAFETY:USER1_W	0 to 100 / ?
PICTURE:MARKER:SAFETY:USER1_H	0 to 100 / ?
PICTURE:MARKER:SAFETY:USER2_W	0 to 100 / ?
PICTURE:MARKER:SAFETY:USER2_H	0 to 100 / ?
PICTURE:LINE_SELECT	ON / OFF / ?
PICTURE:LINE_SELECT:FIELD	FIELD1 / FIELD2 / FRAME / ?
PICTURE:LINE_NUMBER	1 to 625 / ?
PICTURE:DISPLAY:SIZE	FIT / REAL / X2 / FULL_FRM / ?
PICTURE:DISPLAY:THUMBNAIL:AUDIO	ON / OFF / ?
PICTURE:DISPLAY:THUMBNAIL:WFM	ON / OFF / ?
PICTURE:DISPLAY:THUMBNAIL:HISTO	ON / OFF / ?
PICTURE:DISPLAY:THUMBNAIL:HISTO:FORM	LUMA / ALIGN / MIX / ?

11. ETHERNET REMOTE CONTROL

Command	Parameter
PICTURE:DISPLAY:THUMBNAIL:HISTO:Y	ON / OFF / ?
PICTURE:DISPLAY:THUMBNAIL:HISTO:R	ON / OFF / ?
PICTURE:DISPLAY:THUMBNAIL:HISTO:G	ON / OFF / ?
PICTURE:DISPLAY:THUMBNAIL:HISTO:B	ON / OFF / ?
STATUS	None
STATUS:EXT_REF	None
STATUS:EXT_REF:USER_REF	None
STATUS:EXT_REF:DEFAULT	None
STATUS:EXT_REF:REF:DATA	? (Return value: USER_REF / DEFAULT)
STATUS:EXT_REF:STAT:DATA	? (Return value: INT / HD / BB / NO_SIGNAL)
STATUS:EXT_REF:H_TIME:DATA	? (Return value: H PHASE[us])
STATUS:EXT_REF:H_PIX:DATA	? (Return value: H PHASE[pixel])
STATUS:EXT_REF:V_LINE:DATA	? (Return value: V PHASE)
STATUS:EXT_REF:TOTAL:DATA	? (Return value: TOTAL PHASE)

Table 11-5 LV 5770SER41, LV 5770SER42, and LV 5770SER43 commands

Command	Parameter
AUDIO:SOURCE:INPUT	SDI / EXT_DIGI / EXT_ANA / ?
AUDIO:SOURCE:SDI:1ST_GRP	1 / 2 / 3 / 4 / ?
AUDIO:SOURCE:SDI:2ND_GRP	1 / 2 / 3 / 4 / ?
AUDIO:SOURCE:EXT_DIGI:CH_SEL	GRP_A / GRP_B / ?
AUDIO:NUMBER	8CH / 16CH / ?
AUDIO:DISPLAY_MODE	LISSAJOU / METER / SURROUND / STATUS / LOUDNESS / ?
AUDIO:METER:D_RANGE	M60DBFS / M90DBFS / MAG / ?
AUDIO:METER:RESPONSE	TRUE_PEAK / PPM / VU / ?
AUDIO:METER:RESPONSE:PPM	PPM1 / PPM2 / ?
AUDIO:METER:RESPONSE:VU	TRUE / PPM1 / PPM2 / ?
AUDIO:METER:PEAK_HOLD	0.5 / 1.0 / 1.5 / 2.0 / 2.5 / 3.0 / 3.5 / 4.0 / 4.5 / 5.0 / HOLD / ?
AUDIO:METER:OVER_LEVEL	-40.0 to 0.0 / ?
AUDIO:METER:WARNING_LEVEL	-40.0 to 0.0 / ?
AUDIO:METER:REF_LEVEL	-40.0 to 0.0 / ?
AUDIO:LISSAJOU:INTEN:LISSAJOU	-8 to 7 / ?
AUDIO:LISSAJOU:INTEN:SCALE	-8 to 7 / ?
AUDIO:LISSAJOU:DISPLAY	MULTI / SINGLE / ?
AUDIO:LISSAJOU:FORM	X-Y / MATRIX / ?
AUDIO:LISSAJOU:AUTO_GAIN	ON / OFF / ?
AUDIO:LISSAJOU:MAP:SINGLE:L	CH1 / CH2 / CH3 / CH4 / CH5 / CH6 / CH7 / CH8 / CH9 / CH10 / CH11 / CH12 / CH13 / CH14 / CH15 / CH16 / LT / ?
AUDIO:LISSAJOU:MAP:SINGLE:R	CH1 / CH2 / CH3 / CH4 / CH5 / CH6 / CH7 / CH8 / CH9 / CH10 / CH11 / CH12 / CH13 / CH14 / CH15 / CH16 / RT / ?
AUDIO:LISSAJOU:MAP:SINGLE_16_L	CH1 / CH2 / CH3 / CH4 / CH5 / CH6 / CH7 / CH8 /

## 11. ETHERNET REMOTE CONTROL

Command	Parameter
	CH9 / CH10 / CH11 / CH12 / CH13 / CH14 / CH15 / CH16 / LT / ?
AUDIO:LISSAJOU:MAP:SINGLE_16_R	CH1 / CH2 / CH3 / CH4 / CH5 / CH6 / CH7 / CH8 / CH9 / CH10 / CH11 / CH12 / CH13 / CH14 / CH15 / CH16 / RT / ?
AUDIO:LISSAJOU:MAP:SINGLE_MIX_L	CH1 / CH2 / CH3 / CH4 / CH5 / CH6 / CH7 / CH8 / LT / D1 / D2 / D3 / D4 / D5 / D6 / D7 / D8 / ?
AUDIO:LISSAJOU:MAP:SINGLE_MIX_R	CH1 / CH2 / CH3 / CH4 / CH5 / CH6 / CH7 / CH8 / RT / D1 / D2 / D3 / D4 / D5 / D6 / D7 / D8 / ?
AUDIO:LISSAJOU:MAP:MULTI:L1	CH1 / CH2 / CH3 / CH4 / CH5 / CH6 / CH7 / CH8 / CH9 / CH10 / CH11 / CH12 / CH13 / CH14 / CH15 / CH16 / ?
AUDIO:LISSAJOU:MAP:MULTI:R1	CH1 / CH2 / CH3 / CH4 / CH5 / CH6 / CH7 / CH8 / CH9 / CH10 / CH11 / CH12 / CH13 / CH14 / CH15 / CH16 / ?
AUDIO:LISSAJOU:MAP:MULTI:L2	CH1 / CH2 / CH3 / CH4 / CH5 / CH6 / CH7 / CH8 / CH9 / CH10 / CH11 / CH12 / CH13 / CH14 / CH15 / CH16 / ?
AUDIO:LISSAJOU:MAP:MULTI:R2	CH1 / CH2 / CH3 / CH4 / CH5 / CH6 / CH7 / CH8 / CH9 / CH10 / CH11 / CH12 / CH13 / CH14 / CH15 / CH16 / ?
AUDIO:LISSAJOU:MAP:MULTI:L3	CH1 / CH2 / CH3 / CH4 / CH5 / CH6 / CH7 / CH8 / CH9 / CH10 / CH11 / CH12 / CH13 / CH14 / CH15 / CH16 / ?
AUDIO:LISSAJOU:MAP:MULTI:R3	CH1 / CH2 / CH3 / CH4 / CH5 / CH6 / CH7 / CH8 / CH9 / CH10 / CH11 / CH12 / CH13 / CH14 / CH15 / CH16 / ?
AUDIO:LISSAJOU:MAP:MULTI:L4	CH1 / CH2 / CH3 / CH4 / CH5 / CH6 / CH7 / CH8 / CH9 / CH10 / CH11 / CH12 / CH13 / CH14 / CH15 / CH16 / ?
AUDIO:LISSAJOU:MAP:MULTI:R4	CH1 / CH2 / CH3 / CH4 / CH5 / CH6 / CH7 / CH8 / CH9 / CH10 / CH11 / CH12 / CH13 / CH14 / CH15 / CH16 / ?
AUDIO:LISSAJOU:MAP:MULTI16_L1	CH1 / CH2 / CH3 / CH4 / CH5 / CH6 / CH7 / CH8 / CH9 / CH10 / CH11 / CH12 / CH13 / CH14 / CH15 / CH16 / ?
AUDIO:LISSAJOU:MAP:MULTI16_R1	CH1 / CH2 / CH3 / CH4 / CH5 / CH6 / CH7 / CH8 / CH9 / CH10 / CH11 / CH12 / CH13 / CH14 / CH15 / CH16 / ?
AUDIO:LISSAJOU:MAP:MULTI16_L2	CH1 / CH2 / CH3 / CH4 / CH5 / CH6 / CH7 / CH8 / CH9 / CH10 / CH11 / CH12 / CH13 / CH14 / CH15 / CH16 / ?
AUDIO:LISSAJOU:MAP:MULTI16_R2	CH1 / CH2 / CH3 / CH4 / CH5 / CH6 / CH7 / CH8 / CH9 / CH10 / CH11 / CH12 / CH13 / CH14 / CH15 / CH16 / ?
AUDIO:LISSAJOU:MAP:MULTI16_L3	CH1 / CH2 / CH3 / CH4 / CH5 / CH6 / CH7 / CH8 /

11. ETHERNET REMOTE CONTROL

Command	Parameter
	CH9 / CH10 / CH11 / CH12 / CH13 / CH14 / CH15 / CH16 / ?
AUDIO:LISSAJOU:MAP:MULTI16_R3	CH1 / CH2 / CH3 / CH4 / CH5 / CH6 / CH7 / CH8 / CH9 / CH10 / CH11 / CH12 / CH13 / CH14 / CH15 / CH16 / ?
AUDIO:LISSAJOU:MAP:MULTI16_L4	CH1 / CH2 / CH3 / CH4 / CH5 / CH6 / CH7 / CH8 / CH9 / CH10 / CH11 / CH12 / CH13 / CH14 / CH15 / CH16 / ?
AUDIO:LISSAJOU:MAP:MULTI16_R4	CH1 / CH2 / CH3 / CH4 / CH5 / CH6 / CH7 / CH8 / CH9 / CH10 / CH11 / CH12 / CH13 / CH14 / CH15 / CH16 / ?
AUDIO:LISSAJOU:MAP:MULTI16_L5	CH1 / CH2 / CH3 / CH4 / CH5 / CH6 / CH7 / CH8 / CH9 / CH10 / CH11 / CH12 / CH13 / CH14 / CH15 / CH16 / ?
AUDIO:LISSAJOU:MAP:MULTI16_R5	CH1 / CH2 / CH3 / CH4 / CH5 / CH6 / CH7 / CH8 / CH9 / CH10 / CH11 / CH12 / CH13 / CH14 / CH15 / CH16 / ?
AUDIO:LISSAJOU:MAP:MULTI16_L6	CH1 / CH2 / CH3 / CH4 / CH5 / CH6 / CH7 / CH8 / CH9 / CH10 / CH11 / CH12 / CH13 / CH14 / CH15 / CH16 / ?
AUDIO:LISSAJOU:MAP:MULTI16_R6	CH1 / CH2 / CH3 / CH4 / CH5 / CH6 / CH7 / CH8 / CH9 / CH10 / CH11 / CH12 / CH13 / CH14 / CH15 / CH16 / ?
AUDIO:LISSAJOU:MAP:MULTI16_L7	CH1 / CH2 / CH3 / CH4 / CH5 / CH6 / CH7 / CH8 / CH9 / CH10 / CH11 / CH12 / CH13 / CH14 / CH15 / CH16 / ?
AUDIO:LISSAJOU:MAP:MULTI16_R7	CH1 / CH2 / CH3 / CH4 / CH5 / CH6 / CH7 / CH8 / CH9 / CH10 / CH11 / CH12 / CH13 / CH14 / CH15 / CH16 / ?
AUDIO:LISSAJOU:MAP:MULTI16_L8	CH1 / CH2 / CH3 / CH4 / CH5 / CH6 / CH7 / CH8 / CH9 / CH10 / CH11 / CH12 / CH13 / CH14 / CH15 / CH16 / ?
AUDIO:LISSAJOU:MAP:MULTI16_R8	CH1 / CH2 / CH3 / CH4 / CH5 / CH6 / CH7 / CH8 / CH9 / CH10 / CH11 / CH12 / CH13 / CH14 / CH15 / CH16 / ?
AUDIO:LISSAJOU:MAP:DOLBY:MIX_L5	D1 / D2 / D3 / D4 / D5 / D6 / D7 / D8 / ?
AUDIO:LISSAJOU:MAP:DOLBY:MIX_R5	D1 / D2 / D3 / D4 / D5 / D6 / D7 / D8 / ?
AUDIO:LISSAJOU:MAP:DOLBY:MIX_L6	D1 / D2 / D3 / D4 / D5 / D6 / D7 / D8 / ?
AUDIO:LISSAJOU:MAP:DOLBY:MIX_R6	D1 / D2 / D3 / D4 / D5 / D6 / D7 / D8 / ?
AUDIO:LISSAJOU:MAP:DOLBY:MIX_L7	D1 / D2 / D3 / D4 / D5 / D6 / D7 / D8 / ?
AUDIO:LISSAJOU:MAP:DOLBY:MIX_R7	D1 / D2 / D3 / D4 / D5 / D6 / D7 / D8 / ?
AUDIO:LISSAJOU:MAP:DOLBY:MIX_L8	D1 / D2 / D3 / D4 / D5 / D6 / D7 / D8 / ?
AUDIO:LISSAJOU:MAP:DOLBY:MIX_R8	D1 / D2 / D3 / D4 / D5 / D6 / D7 / D8 / ?
AUDIO:SURROUND:INTEN:SURROUND	-8 to 7 / ?
AUDIO:SURROUND:INTEN:SCALE	-8 to 7 / ?

11. ETHERNET REMOTE CONTROL

Command	Parameter
AUDIO:SURROUND:5.1	NORMAL / PHANTOM / ?
AUDIO:SURROUND:AUTO_GAIN	ON / OFF / ?
AUDIO:SURROUND:MAP:L	CH1 / CH2 / CH3 / CH4 / CH5 / CH6 / CH7 / CH8 / CH9 / CH10 / CH11 / CH12 / CH13 / CH14 / CH15 / CH16 / ?
AUDIO:SURROUND:MAP:R	CH1 / CH2 / CH3 / CH4 / CH5 / CH6 / CH7 / CH8 / CH9 / CH10 / CH11 / CH12 / CH13 / CH14 / CH15 / CH16 / ?
AUDIO:SURROUND:MAP:C	CH1 / CH2 / CH3 / CH4 / CH5 / CH6 / CH7 / CH8 / CH9 / CH10 / CH11 / CH12 / CH13 / CH14 / CH15 / CH16 / ?
AUDIO:SURROUND:MAP:LFE	CH1 / CH2 / CH3 / CH4 / CH5 / CH6 / CH7 / CH8 / CH9 / CH10 / CH11 / CH12 / CH13 / CH14 / CH15 / CH16 / ?
AUDIO:SURROUND:MAP:LS	CH1 / CH2 / CH3 / CH4 / CH5 / CH6 / CH7 / CH8 / CH9 / CH10 / CH11 / CH12 / CH13 / CH14 / CH15 / CH16 / ?
AUDIO:SURROUND:MAP:RS	CH1 / CH2 / CH3 / CH4 / CH5 / CH6 / CH7 / CH8 / CH9 / CH10 / CH11 / CH12 / CH13 / CH14 / CH15 / CH16 / ?
AUDIO:SURROUND:MAP:LL	CH1 / CH2 / CH3 / CH4 / CH5 / CH6 / CH7 / CH8 / CH9 / CH10 / CH11 / CH12 / CH13 / CH14 / CH15 / CH16 / ?
AUDIO:SURROUND:MAP:RR	CH1 / CH2 / CH3 / CH4 / CH5 / CH6 / CH7 / CH8 / CH9 / CH10 / CH11 / CH12 / CH13 / CH14 / CH15 / CH16 / ?
AUDIO:STATUS:LOG	None
AUDIO:STATUS:LOG:LOG	START / STOP / ?
AUDIO:STATUS:LOG:CLEAR	None
AUDIO:STATUS:LOG:LOG_MODE	OVER_WR / STOP / ?
AUDIO:STATUS:DISPLAY:CH_STATUS	None
AUDIO:STATUS:CH_STATUS	CH1 / CH2 / CH3 / CH4 / CH5 / CH6 / CH7 / CH8 / CH9 / CH10 / CH11 / CH12 / CH13 / CH14 / CH15 / CH16 / A1 / A2 / A3 / A4 / A5 / A6 / A7 / A8 / A9 / A10 / A11 / A12 / A13 / A14 / A15 / A16 / B1 / B2 / B3 / B4 / B5 / B6 / B7 / B8 / B9 / B10 / B11 / B12 / B13 / B14 / B15 / B16 / ?
AUDIO:STATUS:CH_STATUS:ALIGN	LSB / MSB / ?
AUDIO:STATUS:DISPLAY:USER_BIT	None
AUDIO:STATUS:USER_BIT	CH1 / CH2 / CH3 / CH4 / CH5 / CH6 / CH7 / CH8 / CH9 / CH10 / CH11 / CH12 / CH13 / CH14 / CH15 / CH16 / A1 / A2 / A3 / A4 / A5 / A6 / A7 / A8 / A9 / A10 / A11 / A12 / A13 / A14 / A15 / A16 / B1 / B2 / B3 / B4 / B5 / B6 / B7 / B8 / B9 / B10 / B11

## 11. ETHERNET REMOTE CONTROL

Command	Parameter
	/ B12 / B13 / B14 / B15 / B16 / ?
AUDIO:STATUS:USER_BIT:ALIGN	LSB / MSB / ?
AUDIO:STATUS:ERROR:LEVEL_OVER	ON / OFF / ?
AUDIO:STATUS:ERROR:CLIP	ON / OFF / ?
AUDIO:STATUS:ERROR:CLIP:DURATION	1 to 100 / ?
AUDIO:STATUS:ERROR:MUTE	ON / OFF / ?
AUDIO:STATUS:ERROR:MUTE:DURATION	1 to 5000 / ?
AUDIO:STATUS:ERROR:PARITY	ON / OFF / ?
AUDIO:STATUS:ERROR:VALIDITY	ON / OFF / ?
AUDIO:STATUS:ERROR:CRC	ON / OFF / ?
AUDIO:STATUS:ERROR:CODE_VIOLATION	ON / OFF / ?
AUDIO:STATUS:ERROR_RESET	None
AUDIO:STATUS:LEVEL:CH1:DATA	? (Return value: level / -) * Levels of channels that are not displayed are not output.
AUDIO:STATUS:LEVEL:CH2:DATA	? (Return value: level / -)
AUDIO:STATUS:LEVEL:CH3:DATA	? (Return value: level / -)
AUDIO:STATUS:LEVEL:CH4:DATA	? (Return value: level / -)
AUDIO:STATUS:LEVEL:CH5:DATA	? (Return value: level / -)
AUDIO:STATUS:LEVEL:CH6:DATA	? (Return value: level / -)
AUDIO:STATUS:LEVEL:CH7:DATA	? (Return value: level / -)
AUDIO:STATUS:LEVEL:CH8:DATA	? (Return value: level / -)
AUDIO:STATUS:LEVEL:CH9:DATA	? (Return value: level / -)
AUDIO:STATUS:LEVEL:CH10:DATA	? (Return value: level / -)
AUDIO:STATUS:LEVEL:CH11:DATA	? (Return value: level / -)
AUDIO:STATUS:LEVEL:CH12:DATA	? (Return value: level / -)
AUDIO:STATUS:LEVEL:CH13:DATA	? (Return value: level / -)
AUDIO:STATUS:LEVEL:CH14:DATA	? (Return value: level / -)
AUDIO:STATUS:LEVEL:CH15:DATA	? (Return value: level / -)
AUDIO:STATUS:LEVEL:CH16:DATA	? (Return value: level / -)
AUDIO:STATUS:DOLBY:LOCATION_H:DATA	? (Return value: EMB Frame Location H)
AUDIO:STATUS:DOLBY:LOCATION_V:DATA	? (Return value: EMB Frame Location V)
AUDIO:STATUS:DOLBY:LOCATION_MODE:DATA	? (Return value: EMB Frame Location mode)
AUDIO:STATUS:DOLBY:LOCATION_E:DATA	? (Return value: AES Frame Location V)
AUDIO:LOUD:PERIOD	2MIN / 10MIN / 30MIN / 1HOUR / 2HOUR / 6HOUR / 12HOUR / 24HOUR / 32HOUR / ?
AUDIO:LOUD:CHART_CLEAR	None
AUDIO:LOUD:MEASURE	START / STOP / ?
AUDIO:LOUD:MAG	OFF / ON / ?
AUDIO:LOUD:INTEG:MODE	BS1770_2 / ARIB / EBU / ATSC / ?
AUDIO:LOUD:INTEG:LEVEL	? (Return value: TARGET LV)
AUDIO:LOUD:INTEG:BLK_SIZE	? (Return value: Block Size)
AUDIO:LOUD:INTEG:ABS_GATE	? (Return value: Abs Gating)
AUDIO:LOUD:INTEG:OVLP_SIZE	? (Return value: Overlap Size)
AUDIO:LOUD:INTEG:REL_GATE	? (Return value: Rel Gating)



## 11. ETHERNET REMOTE CONTROL

Command	Parameter
AUDIO:LOUD:INTEG:LFE_GAIN	ON / OFF / ?
AUDIO:LOUD:INTEG:LFE_GAIN:VALUE	0 to 10 / ?
AUDIO:LOUD:SHORT:AVRG_TIME	200 to 10000 / ? (100 ms steps)
AUDIO:LOUD:MOMENT:AVRG_TIME	200 to 10000 / ? (100 ms steps)
AUDIO:LOUD:RESPONSE	SHORTTERM / MOMENTARY / ?
AUDIO:LOUD:CHART	INTEGRATED / SHORTTERM / MOMENTARY / ?
AUDIO:LOUD:AUTO:TRIGGER	OFF / REMOTE / TIMECODE / MUTE / ?
AUDIO:LOUD:AUTO_START:H	0 to 23 / ?
AUDIO:LOUD:AUTO_START:M	0 to 59 / ?
AUDIO:LOUD:AUTO_START:S	0 to 59 / ?
AUDIO:LOUD:AUTO_END:H	0 to 23 / ?
AUDIO:LOUD:AUTO_END:M	0 to 59 / ?
AUDIO:LOUD:AUTO_END:S	0 to 59 / ?
AUDIO:LOUD:OVER	ON / OFF / ?
AUDIO:LOUD:RELATIVE	ON / OFF / ?
AUDIO:LOUD:MAP:MODE	MONO / STEREO / 5_1 / CUSTOM / ?
AUDIO:LOUD:MAP:MONO:L_R	CH1 / CH2 / CH3 / CH4 / CH5 / CH6 / CH7 / CH8 / CH9 / CH10 / CH11 / CH12 / CH13 / CH14 / CH15 / CH16 / ?
AUDIO:LOUD:MAP:STEREO:L	CH1 / CH2 / CH3 / CH4 / CH5 / CH6 / CH7 / CH8 / CH9 / CH10 / CH11 / CH12 / CH13 / CH14 / CH15 / CH16 / ?
AUDIO:LOUD:MAP:STEREO:R	CH1 / CH2 / CH3 / CH4 / CH5 / CH6 / CH7 / CH8 / CH9 / CH10 / CH11 / CH12 / CH13 / CH14 / CH15 / CH16 / ?
AUDIO:LOUD:MAP:5_1:L	CH1 / CH2 / CH3 / CH4 / CH5 / CH6 / CH7 / CH8 / CH9 / CH10 / CH11 / CH12 / CH13 / CH14 / CH15 / CH16 / ?
AUDIO:LOUD:MAP:5_1:R	CH1 / CH2 / CH3 / CH4 / CH5 / CH6 / CH7 / CH8 / CH9 / CH10 / CH11 / CH12 / CH13 / CH14 / CH15 / CH16 / ?
AUDIO:LOUD:MAP:5_1:C	CH1 / CH2 / CH3 / CH4 / CH5 / CH6 / CH7 / CH8 / CH9 / CH10 / CH11 / CH12 / CH13 / CH14 / CH15 / CH16 / ?
AUDIO:LOUD:MAP:5_1:LFE	CH1 / CH2 / CH3 / CH4 / CH5 / CH6 / CH7 / CH8 / CH9 / CH10 / CH11 / CH12 / CH13 / CH14 / CH15 / CH16 / ?
AUDIO:LOUD:MAP:5_1:LS	CH1 / CH2 / CH3 / CH4 / CH5 / CH6 / CH7 / CH8 / CH9 / CH10 / CH11 / CH12 / CH13 / CH14 / CH15 / CH16 / ?
AUDIO:LOUD:MAP:5_1:RS	CH1 / CH2 / CH3 / CH4 / CH5 / CH6 / CH7 / CH8 / CH9 / CH10 / CH11 / CH12 / CH13 / CH14 / CH15 / CH16 / ?
AUDIO:LOUD:MAP:CUSTOM:L	CH1 / CH2 / CH3 / CH4 / CH5 / CH6 / CH7 / CH8 / CH9 / CH10 / CH11 / CH12 / CH13 / CH14 / CH15

## 11. ETHERNET REMOTE CONTROL

Command	Parameter
	/ CH16 / NC / ?
AUDIO:LOUD:MAP:CUSTOM:R	CH1 / CH2 / CH3 / CH4 / CH5 / CH6 / CH7 / CH8 / CH9 / CH10 / CH11 / CH12 / CH13 / CH14 / CH15 / CH16 / NC / ?
AUDIO:LOUD:MAP:CUSTOM:C	CH1 / CH2 / CH3 / CH4 / CH5 / CH6 / CH7 / CH8 / CH9 / CH10 / CH11 / CH12 / CH13 / CH14 / CH15 / CH16 / NC / ?
AUDIO:LOUD:MAP:CUSTOM:LFE	CH1 / CH2 / CH3 / CH4 / CH5 / CH6 / CH7 / CH8 / CH9 / CH10 / CH11 / CH12 / CH13 / CH14 / CH15 / CH16 / NC / ?
AUDIO:LOUD:MAP:CUSTOM:LS	CH1 / CH2 / CH3 / CH4 / CH5 / CH6 / CH7 / CH8 / CH9 / CH10 / CH11 / CH12 / CH13 / CH14 / CH15 / CH16 / NC / ?
AUDIO:LOUD:MAP:CUSTOM:RS	CH1 / CH2 / CH3 / CH4 / CH5 / CH6 / CH7 / CH8 / CH9 / CH10 / CH11 / CH12 / CH13 / CH14 / CH15 / CH16 / NC / ?
AUDIO:LOUD:SHORTTERM:DATA:MAIN	? (Return value: SHORTTERM / -)
AUDIO:LOUD:INTEGRATED:DATA:MAIN	? (Return value: INTEGRATED / -)
AUDIO:LOUD:MOMENTARY:DATA:MAIN	? (Return value: MOMENTARY / -)
AUDIO:LOUD:SHORTTERM:DATA:SUB	? (Return value: SHORTTERM / -)
AUDIO:LOUD:INTEGRATED:DATA:SUB	? (Return value: INTEGRATED / -)
AUDIO:LOUD:MOMENTARY:DATA:SUB	? (Return value: MOMENTARY / -)
AUDIO:LOUD:MAP:SUB:MODE	OFF / MONO / STEREO / ?
AUDIO:LOUD:MAP:SUB:MONO:L_R	CH1 / CH2 / CH3 / CH4 / CH5 / CH6 / CH7 / CH8 / CH9 / CH10 / CH11 / CH12 / CH13 / CH14 / CH15 / CH16 / ?
AUDIO:LOUD:MAP:SUB:STEREO:L	CH1 / CH2 / CH3 / CH4 / CH5 / CH6 / CH7 / CH8 / CH9 / CH10 / CH11 / CH12 / CH13 / CH14 / CH15 / CH16 / ?
AUDIO:LOUD:MAP:SUB:STEREO:R	CH1 / CH2 / CH3 / CH4 / CH5 / CH6 / CH7 / CH8 / CH9 / CH10 / CH11 / CH12 / CH13 / CH14 / CH15 / CH16 / ?
AUDIO:LOUD:PEAKHOLD:DATA:L	? (Return value: PEAK L / -)
AUDIO:LOUD:PEAKHOLD:DATA:R	? (Return value: PEAK R / -)
AUDIO:LOUD:PEAKHOLD:DATA:C	? (Return value: PEAK C / -)
AUDIO:LOUD:PEAKHOLD:DATA:LFE	? (Return value: PEAK LFE / -)
AUDIO:LOUD:PEAKHOLD:DATA:LS	? (Return value: PEAK Ls / -)
AUDIO:LOUD:PEAKHOLD:DATA:RS	? (Return value: PEAK Rs / -)
AUDIO:LOUD:PEAKHOLD:DATA:SL	? (Return value: PEAK S-L / -)
AUDIO:LOUD:PEAKHOLD:DATA:SR	? (Return value: PEAK S-R / -)
AUDIO:DOLBY	OFF / E / D / ?
AUDIO:DOLBY:GROUP	CH_1_2 / CH_3_4 / CH_5_6 / CH_7_8 / CH_9_10 / CH11_12 / CH13_14 / CH15_16 / ?
AUDIO:DOLBY:E_DIALNORM	ON / OFF / ?
AUDIO:DOLBY:E_PULLDOWN	ON / OFF / ?

11. ETHERNET REMOTE CONTROL

Command	Parameter
AUDIO:DOLBY:E_META_PRM	PRM1 / PRM2 / PRM3 / PRM4 / PRM5 / PRM6 / PRM7 / PRM8 / ?
AUDIO:DOLBY:EBI_META_PRM	PRM1 / PRM2 / PRM3 / PRM4 / PRM5 / PRM6 / PRM7 / PRM8 / ?
AUDIO:DOLBY:D_LISTENING	FULL / EX / 3STEREO / PHANTOM / STEREO / MONO / ?
AUDIO:DOLBY:D_PROLOGIC	ON / OFF / ?
AUDIO:DOLBY:D_DRC	BYPASS / LINE / RF / ?
AUDIO:DOLBYMIX	OFF / ON / ?
AUDIO:PHONES:VOLUME	0 to 63 / ?
AUDIO:PHONES:L_CH	CH1 / CH2 / CH3 / CH4 / CH5 / CH6 / CH7 / CH8 / CH9 / CH10 / CH11 / CH12 / CH13 / CH14 / CH15 / CH16 / A1 / A2 / A3 / A4 / A5 / A6 / A7 / A8 / A9 / A10 / A11 / A12 / A13 / A14 / A15 / A16 / B1 / B2 / B3 / B4 / B5 / B6 / B7 / B8 / B9 / B10 / B11 / B12 / B13 / B14 / B15 / B16 / LT / DAUX / ?
AUDIO:PHONES:R_CH	CH1 / CH2 / CH3 / CH4 / CH5 / CH6 / CH7 / CH8 / CH9 / CH10 / CH11 / CH12 / CH13 / CH14 / CH15 / CH16 / A1 / A2 / A3 / A4 / A5 / A6 / A7 / A8 / A9 / A10 / A11 / A12 / A13 / A14 / A15 / A16 / B1 / B2 / B3 / B4 / B5 / B6 / B7 / B8 / B9 / B10 / B11 / B12 / B13 / B14 / B15 / B16 / RT / DAUX / ?
AUDIO:PHONES:DOLBY:DAUX:CH	LTRT / LORO / MONO / MUTE / ?
AUDIO:PHONES:DOLBY:DAUX:DRC	LINE / RF / ?

Table 11-6 File generation commands

Command	Parameter
MAKE	LOG / DUMP / CAPTURE / CAP_FRM / CAP_DPX / CAP_TIF / CAP_FRM_B / CAP_DPX_B / CAP_TIF_B / CAP_FRM_S2 / CAP_DPX_S2 / CAP_TIF_S2 / LOUDNESS * Retrieve generated files using FTP. * DUMP is valid only when the data dump display is showing. * CAPTURE is valid only for screen captures. * CAP_*** is valid only for frame captures. * CAP_***_B generates channel B of simul mode. * CAP_***_S2 generates stream 2 of 3G-B (2map). * LOUDNESS generates two files: csv and txt. If measurement is in progress, measurement stops.

## 11.2 FTP

The files that are generated by the LV 5770A can be transferred to a PC connected to the same network.

## 11.2.1 Procedure

**1. Configure the Ethernet settings on the LV 5770A's ETHERNET SETUP tab.**

Set the IP Address, and set FTP Server Select to ON.

Reference 7.2.2, "Configuring Ethernet Settings"

SYS → F•2 SYSTEM SETUP → F•3 NEXT TAB →

GENERAL SETUP	ETHERNET SETUP	REMOTE SETUP	DATE&TIME
Ethernet Select		<input type="checkbox"/> DHCP	<input checked="" type="checkbox"/> IP
TCP / IP			
IP Address		<input type="text" value="192"/>	<input type="text" value="168"/> <input type="text" value="0"/> <input type="text" value="1"/>
Subnet Mask		<input type="text" value="255"/>	<input type="text" value="255"/> <input type="text" value="255"/> <input type="text" value="0"/>
Default Gateway		<input type="text" value="0"/>	<input type="text" value="0"/> <input type="text" value="0"/> <input type="text" value="0"/>
SNTP Client Select		<input checked="" type="checkbox"/> OFF	<input type="checkbox"/> ON
Server IP Address		<input type="text" value="0"/>	<input type="text" value="0"/> <input type="text" value="0"/> <input type="text" value="0"/>
Time Zone Adjust		<input type="text" value="+"/>	<input type="text" value="9"/> : <input type="text" value="0"/> [ +/- hour : minutes ]
TELNET Server Select		<input checked="" type="checkbox"/> OFF	<input type="checkbox"/> ON <input type="checkbox"/> LV7770-01
FTP Server Select		<input type="checkbox"/> OFF	<input checked="" type="checkbox"/> ON
HTTP Server Select		<input checked="" type="checkbox"/> OFF	<input type="checkbox"/> ON
SNMP READ		<input checked="" type="checkbox"/> OFF	<input type="checkbox"/> ONLY <input type="checkbox"/> WRITE
SNMP TRAP		<input checked="" type="checkbox"/> OFF	<input type="checkbox"/> ON
NETWORK MODE		<input type="checkbox"/> LV5770	<input checked="" type="checkbox"/> LV5770A
MAC ADDRESS: 00:00:00:00:00:00			

Figure 11-2 ETHERNET SETUP tab

**2. Press F•1 COMPLETE.**

The message "Saving data - Please Wait" is displayed.

**3. If you changed the IP address, after the message disappears, restart the LV 5770A.**

The new IP address will take effect.

**4. Connect the LV 5770A's Ethernet port to the network.**

Use a UTP cable (category 5).

**5. On the PC, start an FTP client.**

On Windows 7, on the taskbar, click Start, and then click Run. Type "FTP" and the IP address that you set in step 1. Then, click OK.

**6. Type the user name and password.**

The user name and password are "LV5770A". Use uppercase for all characters. When the user name and password are entered correctly, "ftp>" appears.

```

Connected to ***.***.***.***.
220 FTP Server ready
User (***.***.***.***.(none)): LV5770A..... user name
331 Password required
Password: LV5770A ..... password (The password is not actually displayed.)
230 Logged in
ftp>

```

**7. Enter FTP commands.**

Enter commands while referring to sections 11.2.2, "How to Enter Commands," and 11.2.3, "FTP Commands." You must generate files using the TELNET "MAKE" command before you use FTP commands.

To end an FTP session, type "bye."

```
ftp> bye
```

**11.2.2 How to Enter Commands**

The command syntax is explained below.

```
ftp> [Command] + [Space] + [Parameter 1] + [Space] + [Parameter 2]
```

Examples of how to enter commands are shown below.

```

ftp> GET LOG.TXT D:¥LOG.TXT ..... Transfer the event log file to the PC.
200 PORT Command successful..... Return value
...
ftp>

```

## 11.2.3 FTP Commands

Table 11-7 FTP commands

Command	Parameter 1	Parameter 2
GET	LOG.TXT	Storage location on the PC and file name (example: D:¥LOG.TXT)
	DUMP.TXT	Storage location on the PC and file name (example: D:¥DUMP.TXT)
	CAPTURE.BMP	Storage location on the PC and file name (example: D:¥CAPTURE.BMP)
	CAP_***.FRM	Storage location on the PC and file name (example: D:¥CAP_FRM.FRM)
	CAP_***.DPX	Storage location on the PC and file name (example: D:¥CAP_DPX.DPX)
	CAP_***.TIF	Storage location on the PC and file name (example: D:¥CAP_TIF.TIF)
	LOUDNESS.CSV	Storage location on the PC and file name (example: D:¥LOUDNESS.CSV)
	LOUDNESS.TXT	Storage location on the PC and file name (example: D:¥LOUDNESS.TXT)

## 11.3 SNMP

By using SNMP (Simple Network Management Protocol), you can control an LV 5770A from SNMP managers. Additionally, you can notify the SNMP managers of errors that the LV 5770A generates.

The LV 5770A supports SNMPv1.

### 11.3.1 SMI Definitions

IMPORTS

MODULE-IDENTITY, OBJECT-TYPE, NOTIFICATION-TYPE, enterprises  
FROM SNMPv2-SMI

DisplayString

FROM SNMPv2-TC

OBJECT-GROUP, MODULE-COMPLIANCE

FROM SNMPv2-CONF;

### 11.3.2 Procedure

#### 1. Configure the Ethernet settings on the LV 5770A's ETHERNET SETUP tab.

Set the IP Address, and set SNMP READ to WRITE and SNMP TRAP to ON.

Reference 7.2.2, "Configuring Ethernet Settings"

SYS → F•2 SYSTEM SETUP → F•3 NEXT TAB →

GENERAL SETUP	ETHERNET SETUP	REMOTE SETUP	DATE&TIME
Ethernet Select		<input type="checkbox"/> DHCP	<input checked="" type="checkbox"/> IP
TCP / IP			
IP Address		192	168 0 1
Subnet Mask		255	255 255 0
Default Gateway		0	0 0 0
SNTP Client Select		<input checked="" type="checkbox"/> OFF	<input type="checkbox"/> ON
Server IP Address		0	0 0 0
Time Zone Adjust		+	9 : 0 [ +/- hour : minutes ]
TELNET Server Select		<input checked="" type="checkbox"/> OFF	<input type="checkbox"/> ON <input type="checkbox"/> LV7770-01
FTP Server Select		<input checked="" type="checkbox"/> OFF	<input type="checkbox"/> ON
HTTP Server Select		<input checked="" type="checkbox"/> OFF	<input type="checkbox"/> ON
SNMP READ		<input type="checkbox"/> OFF	<input type="checkbox"/> ONLY <input checked="" type="checkbox"/> WRITE
SNMP TRAP		<input type="checkbox"/> OFF	<input checked="" type="checkbox"/> ON
NETWORK MODE		<input type="checkbox"/> LV5770	<input checked="" type="checkbox"/> LV5770A
MAC ADDRESS: 00:00:00:00:00:00			

Figure 11-3 ETHERNET SETUP tab

#### 2. Press F•1 COMPLETE.

The message "Saving data - Please Wait" is displayed.

#### 3. If you changed the IP address, after the message disappears, restart the LV 5770A.

The new IP address will take effect.

#### 4. Connect the LV 5770A's Ethernet port to the network.

Use a UTP cable (category 5).

**5. On the PC, start an SNMP manager.**

You must provide the SNMP manager yourself.  
The community name is shown below.

Read community: LDRUser  
Write community: LDRAdm  
TRAP community: LDRUser

**6. Check that the SNMP managers can perform GET and SET operations.****7. From the SNMP manager, set the following MIB items to the SNMP managers' IP addresses.**

Up to four locations can be set.

[IP address of TRAP transmission destination 1]

1.3.6.1.4.1.leader(20111).lv5770a(33).lv5770aST1(1).I33trapTBL(9).I33trapIpTBL(2).I33trapIp1TBL(1).I33trapManagerIp1(1).0

[IP address of TRAP transmission destination 2]

1.3.6.1.4.1.leader(20111).lv5770a(33).lv5770aST1(1).I33trapTBL(9).I33trapIpTBL(2).I33trapIp2TBL(2).I33trapManagerIp2(1).0

[IP address of TRAP transmission destination 3]

1.3.6.1.4.1.leader(20111).lv5770a(33).lv5770aST1(1).I33trapTBL(9).I33trapIpTBL(2).I33trapIp3TBL(3).I33trapManagerIp3(1).0

[IP address of TRAP transmission destination 4]

1.3.6.1.4.1.leader(20111).lv5770a(33).lv5770aST1(1).I33trapTBL(9).I33trapIpTBL(2).I33trapIp4TBL(4).I33trapManagerIp4(1).0

**8. Enable the TRAP transmission destinations.**

To alleviate communication load, disable the transmission destinations that you are not using. The factory default setting is disabled.

[Enable (1) or disable (2) TRAP transmission destination 1]

1.3.6.1.4.1.leader(20111).lv5770a(33).lv5770aST1(1).I33trapTBL(9).I33trapIpTBL(2).I33trapIp1TBL(1).I33trapManagerIp1Act(2).0

[Enable (1) or disable (2) TRAP transmission destination 2]

1.3.6.1.4.1.leader(20111).lv5770a(33).lv5770aST1(1).I33trapTBL(9).I33trapIpTBL(2).I33trapIp2TBL(2).I33trapManagerIp2Act(2).0

[Enable (1) or disable (2) TRAP transmission destination 3]

1.3.6.1.4.1.leader(20111).lv5770a(33).lv5770aST1(1).I33trapTBL(9).I33trapIpTBL(2).I33trapIp3TBL(3).I33trapManagerIp3Act(2).0

[Enable (1) or disable (2) TRAP transmission destination 4]

1.3.6.1.4.1.leader(20111).lv5770a(33).lv5770aST1(1).I33trapTBL(9).I33trapIpTBL(2).I33trapIp4TBL(4).I33trapManagerIp4Act(2).0

**9. Restart the LV 5770A.****10. When the LV 7800 starts, it transmits the standard TRAP "coldStart(0)." Check that this is received by the SNMP managers.**



## 11.3.3 Standard MIB

The LV 5770A uses the following standard MIBs:

- RFC1213 (MIB-II)
- RFC1354 (IP Forwarding Table MIB)

In the tables, "ACCESS" and "SUPPORT" indicate the following:

	Indication	Description
ACCESS	R/O	Information that can be read from the SNMP managers.
	R/W	Information that can be read and written from the SNMP managers.
SUPPORT	○	Supports the MIB object as defined by the standard.
	△	Reading and writing are possible according to the standard, but the LV 5770A only supports reading.
	×	Not supported.

Table 11-8 system group

MIB	OID	SYNTAX	ACCESS	SUPPORT
sysDescr	system.1	DisplayString	R/O	○
sysObjectID	system.2	ObjectID	R/O	○
sysUpTime	system.3	TimeTicks	R/O	○
sysContact (*1)	system.4	DisplayString	R/W	○
sysName (*1)	system.5	DisplayString	R/W	○
sysLocation (*1)	system.6	DisplayString	R/W	○
sysServices	system.7	INTEGER	R/O	○

\*1 Set using up to 40 bytes.

Table 11-9 interface group

MIB	OID	SYNTAX	ACCESS	SUPPORT
ifNumber	interfaces.1	INTEGER	R/O	○
ifTable	interfaces.2	Aggregate	-	○
ifEntry	ifTable.1	Aggregate	-	○
ifIndex	ifEntry.1	INTEGER	R/O	○
ifDescr	ifEntry.2	DisplayString	R/O	○
ifType	ifEntry.3	INTEGER	R/O	○
ifMtu	ifEntry.4	INTEGER	R/O	○
ifSpeed	ifEntry.5	Gauge	R/O	○
ifPhysAddress	ifEntry.6	DisplayString	R/O	○
ifAdminStatus	ifEntry.7	INTEGER	R/O	△
ifOperStatus	ifEntry.8	INTEGER	R/O	△
ifLastChange	ifEntry.9	TimeTicks	R/O	○
ifInOctets	ifEntry.10	Counter	R/O	○
ifInUcastPkts	ifEntry.11	Counter	R/O	○
ifInNUcastPkts	ifEntry.12	Counter	R/O	○
ifInDiscards	ifEntry.13	Counter	R/O	○
ifInErrors	ifEntry.14	Counter	R/O	○

## 11. ETHERNET REMOTE CONTROL

MIB	OID	SYNTAX	ACCESS	SUPPORT
ifInUnknownProtos	ifEntry.15	Counter	R/O	○
ifOutOctets	ifEntry.16	Counter	R/O	○
ifOutUcastPkts	ifEntry.17	Counter	R/O	○
ifOutNUcastPkts	ifEntry.18	Counter	R/O	○
ifOutDiscards	ifEntry.19	Counter	R/O	○
ifOutErrors	ifEntry.20	Counter	R/O	○
ifOutQLen	ifEntry.21	Gauge	R/O	○
ifSpecific	ifEntry.22	ObjectID	R/O	○

Table 11-10 ip group

MIB	OID	SYNTAX	ACCESS	SUPPORT
ipForwarding	ip.1	INTEGER	R/O	○
ipDefaultTTL	ip.2	INTEGER	R/O	○
ipInReceives	ip.3	Counter	R/O	○
ipInHdrErrors	ip.4	Counter	R/O	○
ipInAddrErrors	ip.5	Counter	R/O	○
ipForwDatagrams	ip.6	Counter	R/O	○
ipInUnknownProtos	ip.7	Counter	R/O	○
ipInDiscards	ip.8	Counter	R/O	○
ipInDelivers	ip.9	Counter	R/O	○
ipOutRequests	ip.10	Counter	R/O	○
ipOutDiscards	ip.11	Counter	R/O	○
ipOutNoRoutes	ip.12	Counter	R/O	○
ipReasmTimeout	ip.13	INTEGER	R/O	○
ipReasmReqds	ip.14	Counter	R/O	○
ipReasmOKs	ip.15	Counter	R/O	○
ipReasmFails	ip.16	Counter	R/O	○
ipFragOKs	ip.17	Counter	R/O	○
ipFragFails	ip.18	Counter	R/O	○
ipFragCreates	ip.19	Counter	R/O	○
ipAddrTable	ip.20	Aggregate	-	○
ipAddrEntry	ipAddrTable.1	Aggregate	-	○
ipAdEntAddr	ipAddrEntry.1	IpAddress	R/O	○
ipAdEntIfIndex	ipAddrEntry.2	INTEGER	R/O	○
ipAdEntNetMask	ipAddrEntry.3	IpAddress	R/O	○
ipAdEntBcastAddr	ipAddrEntry.4	INTEGER	R/O	○
ipAdEntReasmMaxSize	ipAddrEntry.5	INTEGER	R/O	○
ipNetToMediaTable	ip.22	Aggregate	-	○
ipNetToMediaEntry	ipNetToMediaTable.1	Aggregate	-	○
ipNetToMediaIfIndex	ipNetToMediaEntry.1	INTEGER	R/O	△
ipNetToMediaPhysAddress	ipNetToMediaEntry.2	DisplayString	R/O	△
ipNetToMediaNetAddress	ipNetToMediaEntry.3	IpAddress	R/O	△
ipNetToMediaType	ipNetToMediaEntry.4	INTEGER	R/O	△
ipRoutingDiscards	ip.23	Counter	R/O	○
ipForward	ip.24	Aggregate	-	○

## 11. ETHERNET REMOTE CONTROL

MIB	OID	SYNTAX	ACCESS	SUPPORT
ipForwardNumber	ipForward .1	Gauge	R/O	○
ipForwardTable	ipForward .2	Aggregate	-	○
ipForwardDest	ipForwardTable.1	IpAddress	R/O	○
ipForwardMask	ipForwardTable.1	IpAddress	R/O	○
ipForwardPolicy	ipForwardTable.1	INTEGER	R/O	×
ipForwardNextHop	ipForwardTable.1	IpAddress	R/O	○
ipForwardIfIndex	ipForwardTable.1	INTEGER	R/O	○
ipForwardType	ipForwardTable.1	INTEGER	R/O	×
ipForwardProto	ipForwardTable.1	INTEGER	R/O	×
ipForwardAge	ipForwardTable.1	INTEGER	R/O	×
ipForwardInfo	ipForwardTable.1	ObjectID	R/O	×
ipForwardNextHopAS	ipForwardTable.1	INTEGER	R/O	×
ipForwardMetric1	ipForwardTable.1	INTEGER	R/O	×
ipForwardMetric2	ipForwardTable.1	INTEGER	R/O	×
ipForwardMetric3	ipForwardTable.1	INTEGER	R/O	×
ipForwardMetric4	ipForwardTable.1	INTEGER	R/O	×
ipForwardMetric5	ipForwardTable.1	INTEGER	R/O	×

Table 11-11 icmp group

MIB	OID	SYNTAX	ACCESS	SUPPORT
icmpInMsgs	icmp.1	Counter	R/O	○
icmpInErrors	icmp.2	Counter	R/O	○
icmpInDestUnreachs	icmp.3	Counter	R/O	○
icmpInTimeExcds	icmp.4	Counter	R/O	○
icmpInParmProbs	icmp.5	Counter	R/O	○
icmpInSrcQuenchs	icmp.6	Counter	R/O	○
icmpInRedirects	icmp.7	Counter	R/O	○
icmpInEchos	icmp.8	Counter	R/O	○
icmpInEchoReps	icmp.9	Counter	R/O	○
icmpInTimestamps	icmp.10	Counter	R/O	○
icmpInTimestampReps	icmp.11	Counter	R/O	○
icmpInAddrMasks	icmp.12	Counter	R/O	○
icmpInAddrMaskReps	icmp.13	Counter	R/O	○
icmpOutMsgs	icmp.14	Counter	R/O	○
icmpOutErrors	icmp.15	Counter	R/O	○
icmpOutDestUnreachs	icmp.16	Counter	R/O	○
icmpOutTimeExcds	icmp.17	Counter	R/O	○
icmpOutParmProbs	icmp.18	Counter	R/O	○
icmpOutSrcQuenchs	icmp.19	Counter	R/O	○
icmpOutRedirects	icmp.20	Counter	R/O	○
icmpOutEchos	icmp.21	Counter	R/O	○
icmpOutEchoReps	icmp.22	Counter	R/O	○
icmpOutTimestamps	icmp.23	Counter	R/O	○
icmpOutTimestampReps	icmp.24	Counter	R/O	○
icmpOutAddrMasks	icmp.25	Counter	R/O	○

## 11. ETHERNET REMOTE CONTROL

MIB	OID	SYNTAX	ACCESS	SUPPORT
icmpOutAddrMaskReps	icmp.26	Counter	R/O	○

Table 11-12 tcp group

MIB	OID	SYNTAX	ACCESS	SUPPORT
tcpRtoAlgorithm	tcp.1	INTEGER	R/O	○
tcpRtoMin	tcp.2	INTEGER	R/O	○
tcpRtoMax	tcp.3	INTEGER	R/O	○
tcpMaxConn	tcp.4	INTEGER	R/O	○
tcpActiveOpens	tcp.5	Counter	R/O	○
tcpPassiveOpens	tcp.6	Counter	R/O	○
tcpAttemptFails	tcp.7	Counter	R/O	○
tcpEstabResets	tcp.8	Counter	R/O	○
tcpCurrEstab	tcp.9	Gauge	R/O	○
tcpInSegs	tcp.10	Counter	R/O	○
tcpOutSegs	tcp.11	Counter	R/O	○
tcpRetransSegs	tcp.12	Counter	R/O	○
tcpConnTable	tcp.13	Aggregate	-	○
tcpConnEntry	tcpConnTable.1	Aggregate	-	○
tcpConnState	tcpConnEntry.1	INTEGER	R/O	△
tcpConnLocalAddress	tcpConnEntry.2	IpAddress	R/O	○
tcpConnLocalPort	tcpConnEntry.3	INTEGER	R/O	○
tcpConnRemAddress	tcpConnEntry.4	IpAddress	R/O	○
tcpConnRemPort	tcpConnEntry.5	INTEGER	R/O	○
tcpInErrs	tcp.14	Counter	R/O	○
tcpOutRsts	tcp.15	Counter	R/O	○

Table 11-13 udp group

MIB	OID	SYNTAX	ACCESS	SUPPORT
udpInDatagrams	udp.1	Counter	R/O	○
udpNoPorts	udp.2	Counter	R/O	○
udpInErrors	udp.3	Counter	R/O	○
udpOutDatagrams	udp.4	Counter	R/O	○
udpTable	udp.5	Aggregate	-	○
udpEntry	udpTable.1	Aggregate	-	○
udpLocalAddress	udpEntry.1	IpAddress	R/O	○
udpLocalPort	udpEntry.2	INTEGER	R/O	○

Table 11-14 snmp group

MIB	OID	SYNTAX	ACCESS	SUPPORT
snmpInPkts	snmp.1	Counter	R/O	○
snmpOutPkts	snmp.2	Counter	R/O	○
snmpInBadVersions	snmp.3	Counter	R/O	○
snmpInBadCommunityNames	snmp.4	Counter	R/O	○
snmpInBadCommunityUses	snmp.5	Counter	R/O	○

## 11. ETHERNET REMOTE CONTROL

MIB	OID	SYNTAX	ACCESS	SUPPORT
snmpInASNParseErrs	snmp.6	Counter	R/O	o
snmpInTooBig	snmp.8	Counter	R/O	o
snmpInNoSuchNames	snmp.9	Counter	R/O	o
snmpInBadValues	snmp.10	Counter	R/O	o
snmpInReadOnly	snmp.11	Counter	R/O	o
snmpInGenErrs	snmp.12	Counter	R/O	o
snmpInTotalReqVars	snmp.13	Counter	R/O	o
snmpInTotalSetVars	snmp.14	Counter	R/O	o
snmpInGetRequests	snmp.15	Counter	R/O	o
snmpInGetNexts	snmp.16	Counter	R/O	o
snmpInSetRequests	snmp.17	Counter	R/O	o
snmpInGetResponses	snmp.18	Counter	R/O	o
snmpInTraps	snmp.19	Counter	R/O	o
snmpOutTooBig	snmp.20	Counter	R/O	o
snmpOutNoSuchNames	snmp.21	Counter	R/O	o
snmpOutBadValues	snmp.22	Counter	R/O	o
snmpOutGenErrs	snmp.24	Counter	R/O	o
snmpOutGetRequests	snmp.25	Counter	R/O	o
snmpOutGetNexts	snmp.26	Counter	R/O	o
snmpOutSetRequests	snmp.27	Counter	R/O	o
snmpOutGetResponses	snmp.28	Counter	R/O	o
snmpOutTraps	snmp.29	Counter	R/O	o
snmpEnableAuthenTraps	snmp.30	IpAddress	R/W	o

11.3.4 Enterprise MIB

- **Enterprise Number**

The Enterprise Number of LEADER ELECTRONICS CORP. is 20111.  
iso(1).org(3).dod(6).internet(1).private(4).enterprises(1).leader(20111)

- **Enterprise MIB File**

Download the enterprise MIB file using FTP.  
The file name is "lv5770a.my." (Example: GET LV5770A.MY D:¥LV5770A.MY)

- **Enterprise MIB Structure**

The enterprise MIB structure is shown below. On products that do not have units installed, the MIBs for the units cannot be controlled.

```

leader      OBJECT IDENTIFIER ::= { enterprises 20111 }
lv5770a     OBJECT IDENTIFIER ::= { leader 33 }
lv5770aST1 OBJECT IDENTIFIER ::= { lv5770a 1 }
basic       OBJECT IDENTIFIER ::= { lv5770aST1 1 } <-- Basic operation
system      OBJECT IDENTIFIER ::= { lv5770aST1 2 } <-- SYSTEM menu
wfm         OBJECT IDENTIFIER ::= { lv5770aST1 3 } <-- WFM menu
vector      OBJECT IDENTIFIER ::= { lv5770aST1 4 } <-- VECTOR menu
picture     OBJECT IDENTIFIER ::= { lv5770aST1 5 } <-- PICTURE menu
status      OBJECT IDENTIFIER ::= { lv5770aST1 6 } <-- STATUS menu
eye         OBJECT IDENTIFIER ::= { lv5770aST1 7 } <-- EYE menu
audio       OBJECT IDENTIFIER ::= { lv5770aST1 8 } <-- AUDIO menu
trap        OBJECT IDENTIFIER ::= { lv5770aST1 9 } <-- Trap information
    
```

- **ACCESS**

In the tables, "ACCESS" indicates the following:

	Indication	Description
ACCESS	R/O	Information that can be read from the SNMP managers.
	R/W	Information that can be read and written from the SNMP managers.
	R/WO	Information that can be read and written from the SNMP managers. (However, the retrieved data consists of meaningless fixed values.)

11. ETHERNET REMOTE CONTROL

Table 11-15 I33basicTBL(1) group

MIB	OID	SYNTAX	ACCESS	VALUE/RANGE
I33basInputTBL	I33basicTBL.1	Aggregate	-	-
I33basInputUnit	I33basInputTBL.1	INTEGER	R/W	1 = Sdi 2 = Analog Composite
I33basInputCh	I33basInputTBL.2	INTEGER	R/W	1 = A 2 = B 3 = AB
I33basInputSimul	I33basInputTBL.3	INTEGER	R/W	1 = Off 2 = On
I33basInputStream	I33basInputTBL.4	INTEGER	R/W	1 = Stream1 2 = Stream2
I33basExt	I33basicTBL.2	INTEGER	R/W	1 = Ext 2 = Int
I33basDisplay	I33basicTBL.3	INTEGER	R/W	1 = Display1 2 = Display2 3 = Display3 4 = Display4
I33basMulti	I33basicTBL.4	INTEGER	R/W	1 = Off 2 = On
I33basMode	I33basicTBL.5	INTEGER	R/W	1 = WFM 2 = Vector 3 = Picture 4 = Audio 5 = Status 6 = Eye
I33basRecall	I33basicTBL.6	INTEGER	R/WO	1 to 60
I33basFileTBL	I33basicTBL.7	Aggregate	-	-
I33basFileMakeLog	I33basFileTBL.1	INTEGER	R/WO	1 = Meke Log
I33basFileMakeDump	I33basFileTBL.2	INTEGER	R/WO	1 = Make Dump
I33basFileMakeCapture	I33basFileTBL.3	INTEGER	R/WO	1 = Make Capture
I33basFileMakeCapFrm	I33basFileTBL.4	INTEGER	R/WO	1 = Make Cap Frm
I33basFileMakeCapDpx	I33basFileTBL.5	INTEGER	R/WO	1 = Make Cap DPX
I33basFileMakeCapTif	I33basFileTBL.6	INTEGER	R/WO	1 = Make Cap TIF
I33basFileMakeCapFrmB	I33basFileTBL.7	INTEGER	R/WO	1 = Make Cap Frm SIMUL-B
I33basFileMakeCapDpxB	I33basFileTBL.8	INTEGER	R/WO	1 = Make Cap DPX SIMUL-B
I33basFileMakeCapTifB	I33basFileTBL.9	INTEGER	R/WO	1 = Make Cap TIF SIMUL-B
I33basFileMakeCapDpxS2	I33basFileTBL.10	INTEGER	R/WO	1 = Make Cap DPX STREAM-2
I33basFileMakeCapTifS2	I33basFileTBL.11	INTEGER	R/WO	1 = Make Cap TIF STREAM-2
I33basFileMakeLoudness	I33basFileTBL.12	INTEGER	R/WO	1 = Make Loudness Log
I33basCaptureTBL	I33basicTBL.8	Aggregate	-	-
I33basCaptureTrigger	I33basCaptureTBL.1	INTEGER	R/W	1 = Manual 2 = Error

Table 11-16 I33systemTBL(2) group

MIB	OID	SYNTAX	ACCESS	VALUE/RANGE
-----	-----	--------	--------	-------------

11. ETHERNET REMOTE CONTROL

MIB	OID	SYNTAX	ACCESS	VALUE/RANGE
I33sysFormatTBL	I33systemTBL.1	Aggregate	-	-
I33sysFormatManualSelect	I33sysFormatTBL.1	INTEGER	R/W	1 = Auto 2 = Manual
I33sysFormatIPSF	I33sysFormatTBL.2	INTEGER	R/W	1 = Interlace 2 = Segmented Frame
I33sysFormatLinkFormat	I33sysFormatTBL.3	INTEGER	R/W	1 = HD 2 = SD 3 = HD-Dual 4 = 3G-A 5 = 3G-B 6 = 3G-B 2Mapping
I33sysFormatColorSystem	I33sysFormatTBL.4	INTEGER	R/W	1 = YCbCr-422 2 = YCbCr-444 3 = RGB-444
I33sysFormatPixelFormatDepth	I33sysFormatTBL.5	INTEGER	R/W	1 = 10Bit 2 = 12Bit
I33sysFormatScanning	I33sysFormatTBL.6	INTEGER	R/W	1 = 1080p 2 = 1080i 3 = 1080psf 4 = 720p 5 = 525i 6 = 625i
I33sysFormatActiveSample	I33sysFormatTBL.7	INTEGER	R/W	1 = 1920 2 = 2048
I33sysFormatFrameRate	I33sysFormatTBL.8	INTEGER	R/W	1 = 60Hz 2 = 59.94Hz 3 = 50Hz 4 = 30Hz 5 = 29.97Hz 6 = 25Hz 7 = 24Hz 8 = 23.98Hz
I33sysFormatInputA	I33sysFormatTBL.9	INTEGER	R/O	Input A Format
I33sysFormatInputB	I33sysFormatTBL.10	INTEGER	R/O	Input B Format
I33sysRearTBL	I33systemTBL.2	Aggregate	-	-
I33sysRearSdiOutput	I33sysRearTBL.1	INTEGER	R/W	1 = AB 2 = A
I33sysRearAudioBncGrpA	I33sysRearTBL.2	INTEGER	R/W	1 = Input 2 = Output
I33sysRearAudioBncGrpB	I33sysRearTBL.3	INTEGER	R/W	1 = Input 2 = Output
I33sysRearAudioBncGrpAOutSel	I33sysRearTBL.4	INTEGER	R/W	1 = Display Source 2 = SDI 1-8
I33sysRearAudioBncGrpBOutSel	I33sysRearTBL.5	INTEGER	R/W	1 = Display Source 2 = SDI 9-16
I33sysRearAnalogAudio	I33sysRearTBL.6	INTEGER	R/W	1 = Input



11. ETHERNET REMOTE CONTROL

MIB	OID	SYNTAX	ACCESS	VALUE/RANGE
				2 = Output
I33sysRearDvi_IAspect	I33sysRearTBL.7	INTEGER	R/W	1 = 4:3 2 = 16:9 3 = 16:10
I33sysRearPicMoniOutColor	I33sysRearTBL.8	INTEGER	R/W	1 = Auto 2 = YCbCr-422 3 = YCbCr-444 4 = RGB-444
I33sysRearPicMoniOutPixelDepth	I33sysRearTBL.9	INTEGER	R/W	1 = Auto 2 = 8Bit 3 = 10Bit 4 = 12Bit
I33sysRearPicMoniOut2Mapping	I33sysRearTBL.10	INTEGER	R/W	1 = Stream1 2 = Stream2
I33sysGeneralTBL	I33systemTBL.3	Aggregate	-	-
I33sysGeneralMultiDisplay	I33sysGeneralTBL.1	INTEGER	R/W	1 = 2Multi 2 = 4Multi
I33sysGeneralCaptureMode	I33sysGeneralTBL.2	INTEGER	R/W	1 = Screen 2 = Video-Frame
I33sysGeneralInfoFormat	I33sysGeneralTBL.3	INTEGER	R/W	1 = On 2 = Off
I33sysGeneralInfoDate	I33sysGeneralTBL.4	INTEGER	R/W	1 = Off 2 = YMD 3 = MDY 4 = DMY
I33sysGeneralInfoTime	I33sysGeneralTBL.5	INTEGER	R/W	1 = Off 2 = Real 3 = LTC 4 = VITC 5 = D-VITC
I33sysGeneralInfoColorSystem	I33sysGeneralTBL.6	INTEGER	R/W	1 = On 2 = Off
I33sysGeneralInfoInput	I33sysGeneralTBL.7	INTEGER	R/W	1 = On 2 = Off
I33sysGeneralLcdAutoOff	I33sysGeneralTBL.9	INTEGER	R/W	1 = Off 2 = 5Min. 3 = 30Min. 4 = 60Min.
I33sysGeneralMenuAutoOff	I33sysGeneralTBL.10	DisplayString	R/W	1 to 60
I33sysGeneralMenuAutoOffCtr	I33sysGeneralTBL.11	INTEGER	R/W	1 = Off 2 = On
I33sysGeneralMemStrMode	I33sysGeneralTBL.13	INTEGER	R/W	1 = Loudness 2Hour 2 = Loudness 32Hour
I33sysGeneralBacklight	I33sysGeneralTBL.14	INTEGER	R/W	1 to 16
I33sysEthernetTBL	I33systemTBL.4	Aggregate	-	-
I33sysEthernetSelect	I33sysEthernetTBL.1	INTEGER	R/O	1 = DHCP

## 11. ETHERNET REMOTE CONTROL

MIB	OID	SYNTAX	ACCESS	VALUE/RANGE
				2 = IP
I33sysEthernetAddress	I33sysEthernetTBL.2	DisplayString	R/O	IP Address
I33sysEthernetSubnet	I33sysEthernetTBL.3	DisplayString	R/O	Subnet Mask
I33sysEthernetGateway	I33sysEthernetTBL.4	DisplayString	R/O	Default Gateway
I33sysEthernetSntpSelect	I33sysEthernetTBL.5	INTEGER	R/W	1 = Off 2 = On
I33sysEthernetSntpAdr1	I33sysEthernetTBL.6	INTEGER	R/W	0 to 255 (1st Seg.)
I33sysEthernetSntpAdr2	I33sysEthernetTBL.7	INTEGER	R/W	0 to 255 (2nd Seg.)
I33sysEthernetSntpAdr3	I33sysEthernetTBL.8	INTEGER	R/W	0 to 255 (3rd Srg.)
I33sysEthernetSntpAdr4	I33sysEthernetTBL.9	INTEGER	R/W	0 to 255 (4th Seg.)
I33sysEthernetSntpAddress	I33sysEthernetTBL.10	DisplayString	R/O	SNTP Server Address
I33sysEthernetSntpTzPole	I33sysEthernetTBL.11	INTEGER	R/W	1 = - 2 = +
I33sysEthernetSntpTzHour	I33sysEthernetTBL.12	INTEGER	R/W	0 to 23
I33sysEthernetSntpTzMinute	I33sysEthernetTBL.13	INTEGER	R/W	0 to 59
I33sysEthernetSntpTimezone	I33sysEthernetTBL.14	DisplayString	R/O	SNTP TimeZone Adjust
I33sysEthernetSntpSet	I33sysEthernetTBL.15	INTEGER	R/WO	1 = SNTP Reset
I33sysEthernetTelnetSelect	I33sysEthernetTBL.16	INTEGER	R/W	1 = Off 2 = On 3 = LV7770-01
I33sysEthernetFtpSelect	I33sysEthernetTBL.17	INTEGER	R/W	1 = Off 2 = On
I33sysEthernetHttpSelect	I33sysEthernetTBL.18	INTEGER	R/W	1 = Off 2 = On
I33sysEthernetMac	I33sysEthernetTBL.19	DisplayString	R/O	MAC Address
I33sysRemoteTBL	I33systemTBL.5	Aggregate	-	-
I33sysRemoteMode	I33sysRemoteTBL.1	INTEGER	R/W	1 = Bit 2 = Binary
I33sysRemoteSelect	I33sysRemoteTBL.2	INTEGER	R/W	1 = Recall 2 = Recall/Loudness
I33sysRemoteAlarmPolarity	I33sysRemoteTBL.3	INTEGER	R/W	1 = Positive 2 = Negative
I33sysRemoteAlarmSelect	I33sysRemoteTBL.4	INTEGER	R/W	1 = A 2 = B 3 = AB
I33sysOtherTBL	I33systemTBL.6	Aggregate	-	-
I33sysOtherDateYear	I33sysOtherTBL.1	INTEGER	R/W	1970 to 2099
I33sysOtherDateMonth	I33sysOtherTBL.2	INTEGER	R/W	1 to 12
I33sysOtherDateDate	I33sysOtherTBL.3	INTEGER	R/W	1 to 31
I33sysOtherDateHour	I33sysOtherTBL.4	INTEGER	R/W	0 to 23
I33sysOtherDateMinute	I33sysOtherTBL.5	INTEGER	R/W	0 to 59
I33sysOtherDateSecond	I33sysOtherTBL.6	INTEGER	R/W	0 to 59
I33sysOtherDateTimeSet	I33sysOtherTBL.7	INTEGER	R/WO	1 = Date & Time Set
I33sysOtherDateTime	I33sysOtherTBL.8	DisplayString	R/O	Date & Time
I33sysOtherInfoFirmware	I33sysOtherTBL.9	DisplayString	R/O	Firmware Version

11. ETHERNET REMOTE CONTROL

MIB	OID	SYNTAX	ACCESS	VALUE/RANGE
I33sysOtherInfoBoardSdi	I33sysOtherTBL.10	INTEGER	R/O	1 = Not installed 2 = Installed
I33sysOtherInfoBoardEye	I33sysOtherTBL.11	INTEGER	R/O	1 = Not installed 2 = Installed
I33sysOtherInfoBoardCmp	I33sysOtherTBL.12	INTEGER	R/O	1 = Not installed 2 = Installed
I33sysOtherInfoBoardAudDig41	I33sysOtherTBL.13	INTEGER	R/O	1 = Not installed 2 = Installed
I33sysOtherInfoBoardAudAna	I33sysOtherTBL.14	INTEGER	R/O	1 = Not installed 2 = Installed
I33sysOtherInfoBoardAudDig43	I33sysOtherTBL.15	INTEGER	R/O	1 = Not installed 2 = Installed
I33sysOtherShortcut	I33sysOtherTBL.16	INTEGER	R/W	1 = Direct 2 = Volume 3 = Capture & Write 4 = Inten 5 = Menu Off
I33sysOtherLcdoff	I33sysOtherTBL.17	INTEGER	R/WO	1 = LCD Off
I33sysOtherLcdon	I33sysOtherTBL.18	INTEGER	R/WO	1 = LCD On
I33sysOtherInit	I33sysOtherTBL.19	INTEGER	R/WO	1 = Initialize
I33sysOtherKeylock	I33sysOtherTBL.20	INTEGER	R/W	1 = Off 2 = On
I33sysOtherRemoteReply	I33sysOtherTBL.21	INTEGER	R/W	1 = Off 2 = On

Table 11-17 I33wfmTBL(3) group

MIB	OID	SYNTAX	ACCESS	VALUE/RANGE
I33wfmDispTBL	I33wfmTBL.1	Aggregate	-	-
I33wfmDispCh1	I33wfmDispTBL.1	INTEGER	R/W	1 = On 2 = Off
I33wfmDispCh2	I33wfmDispTBL.2	INTEGER	R/W	1 = On 2 = Off
I33wfmDispCh3	I33wfmDispTBL.3	INTEGER	R/W	1 = On 2 = Off
I33wfmDispOvlay	I33wfmDispTBL.4	INTEGER	R/W	1 = On 2 = Off
I33wfmIntenTBL	I33wfmTBL.2	Aggregate	-	-
I33wfmIntenWfm	I33wfmIntenTBL.1	INTEGER	R/W	-128 to 127
I33wfmColor	I33wfmIntenTBL.2	INTEGER	R/W	1 = White 2 = Yellow 3 = Cyan 4 = Green 5 = Magenta 6 = Red 7 = Blue

11. ETHERNET REMOTE CONTROL

MIB	OID	SYNTAX	ACCESS	VALUE/RANGE
				8 = Multi
I33wfmColor2MapS1	I33wfmIntenTBL.3	INTEGER	R/W	1 = White 2 = Yellow 3 = Cyan 4 = Green 5 = Magenta 6 = Red 7 = Blue 8 = Multi
I33wfmColor2MapS2	I33wfmIntenTBL.4	INTEGER	R/W	1 = White 2 = Yellow 3 = Cyan 4 = Green 5 = Magenta 6 = Red 7 = Blue 8 = Multi
I33wfmIntenScale	I33wfmIntenTBL.5	INTEGER	R/W	-8 to 7
I33wfmScaleTBL	I33wfmTBL.3	Aggregate	-	-
I33wfmScaleColor	I33wfmScaleTBL.1	INTEGER	R/W	1 = White 2 = Yellow 3 = Cyan 4 = Green 5 = Magenta 6 = Red 7 = Blue
I33wfmScaleUnit	I33wfmScaleTBL.2	INTEGER	R/W	1 = HDV-SDP 2 = HDV-SDV 3 = HDP-SDP 4 = 150% 5 = 1023 6 = 3FF 7 = 1023_255
I33wfmScaleColor75per	I33wfmScaleTBL.3	INTEGER	R/W	1 = On 2 = Off
I33wfmGainTBL	I33wfmTBL.4	Aggregate	-	-
I33wfmGainVar	I33wfmGainTBL.1	INTEGER	R/W	1 = Cal 2 = Var
I33wfmGainVal	I33wfmGainTBL.2	DisplayString	R/W	0.200 to 2.000
I33wfmGainMag	I33wfmGainTBL.3	INTEGER	R/W	1 = X1 2 = X5
I33wfmFilterTBL	I33wfmTBL.5	Aggregate	-	-
I33wfmFilterNormal	I33wfmFilterTBL.1	INTEGER	R/W	1 = Flat 2 = Lowpass
I33wfmFilterComposite	I33wfmFilterTBL.2	INTEGER	R/W	1 = Flat 2 = Lum

11. ETHERNET REMOTE CONTROL

MIB	OID	SYNTAX	ACCESS	VALUE/RANGE
				2 = Flat-Lum 3 = Lum-Chroma
I33wfmSweepTBL	I33wfmTBL.6	Aggregate	-	-
I33wfmSweepSweep	I33wfmSweepTBL.1	INTEGER	R/W	1 = H 2 = V
I33wfmSweepHSweep	I33wfmSweepTBL.2	INTEGER	R/W	1 = 1H 2 = 2H
I33wfmSweepVSweep	I33wfmSweepTBL.3	INTEGER	R/W	1 = 1V 2 = 2V
I33wfmSweepHMag	I33wfmSweepTBL.4	INTEGER	R/W	1 = X1 2 = X10 3 = X20 4 = Active 5 = Blank
I33wfmSweepVMag	I33wfmSweepTBL.5	INTEGER	R/W	1 = X1 2 = X20 3 = X40
I33wfmSweepField	I33wfmSweepTBL.6	INTEGER	R/W	1 = Field1 2 = Field2
I33wfmBlankingTBL	I33wfmTBL.7	Aggregate	-	-
I33wfmBlankingNormal	I33wfmBlankingTBL.1	INTEGER	R/W	1 = Remove 2 = H-View 3 = V-View 4 = ALL-View
I33wfmBlankingComposite	I33wfmBlankingTBL.2	INTEGER	R/W	1 = Remove 2 = V-View
I33wfmLineSelTBL	I33wfmTBL.8	Aggregate	-	-
I33wfmLineSelect	I33wfmLineSelTBL.1	INTEGER	R/W	1 = On 2 = A-Ch 3 = B-Ch 4 = Both 5 = 3G-B 2Map Stream1 6 = 3G-B 2Map Stream2 7 = Off 8 = CINELITE
I33wfmLineField	I33wfmLineSelTBL.2	INTEGER	R/W	1 = Field1 2 = Field2 3 = Frame
I33wfmLineNumber	I33wfmLineSelTBL.3	INTEGER	R/W	1 to 1125
I33wfmDisplayTBL	I33wfmTBL.9	Aggregate	-	-
I33wfmDisplaySimul	I33wfmDisplayTBL.1	INTEGER	R/W	1 = Mix 2 = Align
I33wfmDisplay2Map	I33wfmDisplayTBL.2	INTEGER	R/W	1 = Stream1 2 = Stream2 3 = Mix 4 = Align

11. ETHERNET REMOTE CONTROL

MIB	OID	SYNTAX	ACCESS	VALUE/RANGE
I33wfmDisplayThumbnailAudio	I33wfmDisplayTBL.3	INTEGER	R/W	1 = Off 2 = On
I33wfmDisplayThumbnailPicture	I33wfmDisplayTBL.4	INTEGER	R/W	1 = Off 2 = On
I33wfmDisplayThumbHisto	I33wfmDisplayTBL.5	INTEGER	R/W	1 = Off 2 = On
I33wfmDisplayThumbHistoForm	I33wfmDisplayTBL.6	INTEGER	R/W	1 = Luma 2 = Align 3 = Mix
I33wfmDisplayThumbHistoMixY	I33wfmDisplayTBL.7	INTEGER	R/W	1 = Off 2 = On
I33wfmDisplayThumbHistoMixR	I33wfmDisplayTBL.8	INTEGER	R/W	1 = Off 2 = On
I33wfmDisplayThumbHistoMixG	I33wfmDisplayTBL.9	INTEGER	R/W	1 = Off 2 = On
I33wfmDisplayThumbHistoMixB	I33wfmDisplayTBL.10	INTEGER	R/W	1 = Off 2 = On
I33wfmMatrixTBL	I33wfmTBL.10	Aggregate	--	--
I33wfmMatrix	I33wfmMatrixTBL.1	INTEGER	R/W	1 = YCbCr 2 = GBR 3 = RGB 4 = Composite
I33wfmMatrixYgbr	I33wfmMatrixTBL.2	INTEGER	R/W	1 = On 2 = Off
I33wfmMatrixYrgb	I33wfmMatrixTBL.3	INTEGER	R/W	1 = On 2 = Off
I33wfmMatrixCompositeFormat	I33wfmMatrixTBL.4	INTEGER	R/W	1 = Auto 2 = NTSC 3 = PAL
I33wfmMatrixSetup	I33wfmMatrixTBL.5	INTEGER	R/W	1 = 0% 2 = 7.5%

Table 11-18 I33vectorTBL(4) group

MIB	OID	SYNTAX	ACCESS	VALUE/RANGE
I33vecIntenTBL	I33vectorTBL.1	Aggregate	-	-
I33vecIntenVector	I33vecIntenTBL.1	INTEGER	R/W	-128 to 127
I33vecColor	I33vecIntenTBL.2	INTEGER	R/W	1 = White 2 = Yellow 3 = Cyan 4 = Green 5 = Magenta 6 = Red 7 = Blue
I33vecColor2MapS1	I33vecIntenTBL.3	INTEGER	R/W	1 = White 2 = Yellow

11. ETHERNET REMOTE CONTROL

MIB	OID	SYNTAX	ACCESS	VALUE/RANGE
				3 = Cyan 4 = Green 5 = Magenta 6 = Red 7 = Blue
I33vecColor2MapS2	I33vecIntenTBL.4	INTEGER	R/W	1 = White 2 = Yellow 3 = Cyan 4 = Green 5 = Magenta 6 = Red 7 = Blue
I33vecIntenScale	I33vecIntenTBL.5	INTEGER	R/W	-8 to 7
I33vecScaleTBL	I33vectorTBL.2	Aggregate	-	-
I33vecScaleColor	I33vecScaleTBL.1	INTEGER	R/W	1 = White 2 = Yellow 3 = Cyan 4 = Green 5 = Magenta 6 = Red 7 = Blue
I33vecScaleIq	I33vecScaleTBL.2	INTEGER	R/W	1 = On 2 = Off
I33vecScaleVec	I33vecScaleTBL.3	INTEGER	R/W	1 = Auto 2 = BT-601 3 = BT-709
I33vecGainTBL	I33vectorTBL.3	Aggregate	-	-
I33vecGainMag	I33vecGainTBL.1	INTEGER	R/W	1 = X1 2 = X5 3 = IQ
I33vecGainVal	I33vecGainTBL.2	DisplayString	R/W	0.200 to 2.000
I33vecGainVar	I33vecGainTBL.3	INTEGER	R/W	1 = CAL 2 = VAR
I33vecLineSelTBL	I33vectorTBL.4	Aggregate	-	-
I33vecLineSelect	I33vecLineSelTBL.1	INTEGER	R/W	1 = On 2 = A-Ch 3 = B-Ch 4 = Both 5 = 3G-B 2Map Stream1 6 = 3G-B 2Map Stream2 7 = Off 8 = CINELITE
I33vecLineField	I33vecLineSelTBL.2	INTEGER INTEGER	R/W	1 = Field1 2 = Field2 3 = Frame
I33vecLineNumber	I33vecLineSelTBL.3	INTEGER	R/W	1 to 1125

11. ETHERNET REMOTE CONTROL

MIB	OID	SYNTAX	ACCESS	VALUE/RANGE
I33vecMode	I33vectorTBL.5	INTEGER	R/W	1 = Vector 2 = 5Bar
I33vec5BarTBL	I33vectorTBL.6	Aggregate	-	-
I33vec5BarScale	I33vec5BarTBL.1	INTEGER	R/W	1 = % 2 = mV
I33vec5BarSeaquence	I33vec5BarTBL.2	INTEGER	R/W	1 = GBR 2 = RGB
I33vec5BarYData	I33vec5BarTBL.3	DisplayString	R/O	Maximum Y value, minimum Y value
I33vec5BarGData	I33vec5BarTBL.4	DisplayString	R/O	Maximum G value, minimum G value
I33vec5BarBData	I33vec5BarTBL.5	DisplayString	R/O	Maximum B value, minimum B value
I33vec5BarRData	I33vec5BarTBL.6	DisplayString	R/O	Maximum R value, minimum R value
I33vec5BarCmpData	I33vec5BarTBL.7	DisplayString	R/O	Maximum CMP value, minimum CMP value
I33vecDisplayTBL	I33vectorTBL.7	Aggregate	-	-
I33vecDisplaySimul	I33vecDisplayTBL.1	INTEGER	R/W	1 = Mix 2 = Tile
I33vecDisplay2Map	I33vecDisplayTBL.2	INTEGER	R/W	1 = Stream1 2 = Stream2 3 = Mix 4 = Tile
I33vecDisplayThumbAudio	I33vecDisplayTBL.3	INTEGER	R/W	1 = Off 2 = On
I33vecDisplayThumbPicture	I33vecDisplayTBL.4	INTEGER	R/W	1 = Off 2 = On
I33vecDisplayThumbHisto	I33vecDisplayTBL.5	INTEGER	R/W	1 = Off 2 = On
I33vecDisplayThumbHistoForm	I33vecDisplayTBL.6	INTEGER	R/W	1 = Luma 2 = Align 3 = Mix
I33vecDisplayThumbHistoMixY	I33vecDisplayTBL.7	INTEGER	R/W	1 = Off 2 = On
I33vecDisplayThumbHistoMixR	I33vecDisplayTBL.8	INTEGER	R/W	1 = Off 2 = On
I33vecDisplayThumbHistoMixG	I33vecDisplayTBL.9	INTEGER	R/W	1 = Off 2 = On
I33vecDisplayThumbHistoMixB	I33vecDisplayTBL.10	INTEGER	R/W	1 = Off 2 = On
I33vecMatixTBL	I33vectorTBL.8	Aggregate	-	-
I33vecMatrix	I33vecMatixTBL.1	INTEGER	R/W	1 = Component 2 = Composite
I33vecMatrixCompositeFormat	I33vecMatixTBL.2	INTEGER	R/W	1 = Auto



11. ETHERNET REMOTE CONTROL

MIB	OID	SYNTAX	ACCESS	VALUE/RANGE
				2 = NTSC 3 = PAL
I33vecMatrixCompositeSetup	I33vecMatixTBL.3	INTEGER	R/W	1 = 0% 2 = 7.5%
I33vecMatrixColorbar	I33vecMatixTBL.4	INTEGER	R/W	1 = 100% 2 = 75%
I33vecAnalogTBL	I33vectorTBL.9	Aggregate	-	-
I33vecAnalogPhase	I33vecAnalogTBL.1	DisplayString	R/W	0.0 to 359.9
I33vecAnalogNtscDisplay	I33vecAnalogTBL.2	INTEGER	R/W	1 = On 2 = Off
I33vecSch	I33vecAnalogTBL.3	INTEGER	R/W	1 = On 2 = Off
I33vecSchData	I33vecAnalogTBL.4	DisplayString	R/O	SCH
I33vecPosH	I33vecAnalogTBL.5	INTEGER	R/W	-130 to +130
I33vecPosV	I33vecAnalogTBL.6	INTEGER	R/W	-130 to +130
I33vecMarkerTBL	I33vectorTBL.10	Aggregate	-	-
I33vecMarker	I33vecMarkerTBL.1	INTEGER	R/W	1 = On 2 = Off

Table 11-19 I33pictureTBL(5) group

MIB	OID	SYNTAX	ACCESS	VALUE/RANGE
I33picMonoColor	I33pictureTBL.1	INTEGER	R/W	1 = Mono 2 = Color
I33picChromaUp	I33pictureTBL.2	INTEGER	R/W	1 = Normal 2 = Up
I33picBrightness	I33pictureTBL.3	DisplayString	R/W	-50.0 to 50.0
I33picContrast	I33pictureTBL.4	DisplayString	R/W	0.0 to 200.0
I33picGainTBL	I33pictureTBL.5	Aggregate	-	-
I33picGainRed	I33picGainTBL.1	DisplayString	R/W	0.0 to 200.0
I33picGainGreen	I33picGainTBL.2	DisplayString	R/W	0.0 to 200.0
I33picGainBlue	I33picGainTBL.3	DisplayString	R/W	0.0 to 200.0
I33picGainChroma	I33picGainTBL.4	DisplayString	R/W	0.0 to 200.0
I33picBiasTBL	I33pictureTBL.6	Aggregate	-	-
I33picBiasRed	I33picBiasTBL.1	DisplayString	R/W	-50.0 to 50.0
I33picBiasGreen	I33picBiasTBL.2	DisplayString	R/W	-50.0 to 50.0
I33picBiasBlue	I33picBiasTBL.3	DisplayString	R/W	-50.0 to 50.0
I33picMarkerTBL	I33pictureTBL.7	Aggregate	-	-
I33picMarkerFrame	I33picMarkerTBL.1	INTEGER	R/W	1 = On 2 = Off
I33picMarkerCenter	I33picMarkerTBL.2	INTEGER	R/W	1 = On 2 = Off
I33picMarkerAspect	I33picMarkerTBL.3	INTEGER	R/W	1 = Off 2 = 14:9 3 = 13:9 4 = 16:9

## 11. ETHERNET REMOTE CONTROL

MIB	OID	SYNTAX	ACCESS	VALUE/RANGE
				5 = 4:3 6 = 2.39:1 7 = AFD
I33picMarkerAspectShadow	I33picMarkerTBL.4	INTEGER	R/W	0 to 100
I33picMarkerSafetyAction	I33picMarkerTBL.5	INTEGER	R/W	1 = ARIB 2 = SMPTE 3 = User1 4 = Off
I33picMarkerSafetyTitle	I33picMarkerTBL.6	INTEGER	R/W	1 = ARIB 2 = SMPTE 3 = User2 4 = Off
I33picMarkerSafetyUser1W	I33picMarkerTBL.7	INTEGER	R/W	0 to 100
I33picMarkerSafetyUser1H	I33picMarkerTBL.8	INTEGER	R/W	0 to 100
I33picMarkerSafetyUser2W	I33picMarkerTBL.9	INTEGER	R/W	0 to 100
I33picMarkerSafetyUser2H	I33picMarkerTBL.10	INTEGER	R/W	0 to 100
I33picLineSelTBL	I33pictureTBL.8	Aggregate	-	-
I33picLineSelect	I33picLineSelTBL.1	INTEGER	R/W	1 = On 2 = A-Ch 3 = B-Ch 4 = Both 5 = 3G-B 2Map Stream1 6 = 3G-B 2Map Stream2 7 = Off
I33picLineField	I33picLineSelTBL.2	INTEGER	R/W	1 = Field1 2 = Field2 3 = Frame
I33picLineNumber	I33picLineSelTBL.3	INTEGER	R/W	1 to 1125
I33picCineliteTBL	I33pictureTBL.9	Aggregate	-	-
I33picCineliteMode	I33picCineliteTBL.1	INTEGER	R/W	1 = Off 2 = fSTOP 3 = % 4 = CINEZONE
I33picCineliteFdFunc	I33picCineliteTBL.2	INTEGER	R/W	1 = Line 2 = Sample
I33picCineliteMeasPos	I33picCineliteTBL.3	INTEGER	R/W	1 = p1 2 = p2 3 = p3
I33picCineliteMeasSize	I33picCineliteTBL.4	INTEGER	R/W	1 = 1x1 2 = 3x3 3 = 9x9
I33picCineliteLine	I33picCineliteTBL.5	INTEGER	R/W	1 to 1125
I33picCineliteSample	I33picCineliteTBL.6	INTEGER	R/W	0 to 2749
I33picCineliteFstop18pRefset	I33picCineliteTBL.7	INTEGER	R/WO	1 = Set
I33picCineliteFstopGammaSel	I33picCineliteTBL.8	INTEGER	R/W	1 = 0.45 2 = User1

## 11. ETHERNET REMOTE CONTROL

MIB	OID	SYNTAX	ACCESS	VALUE/RANGE
				3 = User2 4 = User3 5 = User-A 6 = User-B 7 = User-C 8 = User-D 9 = User-E
I33picCinelitePercentUnit	I33picCineliteTBL.9	INTEGER	R/W	1 = Y% 2 = RGB% 3 = RGB255
I33picCineliteData	I33picCineliteTBL.10	DisplayString	R/O	CINELITE Data
I33picCineliteCinezoneForm	I33picCineliteTBL.11	INTEGER	R/W	1 = Gradate 2 = Step 3 = Search
I33picCineliteCinezoneUpper	I33picCineliteTBL.12	DisplayString	R/W	-6.3 to 109.4
I33picCineliteCinezoneLower	I33picCineliteTBL.13	DisplayString	R/W	-7.3 to 108.4
I33picCineliteCinezoneLevel	I33picCineliteTBL.14	DisplayString	R/W	-7.3 to 109.4
I33picCineliteAdvance	I33picCineliteTBL.15	INTEGER	R/W	1 = OFF 2 = P-V 3 = P-W 4 = P-V-W
I33picDisplayTBL	I33pictureTBL.10	Aggregate	-	-
I33picDisplaySize	I33picDisplayTBL.1	INTEGER	R/W	1 = Fit 2 = Real 3 = X2 4 = Full Frame
I33picDisplayGamutErr	I33picDisplayTBL.2	INTEGER	R/W	1 = Off 2 = White 3 = Red 4 = Mesh
I33picDisplayMode	I33picDisplayTBL.3	INTEGER	R/W	1 = 2D 2 = 3D Assist
I33picDisplaySimulDisp	I33picDisplayTBL.4	INTEGER	R/W	1 = Mix 2 = Tile
I33picDisplay2MapDisp	I33picDisplayTBL.5	INTEGER	R/W	1 = Stream1 2 = Stream2 3 = Mix 4 = Tile
I33picDisplayThumbAudio	I33picDisplayTBL.6	INTEGER	R/W	1 = Off 2 = On
I33picDisplayThumbWfm	I33picDisplayTBL.7	INTEGER	R/W	1 = Off 2 = On
I33picDisplayThumbHisto	I33picDisplayTBL.8	INTEGER	R/W	1 = Off 2 = On
I33picDisplayThumbHistoForm	I33picDisplayTBL.9	INTEGER	R/W	1 = Luma 2 = Align

11. ETHERNET REMOTE CONTROL

MIB	OID	SYNTAX	ACCESS	VALUE/RANGE
				3 = Mix
I33picDisplayThumbHistoMixY	I33picDisplayTBL.10	INTEGER	R/W	1 = Off 2 = On
I33picDisplayThumbHistoMixR	I33picDisplayTBL.11	INTEGER	R/W	1 = Off 2 = On
I33picDisplayThumbHistoMixG	I33picDisplayTBL.12	INTEGER	R/W	1 = Off 2 = On
I33picDisplayThumbHistoMixB	I33picDisplayTBL.13	INTEGER	R/W	1 = Off 2 = On
I33picDisplaySd	I33picDisplayTBL.14	INTEGER	R/W	1 = 4-3 2 = 16-9
I33picSImpsTBL	I33pictureTBL.11	Aggregate	-	-
I33picSImpsSmpte	I33picSImpsTBL.1	INTEGER	R/W	1 = Off 2 = On
I33picSImpsFormat	I33picSImpsTBL.2	INTEGER	R/W	1 = FMT-608-708 2 = FMT-608-608 3 = FMT-VBI 4 = FMT-708
I33picSImpsLanguage608	I33picSImpsTBL.3	INTEGER	R/W	1 = CC1 2 = CC2 3 = CC3 4 = CC4 5 = Text1 6 = Text2 7 = Text3 8 = Text4
I33picSImpsService708	I33picSImpsTBL.4	INTEGER	R/W	1 to 63

Table 11-20 I33statusTBL(6) group

MIB	OID	SYNTAX	ACCESS	VALUE/RANGE
I33status	I33statusTBL.1	INTEGER	R/WO	1 = Error Display
I33staDataTBL	I33statusTBL.2	Aggregate	-	-
I33staSignalData	I33staDataTBL.1	INTEGER	R/O	Signal Data
I33staLinkData	I33staDataTBL.2	INTEGER	R/O	Link Data
I33staFormatData	I33staDataTBL.3	DisplayString	R/O	Format Data
I33staEmbChData	I33staDataTBL.4	DisplayString	R/O	Audio Data
I33staLogTBL	I33statusTBL.3	Aggregate	-	-
I33staLog	I33staLogTBL.1	INTEGER	R/WO	1 = Log Display
I33staLogLog	I33staLogTBL.2	INTEGER	R/W	1 = Start 2 = Stop
I33staLogClear	I33staLogTBL.3	INTEGER	R/WO	1 = Log Clear
I33staLogMode	I33staLogTBL.4	INTEGER	R/W	1 = Over-Write 2 = Stop
I33staDumpTBL	I33statusTBL.4	Aggregate	-	-
I33staDump	I33staDumpTBL.1	INTEGER	R/WO	1 = Dump Display

11. ETHERNET REMOTE CONTROL

MIB	OID	SYNTAX	ACCESS	VALUE/RANGE
I33staDumpMode	I33staDumpTBL.2	INTEGER	R/W	1 = Run 2 = Hold
I33staDumpDisplay	I33staDumpTBL.3	INTEGER	R/W	1 = Serial 2 = Component 3 = Binary 4 = Link-A 5 = Link-B 6 = Link-AB 7 = Stream1 8 = Stream2 9 = Stream12 10 = S1 Serial 11 = S1 Component 12 = S1 Binary 13 = S2 Serial 14 = S2 Component 15 = S2 Binary
I33staDumpJump	I33staDumpTBL.4	INTEGER	R/W	1 = EAV 2 = SAV
I33staDumpLineNumber	I33staDumpTBL.5	INTEGER	R/W	1 to 1125
I33staDumpSample	I33staDumpTBL.6	INTEGER	R/W	0 to 2749
I33staExtrefTBL	I33statusTBL.5	Aggregate	-	-
I33staExtref	I33staExtrefTBL.1	INTEGER	R/WO	1 = ExtRef Display
I33staExtrefUserref	I33staExtrefTBL.2	INTEGER	R/WO	1 = UserRef
I33staExtrefDefault	I33staExtrefTBL.3	INTEGER	R/WO	1 = Default
I33staExtrefSelect	I33staExtrefTBL.4	INTEGER	R/W	1 = Ext 2 = Ch-A 3 = Link-A
I33staExtrefRefData	I33staExtrefTBL.5	INTEGER	R/O	1 = UserRef 2 = Default
I33staExtrefStatData	I33staExtrefTBL.6	INTEGER	R/O	1 = Int 2 = Ch-A 3 = Link-A 4 = HD 5 = BB 6 = No Signal
I33staExtrefHTimeData	I33staExtrefTBL.7	DisplayString	R/O	H Phase [us]
I33staExtrefHPixData	I33staExtrefTBL.8	DisplayString	R/O	H Phase [pixel/dot]
I33staExtrefVLinetData	I33staExtrefTBL.9	DisplayString	R/O	V Phase
I33staExtrefTotalData	I33staExtrefTBL.10	DisplayString	R/O	Total Phase
I33staAvPhaseTBL	I33statusTBL.6	Aggregate	-	-
I33staAvPhase	I33staAvPhaseTBL.1	INTEGER	R/WO	1 = AV Phase Display
I33staAvPhaseScale	I33staAvPhaseTBL.2	INTEGER	R/W	1 = 50ms

11. ETHERNET REMOTE CONTROL

MIB	OID	SYNTAX	ACCESS	VALUE/RANGE
				2 = 100ms 3 = 500ms 4 = 1000ms 5 = 2500ms
I33staAvPhaseCh1Data	I33staAvPhaseTBL.3	DisplayString	R/O	Ch1 Data
I33staAvPhaseCh2Data	I33staAvPhaseTBL.4	DisplayString	R/O	Ch2 Data
I33staAvPhaseCh3Data	I33staAvPhaseTBL.5	DisplayString	R/O	Ch3 Data
I33staAvPhaseCh4Data	I33staAvPhaseTBL.6	DisplayString	R/O	Ch4 Data
I33staAvPhaseCh5Data	I33staAvPhaseTBL.7	DisplayString	R/O	Ch5 Data
I33staAvPhaseCh6Data	I33staAvPhaseTBL.8	DisplayString	R/O	Ch6 Data
I33staAvPhaseCh7Data	I33staAvPhaseTBL.9	DisplayString	R/O	Ch7 Data
I33staAvPhaseCh8Data	I33staAvPhaseTBL.10	DisplayString	R/O	Ch8 Data
I33staAvPhaseThumbnailAudio	I33staAvPhaseTBL.11	INTEGER	R/W	1 = Off 2 = On
I33staAvPhaseThumbnailPicture	I33staAvPhaseTBL.12	INTEGER	R/W	1 = Off 2 = On
I33staAvPhaseLine	I33staAvPhaseTBL.14	DisplayString	R/W	0 to 100
I33staAvPhaseLeft	I33staAvPhaseTBL.15	DisplayString	R/W	0 to 99
I33staAvPhaseRight	I33staAvPhaseTBL.16	DisplayString	R/W	0 to 99
I33staAvPhaseVideo	I33staAvPhaseTBL.17	DisplayString	R/W	25 to 100
I33staAvPhaseAudio	I33staAvPhaseTBL.18	DisplayString	R/W	-30 to 0
I33staAvPhaseMesGate	I33staAvPhaseTBL.20	INTEGER	R/W	1 = ON 2 = OFF
I33staAvPhaseMesGateTime	I33staAvPhaseTBL.21	DisplayString	R/W	100 to 1500
I33staAncpacketTBL	I33statusTBL.7	Aggregate	-	-
I33staAncpacket	I33staAncpacketTBL.1	INTEGER	R/WO	1 = ANC Packet Display
I33staAncpacketAudioCtrlData	I33staAncpacketTBL.2	INTEGER	R/O	1 = Detect 2 = Missing 3 = Unmeasurable
I33staAncpacketEdhData	I33staAncpacketTBL.3	INTEGER	R/O	1 = Detect 2 = Missing 3 = Unmeasurable
I33staAncpacketLtcData	I33staAncpacketTBL.4	INTEGER	R/O	1 = Detect 2 = Missing 3 = Unmeasurable
I33staAncpacketVitcData	I33staAncpacketTBL.5	INTEGER	R/O	1 = Detect 2 = Missing 3 = Unmeasurable
I33staAncpacketPayload1Data	I33staAncpacketTBL.6	INTEGER	R/O	1 = Detect 2 = Missing 3 = Unmeasurable
I33staAncpacketPayload2Data	I33staAncpacketTBL.7	INTEGER	R/O	1 = Detect 2 = Missing 3 = Unmeasurable

11. ETHERNET REMOTE CONTROL

MIB	OID	SYNTAX	ACCESS	VALUE/RANGE
I33staAncpacketEia708_708Data	I33staAncpacketTBL.8	INTEGER	R/O	1 = Detect 2 = Missing 3 = Unmeasurable
I33staAncpacketEia708_608Data	I33staAncpacketTBL.9	INTEGER	R/O	1 = Detect 2 = Missing 3 = Unmeasurable
I33staAncpacketEia608Data	I33staAncpacketTBL.10	INTEGER	R/O	1 = Detect 2 = Missing 3 = Unmeasurable
I33staAncpacketProgramData	I33staAncpacketTBL.11	INTEGER	R/O	1 = Detect 2 = Missing 3 = Unmeasurable
I33staAncpacketDataBroadcastData	I33staAncpacketTBL.12	INTEGER	R/O	1 = Detect 2 = Missing 3 = Unmeasurable
I33staAncpacketVbiData	I33staAncpacketTBL.13	INTEGER	R/O	1 = Detect 2 = Missing 3 = Unmeasurable
I33staAncpacketAfdData	I33staAncpacketTBL.14	INTEGER	R/O	1 = Detect 2 = Missing 3 = Unmeasurable
I33staAncpacketJpnCc1Data	I33staAncpacketTBL.15	INTEGER	R/O	1 = Detect 2 = Missing 3 = Unmeasurable
I33staAncpacketJpnCc2Data	I33staAncpacketTBL.16	INTEGER	R/O	1 = Detect 2 = Missing 3 = Unmeasurable
I33staAncpacketJpnCc3Data	I33staAncpacketTBL.17	INTEGER	R/O	1 = Detect 2 = Missing 3 = Unmeasurable
I33staAncpacketNetQData	I33staAncpacketTBL.18	INTEGER	R/O	1 = Detect 2 = Missing 3 = Unmeasurable
I33staAncpacketTriggerData	I33staAncpacketTBL.19	INTEGER	R/O	1 = Detect 2 = Missing 3 = Unmeasurable
I33staAncpacketUser1Data	I33staAncpacketTBL.20	INTEGER	R/O	1 = Detect 2 = Missing 3 = Unmeasurable
I33staAncpacketUser2Data	I33staAncpacketTBL.21	INTEGER	R/O	1 = Detect 2 = Missing 3 = Unmeasurable
I33staAncPktTBL	I33statusTBL.8	Aggregate	-	-
I33staAncPktPayloadId	I33staAncPktTBL.1	INTEGER	R/WO	1 = ANC Payload ID Display
I33staAncPktPayloadIdStream	I33staAncPktTBL.2	INTEGER	R/W	1 = Stream1

11. ETHERNET REMOTE CONTROL

MIB	OID	SYNTAX	ACCESS	VALUE/RANGE
				2 = Stream2
I33staAncPktPayloadIdLink	I33staAncPktTBL.3	INTEGER	R/W	1 = Link-A 2 = Link-B
I33staAncPktPayloadIdData	I33staAncPktTBL.4	DisplayString	R/O	Payload ID
I33staAncPktAudioCtrl	I33staAncPktTBL.5	INTEGER	R/WO	1 = ANC Audio Ctrl Display
I33staAncPktAudioCtrlDisplay	I33staAncPktTBL.6	INTEGER	R/W	1 = Text 2 = Dump
I33staAncPktAudioCtrlMode	I33staAncPktTBL.7	INTEGER	R/W	1 = Hex 2 = Binary
I33staAncPktAudioCtrlGroup	I33staAncPktTBL.8	INTEGER	R/W	1 to 4
I33staAncPktAudioCtrlStream	I33staAncPktTBL.9	INTEGER	R/W	1 = Stream1 2 = Stream2
I33staAncPktAribNetq	I33staAncPktTBL.10	INTEGER	R/WO	1 = ANC Net-Q Display
I33staAncPktAribNetqBitQ1	I33staAncPktTBL.11	INTEGER	R/W	1 = On 2 = Off
I33staAncPktAribNetqBitQ2	I33staAncPktTBL.12	INTEGER	R/W	1 = On 2 = Off
I33staAncPktAribNetqBitQ3	I33staAncPktTBL.13	INTEGER	R/W	1 = On 2 = Off
I33staAncPktAribNetqBitQ4	I33staAncPktTBL.14	INTEGER	R/W	1 = On 2 = Off
I33staAncPktAribNetqBitQ5	I33staAncPktTBL.15	INTEGER	R/W	1 = On 2 = Off
I33staAncPktAribNetqBitQ6	I33staAncPktTBL.16	INTEGER	R/W	1 = On 2 = Off
I33staAncPktAribNetqBitQ7	I33staAncPktTBL.17	INTEGER	R/W	1 = On 2 = Off
I33staAncPktAribNetqBitQ8	I33staAncPktTBL.18	INTEGER	R/W	1 = On 2 = Off
I33staAncPktAribNetqBitQ9	I33staAncPktTBL.19	INTEGER	R/W	1 = On 2 = Off
I33staAncPktAribNetqBitQ10	I33staAncPktTBL.20	INTEGER	R/W	1 = On 2 = Off
I33staAncPktAribNetqBitQ11	I33staAncPktTBL.21	INTEGER	R/W	1 = On 2 = Off
I33staAncPktAribNetqBitQ12	I33staAncPktTBL.22	INTEGER	R/W	1 = On 2 = Off
I33staAncPktAribNetqBitQ13	I33staAncPktTBL.23	INTEGER	R/W	1 = On 2 = Off
I33staAncPktAribNetqBitQ14	I33staAncPktTBL.24	INTEGER	R/W	1 = On 2 = Off
I33staAncPktAribNetqBitQ15	I33staAncPktTBL.25	INTEGER	R/W	1 = On



## 11. ETHERNET REMOTE CONTROL

MIB	OID	SYNTAX	ACCESS	VALUE/RANGE
				2 = Off
I33staAncPktAribNetqBitQ16	I33staAncPktTBL.26	INTEGER	R/W	1 = On 2 = Off
I33staAncPktAribNetqBitQ17	I33staAncPktTBL.27	INTEGER	R/W	1 = On 2 = Off
I33staAncPktAribNetqBitQ18	I33staAncPktTBL.28	INTEGER	R/W	1 = On 2 = Off
I33staAncPktAribNetqBitQ19	I33staAncPktTBL.29	INTEGER	R/W	1 = On 2 = Off
I33staAncPktAribNetqBitQ20	I33staAncPktTBL.30	INTEGER	R/W	1 = On 2 = Off
I33staAncPktAribNetqBitQ21	I33staAncPktTBL.31	INTEGER	R/W	1 = On 2 = Off
I33staAncPktAribNetqBitQ22	I33staAncPktTBL.32	INTEGER	R/W	1 = On 2 = Off
I33staAncPktAribNetqBitQ23	I33staAncPktTBL.33	INTEGER	R/W	1 = On 2 = Off
I33staAncPktAribNetqBitQ24	I33staAncPktTBL.34	INTEGER	R/W	1 = On 2 = Off
I33staAncPktAribNetqBitQ25	I33staAncPktTBL.35	INTEGER	R/W	1 = On 2 = Off
I33staAncPktAribNetqBitQ26	I33staAncPktTBL.36	INTEGER	R/W	1 = On 2 = Off
I33staAncPktAribNetqBitQ27	I33staAncPktTBL.37	INTEGER	R/W	1 = On 2 = Off
I33staAncPktAribNetqBitQ28	I33staAncPktTBL.38	INTEGER	R/W	1 = On 2 = Off
I33staAncPktAribNetqBitQ29	I33staAncPktTBL.39	INTEGER	R/W	1 = On 2 = Off
I33staAncPktAribNetqBitQ30	I33staAncPktTBL.40	INTEGER	R/W	1 = On 2 = Off
I33staAncPktAribNetqBitQ31	I33staAncPktTBL.41	INTEGER	R/W	1 = On 2 = Off
I33staAncPktAribNetqBitQ32	I33staAncPktTBL.42	INTEGER	R/W	1 = On 2 = Off
I33staAncPktAribNetqBitS1	I33staAncPktTBL.43	INTEGER	R/W	1 = On 2 = Off
I33staAncPktAribNetqBitS2	I33staAncPktTBL.44	INTEGER	R/W	1 = On 2 = Off
I33staAncPktAribNetqBitS3	I33staAncPktTBL.45	INTEGER	R/W	1 = On 2 = Off
I33staAncPktAribNetqBitS4	I33staAncPktTBL.46	INTEGER	R/W	1 = On 2 = Off
I33staAncPktAribNetqBitS5	I33staAncPktTBL.47	INTEGER	R/W	1 = On 2 = Off

11. ETHERNET REMOTE CONTROL

MIB	OID	SYNTAX	ACCESS	VALUE/RANGE
I33staAncPktAribNetqBitS6	I33staAncPktTBL.48	INTEGER	R/W	1 = On 2 = Off
I33staAncPktAribNetqBitS7	I33staAncPktTBL.49	INTEGER	R/W	1 = On 2 = Off
I33staAncPktAribNetqBitS8	I33staAncPktTBL.50	INTEGER	R/W	1 = On 2 = Off
I33staAncPktAribNetqBitS9	I33staAncPktTBL.51	INTEGER	R/W	1 = On 2 = Off
I33staAncPktAribNetqBitS10	I33staAncPktTBL.52	INTEGER	R/W	1 = On 2 = Off
I33staAncPktAribNetqBitS11	I33staAncPktTBL.53	INTEGER	R/W	1 = On 2 = Off
I33staAncPktAribNetqBitS12	I33staAncPktTBL.54	INTEGER	R/W	1 = On 2 = Off
I33staAncPktAribNetqBitS13	I33staAncPktTBL.55	INTEGER	R/W	1 = On 2 = Off
I33staAncPktAribNetqBitS14	I33staAncPktTBL.56	INTEGER	R/W	1 = On 2 = Off
I33staAncPktAribNetqBitS15	I33staAncPktTBL.57	INTEGER	R/W	1 = On 2 = Off
I33staAncPktAribNetqBitS16	I33staAncPktTBL.58	INTEGER	R/W	1 = On 2 = Off
I33staAncPktAribNetqStationData	I33staAncPktTBL.59	DisplayString	R/O	Station Code
I33staAncPktAribNetqVCurrData	I33staAncPktTBL.60	DisplayString	R/O	Video Current
I33staAncPktAribNetqVNextData	I33staAncPktTBL.61	DisplayString	R/O	Video Next
I33staAncPktAribNetqACurrData	I33staAncPktTBL.62	DisplayString	R/O	Audio Current
I33staAncPktAribNetqANextData	I33staAncPktTBL.63	DisplayString	R/O	Audio Next
I33staAncPktAribNetqDCurrData	I33staAncPktTBL.64	DisplayString	R/O	Down Mix Current
I33staAncPktAribNetqDNextData	I33staAncPktTBL.65	DisplayString	R/O	Down Mix Next
I33staAncPktSmpteAfd	I33staAncPktTBL.66	INTEGER	R/WO	1 = ANC AFD Display
I33staAncPktSmpteAfdCodeData	I33staAncPktTBL.67	DisplayString	R/O	AFD Code
I33staAncPktSmpteAfdFrameData	I33staAncPktTBL.68	DisplayString	R/O	Coded Frame
I33staAncPktSmpteAfdBarFlgData	I33staAncPktTBL.69	DisplayString	R/O	Bar Data Flags
I33staAncPktSmpteAfdBarVal1Data	I33staAncPktTBL.70	DisplayString	R/O	Bar Data Value1
I33staAncPktSmpteAfdBarVal2Data	I33staAncPktTBL.71	DisplayString	R/O	Bar Data Value2
I33staErrorSdiTBL	I33statusTBL.9	Aggregate	-	-
I33staErrorSdiCounterMode	I33staErrorSdiTBL.1	INTEGER	R/W	1 = Sec. 2 = Field
I33staErrorSdiTrs	I33staErrorSdiTBL.2	INTEGER	R/W	1 = On 2 = Off
I33staErrorSdiHdLine	I33staErrorSdiTBL.3	INTEGER	R/W	1 = On 2 = Off
I33staErrorSdiHdCrc	I33staErrorSdiTBL.4	INTEGER	R/W	1 = On 2 = Off

11. ETHERNET REMOTE CONTROL

MIB	OID	SYNTAX	ACCESS	VALUE/RANGE
I33staErrorSdiSdEdh	I33staErrorSdiTBL.5	INTEGER	R/W	1 = On 2 = Off
I33staErrorSdiIllegalCode	I33staErrorSdiTBL.6	INTEGER	R/W	1 = On 2 = Off
I33staErrorAncTBL	I33statusTBL.10	Aggregate	-	-
I33staErrorAncParity	I33staErrorAncTBL.1	INTEGER	R/W	1 = On 2 = Off
I33staErrorAncChecksum	I33staErrorAncTBL.2	INTEGER	R/W	1 = On 2 = Off
I33staErrorAudTBL	I33statusTBL.11	Aggregate	-	-
I33staErrorAudioBch	I33staErrorAudTBL.1	INTEGER	R/W	1 = On 2 = Off
I33staErrorAudioDbn	I33staErrorAudTBL.2	INTEGER	R/W	1 = On 2 = Off
I33staErrorAudioParity	I33staErrorAudTBL.3	INTEGER	R/W	1 = On 2 = Off
I33staErrorAudioInhibit	I33staErrorAudTBL.4	INTEGER	R/W	1 = On 2 = Off
I33staErrorAudioSample	I33staErrorAudTBL.5	INTEGER	R/W	1 = On 2 = Off
I33staErrorGamutTBL	I33statusTBL.12	Aggregate	-	-
I33staErrorGamutLpf	I33staErrorGamutTBL.1	INTEGER	R/W	1 = HD1MHz- SD1MHz 2 = HD2.8MHz- SD1MHz 3 = Off
I33staErrorGamut	I33staErrorGamutTBL.2	INTEGER	R/W	1 = On 2 = Off
I33staErrorGamutUpper	I33staErrorGamutTBL.3	DisplayString	R/W	90.8 to 109.4
I33staErrorGamutLower	I33staErrorGamutTBL.4	DisplayString	R/W	-7.2 to 6.1
I33staErrorGamutArea	I33staErrorGamutTBL.5	DisplayString	R/W	0.0 to 5.0
I33staErrorGamutDuration	I33staErrorGamutTBL.6	INTEGER	R/W	1 to 60
I33staErrorCGamut	I33staErrorGamutTBL.7	INTEGER	R/W	1 = On 2 = Off
I33staErrorCGamutSetup	I33staErrorGamutTBL.8	INTEGER	R/W	1 = 0% 2 = 7.5%
I33staErrorCGamutUpper	I33staErrorGamutTBL.9	DisplayString	R/W	90.0 to 135.0
I33staErrorCGamutLower	I33staErrorGamutTBL.10	DisplayString	R/W	-40.0 to 20.0
I33staErrorCGamutArea	I33staErrorGamutTBL.11	DisplayString	R/W	0.0 to 5.0
I33staErrorCGamutDuration	I33staErrorGamutTBL.12	INTEGER	R/W	1 to 60
I33staErrorFreezeTBL	I33statusTBL.13	Aggregate	-	-
I33staErrorFreeze	I33staErrorFreezeTBL.1	INTEGER	R/W	1 = On 2 = Off
I33staErrorFreezeUpper	I33staErrorFreezeTBL.2	INTEGER	R/W	0 to 100
I33staErrorFreezeLower	I33staErrorFreezeTBL.3	INTEGER	R/W	0 to 100

11. ETHERNET REMOTE CONTROL

MIB	OID	SYNTAX	ACCESS	VALUE/RANGE
I33staErrorFreezeLeft	I33staErrorFreezeTBL.4	INTEGER	R/W	0 to 100
I33staErrorFreezeRight	I33staErrorFreezeTBL.5	INTEGER	R/W	0 to 100
I33staErrorFreezeDuration	I33staErrorFreezeTBL.6	INTEGER	R/W	2 to 300
I33staErrorBlackTBL	I33statusTBL.14	Aggregate	-	-
I33staErrorBlack	I33staErrorBlackTBL.1	INTEGER	R/W	1 = On 2 = Off
I33staErrorBlackLevel	I33staErrorBlackTBL.2	INTEGER	R/W	0 to 100
I33staErrorBlackArea	I33staErrorBlackTBL.3	INTEGER	R/W	1 to 100
I33staErrorBlackDuration	I33staErrorBlackTBL.4	INTEGER	R/W	1 to 300
I33staErrorLevelTBL	I33statusTBL.15	Aggregate	-	-
I33staErrorLevel	I33staErrorLevelTBL.1	INTEGER	R/W	1 = On 2 = Off
I33staErrorLevelRumaUpper	I33staErrorLevelTBL.2	INTEGER	R/W	-51 to 766
I33staErrorLevelRumaLower	I33staErrorLevelTBL.3	INTEGER	R/W	-51 to 766
I33staErrorLevelChromaUpper	I33staErrorLevelTBL.4	INTEGER	R/W	-400 to 399
I33staErrorLevelChromaLower	I33staErrorLevelTBL.5	INTEGER	R/W	-400 to 399
I33staErrorCableTBL	I33statusTBL.16	Aggregate	-	-
I33staErrorCable	I33staErrorCableTBL.1	INTEGER	R/W	1 = On 2 = Off
I33staErrorCable3g	I33staErrorCableTBL.2	INTEGER	R/W	1 = LS-5CFB 2 = 1694A
I33staErrorCableHd	I33staErrorCableTBL.3	INTEGER	R/W	1 = LS-5CFB 2 = 1694A
I33staErrorCableSd	I33staErrorCableTBL.4	INTEGER	R/W	1 = L-5C2V 2 = 8281
I33staErrorCableErr3g	I33staErrorCableTBL.5	INTEGER	R/W	10 to 105
I33staErrorCableWar3g	I33staErrorCableTBL.6	INTEGER	R/W	10 to 105
I33staErrorCableErrHd	I33staErrorCableTBL.7	INTEGER	R/W	5 to 130
I33staErrorCableWarHd	I33staErrorCableTBL.8	INTEGER	R/W	5 to 130
I33staErrorCableErrSd	I33staErrorCableTBL.9	INTEGER	R/W	50 to 300
I33staErrorCableWarSd	I33staErrorCableTBL.10	INTEGER	R/W	50 to 300

Table 11-21 I33eyeTBL(7) group

MIB	OID	SYNTAX	ACCESS	VALUE/RANGE
I33eyeMode	I33eyeTBL.1	INTEGER	R/W	1 = Eye 2 = Jitter
I33eyeIntenTBL	I33eyeTBL.2	Aggregate	-	-
I33eyeIntenEye	I33eyeIntenTBL.1	INTEGER	R/W	-128 to 127
I33eyeIntenScale	I33eyeIntenTBL.2	INTEGER	R/W	-8 to 7
I33eyeColorTBL	I33eyeTBL.3	Aggregate	-	-
I33eyeColorEye	I33eyeColorTBL.1	INTEGER	R/W	1 = White 2 = Yellow 3 = Cyan 4 = Green 5 = Magenta

11. ETHERNET REMOTE CONTROL

MIB	OID	SYNTAX	ACCESS	VALUE/RANGE
				6 = Red 7 = Blue
I33eyeColorScale	I33eyeColorTBL.2	INTEGER	R/W	1 = White 2 = Yellow 3 = Cyan 4 = Green 5 = Magenta 6 = Red 7 = Blue
I33eyeGainTBL	I33eyeTBL.4	Aggregate	-	-
I33eyeGainVar	I33eyeGainTBL.1	INTEGER	R/W	1 = Cal 2 = Var
I33eyeGainVal	I33eyeGainTBL.2	DisplayString	R/W	0.50 to 2.00
I33eyeSweepSweep	I33eyeTBL.5	INTEGER	R/W	1 = 2UI 2 = 4UI 3 = 16UI
I33eyeFilter	I33eyeTBL.6	INTEGER	R/W	1 = 100kHz 2 = 1kHz 3 = 100Hz 4 = 10Hz 5 = Timing 6 = Alignment
I33eyeSubItem	I33eyeTBL.7	INTEGER	R/W	1 = Jitter 2 = Off
I33eyeLinkSelect	I33eyeTBL.8	INTEGER	R/W	1 = Link-A 2 = Link-B
I33eyeJitterTBL	I33eyeTBL.9	Aggregate	-	-
I33eyeJitterIntenTBL	I33eyeJitterTBL.1	Aggregate	-	-
I33eyeJitterIntenEye	I33eyeJitterIntenTBL.1	INTEGER	R/W	-128 to 127
I33eyeJitterIntenScale	I33eyeJitterIntenTBL.2	INTEGER	R/W	-8 to 7
I33eyeJitterColorTBL	I33eyeJitterTBL.2	Aggregate	-	-
I33eyeJitterColorEye	I33eyeJitterColorTBL.1	INTEGER	R/W	1 = White 2 = Yellow 3 = Cyan 4 = Green 5 = Magenta 6 = Red 7 = Blue
I33eyeJitterColorScale	I33eyeJitterColorTBL.2	INTEGER	R/W	1 = White 2 = Yellow 3 = Cyan 4 = Green 5 = Magenta 6 = Red 7 = Blue
I33eyeJitterGain	I33eyeJitterTBL.3	INTEGER	R/W	1 = X1

11. ETHERNET REMOTE CONTROL

MIB	OID	SYNTAX	ACCESS	VALUE/RANGE
				2 = X2 3 = X8
I33eyeJitterSweep	I33eyeJitterTBL.4	INTEGER	R/W	1 = 1H 2 = 2H 3 = 1V 4 = 2V
I33eyeJitterFilter	I33eyeJitterTBL.5	INTEGER	R/W	1 = 100kHz 2 = 1kHz 3 = 100Hz 4 = 10Hz 5 = Timing 6 = Alignment
I33eyeJitterPeakHold	I33eyeJitterTBL.6	INTEGER	R/W	1 = On 2 = Off
I33eyeJitterPeakHoldClear	I33eyeJitterTBL.7	INTEGER	R/WO	1 = Clear
I33eyeJitterSubItem	I33eyeJitterTBL.8	INTEGER	R/W	1 = Eye 2 = Off
I33eyeErrorTBL	I33eyeTBL.10	Aggregate	-	-
I33eyeError3GTBL	I33eyeErrorTBL.1	Aggregate	-	-
I33eyeError3GAmp	I33eyeError3GTBL.1	INTEGER	R/W	1 = On 2 = Off
I33eyeError3GAmpUpper	I33eyeError3GTBL.2	INTEGER	R/W	80 to 140
I33eyeError3GAmpLower	I33eyeError3GTBL.3	INTEGER	R/W	40 to 100
I33eyeError3GRise	I33eyeError3GTBL.4	INTEGER	R/W	1 = On 2 = Off
I33eyeError3GRiseMax	I33eyeError3GTBL.5	INTEGER	R/W	40 to 140
I33eyeError3GFall	I33eyeError3GTBL.6	INTEGER	R/W	1 = On 2 = Off
I33eyeError3GFallMax	I33eyeError3GTBL.7	INTEGER	R/W	40 to 140
I33eyeError3GDelta	I33eyeError3GTBL.8	INTEGER	R/W	1 = On 2 = Off
I33eyeError3GDeltaMax	I33eyeError3GTBL.9	INTEGER	R/W	40 to 140
I33eyeError3GTimingJit	I33eyeError3GTBL.10	INTEGER	R/W	1 = On 2 = Off
I33eyeError3GTimingJitMax	I33eyeError3GTBL.11	INTEGER	R/W	10 to 200
I33eyeError3GCurrentJit	I33eyeError3GTBL.12	INTEGER	R/W	1 = On 2 = Off
I33eyeError3GCurrentJitMax	I33eyeError3GTBL.13	INTEGER	R/W	10 to 200
I33eyeError3GOverShootRise	I33eyeError3GTBL.14	INTEGER	R/W	1 = On 2 = Off
I33eyeError3GOverShootRiseMax	I33eyeError3GTBL.15	INTEGER	R/W	0 to 200
I33eyeError3GOverShootFall	I33eyeError3GTBL.16	INTEGER	R/W	1 = On 2 = Off
I33eyeError3GOverShootFallMax	I33eyeError3GTBL.17	INTEGER	R/W	0 to 200
I33eyeErrorHdTBL	I33eyeErrorTBL.2	Aggregate	-	-

## 11. ETHERNET REMOTE CONTROL

MIB	OID	SYNTAX	ACCESS	VALUE/RANGE
I33eyeErrorHdAmp	I33eyeErrorHdTBL.1	INTEGER	R/W	1 = On 2 = Off
I33eyeErrorHdAmpUpper	I33eyeErrorHdTBL.2	INTEGER	R/W	80 to 140
I33eyeErrorHdAmpLower	I33eyeErrorHdTBL.3	INTEGER	R/W	40 to 100
I33eyeErrorHdRise	I33eyeErrorHdTBL.4	INTEGER	R/W	1 = On 2 = Off
I33eyeErrorHdRiseMax	I33eyeErrorHdTBL.5	INTEGER	R/W	40 to 140
I33eyeErrorHdFall	I33eyeErrorHdTBL.6	INTEGER	R/W	1 = On 2 = Off
I33eyeErrorHdFallMax	I33eyeErrorHdTBL.7	INTEGER	R/W	40 to 140
I33eyeErrorHdDelta	I33eyeErrorHdTBL.8	INTEGER	R/W	1 = On 2 = Off
I33eyeErrorHdDeltaMax	I33eyeErrorHdTBL.9	INTEGER	R/W	40 to 140
I33eyeErrorHdTimingJit	I33eyeErrorHdTBL.10	INTEGER	R/W	1 = On 2 = Off
I33eyeErrorHdTimingJitMax	I33eyeErrorHdTBL.11	INTEGER	R/W	10 to 200
I33eyeErrorHdCurrentJit	I33eyeErrorHdTBL.12	INTEGER	R/W	1 = On 2 = Off
I33eyeErrorHdCurrentJitMax	I33eyeErrorHdTBL.13	INTEGER	R/W	10 to 200
I33eyeErrorHdOverShootRise	I33eyeErrorHdTBL.14	INTEGER	R/W	1 = On 2 = Off
I33eyeErrorHdOverShootRiseMax	I33eyeErrorHdTBL.15	INTEGER	R/W	0 to 200
I33eyeErrorHdOverShootFall	I33eyeErrorHdTBL.16	INTEGER	R/W	1 = On 2 = Off
I33eyeErrorHdOverShootFallMax	I33eyeErrorHdTBL.17	INTEGER	R/W	0 to 200
I33eyeErrorSdTBL	I33eyeErrorTBL.3	Aggregate	-	-
I33eyeErrorSdAmp	I33eyeErrorSdTBL.1	INTEGER	R/W	1 = On 2 = Off
I33eyeErrorSdAmpUpper	I33eyeErrorSdTBL.2	INTEGER	R/W	80 to 140
I33eyeErrorSdAmpLower	I33eyeErrorSdTBL.3	INTEGER	R/W	40 to 100
I33eyeErrorSdRise	I33eyeErrorSdTBL.4	INTEGER	R/W	1 = On 2 = Off
I33eyeErrorSdRiseMax	I33eyeErrorSdTBL.5	INTEGER	R/W	40 to 140
I33eyeErrorSdFall	I33eyeErrorSdTBL.6	INTEGER	R/W	1 = On 2 = Off
I33eyeErrorSdFallMax	I33eyeErrorSdTBL.7	INTEGER	R/W	40 to 140
I33eyeErrorSdDelta	I33eyeErrorSdTBL.8	INTEGER	R/W	1 = On 2 = Off
I33eyeErrorSdDeltaMax	I33eyeErrorSdTBL.9	INTEGER	R/W	40 to 140
I33eyeErrorSdTimingJit	I33eyeErrorSdTBL.10	INTEGER	R/W	1 = On 2 = Off
I33eyeErrorSdTimingJitMax	I33eyeErrorSdTBL.11	INTEGER	R/W	10 to 200
I33eyeErrorSdCurrentJit	I33eyeErrorSdTBL.12	INTEGER	R/W	1 = On 2 = Off
I33eyeErrorSdCurrentJitMax	I33eyeErrorSdTBL.13	INTEGER	R/W	10 to 200

## 11. ETHERNET REMOTE CONTROL

MIB	OID	SYNTAX	ACCESS	VALUE/RANGE
I33eyeErrorSdOverShootRise	I33eyeErrorSdTBL.14	INTEGER	R/W	1 = On 2 = Off
I33eyeErrorSdOverShootRiseMax	I33eyeErrorSdTBL.15	INTEGER	R/W	0 to 200
I33eyeErrorSdOverShootFall	I33eyeErrorSdTBL.16	INTEGER	R/W	1 = On 2 = Off
I33eyeErrorSdOverShootFallMax	I33eyeErrorSdTBL.17	INTEGER	R/W	0 to 200
I33eyeErrorDcTBL	I33eyeErrorTBL.4	Aggregate	-	-
I33eyeErrorDc	I33eyeErrorDcTBL.1	INTEGER	R/W	1 = On 2 = Off
I33eyeErrorDcUpper	I33eyeErrorDcTBL.2	INTEGER	R/W	0 to 100
I33eyeErrorDcLower	I33eyeErrorDcTBL.3	INTEGER	R/W	0 to 100
I33eyeMonTBL	I33eyeTBL.11	Aggregate	-	-
I33eyeAmpData	I33eyeMonTBL.1	DisplayString	R/O	Amp
I33eyeTrData	I33eyeMonTBL.2	DisplayString	R/O	Tr
I33eyeTfData	I33eyeMonTBL.3	DisplayString	R/O	Tf
I33eyeTJData	I33eyeMonTBL.4	DisplayString	R/O	T.J
I33eyeCJData	I33eyeMonTBL.5	DisplayString	R/O	C.J
I33eyeORData	I33eyeMonTBL.6	DisplayString	R/O	Or
I33eyeOFData	I33eyeMonTBL.7	DisplayString	R/O	Of
I33eyeDCData	I33eyeMonTBL.8	DisplayString	R/O	Dc

Table 11-22 I33audioTBL(8) group

MIB	OID	SYNTAX	ACCESS	VALUE/RANGE
I33audSourceTBL	I33audioTBL.1	Aggregate	-	-
I33audSourceInput	I33audSourceTBL.1	INTEGER	R/W	1 = SDI 2 = Ext Digital 3 = Ext Analog
I33audSourceSdi1stGrp	I33audSourceTBL.2	INTEGER	R/W	1 to 4
I33audSourceSdi2ndGrp	I33audSourceTBL.3	INTEGER	R/W	1 to 4
I33audSourceExtDigiChSel	I33audSourceTBL.4	INTEGER	R/W	1 = Group-A 2 = Group-B
I33audDisplayMode	I33audioTBL.2	INTEGER	R/W	1 = Lissajous 2 = Surround 3 = Status 4 = Loudness 5 = Meter
I33audMeterTBL	I33audioTBL.3	Aggregate	-	-
I33audMeterDRange	I33audMeterTBL.1	INTEGER	R/W	1 = -60dBFS 2 = -90dBFS 3 = MAG
I33audMeterResponse	I33audMeterTBL.2	INTEGER	R/W	1 = True Peak 2 = PPM 3 = VU
I33audMeterResponsePPM	I33audMeterTBL.3	INTEGER	R/W	1 = PPM1 2 = PPM2



## 11. ETHERNET REMOTE CONTROL

MIB	OID	SYNTAX	ACCESS	VALUE/RANGE
I33audMeterResponseVU	I33audMeterTBL.4	INTEGER	R/W	1 = TRUE 2 = PPM1 3 = PPM2
I33audMeterPeakHold	I33audMeterTBL.5	INTEGER	R/W	1 = 0.5Sec. 2 = 1Sec. 3 = 1.5Sec. 4 = 2Sec. 5 = 2.5Sec. 6 = 3Sec. 7 = 3.5Sec. 8 = 4Sec. 9 = 4.5Sec. 10 = 5Sec. 11 = Hold
I33audMeterOverLevel	I33audMeterTBL.6	DisplayString	R/W	-40.0 to 0.0
I33audMeterWarningLevel	I33audMeterTBL.7	DisplayString	R/W	-40.0 to 0.0
I33audMeterRefLevel	I33audMeterTBL.8	DisplayString	R/W	-40.0 to 0.0
I33audLissajouTBL	I33audioTBL.4	Aggregate	-	-
I33audLissajouIntenTBL	I33audLissajouTBL.1	Aggregate	-	-
I33audLissajouIntenLissajou	I33audLissajouIntenTBL.1	INTEGER	R/W	-8 to 7
I33audLissajouIntenScale	I33audLissajouIntenTBL.2	INTEGER	R/W	-8 to 7
I33audLissajouDisplay	I33audLissajouTBL.2	INTEGER	R/W	1 = Multi 2 = Single
I33audLissajouForm	I33audLissajouTBL.3	INTEGER	R/W	1 = X-Y 2 = Matrix
I33audLissajouAutoGain	I33audLissajouTBL.4	INTEGER	R/W	1 = On 2 = Off
I33audLissajouMapTBL	I33audLissajouTBL.5	Aggregate	-	-
I33audlissajouMapSingleL	I33audLissajouMapTBL.1	INTEGER	R/W	1 = Ch1 (omitted) 16 = Ch16 17 = Lt
I33audlissajouMapSingleR	I33audLissajouMapTBL.2	INTEGER	R/W	1 = Ch1 (omitted) 16 = Ch16 17 = Rt
I33audlissajouMapMultiL1	I33audLissajouMapTBL.3	INTEGER	R/W	1 = Ch1 (omitted) 16 = Ch16
I33audlissajouMapMultiR1	I33audLissajouMapTBL.4	INTEGER	R/W	1 = Ch1 (omitted) 16 = Ch16
I33audlissajouMapMultiL2	I33audLissajouMapTBL.5	INTEGER	R/W	1 = Ch1 (omitted) 16 = Ch16
I33audlissajouMapMultiR2	I33audLissajouMapTBL.6	INTEGER	R/W	1 = Ch1

11. ETHERNET REMOTE CONTROL

MIB	OID	SYNTAX	ACCESS	VALUE/RANGE
				(omitted) 16 = Ch16
I33audlissajouMapMultiL3	I33audLissajouMapTBL.7	INTEGER	R/W	1 = Ch1 (omitted) 16 = Ch16
I33audlissajouMapMultiR3	I33audLissajouMapTBL.8	INTEGER	R/W	1 = Ch1 (omitted) 16 = Ch16
I33audlissajouMapMultiL4	I33audLissajouMapTBL.9	INTEGER	R/W	1 = Ch1 (omitted) 16 = Ch16
I33audlissajouMapMultiR4	I33audLissajouMapTBL.10	INTEGER	R/W	1 = Ch1 (omitted) 16 = Ch16
I33audlissajouMapSingle16L	I33audLissajouMapTBL.11	INTEGER	R/W	1 = Ch1 (omitted) 16 = Ch16 17 = Lt
I33audlissajouMapSingle16R	I33audLissajouMapTBL.12	INTEGER	R/W	1 = Ch1 (omitted) 16 = Ch16 17 = Rt
I33audlissajouMapSingleMix16L	I33audLissajouMapTBL.13	INTEGER	R/W	1 = Ch1 (omitted) 8 = Ch8 17 = Lt 18 = D1 (omitted) 25 = D8
I33audlissajouMapSingleMix16R	I33audLissajouMapTBL.14	INTEGER	R/W	1 = Ch1 (omitted) 8 = Ch8 17 = Rt 18 = D1 (omitted) 25 = D8
I33audlissajouMapMulti16L1	I33audLissajouMapTBL.15	INTEGER	R/W	1 = Ch1 (omitted) 16 = Ch16
I33audlissajouMapMulti16R1	I33audLissajouMapTBL.16	INTEGER	R/W	1 = Ch1 (omitted) 16 = Ch16
I33audlissajouMapMulti16L2	I33audLissajouMapTBL.17	INTEGER	R/W	1 = Ch1 (omitted) 16 = Ch16
I33audlissajouMapMulti16R2	I33audLissajouMapTBL.18	INTEGER	R/W	1 = Ch1

## 11. ETHERNET REMOTE CONTROL

MIB	OID	SYNTAX	ACCESS	VALUE/RANGE
				(omitted) 16 = Ch16
I33audlissajouMapMulti16L3	I33audLissajouMapTBL.19	INTEGER	R/W	1 = Ch1 (omitted) 16 = Ch16
I33audlissajouMapMulti16R3	I33audLissajouMapTBL.20	INTEGER	R/W	1 = Ch1 (omitted) 16 = Ch16
I33audlissajouMapMulti16L4	I33audLissajouMapTBL.21	INTEGER	R/W	1 = Ch1 (omitted) 16 = Ch16
I33audlissajouMapMulti16R4	I33audLissajouMapTBL.22	INTEGER	R/W	1 = Ch1 (omitted) 16 = Ch16
I33audlissajouMapMulti16L5	I33audLissajouMapTBL.23	INTEGER	R/W	1 = Ch1 (omitted) 16 = Ch16
I33audlissajouMapMulti16R5	I33audLissajouMapTBL.24	INTEGER	R/W	1 = Ch1 (omitted) 16 = Ch16
I33audlissajouMapMulti16L6	I33audLissajouMapTBL.25	INTEGER	R/W	1 = Ch1 (omitted) 16 = Ch16
I33audlissajouMapMulti16R6	I33audLissajouMapTBL.26	INTEGER	R/W	1 = Ch1 (omitted) 16 = Ch16
I33audlissajouMapMulti16L7	I33audLissajouMapTBL.27	INTEGER	R/W	1 = Ch1 (omitted) 16 = Ch16
I33audlissajouMapMulti16R7	I33audLissajouMapTBL.28	INTEGER	R/W	1 = Ch1 (omitted) 16 = Ch16
I33audlissajouMapMulti16L8	I33audLissajouMapTBL.29	INTEGER	R/W	1 = Ch1 (omitted) 16 = Ch16
I33audlissajouMapMulti16R8	I33audLissajouMapTBL.30	INTEGER	R/W	1 = Ch1 (omitted) 16 = Ch16
I33audlissajouMapMultiD_MixL5	I33audLissajouMapTBL.31	INTEGER	R/W	1 = D1 (omitted) 8 = D8
I33audlissajouMapMultiD_MixR5	I33audLissajouMapTBL.32	INTEGER	R/W	1 = D1 (omitted) 8 = D8
I33audlissajouMapMultiD_MixL6	I33audLissajouMapTBL.33	INTEGER	R/W	1 = D1 (omitted)

## 11. ETHERNET REMOTE CONTROL

MIB	OID	SYNTAX	ACCESS	VALUE/RANGE
				8 = D8
I33audLissajouMapMultiD_MixR6	I33audLissajouMapTBL.34	INTEGER	R/W	1 = D1 (omitted) 8 = D8
I33audLissajouMapMultiD_MixL7	I33audLissajouMapTBL.35	INTEGER	R/W	1 = D1 (omitted) 8 = D8
I33audLissajouMapMultiD_MixR7	I33audLissajouMapTBL.36	INTEGER	R/W	1 = D1 (omitted) 8 = D8
I33audLissajouMapMultiD_MixL8	I33audLissajouMapTBL.37	INTEGER	R/W	1 = D1 (omitted) 8 = D8
I33audLissajouMapMultiD_MixR8	I33audLissajouMapTBL.38	INTEGER	R/W	1 = D1 (omitted) 8 = D8
I33audSurroundTBL	I33audioTBL.5	Aggregate	-	-
I33audSurroundIntenTBL	I33audSurroundTBL.1	Aggregate	-	-
I33audSurroundIntenSurround	I33audSurroundIntenTBL.1	INTEGER	R/W	-8 to 7
I33audSurroundIntenScale	I33audSurroundIntenTBL.2	INTEGER	R/W	-8 to 7
I33audSurround5_1	I33audSurroundTBL.2	INTEGER	R/W	1 = Normal 2 = Phantom
I33audSurroundAutoGain	I33audSurroundTBL.3	INTEGER	R/W	1 = On 2 = Off
I33audSurroundMapTBL	I33audSurroundTBL.4	Aggregate	-	-
I33audSurroundMapL	I33audSurroundMapTBL.1	INTEGER	R/W	1 = Ch1 (omitted) 16 = Ch16
I33audSurroundMapR	I33audSurroundMapTBL.2	INTEGER	R/W	1 = Ch1 (omitted) 16 = Ch16
I33audSurroundMapC	I33audSurroundMapTBL.3	INTEGER	R/W	1 = Ch1 (omitted) 16 = Ch16
I33audSurroundMapLfe	I33audSurroundMapTBL.4	INTEGER	R/W	1 = Ch1 (omitted) 16 = Ch16
I33audSurroundMapLs	I33audSurroundMapTBL.5	INTEGER	R/W	1 = Ch1 (omitted) 16 = Ch16
I33audSurroundMapRs	I33audSurroundMapTBL.6	INTEGER	R/W	1 = Ch1 (omitted) 16 = Ch16
I33audSurroundMapLI	I33audSurroundMapTBL.7	INTEGER	R/W	1 = Ch1 (omitted) 16 = Ch16

11. ETHERNET REMOTE CONTROL

MIB	OID	SYNTAX	ACCESS	VALUE/RANGE
I33audSurroundMapRr	I33audSurroundMapTBL.8	INTEGER	R/W	1 = Ch1 (omitted) 16 = Ch16
I33audStatusTBL	I33audioTBL.6	Aggregate	-	-
I33audStatusLog	I33audStatusTBL.1	INTEGER	R/WO	1 = Log Display
I33audStatusLogLog	I33audStatusTBL.2	INTEGER	R/W	1 = Start 2 = Stop
I33audStatusLogClear	I33audStatusTBL.3	INTEGER	R/WO	1 = Clear
I33audStatusLogLogMode	I33audStatusTBL.4	INTEGER	R/W	1 = Over Write 2 = Stop
I33audStatusDisplayChStatus	I33audStatusTBL.5	INTEGER	R/WO	1 = Ch Status Display
I33audStatusChStatus	I33audStatusTBL.6	INTEGER	R/W	1 = Ch1 / A1 2 = Ch2 / A2 3 = Ch3 / A3 4 = Ch4 / A4 5 = Ch5 / A5 6 = Ch6 / A6 7 = Ch7 / A7 8 = Ch8 / A8 9 = Ch9 / A9 10 = Ch10 / A10 11 = Ch11 / A11 12 = Ch12 / A12 13 = Ch13 / A13 14 = Ch14 / A14 15 = Ch15 / A15 16 = Ch16 / A16 17 = B1 18 = B2 19 = B3 20 = B4 21 = B5 22 = B6 23 = B7 24 = B8 25 = B9 26 = B10 27 = B11 28 = B12 29 = B13 30 = B14 31 = B15 32 = B16
I33audStatusChStatusAlign	I33audStatusTBL.7	INTEGER	R/W	1 = LSB 1st 2 = MSB 1st

11. ETHERNET REMOTE CONTROL

MIB	OID	SYNTAX	ACCESS	VALUE/RANGE
I33audStatusDisplayUserBit	I33audStatusTBL.8	INTEGER	R/WO	1 = User Bit Display
I33audStatusUserBit	I33audStatusTBL.9	INTEGER	R/W	1 = Ch1 / A1 2 = Ch2 / A2 3 = Ch3 / A3 4 = Ch4 / A4 5 = Ch5 / A5 6 = Ch6 / A6 7 = Ch7 / A7 8 = Ch8 / A8 9 = Ch9 / A9 10 = Ch10 / A10 11 = Ch11 / A11 12 = Ch12 / A12 13 = Ch13 / A13 14 = Ch14 / A14 15 = Ch15 / A15 16 = Ch16 / A16 17 = B1 18 = B2 19 = B3 20 = B4 21 = B5 22 = B6 23 = B7 24 = B8 25 = B9 26 = B10 27 = B11 28 = B12 29 = B13 30 = B14 31 = B15 32 = B16
I33audStatusUserBitAlign	I33audStatusTBL.10	INTEGER	R/W	1 = LSB 1st 2 = MSB 1st
I33audStatusErrorLevelOver	I33audStatusTBL.11	INTEGER	R/W	1 = On 2 = Off
I33audStatusErrorClip	I33audStatusTBL.12	INTEGER	R/W	1 = On 2 = Off
I33audStatusErrorClipDuration	I33audStatusTBL.13	INTEGER	R/W	1 to 100
I33audStatusErrorMute	I33audStatusTBL.14	INTEGER	R/W	1 = On 2 = Off
I33audStatusErrorMuteDuration	I33audStatusTBL.15	INTEGER	R/W	1 to 5000
I33audStatusErrorParity	I33audStatusTBL.16	INTEGER	R/W	1 = On 2 = Off

11. ETHERNET REMOTE CONTROL

MIB	OID	SYNTAX	ACCESS	VALUE/RANGE
I33audStatusErrorVaridity	I33audStatusTBL.17	INTEGER	R/W	1 = On 2 = Off
I33audStatusErrorCrc	I33audStatusTBL.18	INTEGER	R/W	1 = On 2 = Off
I33audStatusErrorCode	I33audStatusTBL.19	INTEGER	R/W	1 = On 2 = Off
I33audStatusErrorReset	I33audStatusTBL.20	INTEGER	R/WO	1 = Error Reset
I33audStatusLevelCh1Data	I33audStatusTBL.21	DisplayString	R/O	Ch1 Level
I33audStatusLevelCh2Data	I33audStatusTBL.22	DisplayString	R/O	Ch2 Level
I33audStatusLevelCh3Data	I33audStatusTBL.23	DisplayString	R/O	Ch3 Level
I33audStatusLevelCh4Data	I33audStatusTBL.24	DisplayString	R/O	Ch4 Level
I33audStatusLevelCh5Data	I33audStatusTBL.25	DisplayString	R/O	Ch5 Level
I33audStatusLevelCh6Data	I33audStatusTBL.26	DisplayString	R/O	Ch6 Level
I33audStatusLevelCh7Data	I33audStatusTBL.27	DisplayString	R/O	Ch7 Level
I33audStatusLevelCh8Data	I33audStatusTBL.28	DisplayString	R/O	Ch8 Level
I33audStatusLevelCh9Data	I33audStatusTBL.29	DisplayString	R/O	Ch9 Level
I33audStatusLevelCh10Data	I33audStatusTBL.30	DisplayString	R/O	Ch10 Level
I33audStatusLevelCh11Data	I33audStatusTBL.31	DisplayString	R/O	Ch11 Level
I33audStatusLevelCh12Data	I33audStatusTBL.32	DisplayString	R/O	Ch12 Level
I33audStatusLevelCh13Data	I33audStatusTBL.33	DisplayString	R/O	Ch13 Level
I33audStatusLevelCh14Data	I33audStatusTBL.34	DisplayString	R/O	Ch14 Level
I33audStatusLevelCh15Data	I33audStatusTBL.35	DisplayString	R/O	Ch15 Level
I33audStatusLevelCh16Data	I33audStatusTBL.36	DisplayString	R/O	Ch16 Level
I33audStatusDolbyLocationHData	I33audStatusTBL.37	DisplayString	R/O	EMB Frame Location H
I33audStatusDolbyLocationVData	I33audStatusTBL.38	DisplayString	R/O	EMB Frame Location V
I33audStatusDolbyLocationModeData	I33audStatusTBL.39	DisplayString	R/O	EMB Mode
I33audStatusDolbyLocationEData	I33audStatusTBL.40	DisplayString	R/O	AES Frame Location V
I33audLoudnessTBL	I33audioTBL.7	Aggregate	-	-
I33audLoudPeriod	I33audLoudnessTBL.1	INTEGER	R/W	1 = 2Min. 2 = 10Min. 3 = 30Min. 4 = 1Hour 5 = 2Hour 6 = 6Hour 7 = 12Hour 8 = 24Hour 9 = 32Hour
I33audLoudChartClear	I33audLoudnessTBL.2	INTEGER	R/WO	1 = Clear
I33audLoudMeasure	I33audLoudnessTBL.3	INTEGER	R/W	1 = Start 2 = Stop
I33audLoudMag	I33audLoudnessTBL.4	INTEGER	R/W	1 = Off 2 = On

## 11. ETHERNET REMOTE CONTROL

MIB	OID	SYNTAX	ACCESS	VALUE/RANGE
I33audLoudIntegMode	I33audLoudnessTBL.5	INTEGER	R/W	1 = BS1770-2 2 = ARIB 3 = EBU 4 = ATSC
I33audLoudIntegLevel	I33audLoudnessTBL.6	DisplayString	R/O	Target Level
I33audLoudIntegBlkSize	I33audLoudnessTBL.7	DisplayString	R/O	Block Size
I33audLoudIntegAbsGate	I33audLoudnessTBL.8	DisplayString	R/O	Absolute Gating
I33audLoudIntegOvlpSize	I33audLoudnessTBL.9	DisplayString	R/O	Overlap Size
I33audLoudIntegRelGate	I33audLoudnessTBL.10	DisplayString	R/O	Relative Gating
I33audLoudIntegLfeGain	I33audLoudnessTBL.11	INTEGER	R/W	1 = On 2 = Off
I33audLoudIntegLfeGainValue	I33audLoudnessTBL.12	INTEGER	R/W	0 to 10
I33audLoudShortAvrgTime	I33audLoudnessTBL.13	INTEGER	R/W	200 to 10000
I33audLoudMomentAvrgTime	I33audLoudnessTBL.14	INTEGER	R/W	200 to 10000
I33audLoudResponse	I33audLoudnessTBL.15	INTEGER	R/W	1 = ShortTerm 2 = Momentary
I33audLoudAutoTrigger	I33audLoudnessTBL.16	INTEGER	R/W	1 = Off 2 = Remote 3 = TimeCode
I33audLoudAutoStartH	I33audLoudnessTBL.17	INTEGER	R/W	0 to 23
I33audLoudAutoStartM	I33audLoudnessTBL.18	INTEGER	R/W	0 to 59
I33audLoudAutoStartS	I33audLoudnessTBL.19	INTEGER	R/W	0 to 59
I33audLoudAutoEndH	I33audLoudnessTBL.20	INTEGER	R/W	0 to 23
I33audLoudAutoEndM	I33audLoudnessTBL.21	INTEGER	R/W	0 to 59
I33audLoudAutoEndS	I33audLoudnessTBL.22	INTEGER	R/W	0 to 59
I33audLoudMapMode	I33audLoudnessTBL.23	INTEGER	R/W	1 = Mono 2 = Stereo 3 = 5.1 4 = Custom
I33audLoudMapMonoLR	I33audLoudnessTBL.24	INTEGER	R/W	1 = Ch1 (omitted) 16 = Ch16
I33audLoudMapStereoL	I33audLoudnessTBL.25	INTEGER	R/W	1 = Ch1 (omitted) 16 = Ch16
I33audLoudMapStereoR	I33audLoudnessTBL.26	INTEGER	R/W	1 = Ch1 (omitted) 16 = Ch16
I33audLoudMap51L	I33audLoudnessTBL.27	INTEGER	R/W	1 = Ch1 (omitted) 16 = Ch16
I33audLoudMap51R	I33audLoudnessTBL.28	INTEGER	R/W	1 = Ch1 (omitted) 16 = Ch16
I33audLoudMap51C	I33audLoudnessTBL.29	INTEGER	R/W	1 = Ch1



## 11. ETHERNET REMOTE CONTROL

MIB	OID	SYNTAX	ACCESS	VALUE/RANGE
				(omitted) 16 = Ch16
I33audLoudMap51LFE	I33audLoudnessTBL.30	INTEGER	R/W	1 = Ch1 (omitted) 16 = Ch16
I33audLoudMap51LS	I33audLoudnessTBL.31	INTEGER	R/W	1 = Ch1 (omitted) 16 = Ch16
I33audLoudMap51RS	I33audLoudnessTBL.32	INTEGER	R/W	1 = Ch1 (omitted) 16 = Ch16
I33audLoudMapCustomL	I33audLoudnessTBL.33	INTEGER	R/W	1 = Ch1 (omitted) 16 = Ch16 17 = NC
I33audLoudMapCustomR	I33audLoudnessTBL.34	INTEGER	R/W	1 = Ch1 (omitted) 16 = Ch16 17 = NC
I33audLoudMapCustomC	I33audLoudnessTBL.35	INTEGER	R/W	1 = Ch1 (omitted) 16 = Ch16 17 = NC
I33audLoudMapCustomLFE	I33audLoudnessTBL.36	INTEGER	R/W	1 = Ch1 (omitted) 16 = Ch16 17 = NC
I33audLoudMapCustomLS	I33audLoudnessTBL.37	INTEGER	R/W	1 = Ch1 (omitted) 16 = Ch16 17 = NC
I33audLoudMapCustomRs	I33audLoudnessTBL.38	INTEGER	R/W	1 = Ch1 (omitted) 16 = Ch16 17 = NC
I33audLoudShorttermDataMain	I33audLoudnessTBL.39	DisplayString	R/O	Shortterm Main
I33audLoudIntegratedDataMain	I33audLoudnessTBL.40	DisplayString	R/O	Integrated Main
I33audLoudMomentaryDataMain	I33audLoudnessTBL.41	DisplayString	R/O	Momentary Main
I33audLoudShorttermDataSub	I33audLoudnessTBL.42	DisplayString	R/O	Shortterm Sub
I33audLoudIntegratedDataSub	I33audLoudnessTBL.43	DisplayString	R/O	Integrated Sub
I33audLoudMomentaryDataSub	I33audLoudnessTBL.44	DisplayString	R/O	Momentary Sub
I33audLoudMapSubMode	I33audLoudnessTBL.45	INTEGER	R/W	1 = Off 2 = Mono 3 = Stereo
I33audLoudMapSubMonoLR	I33audLoudnessTBL.46	INTEGER	R/W	1 = Ch1

11. ETHERNET REMOTE CONTROL

MIB	OID	SYNTAX	ACCESS	VALUE/RANGE
				(omitted) 16 = Ch16
I33audLoudMapSubStereoL	I33audLoudnessTBL.47	INTEGER	R/W	1 = Ch1 (omitted) 16 = Ch16
I33audLoudMapSubStereoR	I33audLoudnessTBL.48	INTEGER	R/W	1 = Ch1 (omitted) 16 = Ch16
I33audLoudPeakholdDataL	I33audLoudnessTBL.49	DisplayString	R/O	Ch L Peakhold
I33audLoudPeakholdDataR	I33audLoudnessTBL.50	DisplayString	R/O	Ch R Peakhold
I33audLoudPeakholdDataC	I33audLoudnessTBL.51	DisplayString	R/O	Ch C Peakhold
I33audLoudPeakholdDataLFE	I33audLoudnessTBL.52	DisplayString	R/O	Ch LFE Peakhold
I33audLoudPeakholdDataLS	I33audLoudnessTBL.53	DisplayString	R/O	Ch LS Peakhold
I33audLoudPeakholdDataRS	I33audLoudnessTBL.54	DisplayString	R/O	Ch RS Peakhold
I33audLoudPeakholdDataSL	I33audLoudnessTBL.55	DisplayString	R/O	Ch SUB-L Peakhold
I33audLoudPeakholdDataSR	I33audLoudnessTBL.56	DisplayString	R/O	Ch SUB-R Peakhold
I33audLoudChartSetting	I33audLoudnessTBL.57	INTEGER	R/W	1 = integrated 2 = shortterm 3 = momentary
I33audLoudOverMark	I33audLoudnessTBL.58	INTEGER	R/W	1 = on 2 = off
I33audLoudRelativeGating	I33audLoudnessTBL.59	INTEGER	R/W	1 = on 2 = off
I33audDolbyTBL	I33audioTBL.8	Aggregate	-	-
I33audDolby	I33audDolbyTBL.1	INTEGER	R/W	1 = Off 2 = Dolby-E 3 = Dolby-D
I33audDolbyGroup	I33audDolbyTBL.2	INTEGER	R/W	1 = Ch1-2 2 = Ch3-4 3 = Ch5-6 4 = Ch7-8 5 = Ch9-10 6 = Ch11-12 7 = Ch13-14 8 = Ch15-16
I33audDolbyE_Dialnorm	I33audDolbyTBL.3	INTEGER	R/W	1 = On 2 = Off
I33audDolbyE_Pulldown	I33audDolbyTBL.4	INTEGER	R/W	1 = On 2 = Off
I33audDolbyE_MetaPRM	I33audDolbyTBL.5	INTEGER	R/W	1 = PRM1 2 = PRM2 3 = PRM3

11. ETHERNET REMOTE CONTROL

MIB	OID	SYNTAX	ACCESS	VALUE/RANGE
				4 = PRM4 5 = PRM5 6 = PRM6 7 = PRM7 8 = PRM8
I33audDolbyEBI_MetaPRM	I33audDolbyTBL.6	INTEGER	R/W	1 = PRM1 2 = PRM2 3 = PRM3 4 = PRM4 5 = PRM5 6 = PRM6 7 = PRM7 8 = PRM8
I33audDolbyD_Listening	I33audDolbyTBL.7	INTEGER	R/W	1 = Full 2 = EX 3 = 3Stereo 4 = Phantom 5 = Stereo 6 = Mono
I33audDolbyD_Prologic	I33audDolbyTBL.8	INTEGER	R/W	1 = On 2 = Off
I33audDolbyD_DRC	I33audDolbyTBL.9	INTEGER	R/W	1 = Bypass 2 = Line 3 = Rf
I33audPhonesTBL	I33audioTBL.9	Aggregate	-	-
I33audioPhonesVolume	I33audPhonesTBL.1	INTEGER	R/W	0 to 63
I33audPhonesL	I33audPhonesTBL.2	INTEGER	R/W	1 = Ch1 / A1 2 = Ch2 / A2 3 = Ch3 / A3 4 = Ch4 / A4 5 = Ch5 / A5 6 = Ch6 / A6 7 = Ch7 / A7 8 = Ch8 / A8 9 = Ch9 / A9 / DAUX 10 = Ch10 / A10 11 = Ch11 / A11 12 = Ch12 / A12 13 = Ch13 / A13 14 = Ch14 / A14 15 = Ch15 / A15 16 = Ch16 / A16 17 = Lt / B1 18 = B2 19 = B3

11. ETHERNET REMOTE CONTROL

MIB	OID	SYNTAX	ACCESS	VALUE/RANGE
				20 = B4 21 = B5 22 = B6 23 = B7 24 = B8 25 = B9 26 = B10 27 = B11 28 = B12 29 = B13 30 = B14 31 = B15 32 = B16
I33audPhonesR	I33audPhonesTBL.3	INTEGER	R/W	1 = Ch1 / A1 2 = Ch2 / A2 3 = Ch3 / A3 4 = Ch4 / A4 5 = Ch5 / A5 6 = Ch6 / A6 7 = Ch7 / A7 8 = Ch8 / A8 9 = Ch9 / A9 / DAUX 10 = Ch10 / A10 11 = Ch11 / A11 12 = Ch12 / A12 13 = Ch13 / A13 14 = Ch14 / A14 15 = Ch15 / A15 16 = Ch16 / A16 17 = Lt / B1 18 = B2 19 = B3 20 = B4 21 = B5 22 = B6 23 = B7 24 = B8 25 = B9 26 = B10 27 = B11 28 = B12 29 = B13 30 = B14 31 = B15 32 = B16

11. ETHERNET REMOTE CONTROL

MIB	OID	SYNTAX	ACCESS	VALUE/RANGE
I33audPhonesDolbyDauxCh	I33audPhonesTBL.4	INTEGER	R/W	1 = Ltrt 2 = LoRo 3 = Mono 4 = Mute
I33audPhonesDolbyDauxDRC	I33audPhonesTBL.5	INTEGER	R/W	1 = Line 2 = Rf
I33audSelectTBL	I33audioTBL.10	Aggregate	-	-
I33audNumber	I33audSelectTBL.1	INTEGER	R/W	1 = number8ch 2 = number16ch
I33audDolbyMix	I33audSelectTBL.2	INTEGER	R/W	1 = Off 2 = On

Table 11-23 I33trapTBL(9) group

MIB	OID	SYNTAX	ACCESS	VALUE/RANGE
I33trapStrTBL	I33trapTBL.1	Aggregate	-	- (Variable Binding List)
I33trapIpTBL	I33trapTBL.2	Aggregate	-	-
I33trapIp1TBL	I33trapipTBL.1	Aggregate	-	-
I33trapManagerIp1	I33trapIp1TBL.1	IpAddress	R/W	Trap transmission destination Manager IP address 1
I33trapManagerIp1Act	I33trapIp1TBL.2	INTEGER	R/W	1 = Enable 2 = Disable
I33trapIp2TBL	I33trapipTBL.2	Aggregate	-	-
I33trapManagerIp2	I33trapIp2TBL.1	IpAddress	R/W	Trap transmission destination Manager IP address 2
I33trapManagerIp2Act	I33trapIp2TBL.2	INTEGER	R/W	1 = Enable 2 = Disable
I33trapIp3TBL	I33trapipTBL.3	Aggregate	-	-
I33trapManagerIp3	I33trapIp3TBL.1	IpAddress	R/W	Trap transmission destination Manager IP address 3
I33trapManagerIp3Act	I33trapIp3TBL.2	INTEGER	R/W	1 = Enable 2 = Disable
I33trapIp4TBL	I33trapipTBL.4	Aggregate	-	-
I33trapManagerIp4	I33trapIp4TBL.1	IpAddress	R/W	Trap transmission destination Manager IP address 4
I33trapManagerIp4Act	I33trapIp4TBL.2	INTEGER	R/W	1 = Enable 2 = Disable

## 11.3.5 Extended TRAP (Variable Binding List)

- **index 1**

OID: [LV 5770A]  
 leader(20111).lv5770a(33).lv5770aST1(1).trapTBL(9).trapStrTBL(1).1.0  
 [LV 5770]  
 leader(20111).lv5770(21).lv5770ST1(1).trapTBL(9).trapStrTBL(1).1.0

Syntax: Counter  
 Range: 1 to 4294967295 (overflow occurs if this range is exceeded)  
 Description: The total number of enterprise traps sent after starting up

- **index 2**

OID: [LV 5770A]  
 leader(20111).lv5770a(33).lv5770aST1(1).trapTBL(9).trapStrTBL(1).2.0  
 [LV 5770]  
 leader(20111).lv5770(21).lv5770ST1(1).trapTBL(9).trapStrTBL(1).2.0

Syntax: DisplayString  
 Range: Up to 40 characters  
 Description: Date and time of error occurrence and line information  
 YYYY/MM/DD hh:mm:ss input channel (A/B/-)  
 Example: 2007/07/02 11:30:11 A

- **index 3**

OID: [LV 5770A]  
 leader(20111).lv5770a(33).lv5770aST1(1).trapTBL(9).trapStrTBL(1).3.0  
 [LV 5770]  
 leader(20111).lv5770(21).lv5770ST1(1).trapTBL(9).trapStrTBL(1).3.0

Syntax: DisplayString  
 Range: Up to 40 characters  
 Description: Format information  
 Example: 1080sF/30

- **index 4**

OID: [LV 5770A]  
 leader(20111).lv5770a(33).lv5770aST1(1).trapTBL(9).trapStrTBL(1).4.0  
 [LV 5770]  
 leader(20111).lv5770(21).lv5770ST1(1).trapTBL(9).trapStrTBL(1).4.0

Syntax: DisplayString  
 Range: Up to 40 characters  
 Description: Error information (see the table below)  
 Example: TRS\_P\_ERR

11. ETHERNET REMOTE CONTROL

Table 11-24 Error information

Specific Trap Type	Indication	Description
1	FAN_STOP	Fan stop detection
3	None (displayed in format information)	No signal
6	LINE_ERR	Line number error detection
7	CRC_ERR	CRC error detection
9	CHK_ERR	Checksum error detection
10	A_BCH_ERR	(EMB AUDIO) BCH error detection
11	EDH_ERR	EDH error detection
12	ILLEGAL_ERR	Illegal command error detection
13	PRTY_ERR	Parity error detection
15	TRS_P_ERR	TRS Pos error detection
16	TRS_C_ERR	TRS Code error detection
17	FRZ_ERR	Freeze error detection
18	BLK_ERR	Black error detection
21	SDI_DELAY_ERR	SDI delay error detection
23	GMUT_ERR	Gamut error detection
24	CGMUT_ERR	Composite gamut error detection
25	LVL_Y_ERR	Luminance level error detection
26	LVL_C_ERR	Chroma level error detection
27	None (displayed in format information)	Unsupported input signal format or an input signal format that is different from the specified format
37	None (displayed in format information)	No error (at error recovery, at startup)
40	A_PRTY_ERR	(EMB AUDIO) PARITY error detection
41	A_DBN_ERR	(EMB AUDIO) DBN error detection
42	A_INH_ERR	(EMB AUDIO) INH error detection
43	A_SMP_ERR	(EMB AUDIO) SAMPLE error detection
44	CABLE_ERR / CABLE_WAR	Cable error or cable warning detection
66	EYE_SD_AMP_ERR	(EYE) SD amplitude error detection
67	EYE_SD_TR_ERR	(EYE) SD Rise Time error detection
68	EYE_SD_TF_ERR	(EYE) SD Fall Time error detection
69	EYE_SD_TR_TF_ERR	(EYE) SD Delta Time error detection
70	EYE_SD_T_JIT_ERR	(EYE) SD Timing jitter error detection
71	EYE_SD_A_JIT_ERR	(EYE) SD Current jitter error detection
81	EYE_SD_OR_ERR	(EYE) SD Overshoot Rising error detection
82	EYE_SD_OF_ERR	(EYE) SD Overshoot Falling error detection
60	EYE_HD_AMP_ERR	(EYE) HD amplitude error detection
61	EYE_HD_TR_ERR	(EYE) HD Rise Time error detection
62	EYE_HD_TF_ERR	(EYE) HD Fall Time error detection
63	EYE_HD_TR_TF_ERR	(EYE) HD Delta Time error detection
64	EYE_HD_T_JIT_ERR	(EYE) HD Timing jitter error detection
65	EYE_HD_A_JIT_ERR	(EYE) HD Current jitter error detection
83	EYE_HD_OR_ERR	(EYE) HD Overshoot Rising error detection
84	EYE_HD_OF_ERR	(EYE) HD Overshoot Falling error detection
85	EYE_3G_AMP_ERR	(EYE) 3G amplitude error detection
86	EYE_3G_TR_ERR	(EYE) 3G Rise Time error detection

## 11. ETHERNET REMOTE CONTROL

Specific Trap Type	Indication	Description
87	EYE_3G_TF_ERR	(EYE) 3G Fall Time error detection
88	EYE_3G_TR_TF_ERR	(EYE) 3G Delta Time error detection
89	EYE_3G_T_JIT_ERR	(EYE) 3G Timing jitter error detection
90	EYE_3G_A_JIT_ERR	(EYE) 3G Current jitter error detection
91	EYE_3G_OR_ERR	(EYE) 3G Overshoot Rising error detection
92	EYE_3G_OF_ERR	(EYE) 3G Overshoot Falling error detection
93	EYE_DCOFSET_ERR	(EYE) DC offset error detection
100	AUD_OVER_ERR	(AUDIO) LEVEL error detection
101	AUD_CLIP_ERR	(AUDIO) CLIP error detection
102	AUD_MUTE_ERR	(AUDIO) MUTE error detection
103	AUD_PAR_ERR	(AUDIO) PARITY error detection
104	AUD_VAL_ERR	(AUDIO) VALIDITY error detection
105	AUD_CRC_ERR	(AUDIO) CRC error detection
106	AUD_CODE_ERR	(AUDIO) CODE VIOLATION error detection



## 11.4 HTTP Server Feature

You can use this feature to control the LV 5770A from a web browser on a PC in the same manner as you would control the LV 5770A from the panel.

### 11.4.1 Operating Environment

The following web browsers have been confirmed to work.

- Internet Explorer Ver.8.0
- Mozilla Firefox Ver.7.0.1

### 11.4.2 Precautions

- After you press a key in the web browser interface, wait for the screen to update before you perform the next operation. The screen cannot redraw fast enough to keep up with consecutive key presses. In this situation, a completely gray screen may be displayed temporarily. (After a few seconds the screen will return to normal.)
- When you are using the HTTP server feature, perform as few panel operations on the LV 5770A as possible. The LV 5770A's internal processing load increases when it is redrawing the web browser screen, so there is a lag of 1 to 2 seconds from the time that you perform panel operations on the LV 5770A to the time that the operations are actually carried out.
- The HTTP server feature only supports a single connection to a PC at any one time. Multiple simultaneous connections are not supported.

### 11.4.3 Procedure

#### 1. Configure the Ethernet settings on the LV 5770A's ETHERNET SETUP tab.

Set the IP Address, and set HTTP Server Select to ON.

See section 7.2.2, "Configuring Ethernet Settings."

**SYS** → **F•2** SYSTEM SETUP → **F•3** NEXT TAB →

GENERAL SETUP	ETHERNET SETUP	REMOTE SETUP	DATE&TIME
Ethernet Select	<input type="checkbox"/> DHCP	<input checked="" type="checkbox"/> IP	
TCP / IP			
IP Address	<input type="text" value="192"/>	<input type="text" value="168"/>	<input type="text" value="0"/> <input type="text" value="1"/>
Subnet Mask	<input type="text" value="255"/>	<input type="text" value="255"/>	<input type="text" value="255"/> <input type="text" value="0"/>
Default Gateway	<input type="text" value="0"/>	<input type="text" value="0"/>	<input type="text" value="0"/> <input type="text" value="0"/>
SNTP Client Select	<input checked="" type="checkbox"/> OFF	<input type="checkbox"/> ON	
Server IP Address	<input type="text" value="0"/>	<input type="text" value="0"/>	<input type="text" value="0"/> <input type="text" value="0"/>
Time Zone Adjust	<input type="text" value="+"/>	<input type="text" value="9"/>	: <input type="text" value="0"/> [ +/- hour : minutes ]
TELNET Server Select	<input checked="" type="checkbox"/> OFF	<input type="checkbox"/> ON	<input type="checkbox"/> LV7770-01
FTP Server Select	<input checked="" type="checkbox"/> OFF	<input type="checkbox"/> ON	
HTTP Server Select	<input type="checkbox"/> OFF	<input checked="" type="checkbox"/> ON	
SNMP READ	<input checked="" type="checkbox"/> OFF	<input type="checkbox"/> ONLY	<input type="checkbox"/> WRITE
SNMP TRAP	<input checked="" type="checkbox"/> OFF	<input type="checkbox"/> ON	
NETWORK MODE	<input type="checkbox"/> LV5770	<input checked="" type="checkbox"/> LV5770A	
			MAC ADDRESS: 00:00:00:00:00:00

Figure 11-4 ETHERNET SETUP tab

**2. Press F•1 COMPLETE.**

The message “Saving data - Please Wait” is displayed.

**3. If you changed the IP address, after the message disappears, restart the LV 5770A.**

The IP address value is now valid.

**4. Connect the LV 5770A's Ethernet port to the network.**

Use a UTP cable (category 5).

**5. Start the web browser on your PC.**

The HTTP server feature uses JavaScript.

Enable JavaScript in your web browser.

**6. In the address box, enter “http://” and the IP address that you set in step 1.**

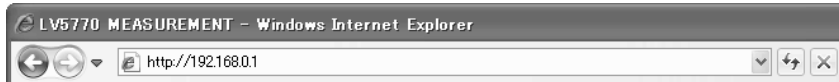

Figure 11-5 IP address input

**7. When the Display Size Select screen appears, select Half or Full.**

The operations differ as shown below according to the display size. Select the display size that meets your needs.

Table 11-25 Selecting the display size

		Half	Full
Display area [pixel]	LCD	512 x 384	1024 x 768
	All	858 x 533	1716 x 1066
Operation response time [sec]		Approx. 2 to 5	Approx. 4 to 10
Automatic display update interval [sec]		5	10
Explanation		The display is half the size as that on the LV 5770A, so some text is difficult to read, but the operation response is fast.	The display is the same size as that on the LV 5770A, but the operation response is slow.



Figure 11-6 Display size selection screen

8. After the main screen is displayed, you can click the keys in the web browser to control the LV 5770A.

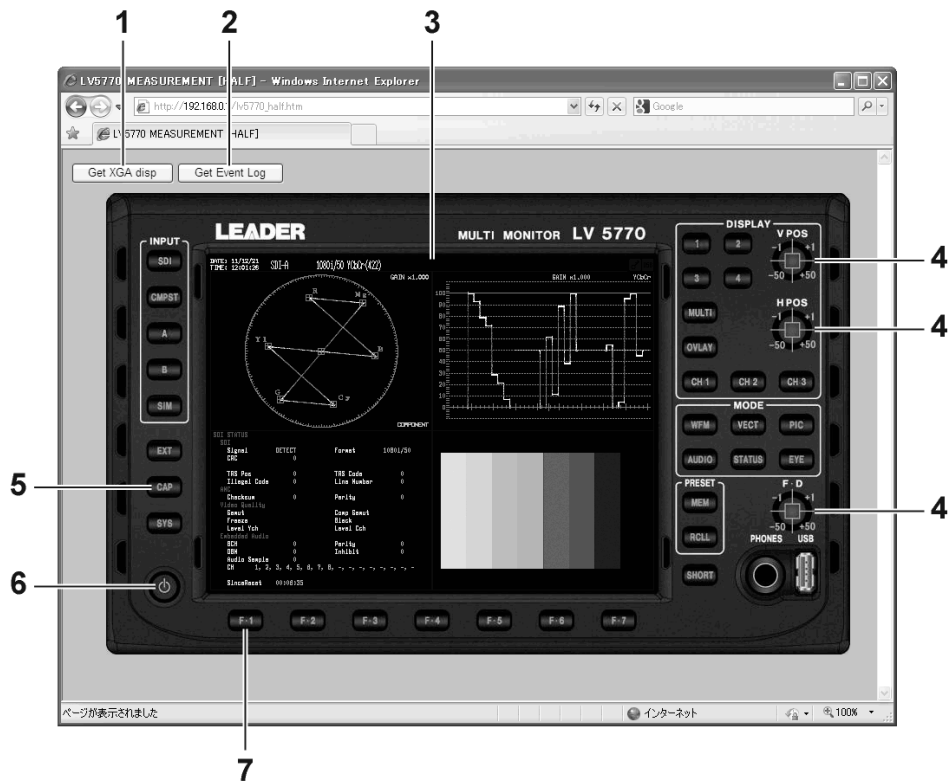

Figure 11-7 Main display

Table 11-26 Main display explanation

Number	Name	Explanation
1	Get XGA disp	Click this to capture the currently displayed screen and display it in a different window. You can use the window's menu to save the screen as a .bmp file.
2	Get Event Log	Click this to display the event log in a different window. You can use the window's menu to save the event log as a .txt file. First, you have to enable the event log feature.
3	Display screen	Click this to update the screen. (The screen updates automatically every 5 seconds for the "Half" screen and every 10 seconds for the "Full" screen even if you do not click the screen.)
4	V POS H POS F·D	-50, -1, +1, and +50 are assigned to the four areas. Click the square in the center of each of these controls to perform the same operation as pressing the corresponding control on the LV 5770A. On tab menus and some screens, -50 operates as -5 and +50 operates as +5. Also, in places where the setting resolution is a value other than 1, the value that is set is "resolution × the setting specified by the knob."
5	CAP	Pressing the CAP key does not capture the screen correctly. Use the "Get XGA disp" button.
6	Power switch	Pressing the power switch has no effect.

## 11. ETHERNET REMOTE CONTROL

Number	Name	Explanation
7	Function keys	<p>When you use the function keys to select settings, pop-ups are displayed in the web browser, so select the option within 2 seconds of the pop-up being displayed.</p> <p>The timing at which the function menus disappear is different between the LV 5770A and the browser, so when you control a function menu in the browser, the corresponding response may not be what you would expect. In this situation, set MENU Auto Off to a long time in the system menu.</p> <p>For information on the MENU Auto Off setting, see section 7.2.1, "General Settings."</p>

## 11.5 SNTP Client Function

The LV 5770A can display time that is synchronized to an NTP server on the network.

### 11.5.1 Procedure

**1. Configure the Ethernet settings on the LV 5770A's ETHERNET SETUP tab.**

Set SNTP Client Select to ON, and set the IP address, server IP address, and time zone adjustment. For details on time zone adjustment, see the next section.

Reference 7.2.2, "Configuring Ethernet Settings"

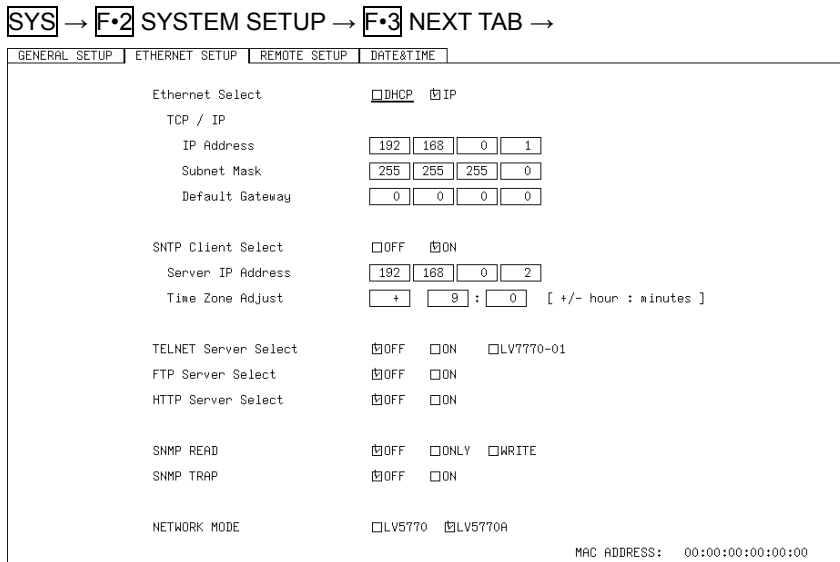

Figure 11-8 ETHERNET SETUP tab

**2. Press F•1 COMPLETE.**

The message "Saving data - Please Wait" is displayed.

**3. If you changed the IP address, after the message disappears, restart the LV 5770A.**

The new IP address will take effect.

**4. Connect the LV 5770A's Ethernet port to the network.**

Use a UTP cable (category 5).

The LV 5770A connects to the NTP server at the following times.

- When you press F•1 COMPLETE in SYSTEM SETUP
- Once every approximately 10 minutes

When the LV 5770A connects normally to an NTP server, the date and time are displayed at the upper left of the screen.

Otherwise, "SNTP:ERR" appears next to DATE, and the time that was set up to that point is displayed next to TIME.

Normal connection  
 DATE: 12/05/11  
 TIME: 09:16:01

Connection error  
 DATE: SNTP:ERR  
 TIME: 09:16:01

## 11.5.2 Time Adjustment Value

The date and time exchanged with an NTP (SNTP) are basically Coordinated Universal Time (UTC). Therefore, the time must be adjusted in accordance with the country or region where the device is used in. On the ETHERNET SETUP tab, set Time Zone Adjust to one of the following values.

Table 11-27 Time adjustment values

Country or region	Time Zone Adjust
Eniwetok, Kwajalein	-12:0
Midway Island, Samoa	-11:0
Hawaii	-10:0
Alaska	-9:0
Pacific Time (US & Canada), Tijuana	-8:0
Mountain Time (US & Canada), Arizona	-7:0
Central Time (US & Canada), Central America, Saskatchewan, Mexico City	-6:0
Eastern Time (US & Canada), Indiana (East), Bogota, Lima, Quito	-5:0
Atlantic Time (Canada), La Paz, Santiago	-4:0
Newfoundland	-3:30
Greenland, Buenos Aires, Georgetown, Brasilia	-3:0
Mid-Atlantic	-2:0
Azores, Cape Verde Is.	-1:0
Greenwich Mean Time (Dublin, Edinburgh, Lisbon, London), Casablanca, Monrovia	-/+0:0
Amsterdam, Berlin, Bern, Rome, Stockholm, Sarajevo, Skopje, Sofija, Vilnius, Warsaw, Zagreb, Brussels, Madrid, Copenhagen, Paris, Belgrade, Bratislava, Budapest, Ljubljana, Prague, West Central Africa	+1:0
Athens, Istanbul, Minsk, Jerusalem, Cairo, Harare, Pretoria, Bucharest, Isinki, Riga, Tallinn	+2:0
Kuwait, Riyadh, Nairobi, Baghdad, Moscow, Volgograd, St. Petersburg	+3:0
Tehran	+3:30
Abu Dhabi, Muscat, Baku, Tbilisi, Yerevan	+4:0
Kabul	+4:30
Islamabad, Karachi, Tashkent, Ekaterinburg	+5:0
Kolkata, Chennai, Mumbai, New Delhi	+5:30
Kathmandu	+5:45
Astana, Dhaka, Almaty, Novosibirsk	+6:0
Rangoon	+6:30
Krasnoyarsk, Bangkok, Hanoi, Jakarta	+7:0
Irkutsk, Ulaan Bataar, Kuala Lumpur, Singapore, Perth, Taipei, Beijing, Chongqing, Hong Kong SAR, Urumqi	+8:0
Seoul, Yakutsk, Osaka, Sapporo, Tokyo	+9:0
Adelaide, Darwin	+9:30
Vladivostok, Canberra, Melbourne, Sydney, Guam, Port Moresby, Brisbane, Hobart	+10:0
Magadan, Solomon Is., New Caledonia	+11:0
Auckland, Wellington, Fiji Islands, Kamchatka, Marshall Is.	+12:0
Nuku'alofa	+13:0

## 12. MENU TREES

This chapter shows the menu trees that correspond to each key.

The default settings are underlined. The settings selected in the tab menu displays are also default settings.

The menus that are displayed vary depending on the LV 5770A settings and whether a USB memory device is connected to the LV 5770A.

### 12.1 System Menu

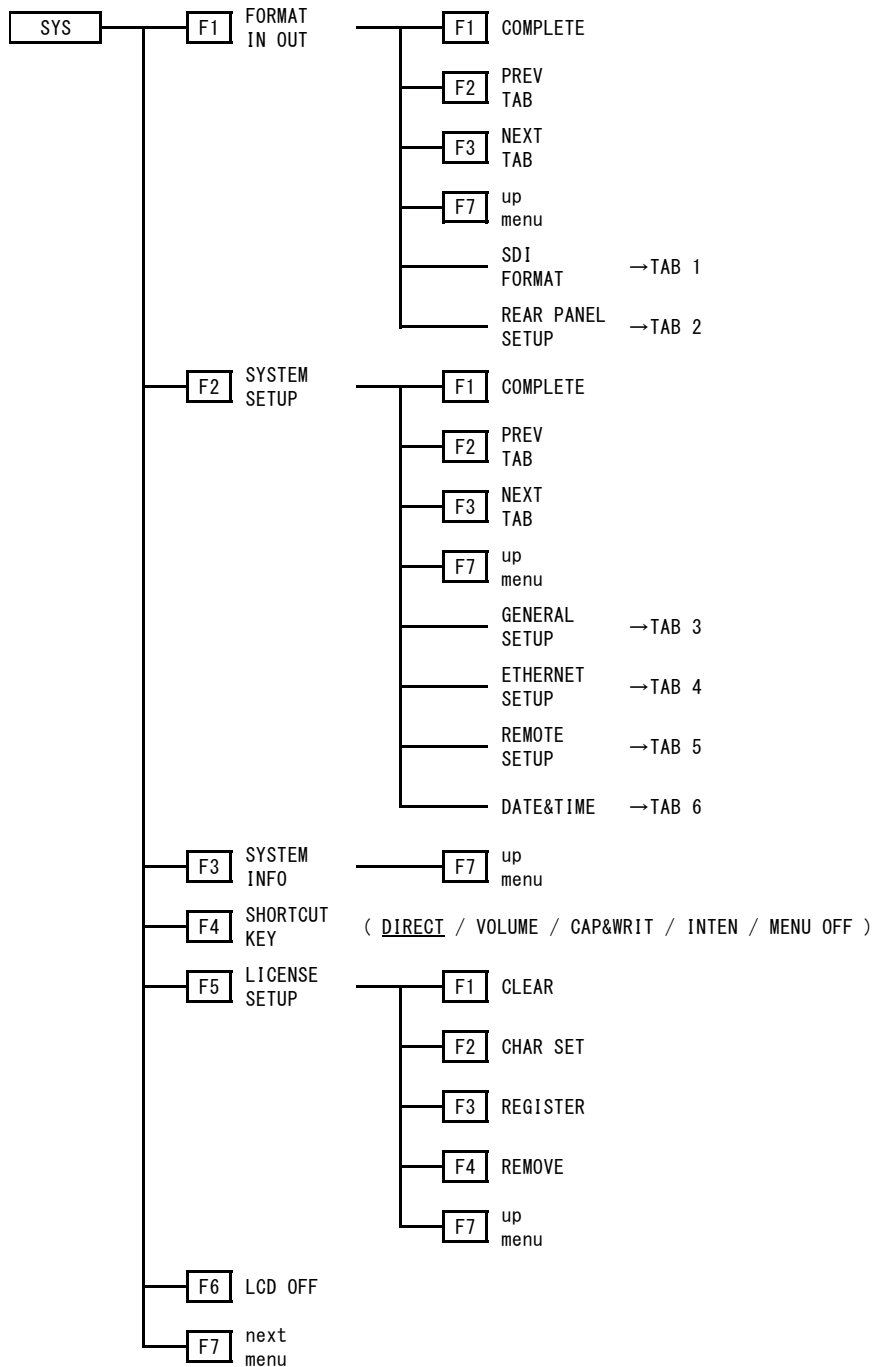

## 12. MENU TREES

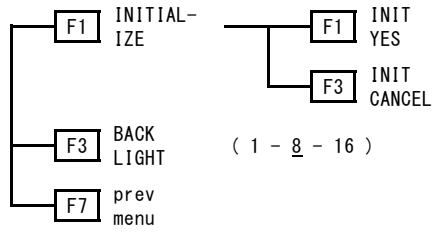

**TAB 1 (SDI FORMAT)**

SDI FORMAT	REAR PANEL SETUP
Auto/Manual	<input checked="" type="checkbox"/> Auto <input type="checkbox"/> Manual
1/PsF Select	<input checked="" type="checkbox"/> Interlace <input type="checkbox"/> Segmented Frame(PsF)
Format	
Link Format	<input checked="" type="checkbox"/> HD <input type="checkbox"/> SD <input type="checkbox"/> HD-DualLink <input type="checkbox"/> 3G-A <input type="checkbox"/> 3G-B <input type="checkbox"/> 3G-B(2map)
Color System	<input checked="" type="checkbox"/> YCbCr(4:2:2) <input type="checkbox"/> YCbCr(4:4:4) <input type="checkbox"/> RGB(4:4:4)
Pixel Depth	<input checked="" type="checkbox"/> 10bit <input type="checkbox"/> 12bit
Scanning	<input checked="" type="checkbox"/> 1080P <input type="checkbox"/> 1080i <input type="checkbox"/> 1080PsF <input type="checkbox"/> 720P <input type="checkbox"/> 525i <input type="checkbox"/> 625i
Active Sample	<input checked="" type="checkbox"/> 1920 <input type="checkbox"/> 2048(2K)
Frame Rate	<input checked="" type="checkbox"/> 60 <input type="checkbox"/> 59.94 <input type="checkbox"/> 50 <input type="checkbox"/> 30 <input type="checkbox"/> 29.97 <input type="checkbox"/> 29.97 <input type="checkbox"/> 25 <input type="checkbox"/> 24 <input type="checkbox"/> 23.98
	EX. 59.94p : F.R.= 59.94 59.94i : F.R.= 29.97

**TAB 2 (REAR PANEL SETUP)**

SDI FORMAT	REAR PANEL SETUP
SDI Select Output	<input checked="" type="checkbox"/> Ach/Bch <input type="checkbox"/> Ach
Audio BNC	
GROUP A	<input checked="" type="checkbox"/> INPUT <input type="checkbox"/> OUTPUT
GROUP B	<input checked="" type="checkbox"/> INPUT <input type="checkbox"/> OUTPUT
GROUP A OUT SEL	<input checked="" type="checkbox"/> Display Source <input type="checkbox"/> SDI 1-8ch
GROUP B OUT SEL	<input checked="" type="checkbox"/> Display Source <input type="checkbox"/> SDI 9-16ch
ANALOG AUDIO	<input checked="" type="checkbox"/> INPUT <input type="checkbox"/> OUTPUT
DVI-D Aspect	<input checked="" type="checkbox"/> 4:3 <input type="checkbox"/> 16:9 <input type="checkbox"/> 16:10
PIC MONI Output	
Color Format	<input type="checkbox"/> Auto <input type="checkbox"/> YCbCr 422 <input type="checkbox"/> YCbCr 444 <input checked="" type="checkbox"/> RGB 444
Pixel Depth	<input type="checkbox"/> Auto <input checked="" type="checkbox"/> 8bit <input type="checkbox"/> 10bit <input type="checkbox"/> 12bit
2MAPPING SDI	<input checked="" type="checkbox"/> STREAM1 <input type="checkbox"/> STREAM2



## 12. MENU TREES

### TAB 3 (GENERAL SETUP)

GENERAL SETUP	ETHERNET SETUP	REMOTE SETUP	DATE&TIME
GENERAL SETUP			
Multi Display	<input type="checkbox"/> 2Multi	<input checked="" type="checkbox"/> 4Multi	
Capture Mode	<input checked="" type="checkbox"/> Screen	<input type="checkbox"/> Video Frame(SDI Only)	
Memory Store Mode	<input type="checkbox"/> Loudness 2h	<input checked="" type="checkbox"/> Loudness 32h (No TIF/DPX Frame Capture)	
Information Display			
Format	<input checked="" type="checkbox"/> ON	<input type="checkbox"/> OFF	
Date	<input type="checkbox"/> OFF	<input checked="" type="checkbox"/> y/m/d	<input type="checkbox"/> m/d/y <input type="checkbox"/> d/m/y
Time	<input type="checkbox"/> OFF	<input checked="" type="checkbox"/> Real Time	<input type="checkbox"/> LTC <input type="checkbox"/> VITC <input type="checkbox"/> D-VITC
Color System	<input checked="" type="checkbox"/> ON	<input type="checkbox"/> OFF	
Input	<input checked="" type="checkbox"/> ON	<input type="checkbox"/> OFF	
LCD Setup			
Auto Off	<input checked="" type="checkbox"/> OFF	<input type="checkbox"/> 5min	<input type="checkbox"/> 30min <input type="checkbox"/> 60min
MENU Setup			
Auto Off	<input type="checkbox"/> OFF	<input checked="" type="checkbox"/> ON	
Time	<input type="text" value="5"/>	sec(1-60)	

### TAB 4 (ETHERNET SETUP)

GENERAL SETUP	ETHERNET SETUP	REMOTE SETUP	DATE&TIME
Ethernet Select	<input type="checkbox"/> DHCP	<input checked="" type="checkbox"/> IP	
TCP / IP			
IP Address	<input type="text" value="192"/>	<input type="text" value="168"/>	<input type="text" value="0"/> <input type="text" value="1"/>
Subnet Mask	<input type="text" value="255"/>	<input type="text" value="255"/>	<input type="text" value="255"/> <input type="text" value="0"/>
Default Gateway	<input type="text" value="0"/>	<input type="text" value="0"/>	<input type="text" value="0"/> <input type="text" value="0"/>
SNTP Client Select			
Server IP Address	<input checked="" type="checkbox"/> OFF	<input type="checkbox"/> ON	
Time Zone Adjust	<input type="text" value="0"/>	<input type="text" value="0"/>	<input type="text" value="0"/> <input type="text" value="0"/>
	<input type="text" value="+"/>	<input type="text" value="9"/>	: <input type="text" value="0"/> [ +/- hour : minutes ]
TELNET Server Select	<input checked="" type="checkbox"/> OFF	<input type="checkbox"/> ON	<input type="checkbox"/> LV7770-01
FTP Server Select	<input checked="" type="checkbox"/> OFF	<input type="checkbox"/> ON	
HTTP Server Select	<input checked="" type="checkbox"/> OFF	<input type="checkbox"/> ON	
SNMP READ	<input checked="" type="checkbox"/> OFF	<input type="checkbox"/> ONLY	<input type="checkbox"/> WRITE
SNMP TRAP	<input checked="" type="checkbox"/> OFF	<input type="checkbox"/> ON	
NETWORK MODE	<input type="checkbox"/> LV5770	<input checked="" type="checkbox"/> LV5770A	
MAC ADDRESS: 00:00:00:00:00:00			

### TAB 5 (REMOTE SETUP)

GENERAL SETUP	ETHERNET SETUP	REMOTE SETUP	DATE&TIME
Remote Setup			
Remote Mode	<input checked="" type="checkbox"/> BIT	<input type="checkbox"/> BINARY	
Remote Select	<input checked="" type="checkbox"/> Recall	<input type="checkbox"/> Recall and Loudness	
Alarm Polarity	<input checked="" type="checkbox"/> POSITIVE	<input type="checkbox"/> NEGATIVE	
Alarm Select	<input checked="" type="checkbox"/> A	<input type="checkbox"/> B <input type="checkbox"/> AB	

## 12. MENU TREES

TAB 6 (DATE&TIME)

GENERAL SETUP	ETHERNET SETUP	REMOTE SETUP	DATE&TIME
DATE ADJUST			
DAY			<input type="text" value="9"/>
MONTH			<input type="text" value="6"/>
YEAR			<input type="text" value="2011"/>
TIME ADJUST			
HOURL			<input type="text" value="9"/>
MINUTE			<input type="text" value="58"/>
SECOND			<input type="text" value="56"/>

### 12.2 Capture Menu

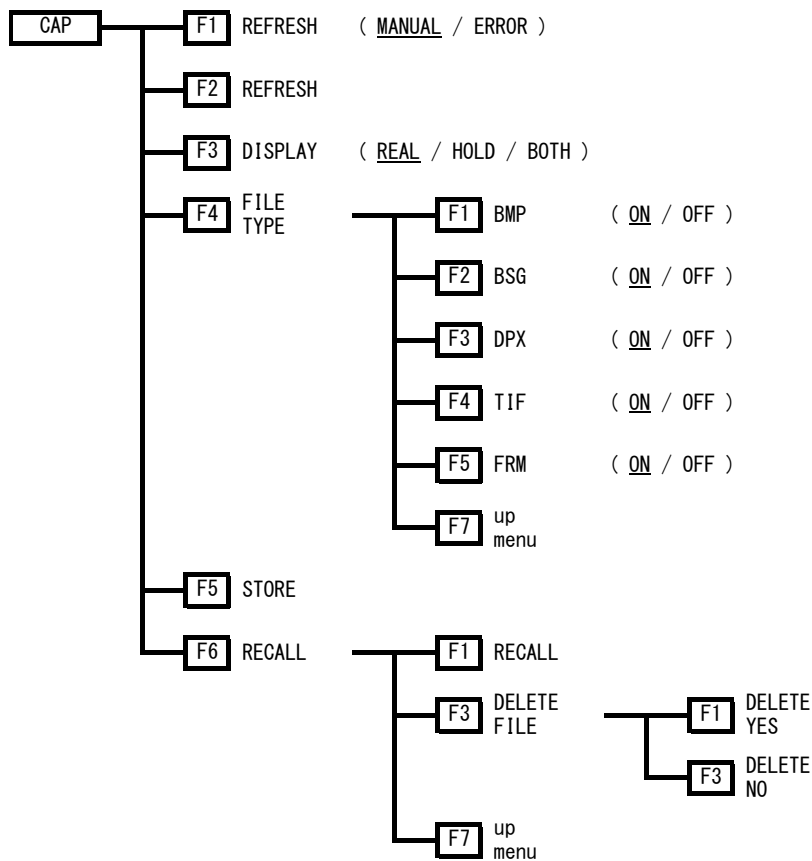

12.3 Preset Registration Menu

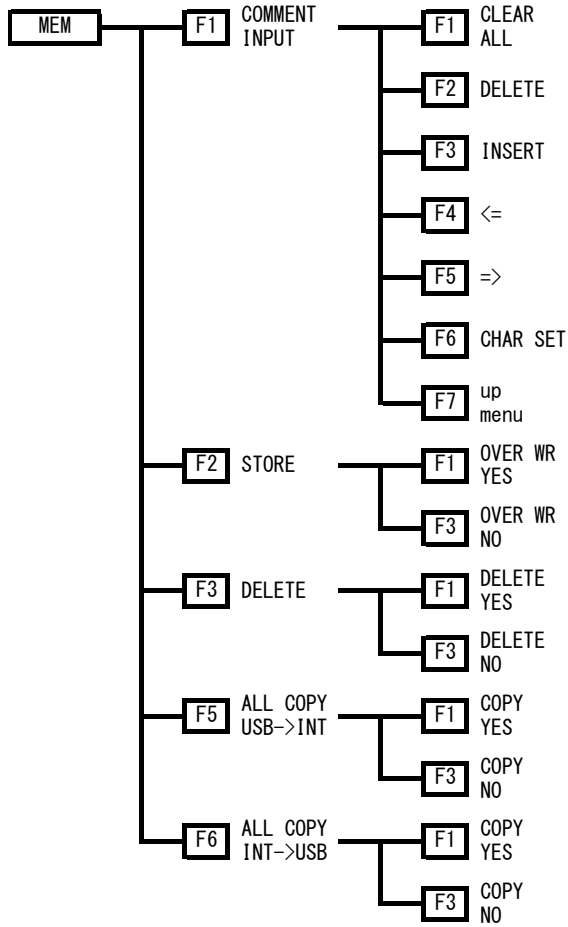

### 12.4 Preset Load Menu

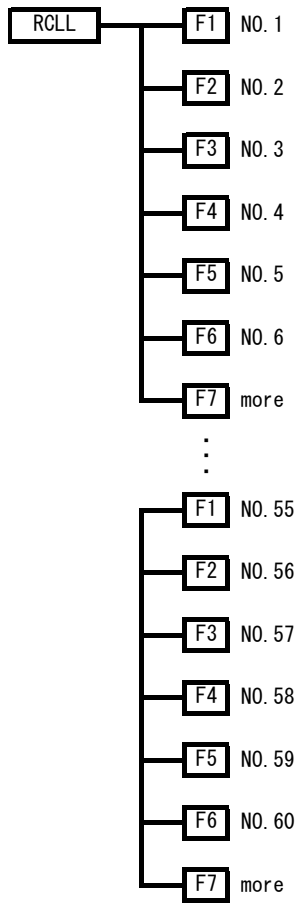

## 13. CHANGE HISTORY OF THE SOFTWARE

This manual was written for firmware version 1.8.

You can view the firmware version by pressing **F•3** SYSTEM INFO on the system menu.

- **Ver. 1.8**

[LV 5770SER08 and LV 5770SER09A] An audio signal gate setting function was added to the lip sync measurement of the status display.

- **Ver. 1.6**

[LV 5770SER08 and LV 5770SER09A] A measurement range setting function was added to the lip sync measurement of the status display.

- **Ver. 1.5**

[LV 5770A] LV 5770 compatible mode was added for TELNET, FTP, and SNMP.

[LV 5770A] Recall menu was improved so that each time the RCLL key is pressed, the menu toggles between show and hide.

- **Ver. 1.2**

[LV 5770SER08 and LV 5770SER09A] 3G-SDI lip sync measurement is now supported.

# INDEX

## A

ALL COPY INT->USB .....	99
ALL COPY USB->INT .....	100
ANALOG AUDIO .....	49

## B

BACK LIGHT .....	84
BMP .....	87
BSG .....	87

## C

CAP .....	85
COMMENT INPUT .....	97
COMPOSITE VIDEO .....	48

## D

DELETE .....	98
DELETE FILE .....	89, 95
DIGITAL AUDIO IN/OUT .....	48
DISPLAY .....	86, 92
DPX .....	92
DVI-D OUTPUT .....	50

## E

ETHERNET .....	106
EXT REF .....	45

## F

FILE TYPE .....	87, 92
FORMAT IN OUT .....	69
FRM .....	92

## I

INITIALIZE .....	83
------------------	----

## L

LCD OFF .....	83
LICENSE SETUP .....	83

## M

MEM .....	96, 98
MULTI .....	57

## P

PIC MONI OUTPUT .....	44
-----------------------	----

## R

RCLL .....	96
RECALL .....	88, 94
REFRESH .....	86, 90
REMOTE .....	101

## S

SDI INPUT .....	42
SDI OUTPUT .....	44
SHORT .....	55
SHORTCUT KEY .....	82
STORE .....	87, 92, 97
SYS .....	68
SYSTEM INFO .....	82
SYSTEM SETUP .....	75

## T

TIF .....	92
TRIGGER .....	90

Following information is for Chinese RoHS only

## 所含有毒有害物质信息

部件号码: LV 5770/5770A/SER03/SER03A/SER08/  
SER09/SER09A/SER41/SER42/SER43



此标志适用于在中国销售的电子信息产品, 依据2006年2月28日公布的《电子信息产品污染控制管理办法》以及SJ/T11364-2006《电子信息产品污染控制标识要求》, 表示该产品在使用完结后可再利用。数字表示的是环境保护使用期限, 只要遵守与本产品有关的安全和使用上的注意事项, 从制造日算起在数字所表示的年限内, 产品不会产生环境污染和对人体、财产的影响。产品适当使用后报废的方法请遵从电子信息产品的回收、再利用相关法令。详细请咨询各级政府主管部门。

产品中有毒有害物质或元素的名称及含量

部件名称 Parts	有毒有害物质或元素 Hazardous Substances in each Part					
	铅 (Pb)	汞 (Hg)	镉 (Cd)	六价铬 (Cr(VI))	多溴联苯 (PBB)	多溴二苯醚 (PBDE)
实装基板	×	○	○	○	○	○
主体部	×	○	○	○	○	○
液晶显示模组	×	×	○	○	○	○
开关电源	×	○	○	○	○	○
风扇	×	○	○	○	○	○
外筐	×	○	○	○	○	○
线材料一套	×	○	○	○	○	○
附件	×	○	○	○	○	○
包装材	○	○	○	○	○	○
电池	○	○	○	○	○	○

**备注)**

- : 表示该有毒有害物质在该部件所有均质材料中的含量均在SJ/T11363-2006 规定的限量要求以下。
- ×: 表示该有毒有害物质或元素至少在该部件的某一均质材料中的含量超出SJ/T11363-2006 标准规定的限量要求。

**LEADER**

**LEADER ELECTRONICS CORP.**

2-6-33 Tsunashima-Higashi, Kohoku-ku, Yokohama 223-8505, Japan

PHONE:81-45-541-2123 FAX:81-45-541-2823 <http://www.leader.co.jp>