



- LA-261 Lavalier Microphone
- LA-262 Over-the-Head Microphone
- LA-270 Noise Canceling Microphone
- LA-272 Over-the-Head Microphone with Earphone
- LA-274 Hand Held Microphone
- LA-276 Collar Microphone
- LA-277 Conference Microphone
- LA-278 Behind-the-Head Microphone
- LA-279 Over-the-Ear Microphone - Presentation Style

Don't miss a single sound.





Dear Valued Customer,

Thank you for choosing Listen! All of us at Listen are dedicated to providing you with the highest quality products available. We take great pride in their outstanding performance because we care that you are completely satisfied. That's why we independently certify them to the highest quality standards and back them with a limited lifetime guarantee. We stand ready to answer any questions you might have during installation or in the operation of our products. Should you experience any problems whatsoever with your Listen products, we are ready to help you in any way we can with prompt, efficient customer care. Because at Listen, it's all about you! And should you have any comments on how we might improve our products or our service, we're here to listen.

Here's how to reach us:
+1.801.233.8992
+1.800.330.0891 North America
+1.801.233.8995 fax
support@listentech.com
www.listentech.com

Thank you and enjoy your listening experience!

Best regards,
Russell Gentner and the Listen Team

- In the few instances where repairs were needed, 99% of all clients indicated that they were happy with repair turn-around-times and 85% of the time, clients were without their product for less than 10 days!
- Overall client satisfaction of working with Listen was rated 4.8 out of 5.
- "Please continue with your excellent attitude toward customer satisfaction. You guys are great!"
- "I've never had such good service from any company. Keep up the good work!"
- "You stand behind your product wonderfully."

Microphones Table of Contents

Specifications	3
----------------	---

Microphones	5
Sensitivity Settings	5
LA-261 Lavalier Microphone	6
LA-262 Over-the-Head Microphone	7
LA-270 Noise Canceling Microphone	8
LA-272 Over-the-Head Microphone with Earphone	9
LA-274 Hand Held Microphone	10
LA-276 Collar Microphone	11
LA-277 Conference Microphone	12
LA-278 Behind-the-Head Microphone	13
LA-279 Over-the-Ear Microphone - Presentation Style	14

Supplementary Information	15
Troubleshooting	15
Warranty	16
Contacting Listen	16
Optional Accessories	17

Microphone Specifications

Specification LA-261	
Description	High performance lavalier microphone, omni-directional, electronic condenser. Black. Clip included.
Frequency Response	20 Hz - 15 KHz
Impedance	less than 2.2K Ohms
DL Bias	3 VDC required
Connector	3.5 mm mono
Cable Length	36.00 in. (92.0 cm)
Weight	4 oz. (113 g)
Accessories	None

Specification LA-270	
Description	Head-worn, noise-canceling condenser microphone, uni-directional. Black. Wind screen included.
Frequency Response	300 Hz - 10 KHz
Impedance	1K Ohms
DL Bias	3 VDC required
Connector	3.5 mm mono
Cable Length	55.00 in. (1.4 m)
Weight	2 oz. (59 g)
Accessories	None

Specification LA-262	
Description	Head-worn, uni-directional, electronic condenser microphone. Black. Clip and wind screen included.
Frequency Response	30 Hz - 5 KHz
Impedance	680 Ohms
DL Bias	3 VDC required
Connector	3.5 mm mono
Cable Length	36.00 in. (92.0 cm)
Weight	8 oz. (227 g)
Accessories	LA-264 Replacement Cushions for Over-the-Head Microphone (1 set)

Specification LA-272	
Description	Head-worn, uni-directional, electronic condenser microphone. Black. Clip and wind screen included.
Frequency Response	30 Hz - 5 KHz
Impedance	680 Ohms
DL Bias	3 VDC required
Connector	3.5 mm mono
Cable Length	36.00 in. (92.0 cm)
Weight	8 oz. (227 g)
Accessories	LA-264 Replacement Cushions for Over-the-Head Microphone

Specification LA-274	
Description	High performance hand held, omni-directional, electronic condenser microphone. Black. Wind screen and wire stand included
Frequency Response	20 Hz - 15 KHz
Impedance	less than 2.2K Ohms
DL Bias	3 VDC required
Connector	3.5 mm mono
Cable Length	36.00 in. (92.0 cm)
Weight	4 oz. (113 g)
Accessories	None

Specification Earphone	
Description	Single ear receiver. Black
Frequency Response	20 KHz - 15 KHz
Impedance	32 Ohms
Max Input	130 mW maximum
Connector	3.5 mm mono
Accessories	Ear Cushions

Specification LA-277	
Description	High performance omni-directional microphone, electronic condenser. Black
Frequency Response	20 Hz - 12 KHz
Impedance	1K Ohms
DL Bias	1.5 VDC required
Mic Height	2.30 in. (58 mm)
Mic Diameter	1.4 in. (35 mm)
Connector	3.5 mm mono
Cable Length	48.00 in. (1.2 m)
Weight	4 oz. (113 g)
Accessories	None

Specification LA-276	
Description	Shoulder/neck-worn, uni-directional microphone. Black. Flexible body. Wind screen included.
Frequency Response	300 Hz - 18 KHz
Impedance	1K Ohms
DL Bias	1.5 VDC required
Mic Length	22.00 in. (55.9 cm)
Connector	3.5 mm mono
Cable Length	48.00 in. (1.2 m)
Weight	4 oz. (113 g)
Accessories	None

Microphone Specifications (cont.)

Specification	LA-278
Description	High performance omni-directional microphone, electronic condenser. Black
Frequency Response	150 Hz - 10 KHz
Impedance	2K Ohms
DL Bias	3 VDC required
Mic Length	4.50 in. (11.5 cm)
Connector	3.5 mm mono
Cable Length	52.00 in. (1.3 m)
Weight	1.5 oz. (42.5 g)
Accessories	None

Specification	LA-279
Description	Head-worn microphone, omni-directional, electronic condenser microphone, tan colored.
Frequency Response	50 Hz - 18 KHz
Impedance	1,500 Ohms \pm 30% (at 1 KHz)
DL Bias	3 VDC required
Connector	3.5 mm mono
Cable Length	36.00 in. (92 cm)
Weight	4.8 oz. (136 g)
Accessories	None

Microphones

Introduction

Your Listen microphone is designed to provide high quality audio when used with a Listen LT-700 Portable FM Display Transmitter. Listen microphones will work with LT-700 units on either 72 MHz or 216 MHz. Your Listen microphone will also work with any product that supplies 3 VDC phantom power and conforms to the diagram below.

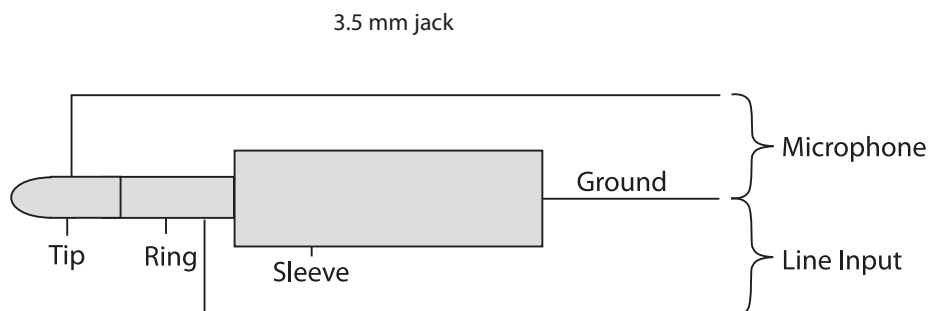

To achieve the desired audio quality from your Listen microphone, it is important to use it as instructed. The instructions for your microphone provide guidelines on placement and use.

If you experience trouble with your microphone, check the troubleshooting section of this manual first to try to resolve the problem. If you are still having difficulties, contact Listen support (support information available in the back of this manual).

Important Information About Microphone Sensitivity Settings

When you connect your Listen Microphone to your LT-700 Portable FM Display Transmitter, you must make sure that the microphone sensitivity switch (located inside the front cover of the LT-700) is set to the sensitivity specified for your microphone. If this switch is not in the correct position, your audio may sound low or distorted. Please note the sensitivity setting for your microphone and check the switch setting in the LT-700 prior to using your Listen equipment.

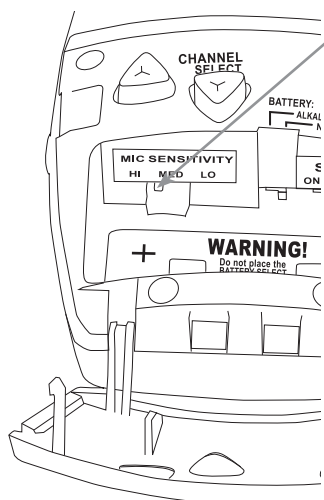

The microphone sensitivity switch is located inside the front cover of the LT-700.

Part #	Microphone	Type	Mic sensitivity Switch Position
LA-261	Lavalier Microphone	omni-directional	MED
LA-262	Over-the-Head Microphone	uni-directional	MED
LA-270	Noise Canceling Microphone	uni-directional	MED
LA-272	Over-the-Head Mic with Earphone	uni-directional	MED
LA-274	Hand Held Microphone	omni-directional	HI
LA-276	Collar Microphone	uni-directional	HI
LA-277	Conference Microphone	omni-directional	HI
LA-278	Behind-the-Head Microphone	uni-directional	MED
LA-279	Over-the-Ear Microphone-Presentation Style	omni-directional	MED

LA-261 Lavalier Microphone

The LA-261 Lavalier Microphone is a high performance, non-directional microphone that clips on your collar or lapel.

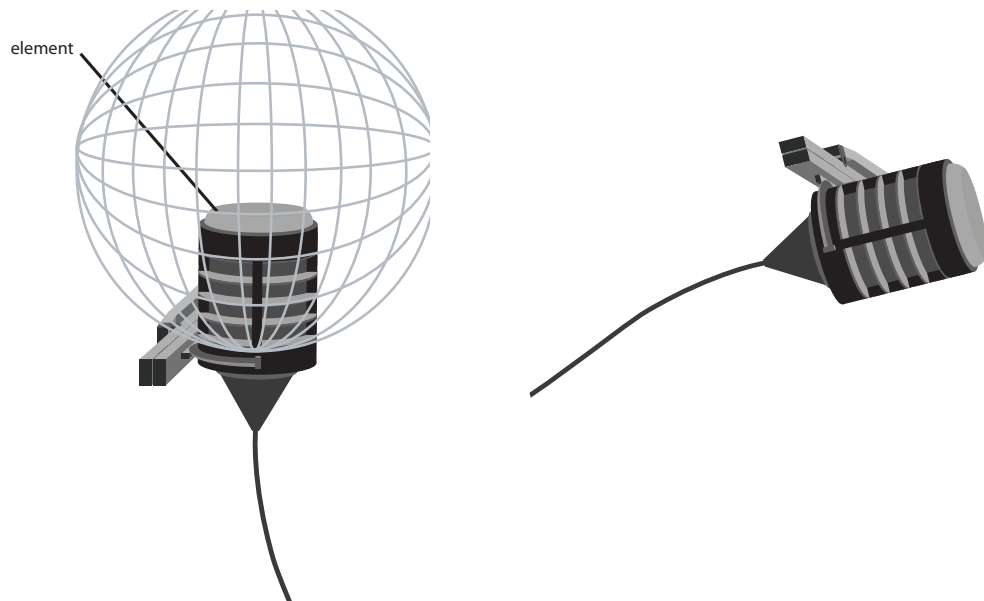

The LA-261 has an omni-directional pickup pattern. This means that audio from a broader area can be picked up by the microphone element. The main advantage of this type of microphone is that it does not have to be oriented directly towards your mouth for good audio pickup.

Using the LA-261 Lavalier Microphone

- Set the microphone sensitivity switch (located inside front cover of the LT-700 Portable FM Display Transmitter) to the MED position.
- Clip the microphone as close as possible to your mouth. For best results the mic element should be no more than 6 inches from your mouth. This will help to ensure that the microphone picks up your voice rather than room noise.
- Make sure the microphone is not rubbing on your face or clothing.
- Connect the plug firmly to the microphone connector on the LT-700.



LA-262 Over-the-Head Microphone

The LA-262 Over-the-Head Microphone provides high quality audio pickup with its directional boom microphone.

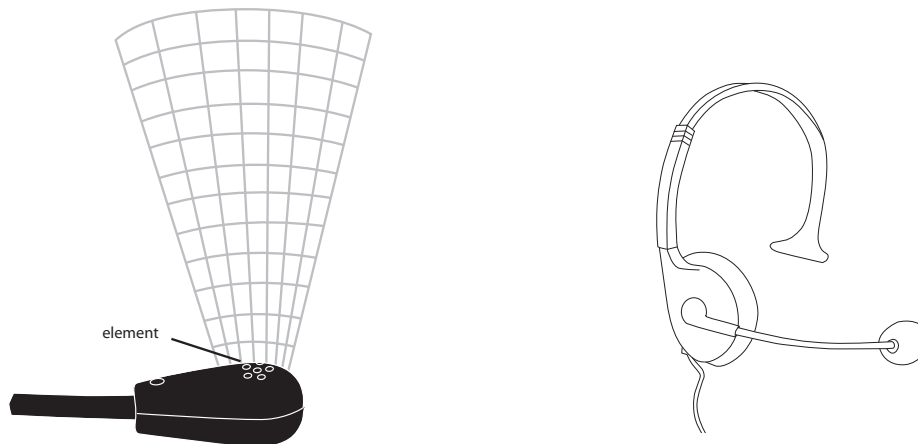

The LA-262 has a uni-directional pickup pattern. This means that the microphone's element must be oriented towards your mouth. It will not pick up audio very well from the side of the microphone. The main advantage of this type of microphone is that it helps minimize feedback and picks up less environmental noise.

Using the LA-262 Over-the-Head Microphone

- Set the microphone sensitivity switch (located inside front cover of the LT-700 Portable FM Display Transmitter) to the MED position.
- Place the unit over your head and position the microphone as close as possible to your mouth. For best results the mic element should be 1 to 2 inches from your mouth. This will help to ensure that the microphone picks up your voice rather than room noise.
- Make sure the microphone is not rubbing on your face or clothing.
- Connect the plug firmly to the microphone jack on the LT-700.



LA-270 Noise Canceling Microphone

The LA-270 Noise Canceling Microphone provides high quality audio pickup with its directional boom microphone. Its noise canceling technology makes it ideal for noisy environments such as factory tours.

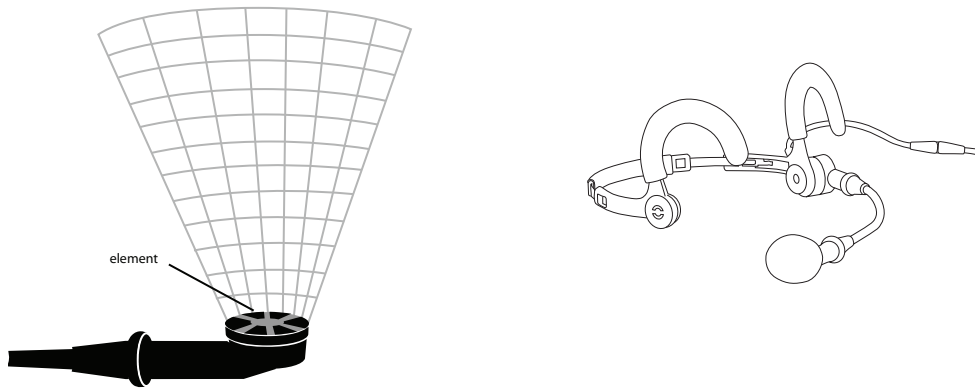

The LA-270 has a uni-directional pickup pattern. This means that the microphone's element must be oriented towards your mouth. It will not pick up audio very well from the side of the microphone. The main advantage of this type of microphone is that it helps minimize feedback and picks up less environmental noise.

Using the LA-270 Noise Canceling Microphone

- Set the microphone sensitivity switch (located inside front cover of the LT-700 Portable FM Display Transmitter) to the MED position.
- Place the unit over your ears, wrapping it behind your head. Position the microphone as close as possible to your mouth. For best results the mic element should be 1 to 2 inches from your mouth. This will help to ensure that the microphone picks up your voice rather than room noise.
- Connect the plug firmly to the microphone jack on the LT-700.



LA-272 Over-the-Head Microphone with Earphone

The LA-272 Over-the-Head Microphone provides high quality audio pickup with its directional boom microphone. It allows you to simultaneously transmit on a LT-700 and receive audio on a Listen portable receiver.

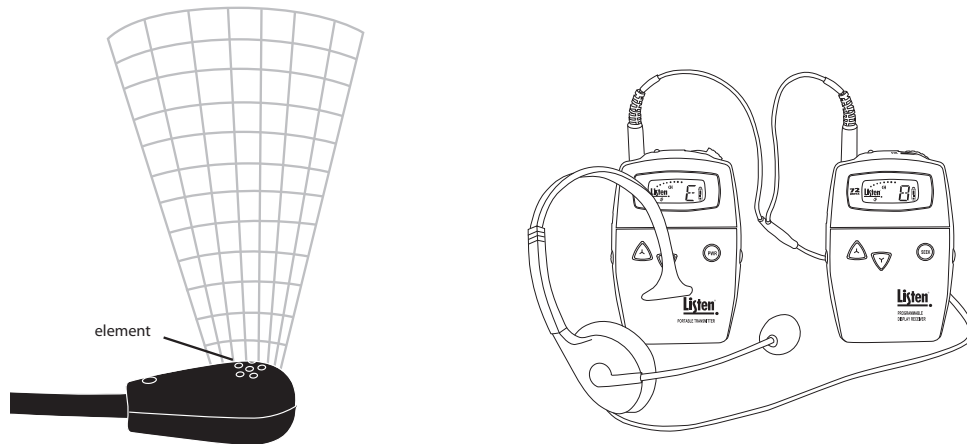

The LA-272 has a uni-directional pickup pattern. This means that the microphone's element must be oriented towards your mouth. It will not pick up audio very well from the side of the microphone. The main advantage of this type of microphone is that it helps minimize feedback and picks up less environmental noise.

Using the LA-272 Over-the-Head Microphone with Earphone

- Set the microphone sensitivity switch (located inside front cover of the LT-700 Portable FM Display Transmitter) to the MED position.
- Place the unit over your head and position the microphone as close as possible to your mouth. For best results the mic element should be 1 to 2 inches from your mouth. This will help to ensure that the microphone picks up your voice rather than room noise.
- Connect the earphone plug firmly to the earphone jack on the Listen receiver.
- Connect the microphone plug firmly to the microphone jack on the LT-700.



LA-274 Hand Held Microphone

The LA-274 Hand Held Microphone provides high quality audio pickup with its non-directional pickup pattern. Its small size makes it easy to use. The unit can be held in the hand, or placed in a stand on a table, as shown below.

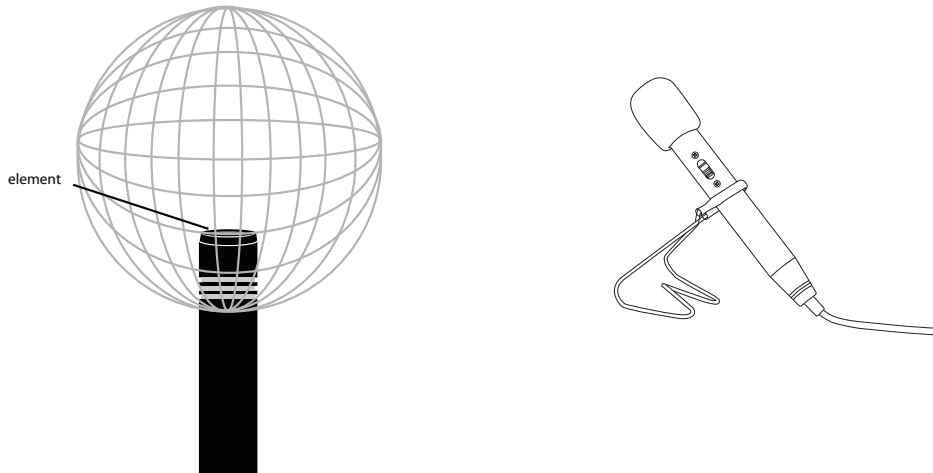

The LA-274 has an omni-directional pickup pattern. This means that audio from a broader area can be picked up by the microphone element. The main advantage of this type of microphone is that it does not have to be oriented directly towards your mouth for good audio pickup.

Using the LA-274 Hand Held Microphone

- Set the microphone sensitivity switch (located inside front cover of the LT-700 Portable FM Display Transmitter) to the HI position.
- Connect the microphone plug firmly to the microphone jack on the LT-700.
- To use, slide the switch on the side of the microphone to the ON position (toward the mic element). For best results the mic element should be no more than 6 inches from your mouth. To mute your audio, slide the switch to the OFF position (toward the cord).
- A stand is provided (see illustration on page 13) for optional hands-free use. When using the stand, try to place the mic as close to your mouth as possible.

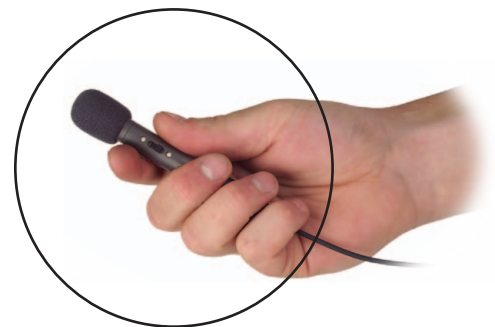

LA-276 Collar Microphone

The LA-276 Collar Microphone provides high quality audio pickup with its directional boom microphone. It is ideal for users who don't want to wear something on their heads or ears.

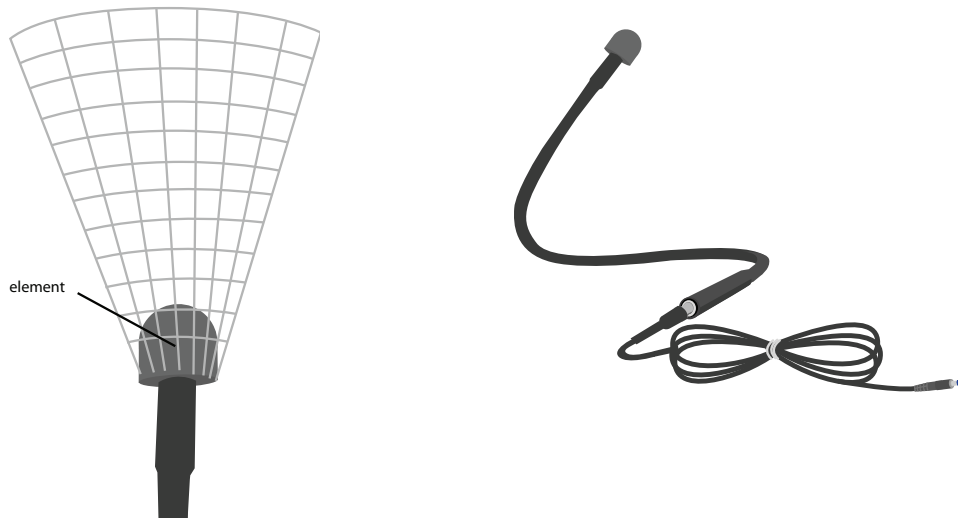

The LA-276 has a uni-directional pickup pattern. This means that the microphone's element must be oriented towards your mouth. It will not pick up audio very well from the side of the microphone. The main advantage of this type of microphone is that it helps minimize feedback and picks up less environmental noise.

Using the LA-276 Collar Microphone

- Set the microphone sensitivity switch (located inside front cover of the LT-700 Portable FM Display Transmitter) to the HI position.
- Connect the microphone plug firmly to the microphone jack on the LT-700.
- Place the collar ring around your neck and position the microphone so that it is in front of your mouth and as close to your mouth as possible without rubbing on your face or clothing. For best results the mic element should be 1 to 2 inches from your mouth.
- For best results bend the microphone wire to fit snugly around the speakers neck.



LA-277 Conference Microphone

The LA-277 Conference Microphone provides high quality audio pickup in all directions. It is designed to be used on a table or other flat surfaces. This is an ideal microphone for multiple users of one transmitter.

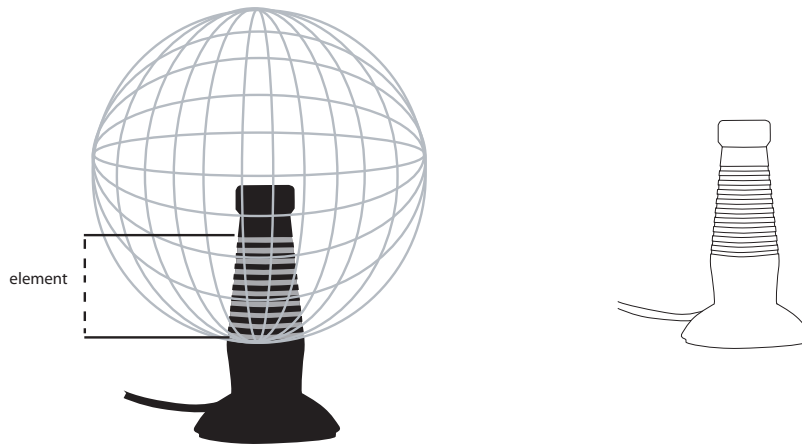

The LA-277 has an omni-directional pickup pattern. This means that audio from a broader area can be picked up by the microphone element. The main advantage of this type of microphone is that it does not have to be oriented directly towards your mouth for good audio pickup.

Using the LA-277 Conference Microphone

- Set the microphone sensitivity switch (located inside front cover of the LT-700 Portable FM Display Transmitter) to the HI position.
- Connect the microphone plug firmly to the microphone jack on the LT-700.
- Place the unit on the table, clear of any obstructions that might interfere with its pick up of voices. For best quality, users should be as close to the microphone as possible (the ideal range is 2 to 3 feet). The closer you are to the microphone, the better it will sound.



LA-278 Behind-the-Head Microphone

The LA-278 Behind-the-Head Microphone provides excellent audio quality with its directional capabilities. This microphone fits securely behind the head (below the hairline) and over the ears. This design allows the user to adjust the size to fit on the speakers head comfortably for extended periods of time.

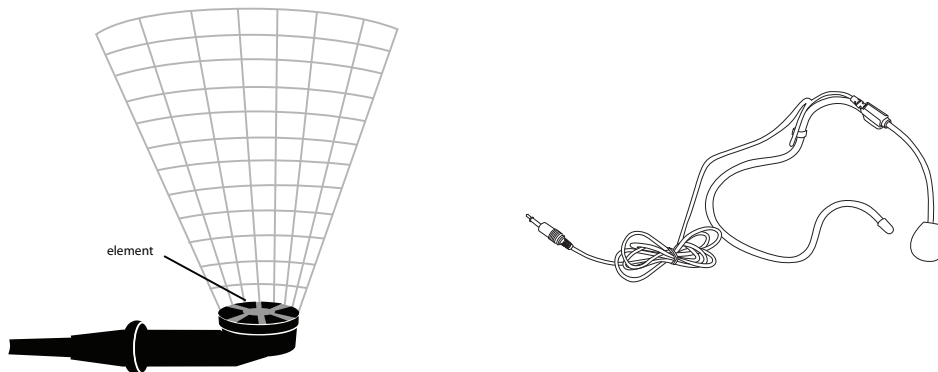

The LA-278 has a uni-directional pickup pattern. This means that the microphone's element must be oriented towards your mouth. It will not pick up audio very well from the side of the microphone. The main advantage of this type of microphone is that it helps minimize feedback and picks up less environmental noise.

Using the LA-278 Behind-the-Head Microphone

- Set the microphone sensitivity switch (located inside front cover of the LT-700 Portable FM Display Transmitter) to the MED position.
- Place the unit behind your head, below the hairline stretching the wire to fit comfortable over your ears. Position the microphone as close as possible to your mouth. For best results the mic element should be 1 to 2 inches from your mouth. This will help to ensure that the microphone picks up your voice rather than room noise.
- Connect the microphone plug firmly to the microphone jack on the LT-700.



LA-279 Over-the-Ear Microphone- Presentation Style

The LA-279 Over-the-Ear Microphone-Presentation Style provides high quality audio pickup with its omni-directional microphone.

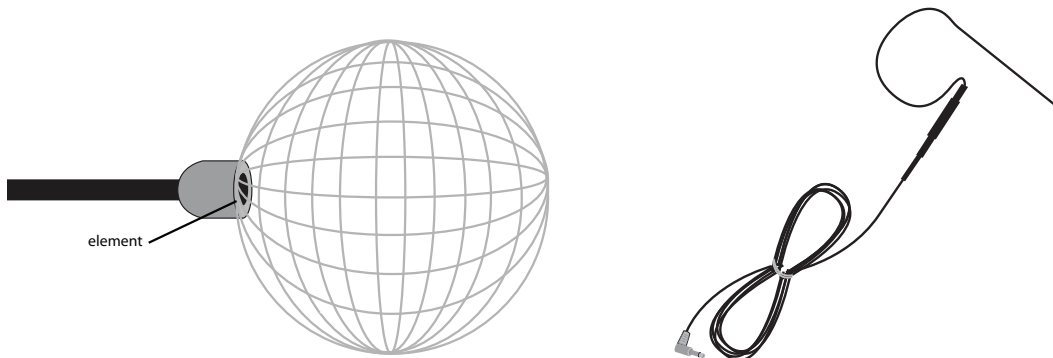

The LA-279 has an omni-directional pickup pattern. This means that audio from a broader area can be picked up by the microphone element. The main advantage of this type of microphone is that it does not have to be oriented directly towards your mouth for good audio pickup.

Using the LA-279 Over-the-Ear Microphone- Presentation Style

- Set the microphone sensitivity switch (located inside front cover of the LT-700 Portable FM Display Transmitter) to the MED position.
- Place the unit over your ear and position the microphone as close as possible to your mouth. For best results the mic element should be 1 to 2 inches from your mouth. This will help to ensure that the microphone picks up your voice rather than room noise.
- Connect the microphone plug firmly to the microphone jack on the LT-700.



Troubleshooting

My microphone doesn't work.

Check to make sure your LT-700 transmitter is turned on and that the batteries are charged. Make sure your microphone cable is plugged firmly into the microphone jack on the LT-700. Make sure the LT-700's MUTE switch is in the correct position. LA-274: make sure the microphone's ON/OFF switch is in the correct position.

My microphone audio sounds distorted or "fuzzy".

Make sure the Mic Sensitivity Switch (inside cover of LT-700) is set to the correct position for your microphone. Make sure you are speaking in a normal voice. If you speak too loudly, your audio will be distorted.

My microphone works, but the audio is very low.

Make sure the microphone is connected firmly in the LT-700 Transmitter. Make sure the microphone is positioned so the mic element points directly at your mouth. Refer to individual microphone page to confirm correct orientation. Make sure the Mic Sensitivity Switch (inside front cover of the LT-700) is in the correct position for your microphone. See page 5 to verify correct setting for your microphone.

Transmission seems to stop or audio cuts out.

Make sure the microphone is firmly plugged into to the LT-700. Make sure the batteries in the LT-700 are fully charged.

Warranty & Contacting Listen

Warranty

Listen Technologies Corporation (Listen) warrants its transmitters and receivers (LT-82, LT-700, LT-800, LR-100, LR-42, LR-44, LR-300, LR-400, LR-500, LR-600) to be free from defects in workmanship and material under normal use and conditions for the useful lifetime of the product from date of purchase.

Listen warrants its Stationary IR Radiators (LA-140) to be free from defects in workmanship and material under normal use and conditions for three years from the date of purchase.

Listen warrants its Noise Canceling Microphone (LA-270) to be free from defects in workmanship and material under normal use and conditions for one year from date of purchase.

Listen warrants its Charging/Carrying Cases (LA-306, LA-311, LA-313, LA-317, LA-318, LA-319, LA-320, LA-321, LA-322, LA-323, LA-324, LA-325) to be free from defects in workmanship and material under normal use and conditions for one year from date of purchase.

All other products and accessories are warranted for 90 days from date of purchase.

This warranty is only available to the original end purchaser of the product and cannot be transferred. Warranty is only valid if warranty card has been returned within 90 days of purchase. This warranty is void if damage occurred because of misuse or if the product has been repaired or modified by anyone other than a factory authorized service technician. Warranty does not cover normal wear and tear on the product or any other physical damage unless the damage was the result of a manufacturing defect. Listen is not liable for consequential damages due to any failure of equipment to perform as intended. Listen shall bear no responsibility or obligation with respect to the manner of use of any equipment sold by it. Listen specifically disclaims and negates any warranty of merchantability or fitness of use of such equipment including, without limitation, any warranty that the use of such equipment for any purpose will comply with applicable laws and regulations. The terms of the warranty are governed by the laws of the state of Utah.

In the first ninety days after purchase, any defective product will be replaced with a new unit. After 90 days, Listen will, at its own discretion either repair or replace transmitters and receivers with a new unit or a unit of similar type and condition. Product that is not covered under warranty shall be repaired or replaced with a unit of similar type and condition based on a flat fee. Contact Listen for details.

This limited warranty, prices and the specifications of products are subject to change without notice.

Contacting Listen

If technical service is needed, please contact Listen. Pre-authorization is required before returning Listen products. If products were damaged in shipment, please contact the carrier, then contact Listen for replacement or repair requirements payable by the carrier.

Listen's corporate headquarters are located in Bluffdale, Utah U.S.A. and are open Monday through Friday, 8am to 5pm Mountain Time.

14912 Heritagecrest Way
Bluffdale, Utah 84065-4818
+1.801.233.8992
+1.800.330.0891 North America
+1.801.233.8995 fax

support@listentech.com
www.listentech.com

Listen Technologies GmbH
Jasminstr.16, 90522 Oberasbach, Germany
+49 911 955 159 0 Europe
+49 911 955 159 40 Fax
support@listentech.de
www.listentech.de

Optional Accessories

Cable Accessories



LA-263

Line/Mic Y Input Cable for LT-700

This cable makes it easy to use a line level source (such as a CD player) along with your microphone. It provides one 3.5 mm male jack, and splits to one RCA phono connector (line input to LT-700) and one 3.5mm female connector (Mic input to LT-700). The cable length of 48 in. (122 cm) serves as an antenna for the LT-700 as well.



LA-275

Portable Unit Sacrificial Cable

This earphone/microphone connection cable relieves strain on your other cables, increasing the life of your microphone or earphone. It provides 3.5 mm mono male and female connectors with a 6 in. (15.2 cm) cable.



LA-280

LT-800 Microphone 1/4 in. to
3.5 mm Adapter

This adapter enables a user to plug a mic with a 1/8 in. (3.5 mm) tip into the 1/4 connector of the LT-800.

Notes

Notes



Listen Technologies Corporation
14912 Heritagecrest Way
Bluffdale, Utah 84065-4818, U.S.A.
+1.801.233.8992
+1.800.330.0891 North America
+1.801.233.8995 fax

www.listentech.com

© 2008 Listen Technologies Corporation® All Rights Reserved 081308