

VideoEase™ CATV Distribution Hub (500300, 500301, 500303, 500304)



Installation Guide

P/N: 94-000620-B

MuxLab

Copyright Notice :

Copyright © 2012 MuxLab Inc. All rights reserved.

Printed in Canada. No part of this publication may be reproduced, stored in a retrieval system, or transmitted in any form or by any means, electronic, mechanical, photocopying, recording, or otherwise without prior written permission of the author.

Trademarks :

MuxLab and VideoEase are registered trademarks of MuxLab Inc.

Table of Contents

1. Overview	4
1.1. Description.....	4
1.2. Features.....	4
2. Technical Specifications	5
3. Installation Procedure	7
3.1. Parts List	7
3.2. Product Overview	8
3.3. Pre-Installation Checklist	9
3.4. Pre-Installation Tips	9
3.5. Physical Installation.....	10
3.6. Installation Procedure	11
4. Troubleshooting	14
5. Product Warranty Policy	15

1. Overview

1.1. Description

The VideoEase CATV Distribution Hub allows a terrestrial broadband RF video signal to be distributed to multiple RF receivers via Cat5 unshielded twisted pair cable. The CATV Distribution Hub is available in two (2) configurations; Eight (8) ports: 500300/500301 and sixteen (16) ports: 500303/500304.

The CATV Distribution Hub works in conjunction with MuxLab's passive CATV Balun and other RF video equipment for a more complete cabling solution. The CATV Distribution Hub has a 900 MHz bandwidth and supports broadband video and Internet. The product features built-in gain amplification and port buffering and may be used in conjunction with standard RF distribution equipment for larger installations

1.2. Features

- 900 MHz bandwidth
- Built-in RF amplifier
- Bi-directional transmission
- Works with other standard RF video equipment
- Compact design

2. Technical Specifications

Environment	Broadband CATV, VHF, FM, broadband Internet, digital cable.	
Devices	Set-top tuners, RF splitters, RF amplifiers, modulators, combiners, re-processors, cable modems	
Frequency Band Supported	CATV: 54-900 MHz, RETURN CHANNEL: 5-42MHz	
	8P (500300/500301)	16P (500303/500304)
Insertion Gain per pair – Forward path (S₂₁)	55-450 MHz: >12 dB 450-900 MHz: >10 dB	55-450 MHz: >12 dB 450-900 MHz: >10 dB
Insertion Gain per pair – Reverse path (S₁₂)	5-42 MHz: >0 dB	5-42 MHz: >0 dB
Return Loss	> 5 dB from 5 to 42MHz > 6 dB from 54 to 900 MHz	> 5 dB from 5 to 42MHz > 6 dB from 54 to 900 MHz
Common Mode Rejection Ratio	> 30 dB from 5 to 900 MHz	> 30 dB from 5 to 900 MHz
Mounting	Desktop	1U Rack-mount
Dimensions	9.3" x 3.9" x 1.6" (23.5 x 9.9 x 4 cm)	19" x 3.9" x 1.75" (48.3 x 9.9 x 4.4 cm)
Weight	28 oz (817 g)	41 oz (1.2 kg)
Maximum Distance - Cat 5 UTP	Dependant on channel frequency, input power and receiver sensitivity.	

LED Indicators	Power: One (1) green LED.
Cable – UTP	CAT5/5e or CAT6 24 gauge or lower solid copper twisted pair wire.
Cable – “F”	Impedance: 75 ohms at 1 MHz (RG6)
Connectors	RF Input: “F” connector RF Outputs: Eight (8) or sixteen (16) RJ45S depending on model
RJ45 Pin Configuration	RJ45 Pins 7 & 8
Compatible MuxLab Baluns	500006 (550MHz), 500302 (900 MHz)
Power Requirement	12VDC @ 400 mA
Power Supply	Desktop 110-240V switching power supply. Input: 100-240V, ~0.5A Max, 50-60Hz Output: +12V, 1.25A. Output Power: 15W Max. Detachable AC power cord
Temperature	Operating: 0° to 40°C. Storage: -10° to 70°C. Humidity: up to 95% non-condensing
Enclosure	Black painted aluminum
Regulatory	FCC, CE, RoHS
Warranty	2 years
Order Information	500300 CATV Distribution Hub, 8 Ports, 110V 500301 CATV Distribution Hub, 8 Ports, 220-240V 500303 CATV Distribution Hub, 16 Ports, 110V 500304 CATV Distribution Hub, 16 Ports, 220-240V

3. Installation Procedure

3.1. Parts List

The CATV Distribution Hub comes with the following parts. Please verify that all pieces are present before proceeding.

- Base Unit
- External Power Supply 12VDC/1.25 A
- Rubber stand-off (500300, 500301 only)
- Installation Guide

3.2. Product Overview

The external connections and diagnostics of CATV Distribution Hub are detailed in the following diagrams. Please familiarize yourself with them before installing the unit.

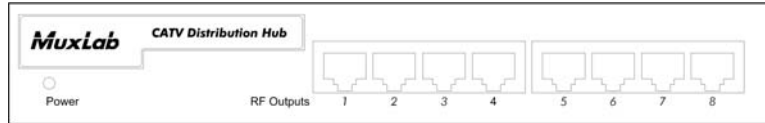

Figure 1: CATV Distribution Hub 8P (500300, 500301) Front panel



Figure 2: CATV Distribution Hub 8P (500300, 500301) Rear panel

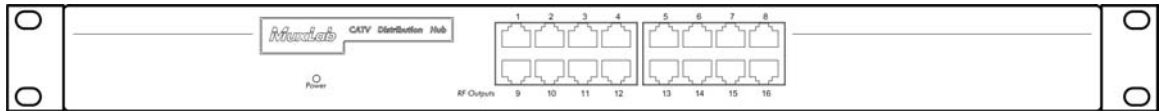

Figure 3: CATV Distribution Hub 16P (500303, 500304) Front panel



Figure 4: CATV Distribution Hub 16P (500303, 500304) Rear panel

3.3. Pre-Installation Checklist

The CATV Distribution Hub provides a centralized CATV copper twisted pair cabling solution.

1. The CATV Distribution Hub is always connected to the terrestrial CATV cable feed within a building. For example it is connected directly to the output of a CATV head end feeding from equipment such as an RF splitter, RF amplifier or RF modulator.
2. The CATV Distribution Hub must be used in conjunction with MuxLab's passive CATV Baluns (p/n 500006, 500302). The CATV Baluns are connected at each RF receiver, tuner or cable modem.
3. Don't cascade Distribution Hub.

3.4. Pre-Installation Tips

1. In a point-to-point scenario for CATV, VHF and FM, cable lengths of up to 45 meters may be achieved if the nominal input is about 5dBV. If signal is higher than 10 dBmV, it may be necessary to attenuate the lower frequency or reduce the signal level in order to avoid over-driving the TV or modem.
2. When combining an existing signal with a modulated signal, make sure to have equal signal strength at the point of the combiner so one signal does not degrade the other.
3. When possible, use the lowest frequencies available for the modulated channels. Lower frequency channels have lower signal loss on the cable runs. Don't drive the cable with more than 10dBmV.

3.5. Physical Installation

The CATV Distribution Hub has two models; 8-port desktop (500300, 500301) and 16-port rack-mount (500303, 500304).

1. If the 8-port hub is being installed desk, select the final destination for the product and install the unit on a desk to shelf as shown below.



Figure 5: 8-port desktop installation

2. If the 16-port hub is being installed, select the final destination for the product and install the unit in a 19" relay rack using standard rack mount screws.



Figure 6: 16-port rack mount installation

3.6. Installation Procedure

The CATV Distribution Hub is available in 8-port (500300, 500301) and 16-port (500303, 500304) versions. In order to install the product, please follow the steps below:

1. Perform steps 1 to 2 listed in the previous section.
2. Ensure that the power is turned off on CATV equipment.
3. Connect one (1) coax cable from CATV head end to the RF input on the CATV Distribution Hub.

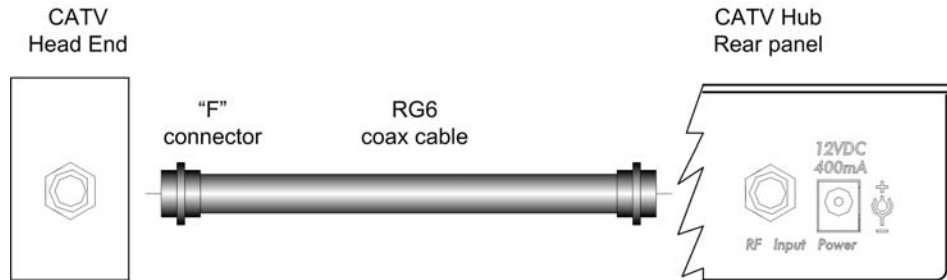
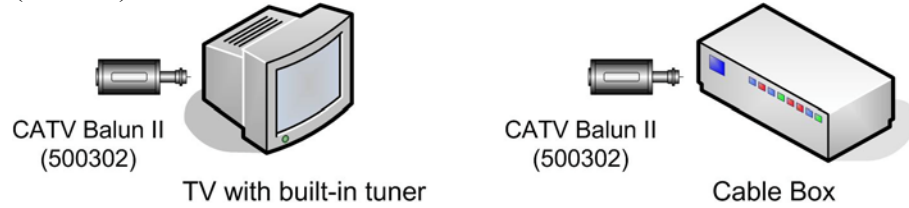

Figure 2: CATV Distribution Hub

4. Connect the external 12VDC power supply to the hub and plug the power supply into an AC power outlet. If power is present, then the green power LED will be ON.

5. At each RF receiver/tuner or cable modem, connect a CATV Balun II (500302).



6. Connect a Cat5 (or better) cable between the CATV Distribution Hub and each CATV Balun II. Please note that only one twisted pair is required. The three (3) unused twisted pairs may be used for other low voltage services, including low voltage power, data, voice, video, audio and IR.

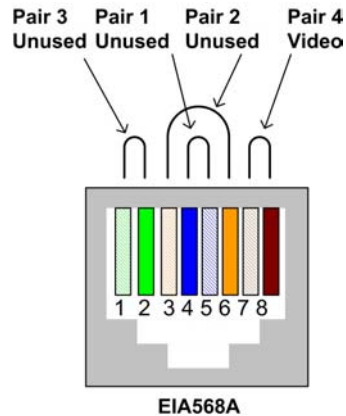

7. Power on the CATV Distribution Hub and each receiver/tuner/cable modem.
8. At each receiver/tuner, select each video channel to ensure that each channel is received clearly. If the images on some channels are not clear, please consult the Troubleshooting section of this installation guide.
9. If a cable modem is connected, test the Internet connection to ensure that both upstream and downstream communications are functional. If not, please consult the Troubleshooting section of this installation guide.
10. The following diagrams show a couple of typical configurations.

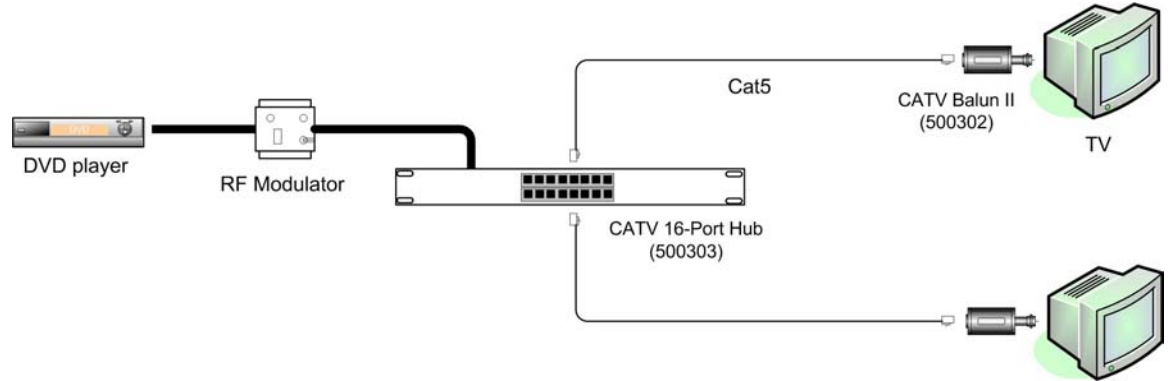

Figure 3: Typical Configuration, RF Modulation

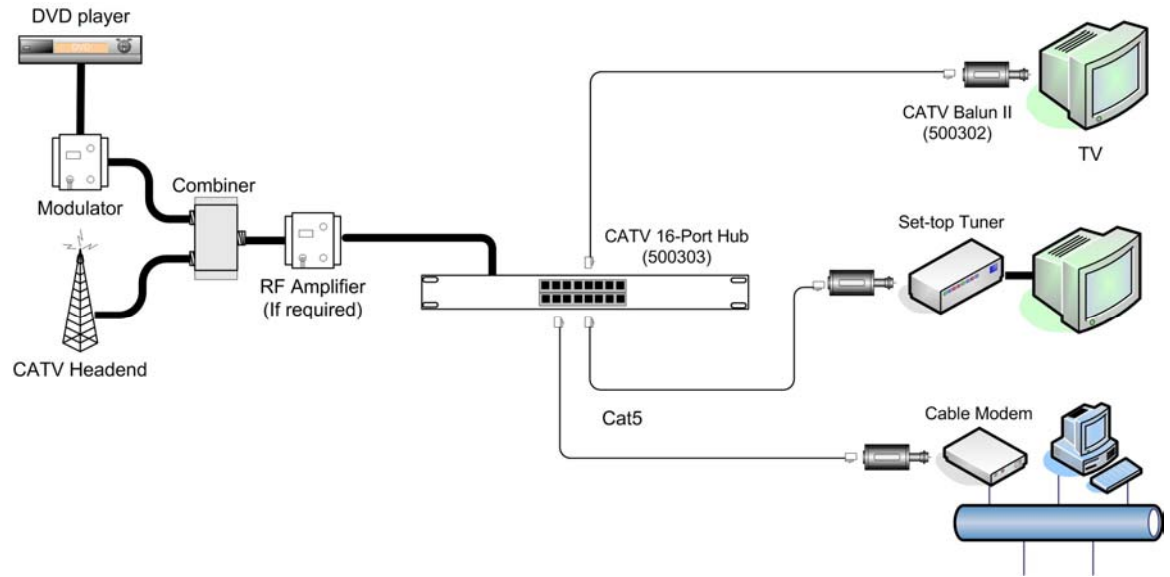

Figure 4: Typical Configuration, CATV & RF Modulation

4. Troubleshooting

The following table describes some of the problem symptoms, the probable causes and possible solutions. If the information below does not solve the problem, the technical support contact information can be found at the end of this section.

Picture	Power LED	Probable Causes	Possible Solutions
No image	OFF	Power off	Check power supplies of CATV equipment
No image or very noisy	ON	Wrong pin configuration	Check pin configuration and verify straight-through wiring
Picture snowy	ON	Exceeded distance/bandwidth specifications	Check if distance spec is exceeded
		Lower grade UTP cable is introducing high losses	Reduce cable length. Replace cable by higher grade
		Insufficient signal strength at input	Check level
Horizontal upward moving bands	ON	Ground loop problem.	Isolate CATV receiver from local ground.
Some channels do not come in	ON	Bandwidth limitation	Check that the channel frequency is within the bandwidth limitation of the baluns and hubs
Internet not functioning	ON	Unsupport by CATV system	Ensure that all RF components support bi-directional transmission
Over bright image	ON	Signal strength too high	Attenuate signal by reducing amplifier gain or by moving internal jumper.

When contacting your nearest MuxLab dealer or MuxLab Technical Support please have the following information ready:

- Unit model number.
- List of tests performed.
- Cabling lay-out. Include model of CATV receiver, cable modem, cable length and type.
- Description of problem.

5. Product Warranty Policy

Items under warranty - Company Policy

MuxLab guarantees its products to be free of defects in manufacturing and workmanship for the warranty period from the date of purchase. If this product fails to give satisfactory performance during this warranty period, MuxLab will either repair or replace this product at no additional charge, except as set forth below. Repair and replacement parts will be furnished on an exchange basis and will be either reconditioned or new. All replaced parts and products become the property of MuxLab. This limited warranty does not include repair services for damage to the product resulting from accident, disaster, misuse, abuse, or unauthorized modifications or normal decay of battery driven devices. Batteries if included with the product, are not covered under this warranty.

Limited warranty service can be obtained by delivering the product during the warranty period to the authorized MuxLab dealer from whom you purchased the product, or by sending it to MuxLab. MuxLab will not accept any such product for repair without a Return Material Authorization number (RMA#) issued by its Customer Service Department and a proof of purchase date. If this product is delivered to MuxLab by mail, you agree to assume risk of loss or damage in transit, to prepay shipping charges to the warranty service location, and to use the original shipping container or equivalent.

THE ABOVE LIMITED WARRANTY IS THE ONLY WARRANTY COVERING YOUR MUXLAB PRODUCT. THERE ARE NO OTHER WARRANTIES, EXPRESSED OR IMPLIED, INCLUDING WARRANTIES OF MERCHANTABILITY OR FITNESS FOR A PARTICULAR PURPOSE. SOME STATES DO NOT ALLOW LIMITATIONS ON IMPLIED WARRANTIES, SO THE ABOVE LIMITATION MAY NOT APPLY TO YOU.

IF THIS PRODUCT IS NOT IN GOOD WORKING ORDER, YOUR SOLE REMEDY SHALL BE REPAIR OR REPLACEMENT AS PROVIDED FOR ABOVE. IN NO EVENT SHALL MuxLab BE LIABLE TO YOU FOR ANY DAMAGES, INCLUDING ANY LOSS OF PROFITS, LOST SAVINGS, OR OTHER INCIDENTAL OR CONSEQUENTIAL DAMAGES ARISING OUT OF THE USE OF OR INABILITY TO USE THIS PRODUCT, EVEN IF MUXLAB OR AN AUTHORIZED MuxLab DEALER HAS BEEN ADVISED OF THE POSSIBILITY OF SUCH DAMAGES; NOR WILL MUXLAB BE LIABLE FOR ANY CLAIM BY ANY OTHER PARTY. SOME STATES DO NOT ALLOW THE EXCLUSION OR LIMITATION OF INCIDENTAL OR CONSEQUENTIAL DAMAGES FOR CONSUMER PRODUCTS, SO THE ABOVE LIMITATIONS OR EXCLUSIONS MAY NOT APPLY TO YOU. THIS WARRANTY GIVES YOU SPECIFIC LEGAL RIGHTS. YOU MAY ALSO HAVE OTHER RIGHTS WHICH MAY VARY FROM STATE TO STATE.

Warranty Periods

Any product found to be defective within three (3) months of invoice, including one (1) month shelf life, may be returned for replacement by a new unit or a satisfactory repair within one (1) month of receiving any returned product. The customer must provide MuxLab with the serial number and proof of purchase of the defective unit being returned. All R.M.A.'s issued are subject to inspection by MuxLab, and will be returned to customer if not properly package – units must be returned in original container or equivalent. MuxLab will not accept any such product for repair without an authorization for its Technical Support department and without a return authorization number issued by MuxLab Customer Service department. For credit & replace R.M.A., customer will be liable to pay replacement invoice if defective products are not returned. Product more than six months old, including shelf life.

The defective unit must be returned prepaid to MuxLab and then the unit will be repaired or if repair is not possible, replaced by an equivalent unit and returned to the customer within one (1) month of receiving any returned product.. There is no charge for repair (parts and labor) during the full warranty period.

Items Defective and not under Warranty

For products which are no longer under warranty the policy is repair and return. An amount of 25% of the products published list price at the time of purchase will be charged. Customer must issue a purchase order to cover the cost of repair. Each unit will be returned to the customer within one (1) month from receipt of the unit by MuxLab. The defective unit must be returned prepaid to MuxLab. The repaired unit will be returned to the customer FOB MuxLab. The repaired unit has a 90 day warranty.

MuxLab Inc.
8495 Dalton rd, Montreal,
Quebec, Canada, H4T 1V5

Tel.: (+1) 514 905-0588 Fax: (+1) 514 905-0589
Toll Free (North America): 877 689-5228

URL: www.muxlab.com
E-mail: videoease@muxlab.com