



HDMI/IP PTZ Camera Operation Manual (500791)



Preface

Thank you for purchasing the HDMI/IP PTZ Camera. This manual covers the camera functions, installation and operation. Prior to installation and usage, please read the manual thoroughly.

Precautions

This product must be used in the specified conditions in order to avoid damage to the camera:

- Do not subject the camera to rain or moisture.
- Do not remove the cover, otherwise you may get an electric shock and may void the warranty. In case of abnormal operation, contact the seller.
- Never operate beyond the specified temperature, humidity and power supply range.
- Please use a soft dry cloth to clean the camera. If the camera is very dirty, clean it with a diluted neuter detergent; do not use any type of solvents which may damage the surface.

Note

This is class A product. Electromagnetic radiation at the specific frequency may affect the image quality of a TV in a home environment

Copyright Notice

All contents in this manual is copyrighted, and cannot be cloned, copied or translated without the express permission of MuxLab Inc. Product specifications and information in this document are for reference only, and the content may be updated from time to time without prior notice.

Contents

Safety Notice.....	4
Supplied Accessories.....	4
Quick Start	5
Features	6
Specification	7
Main Unit Connections	9
IR Handheld Remote Control.....	10
RS-232 Interface Pinout.....	13
Serial Communication Control	14
PTZ over TCP/UDP Control	14
Command List.....	14
Menu Settings	15
Network Function	20
Maintenance and Troubleshooting	29
Appendix – Visca and Pelco-D Comment List	31

Safety Notice

● Electric Safety

Installation and operation must be in accordance with national and local electric safety standards.

Do not use any power supply other than the one originally supplied with this camera.

● Caution when transporting

Avoid stress, vibration and shock during transport, storage and installation.

● Polarity of power supply

The power supply of the product is +12V @ 2A (max). The polarity of the power supply plug is shown below.



● Care during installation

Do not grasp the camera head when carrying the camera. Do not turn camera head by hand. Doing so may result in mechanical damage.

Do not apply any corrosive form of liquid, gas or solid to the camera to avoid damaging the plastic cover.

To make sure there are no obstacles in the camera rotation range.

Never power on the camera before the installation is complete.

● Do not dismantle the camera in any way

MuxLab is not responsible for damage caused by unauthorized modification or dismantling.

CAUTION!

Specific frequencies of electromagnetic fields may affect the image quality of the camera!

Supplied Accessories

When unpacking, check that all supplied accessories are included:

- One (1) Camera
- One (1) AC power adaptor
- One (1) Power cord
- One (1) RS232 cable
- One (1) IR handheld remote control
- One (1) User manual (available via download)

Quick Start

Step1. Please check that connections are correct before continuing.

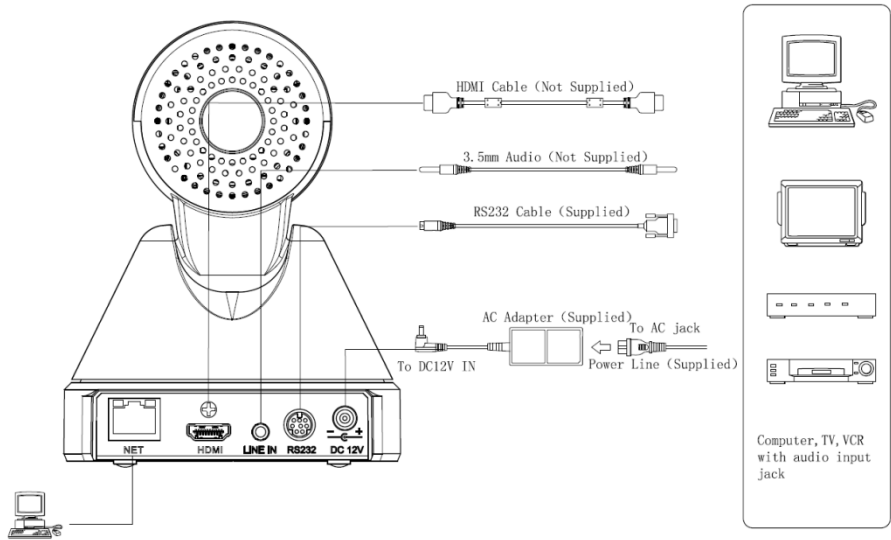

Step2. Connect the power on the rear panel of the camera, and the power LED on the front will illuminate.

Step3. During the power On sequence the Pan-Tilt function rotates the camera to its maximum upper right position, and then returns to the center position to complete the initialization process. (Note: if there is an entry for position preset 0, the corresponding position preset 0 will be called up after initialization.)

Features

- Maximum resolution of 1920 x 1080 (Full HD) at 60Hz.
- Supports a Panasonic's 1/2.7 inch, 2.07 million effective pixels high quality HD CMOS sensor.
- Uses a 72.5° wide-angle high-quality lens.
- Supports a 12x optical zoom, and up to 16x digital zoom.
- High SNR CMOS sensor combined with 2D & 3D noise reduction algorithm, effectively reducing noise even under low light conditions.
- Supports AAC audio encoding for better sound quality at a lower bandwidth.
- Designed with worm gear drive for reliable and accurate movement.
- May be remotely controlled via RS232 and IP.
- Works as a standalone device.

Specification

Camera	
Sensor	1/2.7 inch, CMOS, Effective Pixels: 2.07M
Scanning Mode	Progressive
Lens	12x, focal length of 3.5mm to 42.3mm, F-Stop of 1.8 to F2.8
Digital Zoom	16x
Minimal Illumination	0.5 Lux @ (F1.8, AGC ON)
Shutter	1/30s to 1/10000s
White Balance	Auto, Indoor, Outdoor, One Push, Manual
Backlight Compensation	Supported
Digital Noise Reduction	2D & 3D Digital Noise Reduction
Video S/N	≥55dB
Horizontal Angle of View	72.5° to 6.9°
Vertical Angle of View	44.8° to 3.9°
Horizontal Rotation Range	-170° to +170°
Vertical Rotation Range	-30° to +30°
Pan Speed Range	1.7° to 100°/s
Tilt Speed Range	0.7° to 28°/s
Horizontal & Vertical flip	Supported
Image Freezing	Supported
Number of Presets	255
Preset Accuracy	0.1°
IPC Features	
Video coding standard	H.265/H.264/MJPEG
Video Stream	First Stream, Second Stream
First Stream resolution	1920x1080,1280x720,1024x576,960x540,640x480,640x360
Second Stream resolution	1280x720,1024x576,720x576,720x408,640x360,480x270,320x240,320x180
Video Bit Rate	32Kbps to 20480Kbps
Bit Rate Types	Variable bit rate and Fixed bit rate

Frame Rate	1fps to 60fps
Audio encode standard	AAC
Audio Bit Rate	96Kbps, 128Kbps, 256Kbps
Support protocols	TCP/IP, HTTP, RTSP, RTMP, ONVIF, DHCP, Multicast, etc.
Input/Output Interface	
HD Output	One (1) HDMI 1.3
Network interface	One (1) RJ45: 10/100/1000M Adaptive Ethernet ports
Audio interface	1-ch 3.5mm audio interface, Line In
Communication interface	One (1) RS-232: 8pin Min DIN, Max Distance: 30m, Protocol: VISCA/Pelco-D/Pelco-P
Power jack	JEITA type (DC IN 12V)
Generic Specification	
Input Voltage	DC 12V
Current Consumption	1.0A (Max)
Operating Temperature	-10°C ~ 40°C (14°F ~ 104°F)
Storage Temperature	-40°C ~ 60°C (-40°F ~ 140°F)
Power Consumption	12W (Max)
MTBF	>30000h
Unit dimensions	6.65" x 5.59" x 6.46" (169mm x 142mm x 164mm)
Unit Weight	3.0lbs (1.35Kg)
Model	
Ordering Information	500791 HDMI/IP PTZ Camera

Main Unit Connections



1 RJ45S Ethernet interface (for video streaming and device control)

2 HDMI Out interface

3 2CH AUDIO LINE IN interface

4 RS232 interface for control

5 12VDC IN power interface

IR Handheld Remote Control

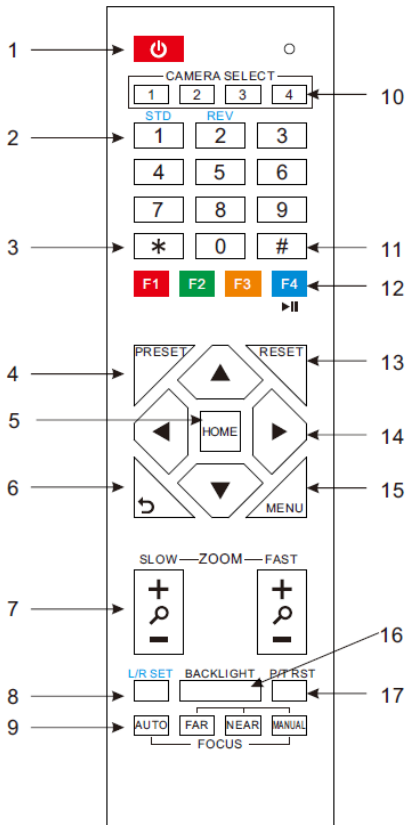

1. Standby Button

Pressing this button toggles between “standby” and “normal power On” mode. (standby mode is approximately half the power consumption of power On mode)

2. Numeric Position Buttons

To store or activate a preset position

3. * Button

Used in combination with other buttons

4. Preset Button

[PRESET] + Numeric key (0-9): Saves a preset position to a numeric key

5. Pan-Tilt Home Button

Pressing this button sets the camera to the Pan/Tilt center (home) position

6. Back/Return button

Press this button returns you to the previous (higher) OSD (On Screen Display) menu.

7. Zoom Buttons

Slow Zoom: Zoom In [+] or Out [-] slowly

Fast Zoom: Zoom In [+] or Out [-] quickly

8. Pan-Tilt L/R set

Press the L/R Set button and either the “1” key or “2” key to set the camera direction of the Pan-Tilt motion.

L/R Set +1 [STD]: sets the Pan-Tilt motion to the default left/right direction

L/R Set +2 [REV]: sets the Pan-Tilt motion to the reverse right/left direction

9. Focus Buttons

Used for focus adjustment.

Press [AUTO] to adjust the focuses on the center object automatically.

Press [MANUAL] to adjust the focus on the center of the object manually by using the

[Far] button (to focus on far objects) and [NEAR] button (to focus on near objects)

10. Camera Select Buttons

Press the button corresponding to the camera you want to operate with the remote controller.

11. # Button

Used in combination with other buttons

12. Set Camera IR Address Buttons

To set to Address1, press on [*]+[#]+[F1] buttons

To set to Address2, press on [*]+[#]+[F2] buttons

To set to Address3, press on [*]+[#]+[F3] buttons

To set to Address4, press on [*]+[#]+[F4] buttons

13. Reset (Clear Preset) Button

Clear preset: Erase a preset position

Press [RESET] + Numeric button (0-9)

Or: [*]+[#]+[RESET]: To erase all the presets

14. Pan/Tilt Control Buttons

Press arrow buttons to perform panning (Left & Right) and tilting (Up & Down). Press [HOME] button to return the camera to the center (home) position

15. MENU

MENU: enter or exit OSD MENU

16. BLC (Backlight Compensation) Button

BLC ON/OFF: Press this button to enable the backlight compensation. Press it again to disable the backlight compensation. (NOTE: Effective only in auto exposure mode)

Note: If there is a light behind the subject, the subject will become dark. In this case, press the backlight ON / OFF button. To cancel this function, press the backlight ON / OFF button again.

17. P/T RST

Press this button to automatically re-calibrate pan and tilt.

18. Screen capture function

Manual screen capture: To activate the screen capture function, press the [F4] key on the remote control, a "Freeze" message will be displayed in the upper left corner of the screen, after 5 seconds, this message will disappear. If you want to manually cancel the screen capture function, press the [F4] key on the remote control, an "Unfreeze" message will be displayed in the upper left corner of the screen, after 5 seconds, this message will disappear.

Recalling the Preset with image Freeze: go to OSD main menu, then to the P/T/Z submenu, and then set "Freeze Image" to ON. Once this feature is enabled, the screen will freeze before going to a Preset. This can be useful when recalling presets to hide camera shake from viewers.

19. Shortcut Set

[*]+[#]+[1]: OSD menu default English

[*]+[#]+[3]: OSD menu default Chinese

[*]+[#]+[4]: Default IP address

[*]+[#]+[5]: Save OSD

[*]+[#]+[6]: Quickly recover the default settings

[*]+[#]+[8]: Display the camera version

[*]+[#]+[9]: Quickly set up inversion

RS-232 Interface Pinout

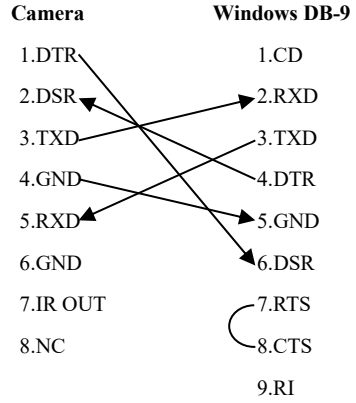
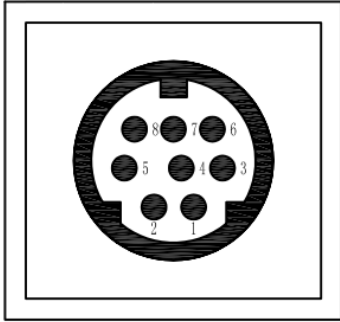

No.	Function
1	DTR
2	DSR
3	TXD
4	GND
5	RXD
6	GND
7	IR OUT
8	NC

Camera	Mini DIN
1.DTR	1.DTR
2.DSR	2.DSR
3.TXD	3.TXD
4.GND	4.GND
5.RXD	5.RXD
6.GND	6.GND
7.IR OUT	7.NC
8.NC	8.NC

Serial Communication Control

In default mode, the camera can connect to a VISCA controller with an RS232C serial interface.

➤ RS232 Communication Settings:

The camera may be controlled via RS232 when set to the following parameters:

Baud rate: 2400, 4800, or 9600 bit/s.

Start bit: 1 bit.

Data bits: 8 bits.

Stop bit: 1bit.

Parity bit: none.

When the camera is turned on, the Pan-Tilt function will move to the maximum top-right position and then will return to the center (Home) position to complete an initialization process. (Note: If the position preset 0 has been stored, the position preset 0 will be called up after the initialization step). After the initialization process users can control the camera via the control commands in the below command list.

PTZ over TCP/UDP Control

The camera supports a TCP server via port number 5678. After the client establishes a TCP connection with the server, the client may send PTZ control commands to the server to be executed.

A UDP server is also available via port number 1259. Once the client establishes a UDP connection with the server, the client may send PTZ control commands to the server to be executed.

Command List

The Visca and Pelco-D command List may be found in the Appendix.

Menu Settings

1.MENU

Press the [MENU] button to display the main menu on the screen. Use the arrow buttons to move the cursor to the item to be set. Press the [HOME] button (works similar to an Enter key) to enter the corresponding sub-menu.

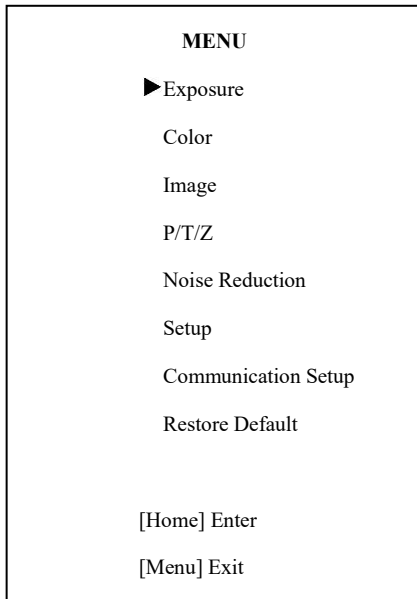

2. EXPOSURE

Move the cursor to the Exposure submenu in the main menu and press the [home] button, the EXPOSURE submenu will appear as shown in the following figure.

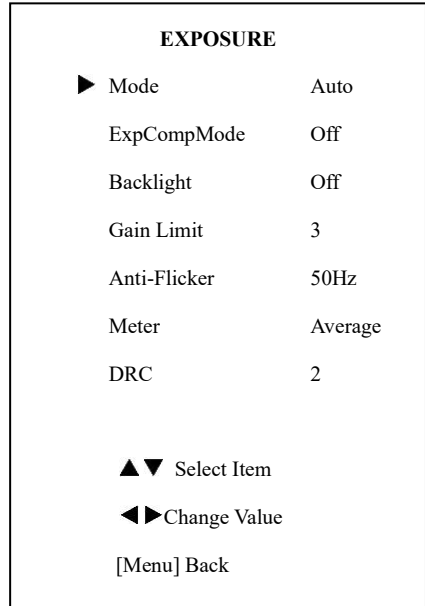

Mode: Exposure mode. Optional settings: Auto, Manual, SAE, AAE, Bright

ExpCompMode: Exposure compensation mode, Optional settings: On, Off (Effective only in Automode)

ExpComp: Exposure compensation value, Optional settings: -7 to +7 (Effective only in ExpCompMode = On)

Gain Limit: Maximum gain limit. Optional settings: 0 to 15 (Effective only in Auto, AAE, and Bright mode)

Backlight: Set the backlight compensation, Optional settings: On, Off (Effective only in Auto mode)

Meter: Optional settings: Average, Center, Bottom, Top

DRC: DRC strength, Optional settings: 0 to 8.

Bright: Intensity control, Optional settings: 00 to 17. (Effective only in Bright mode)

Anti-Flicker: Set Anti-flicker. Optional settings: Off, 50Hz, 60Hz (Effective only in Auto and Bright mode)

Iris: Aperture value. Optional settings: F1.8, F2.0,F2.4,F2.8,F3.4,F4.0,F4.8,F5.6,F6.8,F8.0,F9.6 ,F11.0,Close (Effective only in Manual, AAE mode)

Shutt: Shutter value. Optional settings: 1/30,1/60,1/90,1/100,1/125,1/180,1/250,1/350,1/500,1/725,1/1000,1/1500,1/2000,1/3000,1/4000,1/6000,1/10000 (Effective only in Manual, SAE mode)

settings: Auto, 3000K/Indoor, 4000K,5000K/Outdoor, 6500K-1,6500K-2,6500K-3, One Push, Manual

RG: Red gain. Optional settings: 0 to 255 (Effective only in Manual mode)

BG: Blue gain. Optional settings: 0 to 255 (Effective only in Manual mode)

RG: Tuning: Red gain fine-tuning, Optional settings: -10 to +10 (Effective only in AWBsens is Low)

BG: Tuning: Blue gain fine-tuning, Optional settings: -10 to +10 (Effective only in AWBsens is Low)

Sat.: Saturation. Optional settings: 60% to 200%.

Hue: Chroma adjustment, Optional settings: 0 to 14.

AWBsens: The white balance sensitivity, Optional settings: Normal, High, Low.

3. COLOR

Move the cursor to the Color submenu in the main menu and press the [home] button. The COLOR submenu will appear as shown in the following figure.

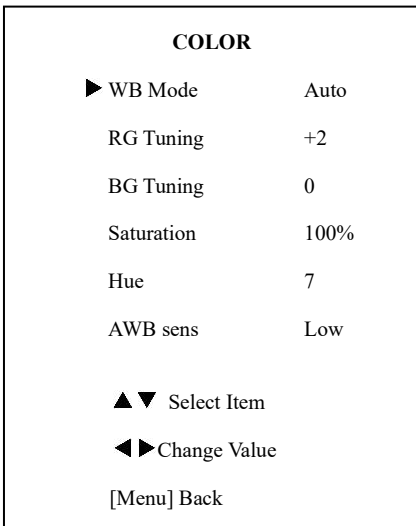

4. IMAGE

Move the cursor to the Image submenu in the main menu and press the [home] button. The IMAGE submenu will appear as shown in the following figure.

WB-Mode: White balance mode. Optional

IMAGE

▶ Luminance	7
Contrast	7
Sharpness	2
Flip-H	Off
Flip-V	Off
B&W-Mode	Off
Gamma	Default
Style	Clarity

▲▼ Select Item

◀▶ Change Value

[Menu] Back

Luminance: Brightness adjustment. Optional settings: 0 to 14

Contrast: Contrast adjustment. Optional settings: 0 to 14

Sharpness: Sharpness adjustment. Optional settings: Auto, 0 to 15

Flip-H: Image flipped horizontally. Optional settings: On, Off.

Flip-V: Image Flip Vertical. Optional settings: On, Off.

B&W-Mode: Set to B&W Image. Optional settings: On, Off.

Gamma: Optional settings: Default, 0.45, 0.5, 0.56, 0.63.

Style: Optional settings: Norm, Clarity, Bright, Soft, 5S.

5.P/T/Z

Move the cursor to the P/T/Z submenu in the main menu and press the [home] button. The P/T/Z submenu will appear as shown in the following figure.

P/T/Z

▶ SpeedByZoom	On
AF-Zone	Center
AF-Sense	High
L/R Set	STD
Display Info	On
Image Freeze	Off
Digital Zoom	Off

▲▼ Select Item

◀▶ Change Value

[Menu] Back

SpeedByZoom: The depth of field scale switch, Optional settings: On, Off

AF-Zone: Interested in focusing area, Optional settings: Top, Center, Bottom

AF-Sense: Automatic focusing sensitivity, Optional settings: Low, Normal, High

L/R Set: Optional settings: STD, REV

Image Freeze: Optional settings: On, Off

Display Info: Optional settings: On, Off

Digital Zoom: Optional settings: Off, 2x, 4x, 8x,

6. NOISE REDUCTION

Move the cursor to the Noise Reduction submenu in the main menu and press the [home] button. The NOISE REDUCTION submenu will appear as shown in the following figure.

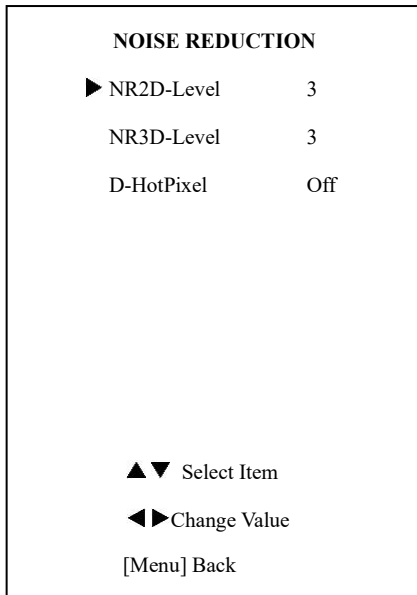

NR2D-Level: 2D noise reduction. Optional settings: Off, Auto, 1 to 5

NR3D-Level: 3D noise reduction. Optional settings: Off, 1 to 8

D-HotPixel: Dynamic bad points, Optional settings: Off, 1 to 5

7. SETUP

Move the cursor to the Setup submenu in the main menu and press the [home] button. The SETUP submenu will appear as shown in the following figure.

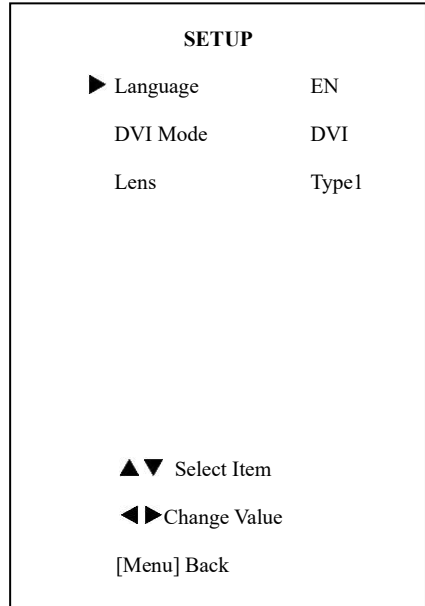

Language: language selection, Optional settings: EN (English), Chinese, Russian

DVI Mode: Optional settings: DVI, HDMI

Lens: Lens type. Optional settings: Type1, Type2

8. COMMUNICATION SETUP

Move the cursor to the Communication Setup submenu in the main menu and press the [home] button. The COMMUNICATION SETUP submenu will appear as shown in the following figure.

COMMUNICATION SETUP

▶ Protocol	VISCA
V_Address	1
V_AddrFix	Off
Net Mode	Serial
Baudrate	9600

▲▼ Select Item

◀▶ Change Value

[Menu] Back

Protocol: Control protocol type. Optional settings:

AUTO, VISCA, PELCO-D, PELCO-P

V_Address: Protocol address, To be decided according to the agreement, AUTO, VISCA protocol Optional settings: 1 to 7

P_D_Address: PELCO-D protocol Optional settings: 0 to 254

P_P_Address: PELCO-P protocol Optional settings: 0 to 31

V_AddrFix: Allows you to scan through the serial port infrared switch setting, Optional settings: On, Off

(When set to On, the 88 30 01 FF Command is useless)

Net Mode: Set the serial port control or networking, Optional settings: Serial, Paral

Baudrate: Serial port baud rate. Optional settings:

2400, 4800, and 9600

9.RESTORE DEFAULT

Move the cursor to the Restore Default submenu in the main menu and press the [home] button. The RESTORE DEFAULT submenu will appear as shown in the following figure.

RESTORE DEFAULT

▶Restore? No

◀▶Change Value

[Home] OK

[Menu] Back

Restore: Confirm restore factory settings.

Optional settings: Yes, No

Note: Press the [HOME] button to confirm, and ALL parameters will be restored to their factory default setting, Include IR Remote address and VISICA Address

Save: Save Options. Optional settings: Yes, No

Network Function

1 Operating Environment

Operating System: Windows 2000/2003/XP/vista/7/8/10

Network Protocol: TCP/IP

Client PC: P4/128MRAM/40GHD and higher, supporting scaled graphics card with DirectX 8.0 and higher.

2 Equipment Installation

- 1) Connect the network port on the camera to your network or directly to your PC via an Ethernet cable.
- 2) Plug in the 12VDC power supply to turn on the camera.
- 3) The orange LED on the network port will light up and the green LED will flash to indicate that the physical network connection is complete.

3 Internet Connection

The below shows the possible connection methods described above between the camera network port and computer as in figure 1.1, or to the network as in figure 1.2 below:



Figure 1.1 Direct connect to PC

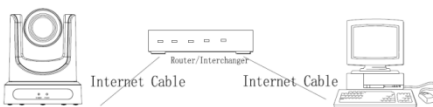

Figure 1.2 Connect via router/modem

4 IP camera control via LAN

4.1 Setup IP address

The camera default IP address is: 192.168.100.88, If the camera IP address is unknown, it may be found as follows:

Method 1: press * and then # and then 4 on remote controller (one key after another), the camera IP address will be shown on an attached HDMI display.

Method 2: connect the camera directly to a PC via an Ethernet cable, and use the "upgrade_En.exe" application to search for the IP address



The IP address may be changed in the following two ways:

Method 1: On web interface, go to "Network" => Change IP => make your change => Click "Apply" => Restart the camera.

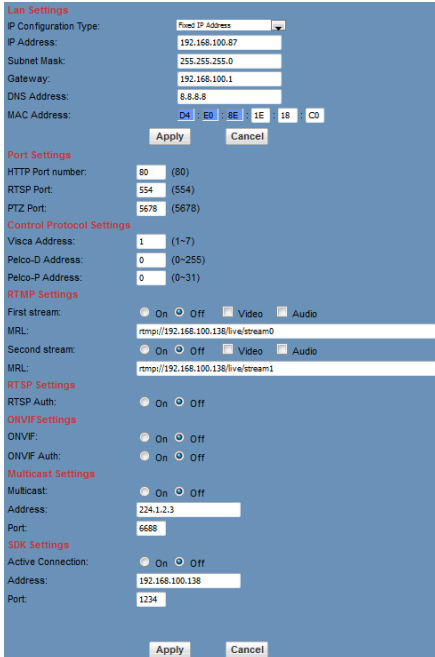

192.168.100.88, then login with the username: "admin", and password: "admin".

4.2 Access IP Camera Web Interface

In your favorite browser input `http://192.168.100.88` (note that the Microsoft browser may have a lower latency). The login window will pop up, then input the username: "admin", and password: "admin", shown as below:



Method 2: Open "upgrade_En.exe" application on your PC, and go to Config tab to change the IP address and then click "Set". Then restart the camera.

After login a window similar to the below will be shown:

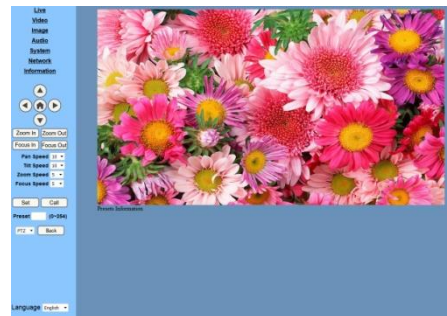
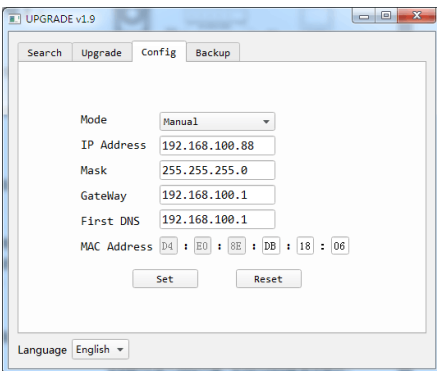

 **NOTE!**

 **NOTE!**

IP the camera has the default IP address of _____ at:

<http://www.videolan.org/vlc/download> and Install the VLC player software. After installation, login again to obtain the above screen:

5 IP Camera accessed/controlled by WAN (internet)

5.1 Setup IP Camera for access/control via dynamic DNS

There are two dynamic DNS available:

Dyndns.org,
3322.org

Router Port Mapping:

Using a router such as the Tenda router, enter the Router Home Page (interface page), select "Advanced" => "Virtual Server", and add a new port number in "Ext Port", add a new port number in "Int port", set camera IP address to an "Internal IP", then select "Save", as shown below:

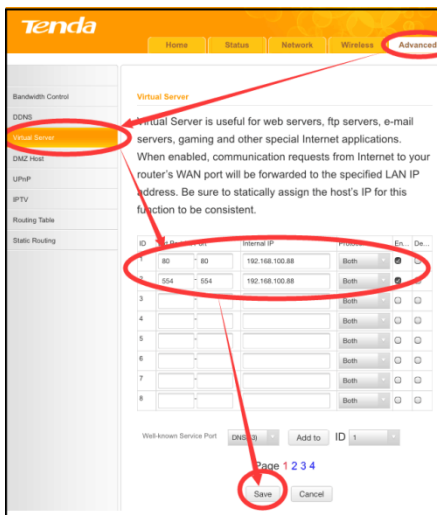

5.2 Dynamic DNS camera access

Set the domain name in the camera, setup the

parameter, then the dynamic DNS can be used to access the camera. Access link: <http://hostname :port number> For example, setup host computer name: youdomain.f3322.org, camera port number: 554, Access link should be: <http://youdomain.3322.org:554>.



NOTE!

If the camera port default is 80, then it is not necessary to input the port number, in this case only the host name is required to access the camera.

5.3 VLC stream media player monitoring, see VLC media server procedure

Open VLC media player, click "Media" => "Open Network Steam", or click "Ctrl+N"; as shown below:

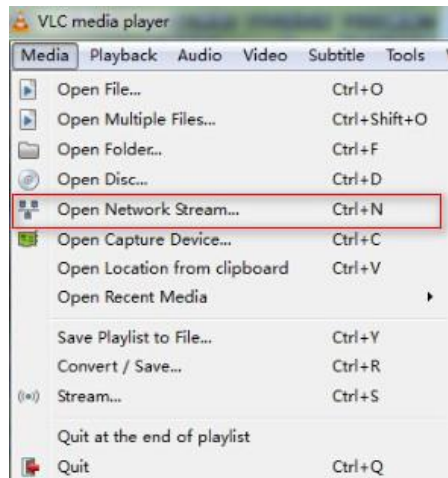

Input URL address:

rtp://ip: port number/1 (First stream);

rtp://ip: port number/2 (Second stream).



NOTE!

The RTSP default port number is: 554.

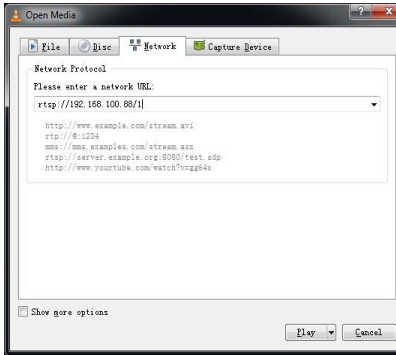

6 IP Camera parameter setup

6.1 Homepage introduction

Menu



All pages include 2 menu bars:

Real time monitoring: displaying video image

Parameter setup: with function buttons

A. Video viewing window

The Video viewing window must be set to the same

camera video resolution. The larger the resolution, the larger the playing window. Double click the viewing window, will switch to full-screen, and double clicking again, will return to the initialized size.

The Status bar in the viewing window will be as shown below:



- 1) Video playback pause button: toggles between video pause and play.
- 2) Audio control buttons: can control the volume and mute/unmute.
- 3) Full screen switch with toggle between normal and full screen mode.

B. PTZ Setup

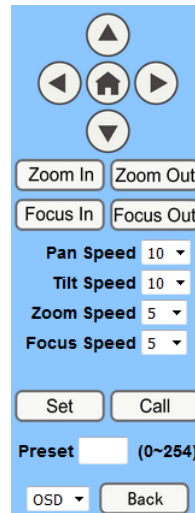

- 1) PTZ direction control: Supports up, down, left, right, center (home) Pan/Tilt.
- 2) Pan/Tilt Rate: Vertical speed can be set

between 1 to 24, while horizontal speed can be set between 1 to 20.

3) Select the corresponding speed above and click on the direction keys to move in the Pan/Tilt direction at the newly set speed.

4) Zoom In/Zoom out: for zooming in or zooming out.

Focus In/Focus Out: for focusing on near or distant objects.

5) Set/Call: When the PTZ is at the desired position, you can save this as a preset and recall it. There are up to 255 different presets (from 0 to 254) as shown below.

Method 1: Type a number into the Preset box.



Method 2: Type a preset name into the name field.

Presets Information		
No.	Name	
1	<input type="text"/>	Set
2	<input type="text"/>	Set
3	<input type="text"/>	Set
4	<input type="text"/>	Set
5	<input type="text"/>	Set
6	<input type="text"/>	Set
7	<input type="text"/>	Set
8	<input type="text"/>	Set
9	<input type="text"/>	Set

Then click the "Set" button to save. To recall a preset position, click the "Call" button, or click a "No." on the Presets Information window above, and the camera will move to the preset position.



6) PTZ / MENU, MENU: system in menu

mode, OSD menu will display in the upper corner of the image page. PTZ direction control box: up/down button selects different submenus. The home button enters a submenu, and the left/right buttons modify the submenu. After the menu has been modified, select PTZ. If in the main menu, save the settings to exit automatically. Otherwise, return to the previous menu with Back button (this is effective only in a submenu).

PTZ: system in PTZ mode.

C. Language selection

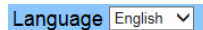

Options: English/Chinese/Russian

6.2 Media

Video Setup, please click "Video"

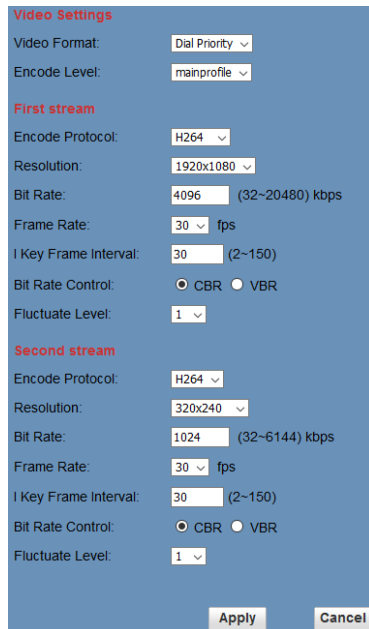

1) Video format

Supports: 50Hz (PAL), 60Hz (NTSC) and Dial priority.

2) Encode Protocol

Supports: H.264, H.265 and MJPEG.

3) Encode Level

Supports: baseline, main profile, high profile.

4) Resolution

First stream supports: 1920x1080, 1280x720, 1024x576, 960x540, 640x480, and 640x360

Second stream supports: 1280x720, 1024x576, 720x576, 720x408, 640x360, 480x270, 320x240, and 320x180. The larger the resolution, the clearer the image will be, but more network bandwidth will be required.

5) Bit Rate

The user can set the bit flow/stream, and normally the larger the bit flow, the clearer the image will be.

The bit rate setting must take into account the network bandwidth. If the network bandwidth is low and the bit rate is too high, then this may negatively affect the video transmission quality.

6) Frame rate

The user can specify the frame rate, generally a higher frame rate will produce smoother video, while a lower frame rate may produce choppy video.

7) I key frame interval:

Set the interval between 2 I-frames, the larger the interval, the response will be slower on the viewing window.

8) Bit Rate control

Code stream control types:

Constant bit rate: video encoder will be coding according to a preset rate

Variable bit rate: video encoder will adjust the rate to obtain the best image quality.

9) Fluctuate level

Restrains the fluctuation magnitude of the variable rate, grade 1 to 6.

6.3 Image Setup (click "Image")



1) Brightness

Image brightness range is from 0 to 14. The slider control shows the corresponding numerical value on the right. Default is 7.

2) Saturation

Image saturation range is from 0 to 14. The slider control shows the corresponding numerical value on the right. Default is 4.

3) Contrast

Image contrast range is from 0 to 14. The slider control shows the corresponding numerical value on the right. Default is 7.

4) Sharpness

Image sharpness range is from 0 to 15. The slider control shows the corresponding numerical value on the right. Default is 2.

5) Hue

Image hue range is from 0 to 14. The slider control shows the corresponding numerical value on the right. Default is 7.

6) Flip & Mirror

Enable the Flip button to flip the image horizontally.

Enable the Mirror button to flip the image vertically (from right to left). Default mode is disabled (buttons not selected).

7) Apply/Cancel/Default Button

After adjusting parameters, press the "Apply" button to save, press the "Cancel" button to cancel any changes, and press the "Default" button to recall the default settings.

6.4 Audio Setup (click "Audio")

Audio Settings

Audio Type: AAC ▾

Sample Rate: 48K ▾

Bit Rate: 96K ▾

Input Type: Line in ▾

Input Vol L: 8 (-97~30) db

Input Vol R: 8 (-97~30) db

ADTS Options: Off ▾

Apply Cancel

1) Audio Type

Audio type AAC

2) Sample rate

Sample rate: 44.1K or 48K.

3) Bit rate

Bit rate: 96K, 128K, or 256K.

4) Input Type

Line In only.

5) Input VolL

Set volume of the left channel.

6) Input VolR

Set volume of the right channel.

7) ADTS Options

Optional settings: On or Off

8) Apply/Cancel Button

Press the "Apply" button to save changes, or press the "Cancel" button to cancel changes.

6.5 System Setting (click "System")

1) Work Mode

Work Mode RTSP

2) Reboot

Click the "Reboot" button for system restart.

3) User and password

The user can modify the password (characters must be letters and numbers only).

4) Apply/Cancel Button

Modify password and click the "Apply" button to save the new password, or press the "Cancel" button to cancel password change.

6.6 Network Setting (click "Network")

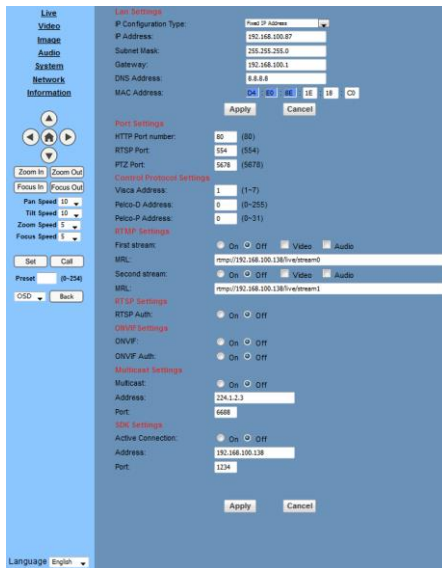

1) Lan Settings

The Default IP address is 192.168.100.88. The MAC address can be modified.

2) Port Settings

A. HTTP Port

The IP address identifies the network device, the device can run multiple web applications, with each network program using a network port to transmit data, so data transmission can be carried out from port to port. Port setting is used to set up the WEB SERVER program port to transmit. When doing port mapping, you need to be consistent with the port number (default port: 80)

B. RTSP Port

The camera supports the RTSP protocol for network streaming, and can make use of the VLC application or similar tools to broadcast.

C. PTZ Port

Supports PTZ protocol, the default port is: 5678.

3) Control Protocol Setting

Setting camera control communication protocol, include Visca address, Pelco-D address, Pelco-P address.

4) RTMP Setting

Setting the camera network stream. The camera supports two streams, in the two stream selection control code with settings: "On", "Off", "Video", "Audio", etc.

5) RTSP Setting

Setting the camera network rtsp protocol: "On" or "Off".

6) ONVIF Setting

Setting the ONVIF protocol and ONVIF authorization: "On" or "Off".

7) Multicast Setting

Setting multicast: "On" or "Off". The multicast default address is: 224.1.2.3, and the port default is: 6688.

8) Apply/Cancel Button

Modify the network parameters and press the "Apply" button to save the changes, or press the "Cancel" button to cancel the changes.

7 Device Information (click "information")

Shows the current device information, as shown below.

Information

Device ID:	HD Camera
Software Version:	SOC v7.2.08 - ARM v6.2.49S
Device Type:	F4.V
Webware Version:	v1.4.4

7 Downloading firmware updates

Visit the MuxLab website at www.muxlab.com for any updated firmware for this camera (model 500791), if any.

Maintenance and Troubleshooting

Camera Maintenance

- If camera will not be used for a long time, please turn off the power, by disconnecting the power supply from the AC outlet.
- Use a soft cloth or tissue to clean the camera cover.
- Please use an appropriate soft dry cloth to clean the lens. If the camera is very dirty, clean it with a diluted neutral detergent. Do not use any type of solvents, which can damage the lens surface.

Avoid the Following

- Do not direct extremely bright objects for a long period of time at the camera lens, such as sunlight, very bright light sources, etc.
- Do not operate this device in unstable lighting conditions, otherwise the image may flicker.
- Do not operate this device close to powerful electromagnetic radiation, such as TVs, radio transmitters, etc.

Troubleshooting

Image Issues

- No image
 1. Check whether the power cord is connected, voltage is OK, and POWER LED is ON.
 2. Verify that the camera can successfully complete the self-test after startup.
 3. Check that the video cable is not damaged and is connected correctly.
- Abnormal video image

Check that the video cable is not damaged and is connected correctly.
- Image dithering even at widest zoom position
 1. Check whether camera is fixed correctly.
 2. Make sure that there is no nearby vibrating machinery.
- No video image shown in the browser

When the camera is accessed for the first time via a web browser, the user may need to install a plug-in. Also if using this camera for the first time over the internet, the user may need to install a video player software (such as VLC). Please go to the VLC website: <http://www.videolan.org/vlc/download> and install the VLC Player. After installation, login again, and the video image should be available.

- Unable to access IP Camera by a browser.

1. Access the network with a PC to test whether the network works, to eliminate the possibility of a faulty cable, or network failure caused by a PC virus. Ping the PC to confirm proper operation.
 2. Disconnect the IP Camera from the network, and connect the IP Camera to the PC and verify or reset the camera IP address.
 3. Check the server's IP address and subnet mask and gateway address.
 4. MAC addresses conflict.
 5. Web port is occupied by other devices.
- When modifying the IP address in an incorrect manner, this may cause the wrong IP address to be created, or if the user simply forgets his password, press the IR remote controller "[*]+[#]+[Manual]" to restore the default value (Default IP: 192.168.100.88, Default username: admin , and Default password: admin)

Control

- IR remote controller cannot control the camera
 1. Change the battery
 2. Check the camera's operating mode.
 3. Check that the IR address on the IR Remote Control is set correctly.

- Serial communication cannot control the camera
 1. Check the camera's operating mode.
 2. Check that the RS232 cable is connected correctly.
 3. Check the RS232 port settings.

Appendix – Visca and Pelco-D Comment List

VISCA Command List

Part 1: Camera-Issued Messages

ACK/Completion Message			
Command	Function	Command Packet	Comments
ACK/Completion Messages	ACK	z0 4y FF (y: Socket No.)	Returned when the command is accepted.
	Completion	z0 5y FF (y: Socket No.)	Returned when the command has been executed.

z = Camera Address + 8

Error Messages			
Command	Function	Command Packet	Comments
Error Messages	Syntax Error	z0 60 02 FF	Returned when the command format is different or when a command with illegal command parameters is accepted.
	Command Buffer Full	z0 60 03 FF	Indicates that two sockets are already being used (executing two commands) and the command could not be accepted when received.
	Command Canceled	z0 6y 04 FF (y: Socket No.)	Returned when a command which is being executed in a socket specified by the cancel command is canceled. The completion message for the command is not returned.
	No Socket	z0 6y 05 FF (y: Socket No.)	Returned when no command is executed in a socket specified by the cancel command, or when an invalid socket number is specified.
	Command Not Executable	z0 6y 41 FF (y: Execution command Socket No. Inquiry command: 0)	Returned when a command cannot be executed due to current conditions. For example, when commands controlling the focus manually are received during auto focus.

Part 2: Camera Control Commands

Command	Function	Command Packet	Comments	
AddressSet	Broadcast	88 30 01 FF	Address setting	
IF_Clear	Broadcast	88 01 00 01 FF	I/F Clear	
CAM_Power	On	8x 01 04 00 02 FF	Power ON/OFF	
	Off	8x 01 04 00 03 FF		
CAM_Zoom	Stop	8x 01 04 07 00 FF	p = 0(low) - 7(high) pqrs: Zoom Position	
	Tele(Standard)	8x 01 04 07 02 FF		
	Wide(Standard)	8x 01 04 07 03 FF		
	Tele(Variable)	8x 01 04 07 2p FF		
	Wide(Variable)	8x 01 04 07 3p FF		
	Direct	8x 01 04 47 0p 0q 0r 0s FF		
CAM_Focus	Stop	8x 01 04 08 00 FF	p = 0(low) - 7(high) pqrs: Focus Position	
	Far(Standard)	8x 01 04 08 02 FF		
	Near(Standard)	8x 01 04 08 03 FF		
	Far(Variable)	8x 01 04 08 2p FF		
	Near(Variable)	8x 01 04 08 3p FF		
	Direct	8x 01 04 48 0p 0q 0r 0s FF		
	Auto Focus	8x 01 04 38 02 FF		AF On/Off
	Manual Focus	8x 01 04 38 03 FF		
Auto/Manual	8x 01 04 38 10 FF			
CAM_ZoomFocus	Direct	8x 01 04 47 0p 0q 0r 0s	pqrs: Zoom Position tuvw: Focus Position	
		0t 0u 0v 0w FF		
CAM_WB	Auto	8x 01 04 35 00 FF	Normal Auto	
	Indoor mode	8x 01 04 35 01 FF	Indoor mode	
	Outdoor mode	8x 01 04 35 02 FF	Outdoor mode	
	OnePush mode	8x 01 04 35 03 FF	One Push WB mode	
	Manual	8x 01 04 35 05 FF	Manual Control mode	
	OnePush trigger	8x 01 04 10 05 FF	One Push WB Trigger	
CAM_RGain	Reset	8x 01 04 03 00 FF	Manual Control of R Gain	
	Up	8x 01 04 03 02 FF		
	Down	8x 01 04 03 03 FF		
	Direct	8x 01 04 43 00 00 0p 0q FF	pq: R Gain	
CAM_Bgain	Reset	8x 01 04 04 00 FF	Manual Control of B Gain	
	Up	8x 01 04 04 02 FF		
	Down	8x 01 04 04 03 FF		
	Direct	8x 01 04 44 00 00 0p 0q FF	pq: B Gain	

CAM_AE	Full Auto	8x 01 04 39 00 FF	Automatic Exposure mode
	Manual	8x 01 04 39 03 FF	Manual Control mode
	Shutter priority	8x 01 04 39 0A FF	Shutter Priority Automatic Exposure mode
	Iris priority	8x 01 04 39 0B FF	Iris Priority Automatic Exposure mode
	Bright	8x 01 04 39 0D FF	Bright Mode(Manual control)
CAM_SlowShutter	AutoSlowShutterLimit	8x 01 04 2A 0p 00 FF	
CAM_Iris	Reset	8x 01 04 0B 00 FF	Iris Setting
	Up	8x 01 04 0B 02 FF	
	Down	8x 01 04 0B 03 FF	
	Direct	8x 01 04 4B 00 00 0p 0q FF	pq: Iris Position
CAM_Gain	Reset	8x 01 04 0C 00 FF	Gain Setting
	Up	8x 01 04 0C 02 FF	
	Down	8x 01 04 0C 03 FF	
	Direct	8x 01 04 0C 00 00 0p 0q FF	pq: Gain Position
	Gain Limit	8x 01 04 2C 0p FF	p: Gain Position
CAM_Bright	Reset	8x 01 04 0D 00 FF	Bright Setting
	Up	8x 01 04 0D 02 FF	
	Down	8x 01 04 0D 03 FF	
	Direct	8x 01 04 0D 00 00 0p 0q FF	pq: Bright Position
CAM_ExpComp	On	8x 01 04 3E 02 FF	Exposure Compensation On/Off
	Off	8x 01 04 3E 03 FF	
	Reset	8x 01 04 0E 00 FF	Exposure Compensation Amount Setting
	Up	8x 01 04 0E 02 FF	
	Down	8x 01 04 0E 03 FF	
	Direct	8x 01 04 4E 00 00 0p 0q FF	pq: ExpComp Position
CAM_BackLight	On	8x 01 04 33 02 FF	Back Light Compensation On/Off
	Off	8x 01 04 33 03 FF	
CAM_NR(2D)Mode	Auto	8x 01 04 50 02 FF	ND2D Auto/Manual
	Manual	8x 01 04 50 03 FF	
CAM_NR(2D)Level	-	8x 01 04 53 0p FF	p: NR Setting (0: Off, level 1 to 5)
CAM_NR(3D)Level	-	8x 01 04 54 0p FF	p: NR Setting (0: Off, level 1 to 8)
CAM_Flicker	-	8x 01 04 23 0p FF	p: Flicker Settings (0: Off, 1: 50Hz, 2: 60Hz)
CAM_DHotPixel	-	8x 01 04 56 0p FF	p: Dynamic Hot Pixel Setting (0: Off, level 1 to 6)
CAM_ApertureMode(sharpness)	Auto	8x 01 04 05 02 FF	Sharpness Auto
	Manual	8x 01 04 05 02 FF	Sharpness Manual

CAM_Aperture(sharpness)	Reset	8x 01 04 02 00 FF	Aperture Control
	Up	8x 01 04 02 02 FF	
	Down	8x 01 04 02 03 FF	
	Direct	8x 01 04 42 00 00 0p 0q FF	pq: Aperture Gain
CAM_PictureEffect	Off	8x 01 04 63 00 FF	Picture Effect Setting
	B&W	8x 01 04 63 04 FF	
CAM_Memory	Reset	8x 01 04 3F 00 pp FF	pp: Memory Number(=0 to 127)
	Set	8x 01 04 3F 01 pp FF	
	Recall	8x 01 04 3F 02 pp FF	
CAM_LR_Reverse	On	8x 01 04 61 02 FF	Image Flip Horizontal On/Off
	Off	8x 01 04 61 03 FF	
CAM_PictureFlip	On	8x 01 04 66 02 FF	Image Flip Vertical On/Off
	Off	8x 01 04 66 03 FF	
CAM_RegisterValue	-	8x 01 04 24 mn 0p 0q FF	mm: Register No. (=00-7F) pp: Register Value (=00-7F)
CAM_ColorGain	Diret	8x 01 04 49 00 00 00 0p FF	p: Color Gain setting 0h (60%) to Eh (200%)
SYS_Menu	Off	8x 01 06 06 03 FF	Turns off the menu screen
Pan_tiltDrive	Up	8x 01 06 01 VV WW 03 01 FF	VV: Pan speed 0x01 (low speed) to 0x18 (high speed) WW: Tilt speed 0x01 (low speed) to 0x14 (high speed) YYYY: Pan Position ZZZZ: Tilt Position
	Down	8x 01 06 01 VV WW 03 02 FF	
	Left	8x 01 06 01 VV WW 01 03 FF	
	Right	8x 01 06 01 VV WW 02 03 FF	
	Upleft	8x 01 06 01 VV WW 01 01 FF	
	Upright	8x 01 06 01 VV WW 02 01 FF	
	DownLeft	8x 01 06 01 VV WW 01 02 FF	
	DownRight	8x 01 06 01 VV WW 02 02 FF	
	Stop	8x 01 06 01 VV WW 03 03 FF	
	AbsolutePosition	8x 01 06 02 VV WW 0Y 0Y 0Y 0Y 0Z 0Z 0Z 0Z FF	
	RelativePosition	8x 01 06 03 VV WW 0Y 0Y 0Y 0Y 0Z 0Z 0Z 0Z FF	
	Home	8x 01 06 04 FF	
Reset	8x 01 06 05 FF		
Pan_tiltLimitSet	LimitSet	8x 01 06 07 00 0W 0Y 0Y 0Y 0Y 0Z 0Z 0Z 0Z FF	W: 1 UpRight 0: DownLeft YYYY: Pan Limit Position ZZZZ: Tilt Position
	LimitClear	8x 01 06 07 01 0W 07 0F 0F 0F 07 0F 0F 0F FF	
CAM_AFSensitivity	High	8x 01 04 58 01 FF	AF Sensitivity High/Normal/Low
	Normal	8x 01 04 58 02 FF	

	Low	8x 01 04 58 03 FF	
CAM_SettingReset	Reset	8x 01 04 A0 10 FF	Reset Factory Setting
CAM_Brightness	Direct	8x 01 04 A1 00 00 0p 0q FF	pq: Brightness Position
CAM_Contrast	Direct	8x 01 04 A2 00 00 0p 0q FF	pq: Contrast Position
CAM_Flip	Off	8x 01 04 A4 00 FF	Single Command For Video Flip
	Flip-H	8x 01 04 A4 01 FF	
	Flip-V	8x 01 04 A4 02 FF	
	Flip-HV	8x 01 04 A4 03 FF	
CAM_SettingSave	Save	8x 01 04 A5 10 FF	Save Current Setting
CAM_Iridix	Direct	8x 01 04 A7 00 00 0p 0q FF	pq: Iridix Position
CAM_AWBSensitivity	High	8x 01 04 A9 00 FF	High
	Normal	8x 01 04 A9 01 FF	Normal
	Low	8x 01 04 A9 02 FF	Low
CAM_AFZone	Top	8x 01 04 AA 00 FF	AF Zone weight select
	Center	8x 01 04 AA 01 FF	
	Bottom	8x 01 04 AA 02 FF	
CAM_ColorHue	Direct	8x 01 04 4F 00 00 00 0p FF	p: Color Hue setting 0h (- 14 degrees) to Eh (+14 degrees)

Part 3: Query Commands

Inquiry Command List			
Command	Command packed	Inquiry Packet	Comments
CAM_PowerInq	8x 09 04 00 FF	y0 50 02 FF	On
		y0 50 03 FF	Off(Standby)
		y0 50 04 FF	Internal power circuit error
CAM_ZoomPosInq	8x 09 04 47 FF	y0 50 0p 0q 0r 0s FF	pqrs: Zoom Position
CAM_FocusAFModeInq	8x 09 04 38 FF	y0 50 02 FF	Auto Focus
		y0 50 03 FF	Manual Focus
CAM_FocusPosInq	8x 09 04 48 FF	y0 50 0p 0q 0r 0s FF	pqrs: Focus Position
CAM_WBModeInq	8x 09 04 35 FF	y0 50 00 FF	Auto
		y0 50 01 FF	Indoor mode
		y0 50 02 FF	Outdoor mode
		y0 50 03 FF	OnePush mode
		y0 50 05 FF	Manual
CAM_RGainInq	8x 09 04 43 FF	y0 50 00 00 0p 0q FF	pq: R Gain
CAM_BGainInq	8x 09 04 44 FF	y0 50 00 00 0p 0q FF	pq: B Gain
CAM_AEModeInq	8x 09 04 39 FF	y0 50 00 FF	Full Auto
		y0 50 03 FF	Manual
		y0 50 0A FF	Shutter priority

		y0 50 0B FF	Iris priority
		y0 50 0D FF	Bright
CAM_ShutterPosInq	8x 09 04 4A FF	y0 50 00 00 0p 0q FF	pq: Shutter Position
CAM_IrisPosInq	8x 09 04 4B FF	y0 50 00 00 0p 0q FF	pq: Iris Position
CAM_BrightPosInq	8x 09 04 4D FF	y0 50 00 00 0p 0q FF	pq: Bright Position
CAM_ExpCompModeInq	8x 09 04 3E FF	y0 50 02 FF	On
		y0 50 03 FF	Off
CAM_ExpCompPositionInq	8x 09 04 4E FF	y0 50 00 00 0p 0q FF	pq: ExpComp Position
CAM_BacklightModeInq	8x 09 04 33 FF	y0 50 02 FF	On
		y0 50 03 FF	Off
CAM_Noise2DModeInq	8x 09 04 50 FF	y0 50 02 FF	Auto Noise 2D
		y0 50 03 FF	Manual Noise 3D
CAM_Noise2DLevel	8x 09 04 53 FF	y0 50 0p FF	Noise Reduction (2D) p: 0 to 5
CAM_Noise3DLevel	8x 09 04 54 FF	y0 50 0p FF	Noise Reduction (3D) p: 0 to 8
CAM_FlickerModeInq	8x 09 04 55 FF	y0 50 0p FF	p: Flicker Settings(0: OFF, 1: 50Hz, 2: 60Hz)
CAM_ApertureModeInq(Sharpness)	8x 09 04 05 FF	y0 50 02 FF	Auto Sharpness
		y0 50 03 FF	Manual Sharpness
CAM_ApertureInq(Sharpness)	8x 09 04 42 FF	y0 50 00 00 0p 0q FF	pq: Aperture Gain
CAM_PictureEffectModeInq	8x 09 04 63 FF	y0 50 02 FF	Off
		y0 50 04 FF	B&W
CAM_MemoryInq	8x 09 04 3F FF	y0 50 0p FF	p: Memory number last operated.
SYS_MenuModeInq	8x 09 06 06 FF	y0 50 02 FF	On
		y0 50 03 FF	Off
CAM_LR_ReverseInq	8x 09 04 61 FF	y0 50 02 FF	On
		y0 50 03 FF	Off
CAM_PictureFlipInq	8x 09 04 66 FF	y0 50 02 FF	On
		y0 50 03 FF	Off
CAM_RegisterValueInq	8x 09 04 24 mm FF	y0 50 0p 0p ff	mm: Register No. (00 to FF) pp: Register Value (00 to FF)
CAM_ColorGainInq	8x 09 04 49 FF	y0 50 00 00 00 0p FF	p: Color Gain setting 0h (60%) to Eh (200%)
CAM_IDInq	8x 09 04 22 FF	y0 50 0p 0q 0r 0s FF	pqrs: Camera ID

CAM_VersionInq	8x 09 00 02 FF	y0 50 ab cd mn pq rs tu vw FF	ab: Factory Code(00: VHD, 01:MR, 08:T) cd: Hardware Version mnpq: ARM Version rstu: FPGA Version vw: Camera model 01: C Type 02: M Type 03: S Type
VideoSystemInq	8x 09 06 23 FF	y0 50 00 FF	1920x1080i60
		y0 50 01 FF	1920x1080p30
		y0 50 02 FF	1280x720p60
		y0 50 04 FF	NTSC
		y0 50 05 FF	NTSC
		y0 50 06 FF	NTSC
		y0 50 07 FF	1920x1080p60
		y0 50 08 FF	1920x1080i50
		y0 50 09 FF	1920x1080p25
		y0 50 0A FF	1280x720p50
		y0 50 0C FF	PAL
		y0 50 0D FF	PAL
IR_Receive	8x 09 06 08 FF	y0 50 02 FF	On
		y0 50 03 FF	Off
Pan-tiltMaxSpeedInq	8x 09 06 11 FF	y0 50 ww zz FF	ww: Pan Max Speed zz: Tilt Max Speed
Pan-tiltPosInq	8x 09 06 12 FF	y0 50 0w 0w 0w 0w 0z 0z 0z 0z FF	www: Pan Position zzz: Tilt Position
CAM_TypeInq	8x 09 00 03 FF	y0 50 01 FF	C Type
		y0 50 02 FF	M Type
		y0 50 03 FF	S Type
CAM_DateInq	8x 09 00 04 FF	y0 50 0r ss uu vv ww 0D FF	Version dater: Big Version Numbers: Little Version Numberuuuu: Yearvv: Monthww: Day
CAM_ModelInq	8x 09 04 A6 FF	y0 50 00 FF	Mode0
		y0 50 02 FF	Mode2
CAM_GainLimitInq	8x 09 04 2C FF	y0 50 0q FF	p: Gain Limit
CAM_DHotPixellInq	8x 09 04 56 FF	y0 50 0q FF	p: Dynamic Hot Pixel Setting (0: Off, level 1 to 6)

CAM_AFSensitivityInq	8x 09 04 58 FF	y0 50 01 FF	High
		y0 50 02 FF	Normal
		y0 50 03 FF	Low
CAM_BrightnessInq	8x 09 04 A1 FF	y0 50 00 00 0p 0q FF	pq: Brightness Position
CAM_ContrastInq	8x 09 04 A2 FF	y0 50 00 00 0p 0q FF	pq: Contrast Position
CAM_FlipInq	8x 09 04 A4 FF	y0 50 00 FF	Off
		y0 50 01 FF	Flip-H
		y0 50 02 FF	Flip-V
		y0 50 03 FF	Flip-HV
CAM_IridixInq	8x 09 04 A7 FF	y0 50 00 00 0p 0q FF	pq: Iridix Position
CAM_AFZone	8x 09 04 AA FF	y0 50 00 FF	Top
		y0 50 01 FF	Center
		y0 50 02 FF	Bottom
CAM_ColorHueInq	8x 09 04 4F FF	y0 50 00 00 00 0p FF	p: Color Hue setting 0h (- 14 degrees) to Eh (+14 degrees)
CAM_AWBSensitivityInq	8x 09 04 A9 FF	y0 50 00 FF	High
		y0 50 01 FF	Normal
		y0 50 02 FF	Low

Block Inquiry Command List			
Command	Command packed	Inquiry Packet	Comments
CAM_LensBlockInq	8x 09 7E 7E 00 FF	y0 50 0u 0u 0u 0u 00 00 0v 0v 0v 0v 00 0w 00 FF	uuuu: Zoom Position vvvv: Focus Position w.bit0: Focus Mode 1: Auto 0: Manual
CAM_CameraBlockInq	8x 09 7E 7E 01 FF	y0 50 0p 0p 0q 0q 0r 0s tt 0u vv ww 00 xx 0z FF	pp: R_Gain qq: B_Gain r: WB Mode s: Aperture tt: AE Mode u.bit2: Back Light u.bit1: Exposure Comp. vv: Shutter Position ww: Iris Position xx: Bright Position z: Exposure Comp. Position

CAM_OtherBlockInq	8x 09 7E 7E 02 FF	y0 50 0p 0q 00 0r 00 00 00 00 00 00 00 00 00 FF	p.bit0: Power 1:On, 0:Off q.bit2: LR Reverse 1:On, 0:Off r.bit3~0: Picture Effect Mode
CAM_EnlargementBlockInq	8x 09 7E 7E 03 FF	y0 50 00 00 00 00 00 00 0p 0q rr 0s 0t 0u FF	p: AF sensitivity q.bit0: Picture flip(1:On, 0:Off) rr.bit6~3: Color Gain(0h(60%) to Eh(200%)) s: Flip(0: Off, 1:Flip-H, 2:Flip-V, 3:Flip-HV) t.bit2~0: NR2D Level u: Gain Limit

Note:

The [x] in the above table is the camera address, [y] = [x + 8].

Part 4: VISCA over IP Command List

Command	Function	Command Packet	Comments
CAM_Zoom	Stop	81 01 04 07 00 FF	
	Tele (Standard)	81 01 04 07 02 FF	
	Wide (Standard)	81 01 04 07 03 FF	
	Tele (Variable)	81 01 04 07 2p FF	p = (low) – 7 (high)
	Wide (Variable)	81 01 04 07 3p FF	
	Direct	81 01 04 47 p q r s FF	pqrs: Zoom Position
CAM_Focus	Stop	81 01 04 08 00 FF	
	Far (Standard)	81 01 04 08 02 FF	
	Near (Standard)	81 01 04 08 03 FF	
	Far (Variable)	81 01 04 08 2p FF	p = (low) – 7 (high)
	Near (Variable)	81 01 04 08 3p FF	
	Direct	81 01 04 48 p q r s FF	pqrs: Focus Position
	Auto Focus	81 01 04 38 02 FF	
	Manual Focus	81 01 04 38 03 FF	
	Auto/Manual Toggle	81 01 04 38 10 FF	
	Focus Lock	81 0a 04 68 02 FF	Prevents any other operation or command from adjusting the current focus state
Focus Unlock	81 0a 04 68 03 FF		
CAM_WB	Auto	81 01 04 35 00 FF	Normal Auto
	Indoor Mode	81 01 04 35 01 FF	Indoor Mode
	Outdoor Mode	81 01 04 35 02 FF	Outdoor Mode
	OnePush Mode	81 01 04 35 03 FF	OnePush WB Mode
	Manual	81 01 04 35 05 FF	Manual Control Mode
	OnePush Trigger	81 01 04 10 05 FF	OnePush WB Trigger
CAM_RGain	Reset	81 01 04 03 00 FF	Manual Control of R Gain
	Up	81 01 04 03 02 FF	
	Down	81 01 04 03 03 FF	
	Direct	81 01 04 43 00 00 p q FF	pq: R Gain
CAM_BGain	Reset	81 01 04 04 00 FF	Manual Control of B Gain
	Up	81 01 04 04 02 FF	
	Down	81 01 04 04 03 FF	
	Reset	81 01 04 44 00 00 p q FF	pq: B Gain
CAM_AE	Full auto	81 01 04 39 00 FF	Automatic Exposure mode
	Manual	81 01 04 39 03 FF	Manual Control mode
	Shutter Priority	81 01 04 39 0A FF	Shutter Priority Automatic Exposure mode
	Iris Priority	81 01 04 39 0B FF	Iris Priority Automatic Exposure mode
	Bright	81 01 04 39 0D FF	Bright Mode (Manual control)
CAM_Iris	Reset	81 01 04 0B 00 FF	Iris Setting

	Up	81 01 04 0B 02 FF	
	Down	81 01 04 0B 03 FF	
	Direct	81 01 04 4B 00 00 p q FF	pq: Iris Position
CAM_Shutter	Reset	81 01 04 0A 00 FF	Default Shutter Setting
	Up	81 01 04 0A 02 FF	
	Down	81 01 04 0A 03 FF	
	Direct	81 01 04 4A 00 00 p q FF	pq: Shutter Position
CAM_Backlight	On	81 01 04 33 02 FF	Back Light Compensation On/Off
	Off	81 01 04 33 03 FF	
CAM_Flicker	-	81 01 04 23 0p FF	p: Flicker Settings – (0: Off, 1: 50Hz, 2: 60Hz)
CAM_PictureEffect	Off	81 01 04 63 00 FF	Picture Effect Setting
	B&W	81 01 04 63 04 FF	
CAM_Memory	Reset	81 01 04 3F 0p pp FF	pp: Memory Number(Hex 0,0 – 3,F)
	Set	81 01 04 3F 01 pp FF	
	Recall	81 01 04 3F 02 pp FF	
Preset Recall Speed	Preset Speed	81 01 06 01 p FF	p: is speed grade,the values are (0x1~0x18)
CAM_LR_Reverse	On	81 01 04 61 02 FF	Image Flip Horizontal On/Off
	Off	81 01 04 61 03 FF	
CAM_PictureFlip	On	81 01 04 66 02 FF	Image Flip Vertical On/Off
	Off	81 01 04 66 03 FF	
Pan Tilt Drive	Up	81 01 06 01 VV WW 03 01 FF	VV: Pan Speed 0x01 (Low) to 0x18 (high) WW: Tilt Speed 0x01 (Low) to 0x18 (high)
	Down	81 01 06 01 VV WW 03 02 FF	
	Left	81 01 06 01 VV WW 01 03 FF	
	Right	81 01 06 01 VV WW 02 03 FF	
	Up Left	81 01 06 01 VV WW 01 01 FF	
	Up Right	81 01 06 01 VV WW 02 01 FF	
	Down Left	81 01 06 01 VV WW 01 02 FF	
	Down right	81 01 06 01 VV WW 02 02 FF	
	Stop	81 01 06 01 VV WW 03 03 FF	
	Absolute Position	81 01 06 02 VV WW Y Y Y Y Z Z Z Z FF	YYYY: Pan Position
	Relative Position	81 01 06 03 VV WW Y Y Y Y Z Z Z Z FF	WWWW: Tilt Position
	Home	81 01 06 04 FF	
	Reset	81 01 06 05 FF	
	CAM_Brightness	Direct	81 01 04 A1 00 00 0p 0q FF
CAM_Contrast	Direct	81 01 04 A2 00 00 0p 0q FF	pq: Contrast Position
CAM-Flip	Off	81 01 04 A4 00 FF	Single Command For Video Flip
	Flip-H	81 01 04 A4 01 FF	

	Flip-V	81 01 04 A4 02 FF	
	Flip-HV	81 01 04 A4 03 FF	
CAM_SettingSave	Save	81 01 04 A5 10 FF	Save Current Setting
CAM_AWBSensitivity	High	81 01 04 A9 00 FF	High
	Normal	81 01 04 A9 01 FF	Normal
	Low	81 01 04 A9 02 FF	Low
CAM_AFZone	Top	81 01 04 AA 00 FF	AF Zone priority select
	Center	81 01 04 AA 01 FF	
	Bottom	81 01 04 AA 02 FF	
CAM_ColorHue	Direct	81 01 04 4F 00 00 00 0p FF	p: Color Hue 0h (-14 degrees) to Eh (+14 degrees)
OSD_Control	Open/Close	81 01 04 3F 02 5F FF	

Part 5: VISCA over IP Query Commands

Command	Command Package	Return Package	Note
CAM_ZoomPosInq	81 09 04 47 FF	90 50 p q r s FF	pqrs: Zoom Position
CAM_FocusAFModelInq	81 09 04 38 FF	90 50 02 FF	Auto Focus
		90 50 03 FF	Manual Focus
CAM_FocusPosInq	81 09 04 48 FF	90 50 0p 0q 0r 0s FF	pqrs: Focus Position
CAM_WBModelInq	81 09 04 35 FF	90 50 00 FF	Auto
		90 50 01 FF	Indoor Mode
		90 50 02 FF	Outdoor Mode
		90 50 03 FF	OnePush Mode
		90 50 05 FF	Manual
CAM_RGainInq	81 09 04 43 FF	90 50 00 00 0p 0q FF	pq: R Gain
CAM_BGainInq	81 09 04 43 FF	90 50 00 00 0p 0q FF	pq: R Gain
CAM_AEModelInq	81 09 04 39 FF	90 50 00 FF	Full Auto
		90 50 03 FF	Manual
		90 50 0A FF	Shutter Priority (SAE)
		90 50 0B FF	Iris Priority (AAE)
		90 50 0D FF	Bright

CAM_ShutterPosInq	81 09 04 4A FF	90 50 00 00 0p 0q FF	pq: Shutter Position
CAM_IrisPosInq	81 09 04 4B FF	90 50 00 00 0p 0q FF	pq: Iris Position
CAM_BrightPosInq	81 09 04 4D FF	90 50 00 00 0p 0q FF	pq: Bright Position
CAM_ExpCompModeInq	81 09 04 3E FF	90 50 02 FF	On
		90 50 03 FF	Off
CAM_ExpCompPosInq	81 09 04 4E FF	90 50 00 00 0p 0q FF	pq: ExpComp Position
CAM_BacklightModeInq	81 09 04 33 FF	90 50 02 FF	On
		90 50 03 FF	Off
CAM_Noise2DModelInq	81 09 04 50 FF	90 50 02 FF	Auto Noise 2D
		90 50 03 FF	Manual Noise 2D
CAM_Noise2DLevel	81 09 04 53 FF	90 50 0p FF	Noise Reduction (2D) p: 0 to 5
CAM_Noise3DLevel	81 09 04 54 FF	90 50 0p FF	Noise Reduction (3D) p: 0 to 8
CAM_FlickerModelInq	81 09 04 55 FF	90 50 0p FF	p: Flicker Settings(0: OFF, 1: 50Hz, 2: 60Hz)
CAM_ApertureModelInq (Sharpness)	81 09 04 05 FF	90 50 02 FF	Auto Sharpness
		90 50 03 FF	Manual Sharpness
CAM_ApertureInq	81 09 04 42 FF	90 50 00 00 0p 0q FF	pq: Aperture Gain
CAM_PictureEffectModelInq	81 09 04 63 FF	90 50 02 FF	Off
		90 50 04 FF	B&W

CAM_LR_ReverseInq	81 09 04 61 FF	90 50 02 FF	On
		90 50 03 FF	Off
CAM_PictureFlipInq	81 09 04 66 FF	90 50 02 FF	On
		90 50 03 FF	Off
CAM_ColorGainInq	81 09 04 49 FF	90 50 00 00 00 0p FF	p: Color Gain setting 0h (60%) to Eh (200%)
CAM_PanTiltPosInq	81 09 06 12 FF	90 50 0w 0w 0w 0w	www: Pan Position
		0z 0z 0z 0z FF	zzzz: Tilt Position

CAM_GainLimitInq	81 09 04 2C FF	90 50 0q FF	p: Gain Limit
CAM_BrightnessInq			
CAM_ContrastInq			
CAM_FlipInq	81 09 04 A4 FF	90 50 00 FF	Off
		90 50 01 FF	Flip-H
		90 50 02 FF	Flip-V
		90 50 03 FF	Flip-HV
CAM_AFZone	81 09 04 AA FF	90 50 00 FF	Top
		90 50 01 FF	Center
		90 50 02 FF	Bottom
CAM_ColorHueInq	81 09 04 4F FF	90 50 00 00 00 0p FF	p: Color Hue setting 0h (-14 degrees) to Eh (+14 degrees)
CAM_AWBSensitivityInq	81 09 04 A9 FF	90 50 00 FF	High
		90 50 01 FF	Normal
		90 50 02 FF	Low

Part 6: Pelco-D Protocol Command List

Function	Byte1	Byte2	Byte3	Byte4	Byte5	Byte6	Byte7
Up	0xFF	Address	0x00	0x08	Pan Speed	Tilt Speed	SUM
Down	0xFF	Address	0x00	0x10	Pan Speed	Tilt Speed	SUM
Left	0xFF	Address	0x00	0x04	Pan Speed	Tilt Speed	SUM
Right	0xFF	Address	0x00	0x02	Pan Speed	Tilt Speed	SUM
Zoom In	0xFF	Address	0x00	0x20	0x00	0x00	SUM
Zoom Out	0xFF	Address	0x00	0x40	0x00	0x00	SUM
Focus Far	0xFF	Address	0x00	0x80	0x00	0x00	SUM
Focus Near	0xFF	Address	0x01	0x00	0x00	0x00	SUM
Set Preset	0xFF	Address	0x00	0x03	0x00	Preset ID	SUM
Clear Preset	0xFF	Address	0x00	0x05	0x00	Preset ID	SUM
Call Preset	0xFF	Address	0x00	0x07	0x00	Preset ID	SUM
Auto Focus	0xFF	Address	0x00	0x2B	0x00	0x01	SUM
Manual Focus	0xFF	Address	0x00	0x2B	0x00	0x02	SUM
Query Pan Position	0xFF	Address	0x00	0x51	0x00	0x00	SUM
Query Pan Position Response	0xFF	Address	0x00	0x59	Value High Byte	Value Low Byte	SUM
Query Tilt Position	0xFF	Address	0x00	0x53	0x00	0x00	SUM
Query Tilt Position Response	0xFF	Address	0x00	0x5B	Value High Byte	Value Low Byte	SUM
Query Zoom Position	0xFF	Address	0x00	0x55	0x00	0x00	SUM
Query Zoom Position Response	0xFF	Address	0x00	0x5D	Value High Byte	Value Low Byte	SUM

Part 7: Pelco-P Protocol Command List

Function	Byte1	Byte2	Byte3	Byte4	Byte5	Byte6	Byte7	Byte8
Up	0xA0	Address	0x00	0x08	Pan Speed	Tilt Speed	0xAF	XOR
Down	0xA0	Address	0x00	0x10	Pan Speed	Tilt Speed	0xAF	XOR
Left	0xA0	Address	0x00	0x04	Pan Speed	Tilt Speed	0xAF	XOR
Right	0xA0	Address	0x00	0x02	Pan Speed	Tilt Speed	0xAF	XOR
Zoom In	0xA0	Address	0x00	0x20	0x00	0x00	0xAF	XOR
Zoom Out	0xA0	Address	0x00	0x40	0x00	0x00	0xAF	XOR
Focus Far	0xA0	Address	0x00	0x80	0x00	0x00	0xAF	XOR
Focus Near	0xA0	Address	0x01	0x00	0x00	0x00	0xAF	XOR
Set Preset	0xA0	Address	0x00	0x03	0x00	Preset ID	0xAF	XOR
Clear Preset	0xA0	Address	0x00	0x05	0x00	Preset ID	0xAF	XOR
Call Preset	0xA0	Address	0x00	0x07	0x00	Preset ID	0xAF	XOR
Auto Focus	0xA0	Address	0x00	0x2B	0x00	0x01	0xAF	XOR
Manual Focus	0xA0	Address	0x00	0x2B	0x00	0x02	0xAF	XOR
Query Pan Position	0xA0	Address	0x00	0x51	0x00	0x00	0xAF	XOR
Query Pan Position Response	0xA0	Address	0x00	0x59	Value High Byte	Value Low Byte	0xAF	XOR
Query Tilt Position	0xA0	Address	0x00	0x53	0x00	0x00	0xAF	XOR
Query Tilt Position Response	0xA0	Address	0x00	0x5B	Value High Byte	Value Low Byte	0xAF	XOR
Query Zoom Position	0xA0	Address	0x00	0x55	0x00	0x00	0xAF	XOR
Query Zoom Position Response	0xA0	Address	0x00	0x5D	Value High Byte	Value Low Byte	0xAF	XOR



2321 Rue Cohen, Montreal, Quebec, Canada. H4R 2N7

Tel: (514) 905-0588 Fax: (514) 905-0589

Toll Free (North America): (877) 689-5228