



User Manual | **NA2-IO-DLINE**

Line I/O to Dante™ Interface



NEUTRIK®

Imprint

Subject to change due to technical advances! This user manual corresponds to the level of technology at the time the product was delivered and not the current stage of development at Neutrik.

If any pages or sections of this user manual are missing, please contact the manufacturer at the address listed below.

Copyright

This user manual is protected by copyright. The user manual must not be duplicated, reproduced, microfilmed or translated, or converted to be saved and processed in IT systems, neither as excerpts nor in full, without the express written authorization of Neutrik.

Copyright by: © Neutrik® AG

Document identification

Document No: BDA 537

Version: 2018/04

Language: English

Original language: German

Each user manual in a different language is a translation of the operating manual in German.

Manufacturer

Neutrik® AG
Im alten Riet 143
9494 Schaan
Liechtenstein

T: +423 2372424

F: +423 2325393

E: neutrik@neutrik.com

www.neutrik.com



Table of contents

1 About this document	4
1.1 Significance of the user manual	4
1.2 Designations	4
1.3 Explanation of symbols	5
1.3.1 Symbols in illustrations	5
1.4 Target group	5
2 Safety	6
2.1 Warning information and signal words	6
2.2 Warning symbols	6
2.3 Important regulatory notes	6
2.3.1 Declaration of conformity	7
2.4 Important safety instructions	7
2.5 Intended use	7
2.6 Foreseeable improper use	7
3 Description of product	8
3.1 What is the Dante™ adapter?	8
3.2 Device	8
3.3 Connections and displays	8
4 Operation	10
4.1 Preparations	10
4.2 Connecting devices with the Dante™ adapter	10
4.2.1 Connection diagram using a switch with PoE support	11
4.2.2 Connection diagram using a switch without PoE support	11
4.3 Applications	12
4.3.1 Converting an analog audio signal into a Dante™ signal	12
4.3.2 Converting a Dante™ signal into an analog audio signal	12
4.3.3 Signal conversion in both directions (mixed mode)	12
4.4 Controlling the Dante™ adapter with the Dante™ controller	13
4.4.1 Enabling a Dante™ link	13
5 After operation	14
5.1 Dismounting devices	14
5.2 Transporting	14
5.3 Storage	14
5.4 Cleaning and care	14
5.5 Maintenance and repair	14
5.6 Disposal	15
6 Appendix	16
6.1 Technical specifications	16

1 About this document

This user manual provides an overview of the necessary operation steps and settings on the product.

1.1 Significance of the user manual

- i** This user manual is an integral component of the product and part of the product's safety concept.
 - ▶ Make sure that all persons who work with the product have fully read and also understood this user manual.
 - ▶ Observe all instructions exactly, especially the safety instructions.

- i** This user manual contains important information for safely and properly operating the product.
 - ▶ Keep this user manual in the immediate vicinity of the product so personnel have access to it at all times.

- ▶ Pass this user manual on to every user, e.g., by lending it, or to the future owner of the product.
- ▶ If this user manual is lost or damaged, a copy of it can be downloaded from the Neutrik's website (www.neutrik.com).

1.2 Designations

Designation	Explanation
Dante™ adapter	Dante™ adapter NA2-IO-DLINE; to create the easy-to-read texts, the device is hereinafter referred to as Dante™ adapter.
Dante™ audio networking	Dante™ audio networking (hereinafter referred to as Dante™) Dante™ stands for D igital A udio N etwork T hrough E thernet and is an audio network protocol developed by the Australian company Audinate. Dante™ delivers uncompressed, multichannel, low-latency digital audio over a standard Ethernet network using Layer 3 IP packets.
PoE	Power over Ethernet; the device is supplied with power via the network connection.
Peripheral devices	All devices that can be connected to the Dante™ adapter: audio sources (transmitters) and audio sinks (receivers)
Audio source	All devices that emit an audio signal
Audio sink	All devices that receive the audio signals, e.g., loudspeakers, audio systems (amplifiers, mixing consoles, etc.)



1.3 Explanation of symbols

In order to make this user manual easier to understand, uniform safety instructions, symbols, terms and abbreviations were used. The following symbols designate instructions which are not relevant to safety, yet make it easier to understand the operating manual.

- ☑ The preconditions for an action are depicted with this symbol. Complete the specified items before carrying out the action steps which follow.
 - ▶ Action steps are designated by this symbol. Carry out the action steps in the order they are presented.
 - ✓ The result of the action or the reaction of the product to the action are depicted with this symbol.
 - Lists without a mandatory sequence are presented as a list with this bullet.
1. Numbered listings are displayed in this manner.
(1) Refers to a position in an illustration.

 Wherever you see this symbol, you will find useful information for safe, trouble-free operation of the product.

1.3.1 Symbols in illustrations

Symbol	Explanation
	Image position
	Action steps numbered in an illustration. Carry out the action steps in the order they are presented.

1.4 Target group

This user manual is addressed to sound engineers, musicians and personnel who have comprehensive experience in sound and event technology.

2 Safety

2.1 Warning information and signal words

Special warning information regarding potential dangers inherent in a particular action are presented before instructions for an action. The warnings are ranked as follows:

⚠ CAUTION

Possible threat of danger!

This type of warning points out a situation which could result in minor or moderate injuries.

- ▶ If this warning is not heeded, minor injuries may result.



⚠ NOTICE

Possible threat of property damage!

This type of warning points out a situation which could result in damage to the device and its components.

- ▶ If this warning is not heeded, property damage may result.

2.2 Warning symbols

Symbol	Warning
	General warning
	Warning of hearing impairment

2.3 Important regulatory notes

This equipment has been tested and found to comply with the limits for a Class B digital device, pursuant to Part 15 of the FCC Rules. These limits are designed to provide reasonable protection against harmful interference in a residential installation. This equipment generates, uses and can radiate radio frequency energy and, if not installed and used in accordance with the instructions, may cause harmful interference to radio communications. However, there is no guarantee that interference will not occur in a particular installation. If this equipment does cause harmful interference to radio or television reception, which can be determined by turning the equipment off and on, the user is encouraged to try to correct the interference by one or more of the following measures:

- Reorient or relocate the receiving antenna.
- Increase the separation between the equipment and receiver.
- Connect the equipment into an outlet on a circuit different from that to which the receiver is connected.
- Consult the dealer or an experienced radio/TV technician for help.

⚠ NOTICE

Changes or modifications made to this equipment not expressly approved by Neutrik may void the FCC authorization to operate this equipment.

2.3.1 Declaration of conformity

The device meets all the relevant EU directives and therefore has the CE marking. The Declaration of Conformity may be consulted at www.neutrik.com/en/approvals-and-certificates.

2.4 Important safety instructions

Avoid property damage to the Dante™ adapter due to unsuitable operating and environmental conditions:

- Never immerse in water.
- Protect from strong sunlight.
- Never install the device near heat sources such as radiators, heating units, ovens or stoves.
- Never cover the device, to avoid overheating.
- Protect the device from impact and above all, from falling from poles, stages, tables or furniture.

Repair

⚠ NOTICE**Property damage due to improper repair!**

The Dante™ adapter does not contain any parts which you can repair yourself. Opening or repairing the devices on your own can lead to severe damage to the device.

- ▶ Do not open the housing of the Dante™ adapter under any circumstances.
- ▶ Do not exchange any parts yourself.
- ▶ Only have the Dante™ adapter repaired by a authorized specialist dealer.

Information for operation

- ▶ Ensure that the ambient conditions specified for the Dante™ adapter are observed during operation.
- ▶ Do not use the Dante™ adapter if it is not functioning properly, have fallen or been damaged, have become wet or if parts of it have been immersed in water.
- ▶ If disruptions occur during operation:
Immediately disconnect the Dante™ adapter from audio sources and/or audio sinks.
- ▶ Do not operate the Dante™ adapter in environments where flammable or explosive materials, gases or vapors are present or could occur.

2.5 Intended use

The Dante™ adapter is designed for converting the signal of an analog LINE audio signal into a Dante™ signal. Dante™ signals can also be converted into analog LINE signals.

2.6 Foreseeable improper use

The Dante™ adapter is not suitable for use outdoors and in potentially explosive atmospheres.

3 Description of product

3.1 What is the Dante™ adapter?

The Dante™ adapter is an end-of-network device. It is a breakout box which allows two channels of audio to be integrated into a Dante™ network. Simultaneously, Dante™ adapter converts a Dante™ stream into analog audio signals. Hence, it is possible to use this tiny box to feed analog audio signals into the Dante™ network while at the same time receiving a mix from another Dante™ source.

The Dante™ adapter is designed for harsh stage conditions. It therefore features lockable chassis connectors for both the audio and network connections. For fixed installations, the rubber protection can be removed. With optional mounting brackets or a rack panel, the box can be mounted below tables, in floor boxes, or in equipment racks.

3.2 Device



Pos.	Description
1	Sheet metal housing
2	Rubber protection (removable)
3	Connections and displays

3.3 Connections and displays

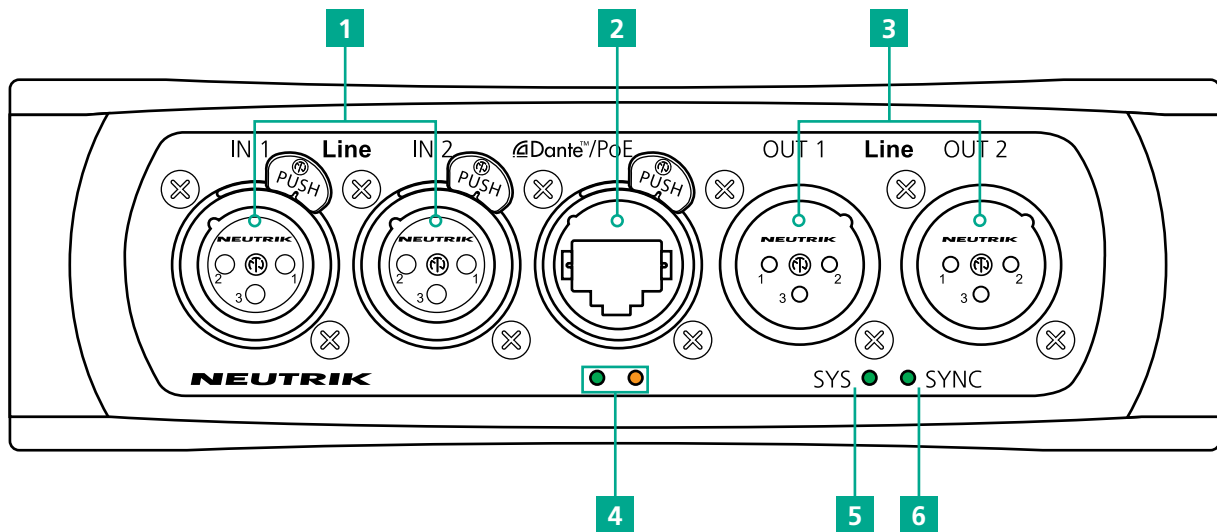

Pos.	Description
1	Balanced XLR inputs <ul style="list-style-type: none">Inputs for analog line signals (IN 1 and IN 2)
2	Network connection (RJ45, PoE) <ul style="list-style-type: none">Input/output for Dante™ networkDante™ adapter power supply
3	Balanced XLR outputs <ul style="list-style-type: none">Outputs for analog line signals (OUT 1 and OUT 2)
4	Network status LED
5	SYS LED <p>Indicates the device's system status.</p> <ul style="list-style-type: none">LED lights up red: system is starting.LED lights up green: system is ready.

Pos.	Description
6	SYNC LED <p>Indicates the Dante transfer status.</p> <ul style="list-style-type: none">LED lights up yellow: the system searches for SYNC.LED lights up red: SYNC errorLED lights up green: the device is in Slave mode. The mode is managed via the Dante™ Controller.LED flashes green: the device is in Master mode. The mode is managed via the Dante™ controller.
	SYS + SYNC LED flashes green: the device has been identified via the identification function of the Dante™ Controller.

4 Operation

4.1 Preparations

- ▶ Unpacking the Dante™ adapter.
- ▶ Save packaging for later transport and storage.
- ▶ Check the packaging and Dante™ adapter for visible damage.
- ▶ When visible damage to the packaging and/or delivered parts is detected:
Contact the salesperson or Neutrik sales partner.
- ▶ Do not use damaged devices under any circumstances.

4.2 Connecting devices with the Dante™ adapter

The Dante™ adapter can be connected to a Dante™ network via a standard 100 Mb/s twisted-pair Ethernet cable (CAT5e). This individual connection is responsible for the data transfer as well as for the power supply. Depending on the cable length and shield, we do not recommend installing cables parallel to power supply lines.

i The Dante™ adapter requires a switch that supports PoE (48 V). If a switch without PoE support is available, a PoE injector (compatible with 802.3af or 802.3at) must be connected in series.

⚠ NOTICE

Device damage due to a non-compliant PoE injector!

Non-compliant PoE injectors can damage the Dante™ adapter. The warranty is invalidated in this case.

- ▶ Only use a PoE injector that complies with IEEE 802.3af or 802.3at.

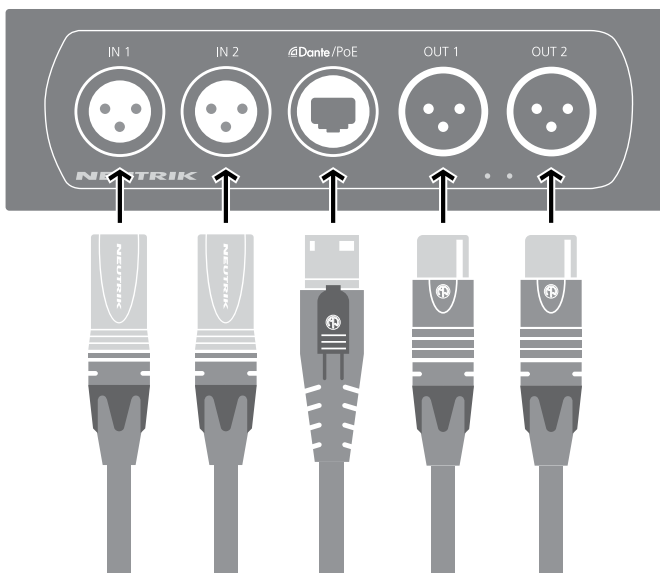

⚠ CAUTION



Danger of damage to hearing!

Signal peaks may occur when an audio source or sink is connected.

- ▶ Before making connections, mute the signal path of the peripheral devices.

- ▶ Connect the device depending on the desired application.
e.g. audio source for LINE IN, audio sink for LINE OUT.
- ▶ Connect the Dante™ adapter to the PoE switch using a network cable.
- ▶ If the switch does not support PoE:
Use a PoE injector.
- ✓ LEDs light up once the Dante™ adapter is supplied with power via the switch or the PoE injector.
- ✓ The Dante™ adapter is ready for operation.
- ✓ Set up the desired audio connection with the "Dante™ controller" software.

4.2.1 Connection diagram using a switch with PoE support

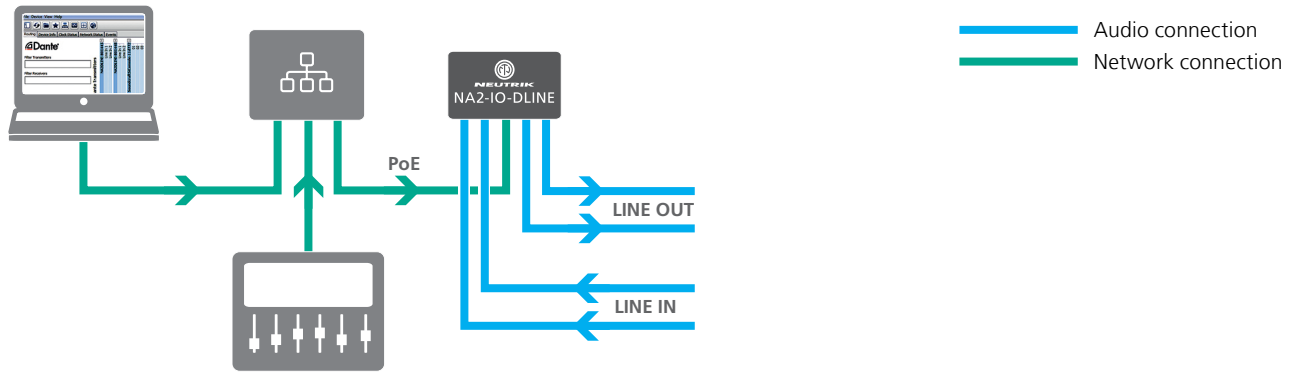

i The Dante™ adapter forwards information to the PoE switch indicating that it is a "Class 1" device to ensure the correct power supply.

4.2.2 Connection diagram using a switch without PoE support

⚠ NOTICE

Device damage due to a non-compliant PoE injector!

Non-compliant PoE injectors can damage the Dante™ adapter. The warranty is invalidated in this case.

► Only use a PoE injector that complies with IEEE 802.3af or 802.3at.

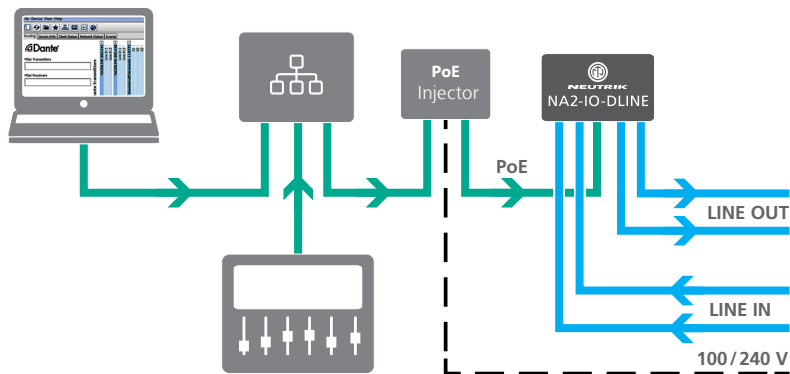

4.3 Applications

4.3.1 Converting an analog audio signal into a Dante™ signal

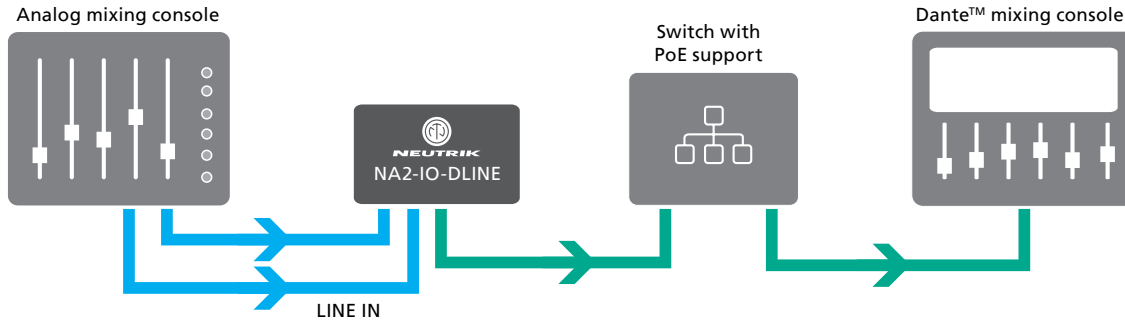

Here, the Dante™ adapter is used to integrate up to 2 analog LINE signals into a Dante™ system.

4.3.2 Converting a Dante™ signal into an analog audio signal

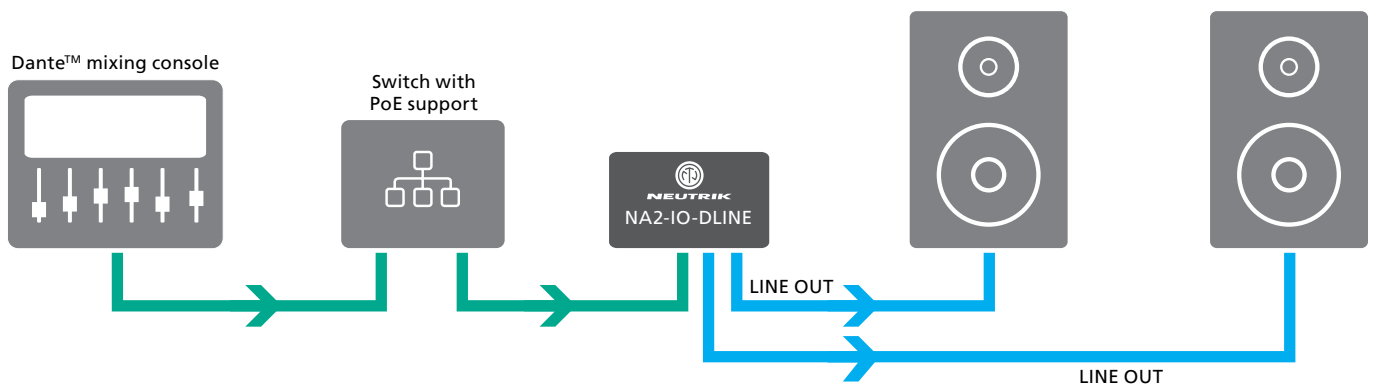

Loudspeakers and amplifiers that do not support Dante™ can be connected to a Dante™ network using the Dante™ adapter.

4.3.3 Signal conversion in both directions (mixed mode)

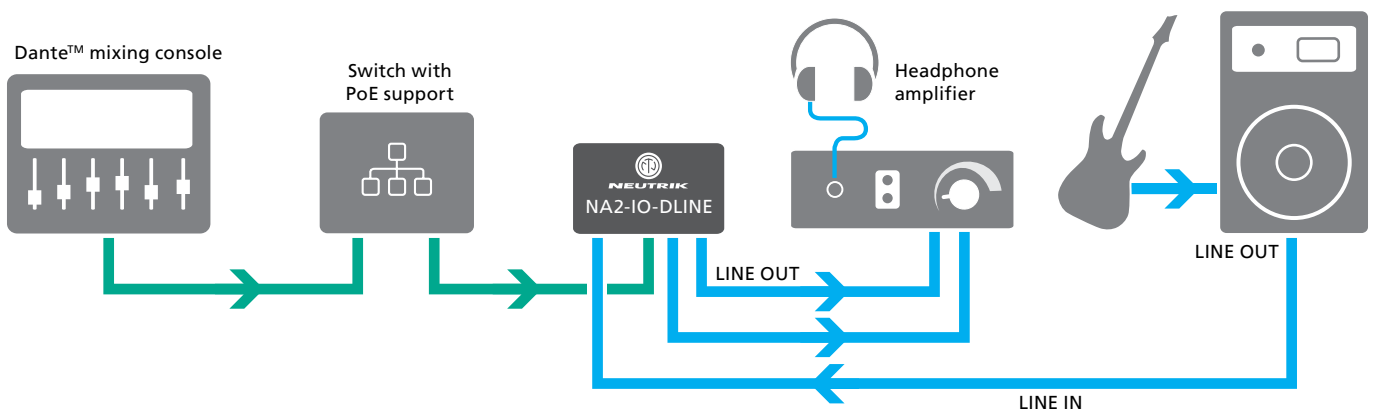

Using the Dante™ adapter, the two applications described above can also be operated simultaneously (= mixed mode).

4.4 Controlling the Dante™ adapter with the Dante™ controller

The Dante™ controller is a free software application that enables routing of audio signals and configuring devices in a Dante™ network. Setting up a Dante™ network is very easy. The Dante™ controller offers automatic device detection, one-click signal routing and user-editable device and channel labelings.

The software is available on the Audinate website (www.audinate.com).

4.4.1 Enabling a Dante™ link

- ▶ Download and install the "Dante™ Controller" software. (<https://www.audinate.com>).
- ▶ Connect the computer to the switch using a standard network cable.
- ▶ Run the "Dante™ Controller" software.
- ▶ In the routing menu, click the + symbols of the devices.
- ▶ Establish the desired link.

 The Dante™ adapter is displayed in the "Dante™ Controller" as a NA2DLINe by default, followed by a suffix with the last 6 digits of the MAC address. This name can be customized for each device in the Dante™ controller.

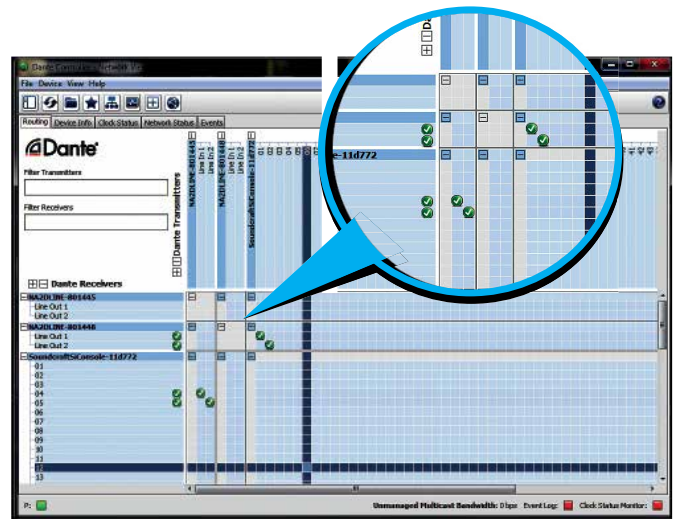

The "Dante™ Controller" software is solely used to set up the audio connection (routing) between devices and to configure the involved devices.

During operation, the computer and the "Dante™ Controller" software can be disconnected from the network, since all relevant information remains saved on the involved devices.

5 After operation

5.1 Dismounting devices

- ▶ Disconnect devices from audio sources/sinks.

5.2 Transporting

- ▶ Always transport devices and accessories in the original packaging.

5.3 Storage

- ▶ If devices are not used for a longer period:
Disconnect the device from the connected devices.
- ▶ Always store devices in a clean, dry location.
- ▶ Always protect devices from dirt, dust, heat, humidity and moisture.

5.4 Cleaning and care

⚠ NOTICE

Danger of property damage due to improper cleaning!

- ▶ Disconnect device from all connections before cleaning.
 - ▶ Never immerse device or accessory in water under any circumstances.
 - ▶ Never spray device or accessory with liquids under any circumstances.
-
- ▶ Wipe the surfaces of the device and accessory with a soft cloth slightly moistened with a mild soap solution.
 - ▶ Never use aggressive, solvent-based or abrasive cleaning agents under any circumstances.
 - ▶ Never use rough materials (e.g., cleaning cloths or sponges with a rough coating).

5.5 Maintenance and repair

The Dante™ adapter does not contain any parts which can be maintained or repaired by the user.

- ▶ Only have the Dante™ adapter repaired by a specialist dealer authorized by Neutrik.
- ▶ Check the Dante™ adapter regularly for visible damage to the housings, controls, connections, cables and plugs.
- ▶ If damage is detected, do not use device under any circumstances.
- ▶ Immediately decommission the damaged device.
- ▶ Replace defective cables or accessories immediately.

5.6 Disposal



- ▶ Dispose of the Dante™ adapter and accessories in accordance with the applicable local regulations.
- ▶ Never dispose of electrical devices or electrical accessories such as cables, plug, batteries or components with household wastes under any circumstances.

- ▶ Dispose of packaging and packaging elements in accordance with the applicable local regulations.
- ▶ Take device components made of plastic, metal or other recyclables for reclamation in accordance with the applicable local regulations.

6 Appendix

6.1 Technical specifications

Dante™ specifications

Channels	2 INPUTS (line level), 2 OUTPUTS (line level)
Supported sampling rates	44.1 / 48 / 88.2 / 96 kHz
Bit depth	16, 24 and 32 Bit
Latency	Depending on the network configuration, 1 ms (standard)
Ethernet connection	100BASE-TX (PoE support)

Electrical specifications

Power consumption	< 2 watts
Power supply	PoE switch (Power over Ethernet) or PoE injector (according to IEEE 802.3af/at, class 1)

Analog audio input

Input impedance	6.6 kOhm
Input level (balanced)	Max. 22 dBu
Frequency response	20 Hz to 20 kHz (+/-0.5 dB)
Dynamic range	> 100 dB
Signal-to-noise ratio	> 100 dB
THD + noise:	< 0.01 % @ + 4 dBu, A-weighting
Crosstalk	< -80 dB @ 20 kHz

Analog audio output

Output impedance	< 800 Ohm
Output level (balanced)	Max. 16 dBu
Frequency response	20 Hz to 20 kHz (+/-0.5 dB)
Dynamic range	> 100 dB
Signal-to-noise ratio	> 100 dB
THD + noise:	< 0.01 % @ + 4 dBu, A-weighting
Crosstalk	< -80 dB @ 20 kHz

Mechanical specifications

Weight	0.44 kg (1 pound)
Dimensions (with rubber protection)	L = 164 mm (6.3 inches) B = 82 mm (3.2 inches) H = 51 mm (2.0 inches)
Dimensions (without rubber protection)	L = 151 mm (5.9 inches) B = 66 mm (2.6 inches) H = 41 mm (1.6 inches)
Operating environment	Indoor
Operating temperature	-5°C to +70°C
Storage temperature	-40°C to +150°C







NA2-IO-DLINE

Liechtenstein (Headquarters)

NEUTRIK AG, Im alten Riet 143, 9494 Schaan
T +423 237 24 24, F +423 232 53 93, neutrik@neutrik.com

Germany / Netherlands / Denmark / Austria

Neutrik Vertriebs GmbH, Felix-Wankel-Strasse 1, 85221 Dachau, Germany
T +49 8131 28 08 90, neutrik@neutrik.de

Great Britain

Neutrik (UK) Ltd., Westridge Business Park, Cothey Way
Ryde, Isle of Wight PO33 1 QT
T +44 1983 811 441, sales@neutrik.co.uk

France

Neutrik France SARL, Rue du Parchamp 13, 92100 Boulogne-Billancourt
T +33 1 41 31 67 50, info@neutrik.fr

USA

Neutrik USA Inc., 4115 Taggart Creek Road, Charlotte, North Carolina, 28208
T +1 704 972 30 50, info@neutrikusa.com

Japan

Neutrik Limited, Yusen-Higashinohonbashi-Ekimaie Bldg., 3-7-19
Higashinohonbashi, Chuo-ku, Tokyo 103
T +81 3 3663 47 33, mail@neutrik.co.jp

Hong Kong

Neutrik Hong Kong LTD., Suite 18, 7th Floor Shatin Galleria
Fotan, Shatin
T +852 2687 6055, sales@neutrik.com.hk

China

Ningbo Neutrik Trading Co., Ltd., Shiqi Street, Yinxian Road West
Fengjia Villiage, Hai Shu District, Ningbo, Zhejiang, 315153
T +86 574 88250833, sales@neutrik.com.cn

India

Neutrik India Pvt. Ltd., Level 3, Neo Vikram, New Link Road,
Above Audi Show Room, Andheri West, Mumbai, 400053
T +91 982 05 43 424, anklesaria@neutrik.com

Associated companies

Contrik AG

Steinackerstrasse 35, 8902 Urdorf, Switzerland
T +41 44 736 50 10, contrik@contrik.ch

H. Adam GmbH

Felix-Wankel-Straße 1, 85221 Dachau, Germany
T +49 08131 28 08-0, anfrage@adam-gmbh.de



www.neutrik.com