

OPTIONAL / ADDITIONAL EQUIPMENT

BRASS READING LAMP / #BRL

Attach an elegant brushed brass reading lamp to the reading table of your new Speaker Stand. Not only will you shed light on the subject, but you will add pizzazz to your new stand.



RECHARGEABLE BATTERY / #PS12V

Connect this 12V 5 amp rechargeable battery pack with included cable to any of our lecterns for battery power. 20 hour life. Lecterns recharge battery overnight.

ARISTOCRAT CONTOUR FLOOR LECTERN / #600

The perfect lectern for the most demanding, upscale look in your conference, training and formal meeting rooms. Contoured style with radius curves. Available in three woodgrain thermofused melamine laminate on MDF. Two built in shelves and our side mounted slide-out shelf for A/V presentation equipment. Accented by attractive T-mold edging. Moves effortlessly on four easy roll castors, two locking. Ready to assemble.

Dimensions: 23" W x 46 1/2" H x 16" D
Med. Oak, Mahogany, Cherry



HAND-HELD WIRELESS MIC. / LWM-5

This wireless hand-held Mic. Uses a 9-volt battery. Select channel A or B to eliminate outside frequency interruption. Move freely up to 200 ft. away!



TIE-CLIP LAVELIER WIRELESS MIC. / LWM-6

Includes pocket-size transmitter with a clip-on mic. Uses a 9-volt battery. Select channel A or B to eliminate outside frequency interruption. Move freely up to 200 ft. away!



HEADSET WIRELESS MIC. / LWM-7

Includes pocket-size transmitter with a headset mic. Uses a 9 volt battery. Select channel A or B to eliminate outside frequency interruption. Move freely up to 200 ft. away!



**Aristocrat
Sound Floor Lectern**

ASSEMBLY MANUAL



OKLAHOMA SOUND

149 Entin Road, Clifton, NJ 07014

Tel 973-594-9000 • Fax 973-594-9339

www.oklahomasound.com • email: info@oklahomasound.com

MODEL #6010

INTRODUCTION

Aristocrat Sound lectern - Model 6010

Perfect for the smallest to largest venues. Executive style podium includes 50 watt multimedia amplifier with two built in 8" speakers surrounded by gold appointments. Includes Microphones, Holders, Digital Timepiece and rolls on four casters. For audiences up to 2,500 people. Assembly required.

Colors: Walnut, Light Oak, Med. Oak, Mahogany/Black Edging

Dimensions: 25 1/4" W x 46" H x 20 1/4" D.

ASSEMBLY TIPS

- Do not use a sharp instrument such as a knife or a screwdriver to open the packaging, as this may scratch or possibly damage the unit.
- All assembly should be done on a clean protected surface such as carpet or the like.
- Make sure that you have all the required parts. A list of all the parts is included.
- Read instructions carefully and follow diagrams to ensure easy and correct assembly.

CARE OF YOUR CABINET

- All exterior and interior exposed surfaces are melamine covered as well as edges in matching patterned melamine material. To refresh the appearance, wipe the surface with a cloth soaked lightly in furniture oil. Avoid speaker grill area Your cabinet will look as good as new.

TECHNICAL SPECIFICATIONS

Power Output.....50W RMS at 10% THD	Power Supply ... 110-120V ohms DC 10.8 12V
MicElectret Condenser Mic (2)	Fuse 2A normal
Aux 150 mV>220K	Output 8 ohms
Frequency.....100HZ-25KHZ	Accessories..... Handheld mic; clip-on mic;
Response+ 3dB	gooseneck; Shockmount mic holder; digital clock

Manufacturers Warranty

Our lectern undergoes the most rigid and exacting tests for superior quality and performance before leaving the factory. Our lectern is made in America by American craftsmen. Oklahoma Sound Corporation warrants this product to be free from defective material and workmanship for five years from the date of resale by an authorized Oklahoma Sound distributor. Oklahoma Sound will replace defective parts and repair malfunctioning products under this warranty when the defect occurs under normal installation and use, provided the unit is returned to our factory via prepaid transportation after direct authorization and approval by Oklahoma Sound. This warranty provides that examination of the returned product must disclose in our judgement, a manufacturing defect. This warranty does not extend to any product which has been subject to misuse, neglect, accident, improper installation, or where the serial number has been removed or defected and is given in lieu of any other warranty implied or expressed and will not cover any consequential damages.

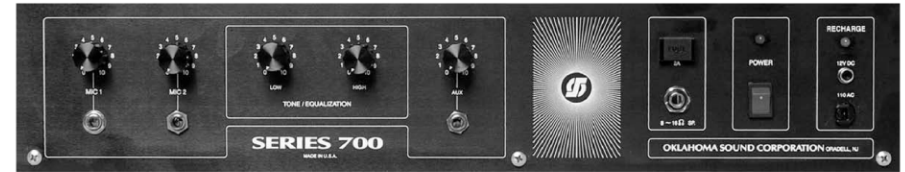

700 Series Amplifier Operating Instructions

Operating Precautions

Before operating the amplifier, be sure you fully understand all instructions and features of the amplifier. DO NOT turn amplifier on until all input and output connections have been made. NEVER replace fuses unless power is off.

Microphone Input Connection

The microphone input accepts 1/4" phone jack. Do not position microphone next to or facing speakers. This may cause acoustic feedback.

Auxiliary Input

One auxiliary input is provided for radio tune; tape recorder, CD player or multimedia equipment. Output level is adjusted by the auxiliary volume control.

Tone/Equalization Controls

The Low and High frequency controls are similar to the bass and treble controls found on most stereo systems. Optimum tone is achieved by first setting both knobs halfway; adjust Low and High frequency controls to suit environment.

Power Supply 12V DC Operation

Connect a 12 volt rechargeable battery 5 amp (not included) to the battery input connector located on the panel of the amplifier (using 6' battery cable). Be sure that the positive pole of battery is connected to the white wire terminal (+) and the negative pole to the Brass wire (-). When lectern is plugged into a standard wall outlet, the battery will automatically recharge. Green indicator light illuminates during recharge mode.

Precautions

- Set Mic volume control on lowest when turning unit on.
- Ensure correct polarity for D.C. supply connections.
- Reverse connections will blow the fuse and may damage internal circuitry.
- Always replace fuse with specified rating.

Removal and Installation of Amplifier

If your amplifier has to be removed for servicing — follow these simple steps:

- 1) Disconnect A/C wall plug.
- 2) Remove 4 side screws two on each side panel under amp top.
- 3) Disconnect speaker wire at rear of amplifier.
- 4) Pack it into a strong box with ample cushioning and return to factory
- 5) To install new amplifier reverse the above procedure.

4) Now apply Panel C to the semi assembled unit. Be sure to align the cam bolts to the holes on both Panel B and Panel E. Be sure that Panel F is securely in groove. Tighten cams. (Diagram C)

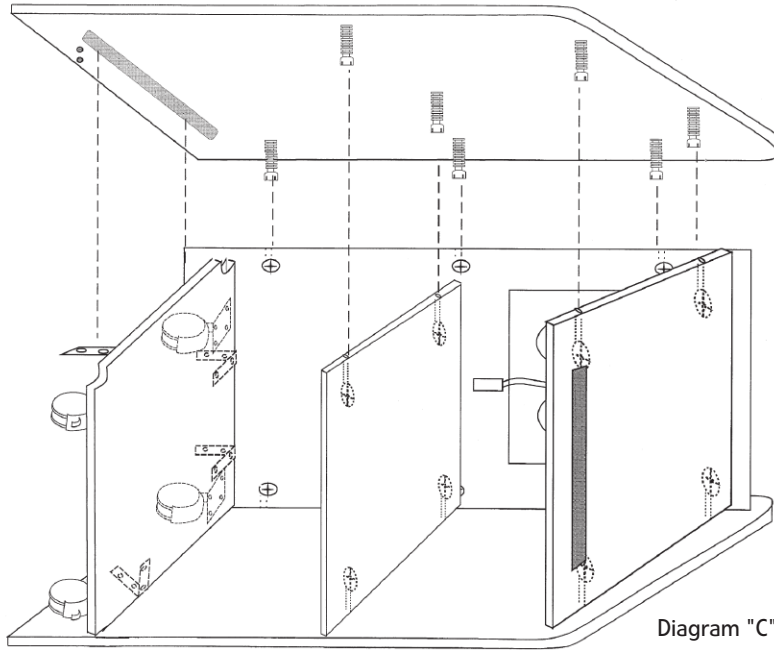

Diagram "C"

- 5) Screw the corner braces on the bottom Panel F into Panels A, B and C.
- 6) Connect the plug coming out of the speakers on Panel B to the plug coming out of the back of the amp. Fit the amp between the two sides and bring the amp up until it reaches the cleats (wood stub) then from the bottom of the amp screw in four screws. (Diagram D)
- 7) Once again go over all the cams and check to make sure the lectern is sturdy.
- 8) Screw on gooseneck mic holder and install microphone for sound use.

Congratulations! You have successfully assembled your lectern, which if cared for correctly should give you long and satisfactory usage.

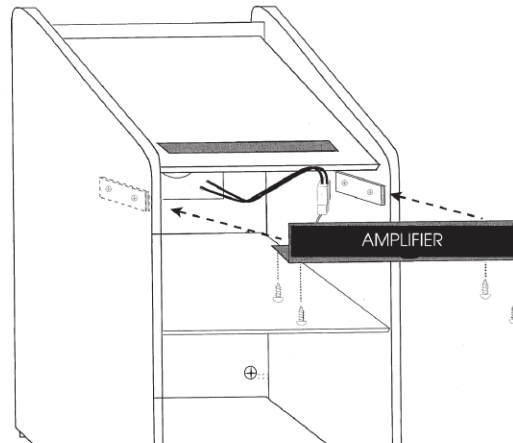
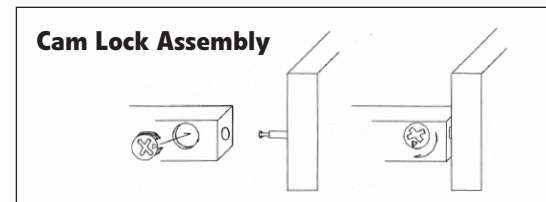
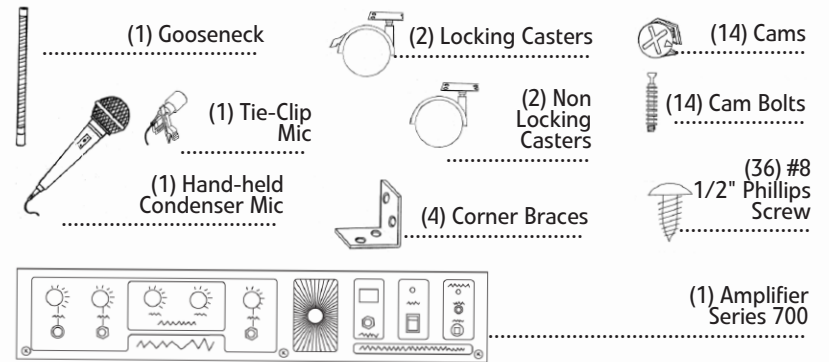
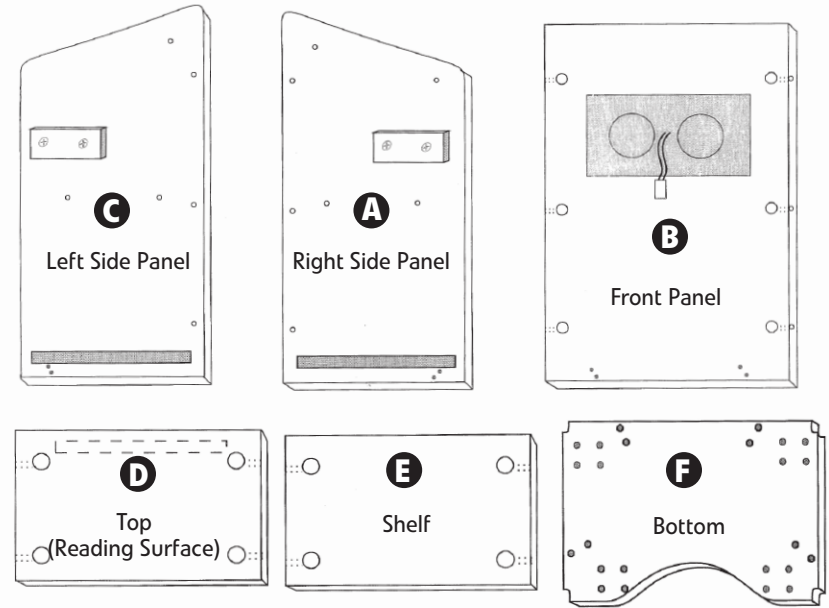

Diagram "D"

ASSEMBLY PARTS



Tools Required
 #2 Phillips Head Screwdriver
 Hammer

INSTALLATION OF HARDWARE

- 1) Lay out the wood panels as shown in Diagram A (make sure the factory drilled holes are facing upwards). You can determine the top of the front panel by identifying the T-molding.
- 2) Identify the holes numbered "1" in Diagram A. Screw the bolts into the pre-drilled holes with a #2 Phillips-head screwdriver. Be sure to tighten the screws all the way. Note: Be careful not to over-tighten the bolts as this will strip the wood!
- 3) Insert the cams in the larger holes as shown on diagram. **MAKE SURE THE ARROW ON THE CAM IS POINTING TO CLOSEST EDGE AND ALIGNED WITH THE HOLE ON THE EDGE.**
- 5) On Panel F, screw in the four casters. The locking casters should be screwed into the bottom closest to the T-molded contoured edge. The second pair of non-locking casters should be screwed in closest to the unfinished edge.

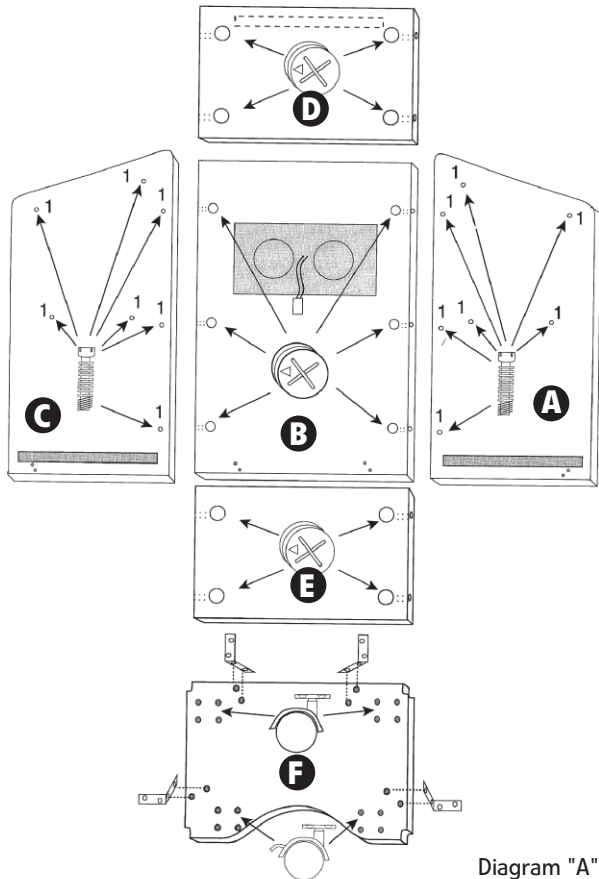

ASSEMBLY OF LECTERN

It is important that the instructions on the assembly are followed carefully

- 1) The first step of assembly will be to align the holes on Panel B edges with the three cam bolts on Panel A, tighten cams by turning clockwise until locked.
- 2) Next will be Panel D and Panel E. Make sure the cams on Panel D and Panel E face the bottom of the lectern. The two highest bolts align with the two holes on the edge of Panel D (these holes reach until the cams). The two bolts in the center of Panel A will align with the two holes on the edge of the shelf. Gently push the shelves down on to the cam bolts until the shelf is completely on the right side panel. Tighten.
- 3) Take Panel F, with the casters facing the bottom of the unit insert panel into the groove, make sure that the panel is all the way in the groove. (Diagram B)

