

ChannelPlus Data Modules

The H628 terminates data lines with CAT-5 jacks (RJ-45). Use CAT-5 jumper cables to route services to wall plates in the appropriate rooms of the house.

Wiring H628/H629
CAT-5 data hub
(H628 shown)

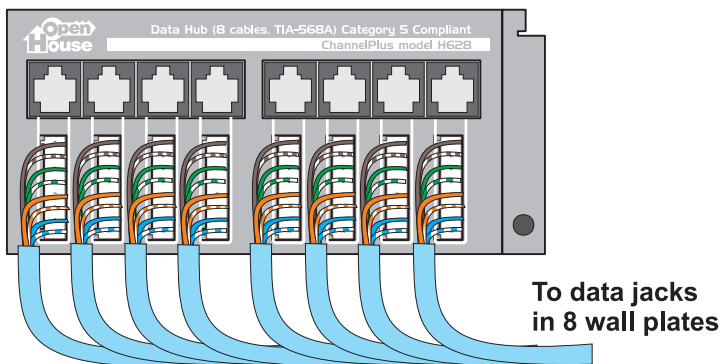

Sample system

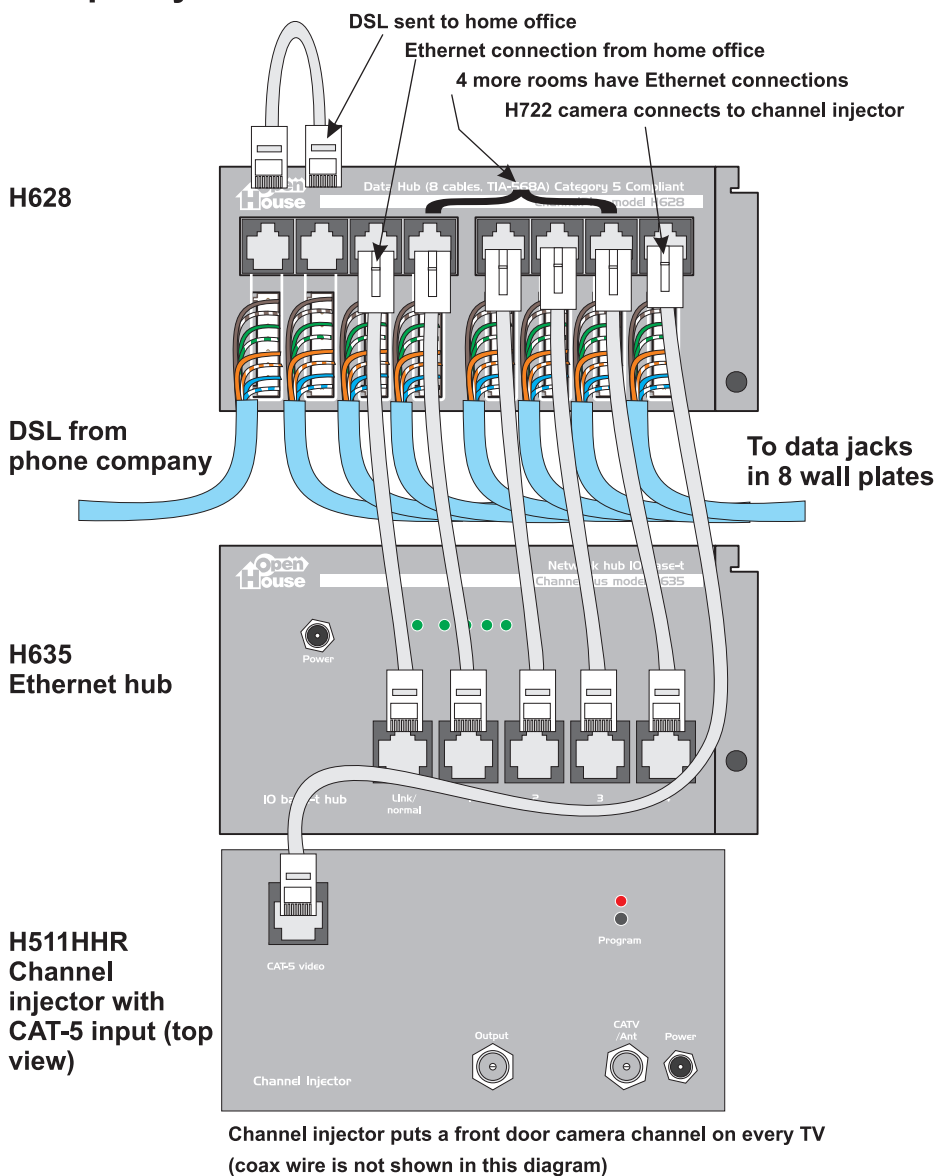

Using the H629 for telephone distribution

In a structured wire system, telephone outlets are wired using CAT-5 cables with a single RJ-45 jack at each end of the wire. To bring telephone to the jacks, bridge the telephone lines at the hub.

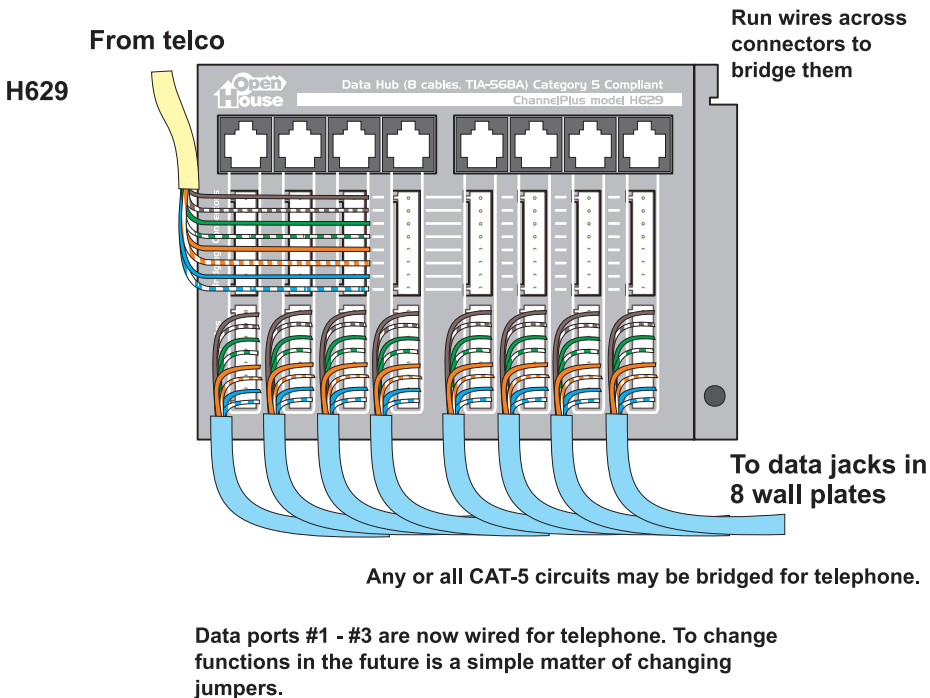

SAFETY INFORMATION:

- Never install telephone wiring during a lighting storm.
- Never install telephone jacks in wet locations.
- Never touch uninsulated telephone wires or terminals unless the telephone line has been disconnected at the network interface.
- Use caution when installing or modifying telephone lines.

OpenHouse™ modules attach from the top

- Hook from the top
- Swing into place
- Push button to lock

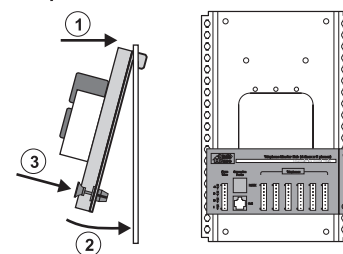

Wire Color Codes

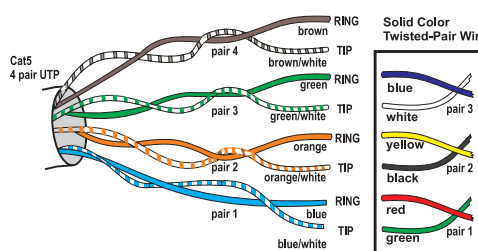

Modular connectors

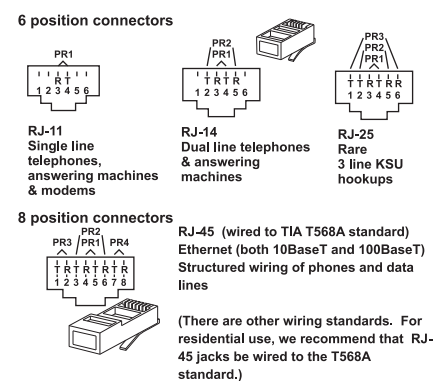

Wiring a 110 connector

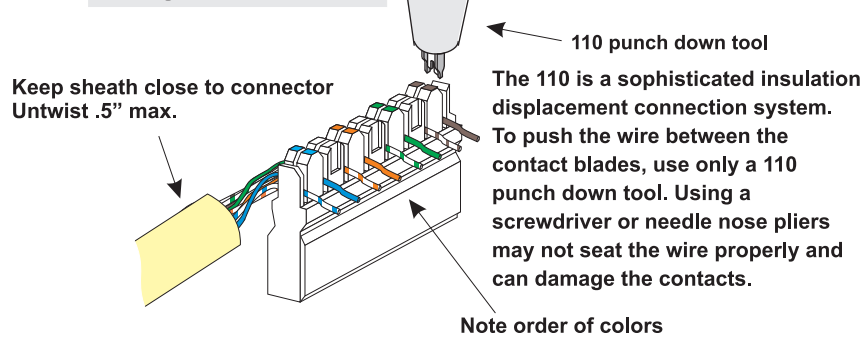

Wiring a Cat-5 jack

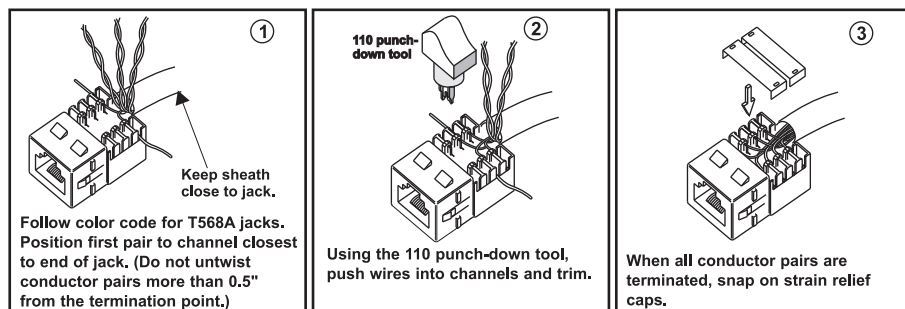

H628 CAT-5e performance

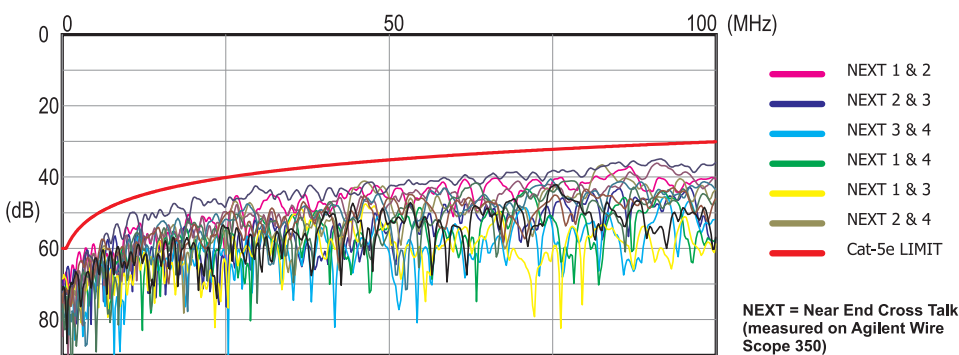

Wiring Modular Plug (T568A)

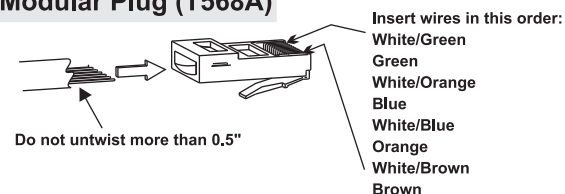

Colors of OpenHouse™ wiring

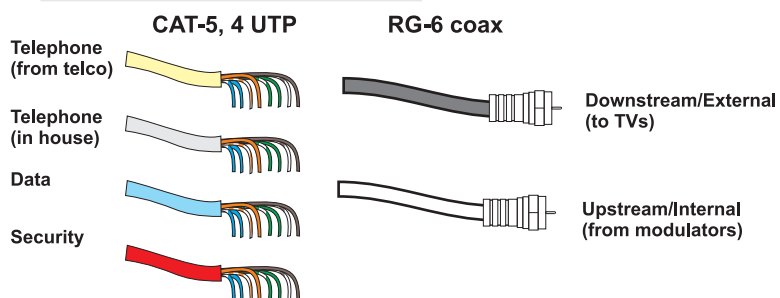

Good ...
 Typical room - phone, TV
 Media center - phone, satellite receiver, AV modulators
 Home office - phone, TV, cable modem
 Better ...
 Typical room - phone, TV, ethernet
 Media center - phone, TV, ethernet, satellite receiver, AV modulators
 Home office - phone, TV, ethernet, cable modem
 Best ...
 Typical room - phone, TV, ethernet, satellite receiver
 Media center - phone, TV, ethernet, satellite receiver, AV modulators, hi-speed data
 Home office - phone, TV, ethernet, satellite receiver, cable modem, hi-speed data

	1 Cat-5	1 Cat-5	1 Cat-5
Good	1 RG-6	3 RG-6	2 RG-6
Better	2 Cat-5	2 Cat-5	2 Cat-5
	1 RG-6	3 RG-6	2 RG-6
Best	2 Cat-5	3 Cat-5	2 Cat-5
	1 RG-6	3 RG-6	3 RG-6
	1 Cat-5	1 Cat-5	1 Cat-5
	2 RG-6	3 RG-6	3 RG-6
	1 Cat-5	1 Cat-5	1 Cat-5
	2 RG-6	3 RG-6	3 RG-6
	1 Cat-5	1 Cat-5	1 Cat-5
	2 RG-6	3 RG-6	3 RG-6

Typical Room Media Center Home Office

Wiring a house for OpenHouse
 The cables in an OpenHouse run from the various rooms of the house directly to the service center location. (This is known as 'home run' wiring.) Two types of wire are used for communication and entertainment: Cat-5, 4-UTP (4 Unshielded Twisted Pairs) wire handles data or 1 to 4 telephone lines. RG-6 coax handles television (antenna or cable), satellite dish, cable modem, or AV modulator signals. (An AV modulator creates new TV channels for front door camera, DVD player, a VCR or a satellite receiver.) We recommend the following pre-wire schemes. Run these wires from the service center to the rooms indicated.



Linear
 (760) 438-7000 USA & Canada (800) 996-5225
 Toll Free FAX (800) 468-1340
 www.openhousesystem.com

LIMITED WARRANTY STATEMENT

Linear LLC warrants this product to be free from defects in material and workmanship for 2 years. The time period will be measured using the date code labeled on the product. Linear LLC is not responsible for damage to the product resulting from the buyer's improper handling, stocking or warehousing of the product. Any implied warranty arising from the sale of the product including implied warranties of merchantability and fitness for purpose are limited. Linear LLC shall not be responsible for any losses, damages or expenses, whether direct, consequential, or incidental arising from the use or the inability to use the product. Some states and countries do not allow limitations or how long an implied warranty lasts or the exclusion or limitation or incidental or consequential damages, so the above exclusions may not apply. The Linear LLC warranty gives specific legal rights in addition to other rights, which may exist and vary from state to state and country to country.

The warranty is limited to repair or replacement of products returned, freight prepaid, to Linear LLC, there is NO PROVISION FOR LABOR COST OR OTHER REIMBURSEMENTS OF ANY KIND.

1. Failures due to product abuse, such as negligence, improper use, and electrical surge including damage from lightning, water damage or other damage due to natural disasters are not covered by the warranty. The most common form of product abuse is surge damage caused by lightning.
2. The warranty shall also be voided by any tampering with the date code, labels or other markings on the product.
3. Products that are damaged in transit to Linear LLC due to improper packaging or by the carrier (shipping company) will not be covered under the warranty. If the product was damaged or lost by the carrier, it is the sender's responsibility to create a claim against the carrier.
4. The user is responsible for all labor costs associated with removing, reinstalling and returning the product to Linear LLC.

Linear LLC, at its option, will repair or replace the defective product. Replacements will be made from B-Stock, if an exact replacement is not available, Linear LLC, at its option, will select the nearest equivalent product. The user is responsible for freight charges to Linear LLC. Linear LLC will return warranted repaired or replacements by UPS Ground or an equivalent service. A customer may pay the additional costs for second-day or next-day service.

All products returned for warranty service require a Return Product Authorization Number (RPA#). Contact Linear Technical Services at 1-800-421-1587 for an RPA# and other important details.



Compatible

ChannelPlus Enclosures, Modules, Accessories & Wall Plates

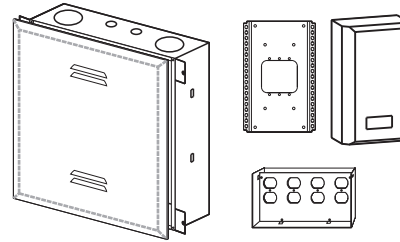

Service center enclosures

A full line of OpenHouse compatible enclosures, from simple, inexpensive mounting plates to high capacity in-wall cabinets. AC outlets can be mounted inside the cabinets using a UL listed accessory.

Starter systems

RF splitters and telephone punch downs. When it is time to upgrade, just snap this module out and replace with more sophisticated units.

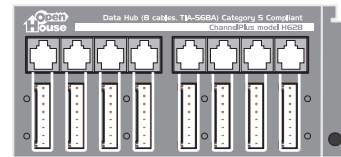
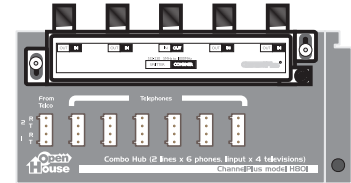

Data hubs

Termination blocks for the CAT-5 cables, Ethernet hubs. Bring the Internet to any room in the home. Or create a home data network.

Telephone hubs

Connections for 1-4 phone lines to every room. Starter hub adds RJ-31X jack for security system dialer.

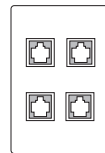
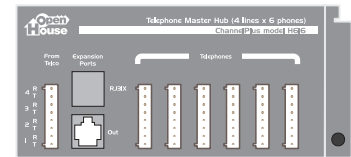

Wall plates

Wall plate systems for all rooms. The typical room gets TV and telephone. The Home office wall plate adds data ports. The media center wall plate adds satellite feeds.

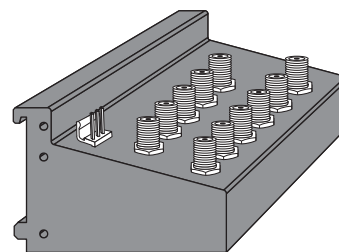

Coax panels

Distribute antenna or cable TV to every room of the house. Some models include bi-directional amplifiers for interactive cable systems. Some models include modulator inputs and IR engines.

AV modulators (for service center)

Create a new TV channel for a front door camera. Some models feature Cat-5 input connections.

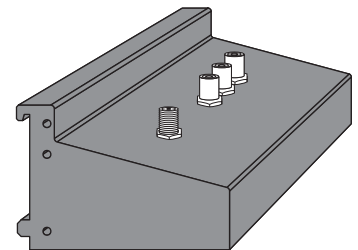

AV modulators (for media center)

Create new TV channels for DVD, VCR, or a satellite receiver. These modulators sit in the media center. Some offer true MTS stereo.

IR Accessories

Control video devices from any room.

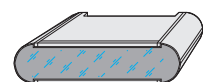

New ChannelPlus products are added all the time. Visit our website to learn more: www.openhousesystem.com