

PTZOptics 20x 3G-SDI (GEN 2)



User Manual

Model Nos: PT20X-SDI-GY-G2 & PT20X-SDI-WH-G2

V1.3

(English)

Please check PTZOPTICS.com for the most up to date version of this document

Rev 1.3 6/18



Preface

Thank you for using the HD Professional Video Conferencing Camera. This manual introduces the function, installation and operation of the HD camera. Prior to installation and usage, please read the manual thoroughly.

Precautions

This product can only be used in the specified conditions in order to avoid any damage to the camera:

- Don't subject the camera to rain or moisture.
- Don't remove the cover. Removal of the cover may result in an electric shock, in addition to voiding the warranty. In case of abnormal operation, contact the manufacturer.
- Never operate outside of the specified operating temperature range, humidity, or with any other power supply than the one originally provided with the camera.
- Please use a soft dry cloth to clean the camera. If the camera is very dirty, clean it with diluted neutral detergent; do not use any type of solvents, which may damage the surface.

Note

This is an FCC Class A Digital device. As such, unintentional electromagnetic radiation may affect the image quality of TV in a home environment.

Table of Contents

1	Supplied Accessories	1
2	Notes	1
3	Quick Start	2
4	Features	4
5	Product Specifications	5
6	Main Unit	7
7	IR Remote Controller	8
8	Using the IR Remote Controller	10
9	Dimensional Drawings	13
10	RS-232 Interface	14
11	VISCA Commands	16
12	VISCA over IP Commands	25
13	Menu Setting	32
14	Network Connection	36
15	Maintenance and Trouble Shooting	54

Supplied Accessories

When you unpack your camera, check that all the supplied accessories are included:

- Camera 1
- AC Power Adaptor 1
- Power Cord..... 1
- RS232 Cable 1
- IR Remote Controller 1
- This User Manual 1

Notes

- **Electrical Safety**

Installation and operation must be in accordance with national and local electric safety standards. Do not use any power supply other than the one originally supplied with this camera.

- **Polarity of power supply**

The power supply output for this product is 12VDC with a maximum current supply of 2A. Polarity of the power supply plug is critical and is as follows.



- **Handling**

- Avoid any stress, vibration, or moisture during transportation, storage, installation and operation.
 - Do not lift or move the camera by grasping the camera head. Do not turn the camera head by hand. Doing so may result in mechanical damage.
 - Do not expose camera to any corrosive solid, liquid, or gas to avoid damage to the cover which is made of a plastic material.
 - Ensure that there are no obstacles in the tilt or pan ranges of the camera lens.
 - Never power camera on before installation is complete.
- **Do not dismantle the camera** - The manufacturer is not responsible for any unauthorized modification or dismantling.

Quick Start

Step 1. Please check that all connections are correct before powering on the camera.

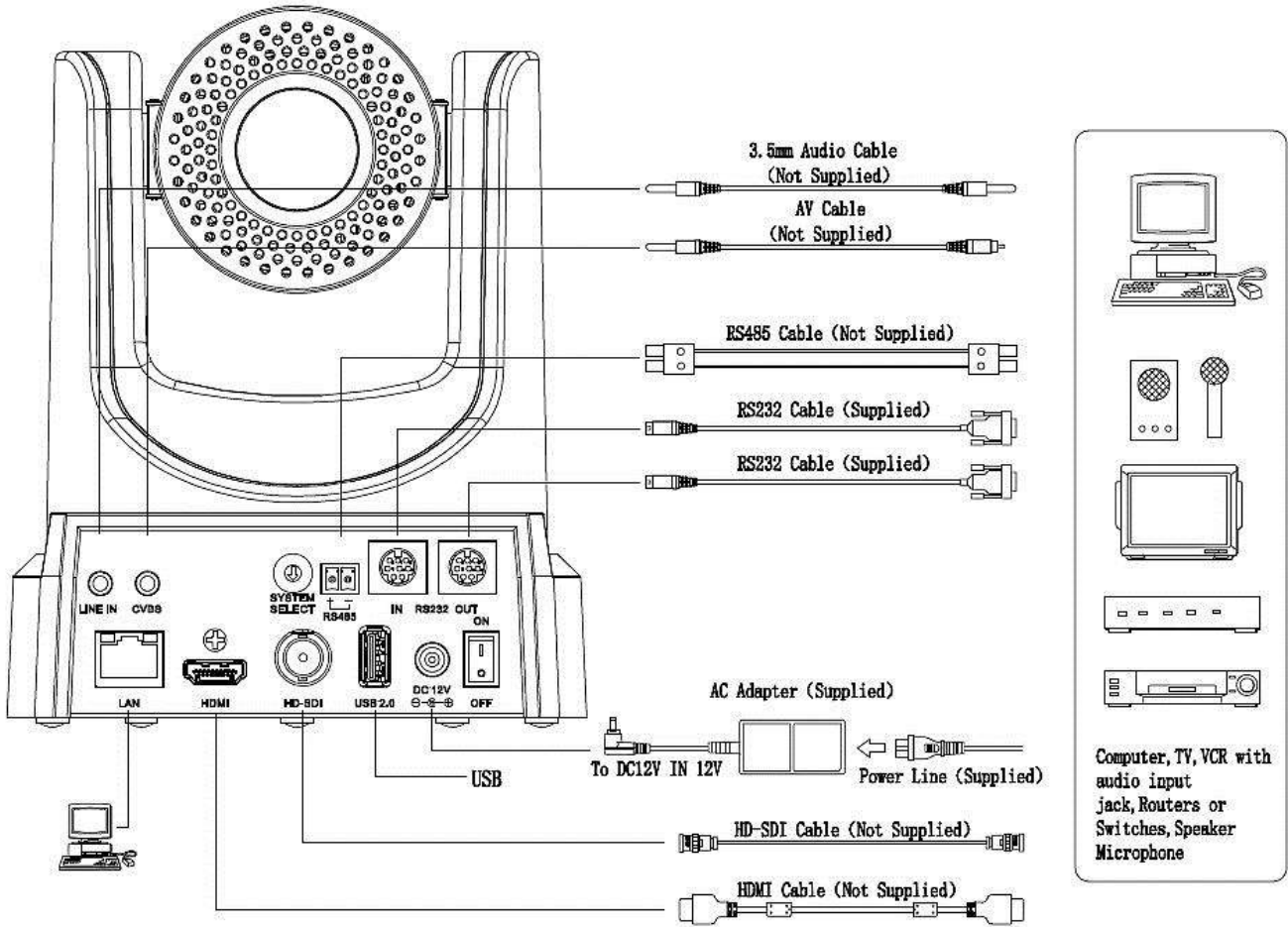

Step 2. Set the system select switch for your desired video output resolution and frame rate.

For many applications, setting 0 (1080p-60) will provide the best overall performance.

For highest possible resolution, use setting 0 (1080p-60) or 6 (1080p-30), however your actual realized frame rate may be limited to a lower value than 60 fps by your software and/or network connection.

NOTE: After changing this dial, you need to restart the camera to see the effect. Turn the camera off.

VIDEO SYSTEM			
0	1080p60	8	720p30
1	1080p50	9	720p25
2	1080i60	A	-
3	1080i50	B	-
4	720p60	C	-
5	720p50	D	576i
6	1080p30	E	480i
7	1080p25	F	-

CAUTION:

a. After changing the system (rotary) switch, you need to restart the camera to take effect.

Step 3. Press the Switch ON button on the rear of the camera, the power lamp will illuminate.

Step 4. The Pan-Tilt mechanism will rotate the lens to the maximum position of top right after the camera starts, then it will return to the “center”. The process of initialization is now complete. (Note: If the position preset 0 has been stored, the position preset 0 will be called up after initialization in lieu of “center”)

Step 5. (Optional) If you want to restore the factory default settings, press [MENU] button to display the OSD menu. Select the item [MENU] -> [RESTORE DEFAULT] -> [Restore]. Set the value [Yes], press [HOME] button to restore the factory default settings.

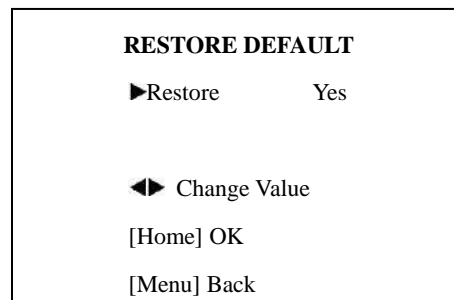



Features

1. Supports simultaneous 3G-SDI, HDMI and IP network streaming up to 1080p-60.
2. Supports non-simultaneous CVBS (composite video) output via RCA connector (480i or 576i).
3. Includes Panasonic's high quality, 1/2.7 inch, 2.07 million effective pixels, HD CMOS sensor, which can produce a maximum 1920 x 1080 image with a high quality, maximum output frame rate of 60 fps (frames per second).
4. Ultra-high frame rate 60fps for HDMI and USB and up to 120fps for IP Streaming (120fps at 720p only).
5. Supports IP streaming via RTSP and RTMP and using H.264, H.265 and MJPEG.
6. Microphone & AAC Audio Stream Encoding for IP stream & HDMI - Use a line-level microphone to embed audio. Uses AAC audio encoding for better sound quality and smaller bandwidth usage.
7. Includes a Tamron, high-quality, telephoto lens, supporting 20x optical zoom and optional 16x digital zoom with wide angle 60.7 degree horizontal field of view in widest zoom setting.
8. The high SNR (signal to noise ratio) of the CMOS sensor (≥ 55 dB), combined with 2D and 3D noise reduction algorithms, effectively reduces noise, even under low illumination conditions.
9. Includes DRC (dynamic range control), allowing for greater image quality and detail across images that are both well-lit and shadowed in the same frame.
10. Includes RS232 and RS485 interfaces for wired remote control. All of the parameters of the camera can be remotely controlled by high-speed communications for joystick and central control system applications.
11. Includes web-based IP remote control interface.
12. Freeze - Allows freezing of video image on all outputs to allow for calling next preset without showing camera motion.
13. Power over Ethernet - Supports PoE 802.3af

Product Specifications

Model	PT20X-SDI-GY-G2 and PT20X-SDI-WH-G2
Type	PTZ Optics 3G-SDI HD 1080p Color Video Camera (GEN 2)
Features	
Video System	1080p/60, 1080p/50, 1080i/60, 1080i/50, 1080p/30, 1080p/25, 720p/60, 720p/50, 720p/30, 720p/25 CVBS: 480i, 576i
Sensor	Panasonic 1/2.7", CMOS, Total Pixels: 2.12M, Effective Pixels: 2.07M
Scanning Mode	Progressive
Lens	20x; f4.42mm – 88.5mm; F1.8 - F2.8
Digital Zoom	16x
Minimal Illumination	0.5 Lux (@F1.8, AGC ON)
Shutter	1/30s - 1/10000s
White Balance	Auto, 3000K/Indoor, 4000K, 5000K/Outdoor, 6500K-1, 6500K-2, 6500K-3, One Push (ok), Manual
Backlight Compensation	Yes
Digital Noise Reduction	2D & 3D Digital Noise Reduction
Video S/N	≥55dB
Horizontal Angle of View	3.36° - 60.7°
Vertical Angle of View	1.89° - 34.1°
Horizontal Pan Range	±170°
Vertical Tilt Range	-30° to +90°
Pan Speed Range	1.7° - 100°/s
Tilt Speed Range	1.7° - 69.9°/s
Ceiling Installation	Yes
Image Mirroring	Yes
Number of Presets	255
Preset Accuracy	0.1°
Video coding standards	H.264, H.265, MJPEG
Video Freeze	Yes
Face Detection	Via Future Firmware Update
Local USB 2.0 Storage	Via Future Firmware Update
Input/Output	
USB Port	1x USB 2.0 Type A Female (*no video out* for future local video file storage)
HD Output	1x SDI (3G-SDI), BNC female
	1x HDMI Ver. 1.3
	1x RJ45 IP 10/100/1000 Ethernet Port



SD Output	1x CVBS: 3.5mm jack, 1Vp-p, 75Ω (requires adapter cable to connect to standard RCA input)
Network Interface and Output	1x RJ45: 10M/100M/1000M Adaptive Ethernet port
Audio Input	1-ch 3.5mm audio interface, LINE IN (embedded on IP Stream & HDMI only)
Control Input / Output	1x RS-232 In: 8pin Mini-DIN, Max Distance: 30m, Protocols: VISCA/Pelco-D/Pelco-P
	1x RS-232 Out (pass-through): 8pin Mini-DIN, Max Distance: 30m Protocols: VISCA/Pelco-D/Pelco-P
	1x RS-485: 2pin phoenix port, Max Distance: 1500m, Protocols: VISCA/Pelco-D/Pelco-P
IP Video Features	
Video Compression	H.265/H.264/M-JPEG
Video Stream	Main Stream, Sub Stream
Main Stream Resolution	1920x1080, 1280x720, 1024x576
Sub Stream Resolution	720x576, 720x480, 320x240
Video Bit Rate	128Kbps ~ 8192Kbps
Bit Rate Type	Variable Rate, Fixed Rate
Frame Rate	50Hz: 1fps ~ 50fps, 60Hz: 1fps ~ 60fps
Audio Compression	AAC
Audio Bit Rate	96Kbps, 128Kbps, 256Kbps
Support Protocols	TCP/IP, HTTP, RTSP, RTMP, DHCP, Multicast, etc.
General Specifications	
Power Connector	JEITA type (DC IN 12V) or RJ45 via PoE 802.3af
Input Voltage	12VDC (10.8 - 13.0V DC)
Current Consumption	1.0A (Max)
Operating Temperature	23°F - 104°F [-5°C - 40°C]
Storage Temperature	-4°F - 140°F [-20°C - 60°C]
Power Consumption	12W (Max)
Dimensions (w x h x d)	5.56" x 6.63" (7.25" full vertical tilt) x 5.88" [142mm x 169mm (185mm full vertical tilt) x 150mm]
Weight	3.1 lbs. [1.41kg]

Main Unit

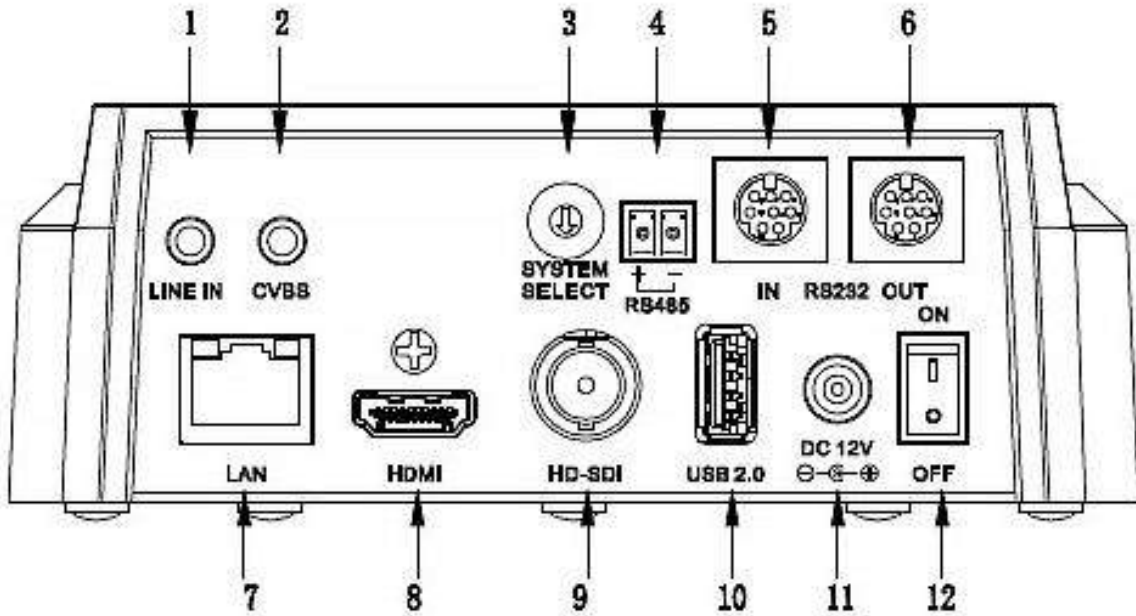

- | | |
|--|---|
| 1. Audio LINE IN Interface (IP Stream & HDMI only) | 7. Network (IP streaming and control) |
| 2. CVBS (composite video SD) Interface | 8. HDMI 1.3 (Digital Video Output) |
| 3. System select dial (resolution) | 9. 3G-SDI (Serial Digital Video Output) |
| 4. RS485 jack | 10. USB 2.0 (*no video out* Future - USB Storage) |
| 5. RS232 IN jack | 11. DC 12V power jack |
| 6. RS232 OUT jack (pass through for daisy chain) | 12. Power switch |

IR Remote Controller

1. Standby Button

Press this button to enter standby mode. Press it again to enter normal mode.

NOTE: Power consumption in standby mode is approximately half of the normal mode.

2. Position Buttons

To set preset or call preset.

3. * Button

For multiple function.

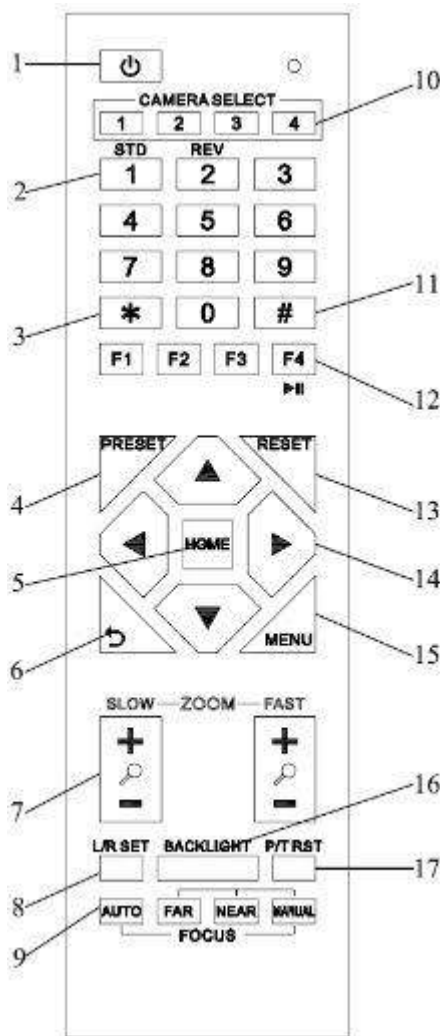

4&13. Set/Clear Preset Buttons

Set preset: Store a preset position

[PRESET] + Numeric button (0-9): Setting a corresponding numeric key preset position

NOTE: Preset 0 - 9 via remote control and the rest from web, keyboard and the serial port.

Clear preset: Erase a preset position [RESET] + Numeric button (0-9), or: [*] + [#] + [RESET]: Erase all presets

5&14. Pan/Tilt Control Buttons

Press the arrow buttons to perform panning and tilting. Press the [HOME] button to face the camera back to front.

6. Return Button

Press the button to back previous menu.

7. Zoom Buttons

Zoom+: Zoom In (Slow and fast speed)

Zoom-: Zoom Out (Slow and fast speed)

8. L/R Set Button

Set the left & right direction of the remote control.

[L/R Set] + [1]: Normal direction.

[L/R Set] + [2]: Left and right direction will be reversed.

9. Focus Buttons

Used for focus adjustment.

Press [AUTO] to adjust the focus on the center of the object automatically. To adjust the focus manually, press the [MANUAL] button, and adjust it with [Far] (focus on far object) and [Near] (focus on near object).

10. Camera Address Select Buttons

Press the button corresponding to the camera which you want to operate with the remote controller.

11. # Button

For multiple function.

12. Multiple Function Buttons

Function 1. Set camera IR address

Press 3 keys contiguously can set camera IR address as follow:

[*] + [#] + [F1]: Address 1

[*] + [#] + [F2]: Address 2

[*] + [#] + [F3]: Address 3

[*] + [#] + [F4]: Address 4

Function 2. Image freezing function

Press [F4] to start the freeze function. The word "Freeze" displays on the upper left corner. After five seconds, the display disappears automatically (though the freeze feature continues). To cancel the freeze, press the [F4] key the word "Unfreeze" displays on the upper left corner. After five seconds, the display disappears automatically.

15. Menu Setting

Menu button: Press this button to enter or exit the OSD menu.

16. Backlight Button

Backlight button: Press this button to enable the backlight compensation. Press it again to disable the backlight compensation.

NOTE: Effective only in auto exposure mode.

NOTE: If there is a light behind the subject, the subject will appear dark. In this case, press the backlight ON / OFF button. To cancel this function, press the backlight ON / OFF button.

17. P/T RST Button

Press the button to self-calibrate pan and tilt once again.

Shortcuts for some 'Set' Functions

[*] + [#] + [1]: Display OSD menu in English

[*] + [#] + [3]: Display OSD menu in Chinese

[*] + [#] + [4]: Show IP address

[*] + [#] + [6]: Quickly restore the default settings

[*] + [#] + [8]: Show the camera version

[*] + [#] + [9]: Quickly set mount mode (flip / normal)1. Standby Button

Press this button to enter standby mode. Press it again to enter normal mode.

NOTE: Power consumption in standby mode is approximately half of the normal mode.

Using the IR Remote Controller

When the camera is operational, you can use the remote controller to perform panning, tilting, zooming and focusing, as well as store and call back preset positions.

Button Instructions:

1. In these instructions, 'press the button' means to press and release. A special note will be given if holding a button down for more than one second is required.

2. When a button-combination is required, do it in sequence (not simultaneously). For example, '[*] + [#] + [F1]' means press [*] first and then press [#] and then press [F1].

1. Pan/Tilt Control

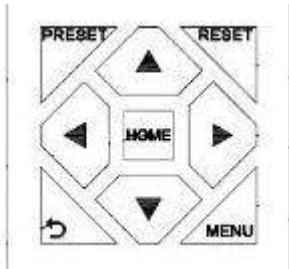

Tilt up:	Press [▲]
Tilt down:	Press [▼]
Pan left:	Press [◀]
Pan right:	Press [▶]
Face the camera back to front:	Press [HOME]

Press and hold the up/down/left/right buttons, to keep panning or tilting from slow to fast, (until the camera reaches the mechanical limit). The camera stops as soon as the button is released.

2. Zoom Control

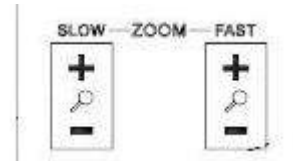

Zoom Out: press [+] button under FAST or SLOW

Zoom In: press [-] button under FAST or SLOW

Press and hold the button, to keep zooming in or out (until the lens reaches the mechanical limit). The lens stops as soon as the button is released.

3. Focus Control

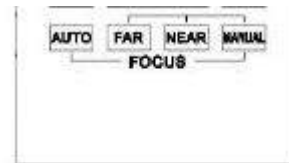

AUTO: Change focus mode to AF, which allows the camera to adjust the focus automatically on the center of the image.

MANUAL: Change focus mode to MF, which allows the user to adjust the focus manually (see FOCUS FAR & FOCUS NEAR).

FOCUS FAR: Press [FAR] button (NOTE: Effective only in MANUAL focus mode)

FOCUS NEAR: Press [NEAR] button (NOTE: Effective only in MANUAL focus mode)

Press and hold the FOCUS [FAR] or FOCUS [NEAR] button, allows for continuous adjustment, stopping as soon as the button is released.

4. BACKLIGHT. L/R SET and P/T RST Controls

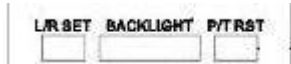

Reverse Pan controls direction: Press and hold [L/R SET] button while pressing [1] aka [STD] button for normal pan controls. Press and hold [L/R SET] button while pressing [2] aka [REV] button for reversed pan controls.

Backlight Compensation Control: Press [BACKLIGHT] button to enable backlight compensation. Press it again to disable backlight compensation. (Note: Backlight is only effective in full auto exposure mode)

Pan Tilt Control Self Calibration: Press [P/T RST] button to recalibrate the Pan and Tilt limits.

5. Standby Control



Press [⏻] button to put camera in 'standby' mode. In standby mode the camera will provide no image, respond to no commands and use less than half its normal power. Press [⏻] button again to put camera in normal mode.

6. Presets - Setting and Clearing

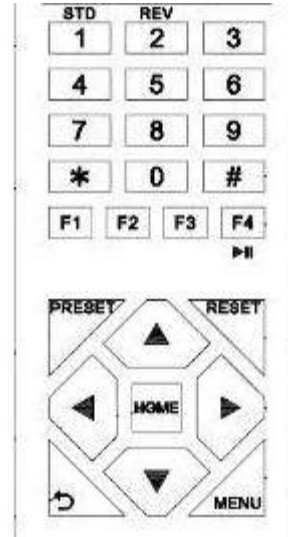

1. To store a preset position: The user should manually setup the desired shot using the Pan Tilt and Zoom controls. Press the [PRESET] button first and then press the numeric button [0-9] to which you want to assign the shot. Ten total preset positions (0-9) are available from the IR remote control (255 available via RS232/RS485/IP Interfaces).

2. To erase the memory content of a preset position: The user should press the [RESET] button first and then press the numeric button 0-9 associated with that preset.

Note:

Pressing [*] + [#] + [RESET] in sequence will erase all presets in the memory.

7. Recalling Presets



Pressing any of the numeric buttons [0-9] directly will recall a stored preset position and settings.

Note:

No action will be executed if a specific numeric preset position has not yet been saved.

Note:

Presets assigned via the IP interface do not correlate to presets set via the IR remote control.

8. Camera Selection

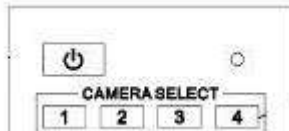

Press the [1-4] button corresponding to the camera with the IR address that you want to operate. This allows for up to 4 cameras to be operated via the same IR remote in the same room.

9. Camera IR Address Set



Press 3 buttons in the sequence shown below to set/change the camera's IR address. This allows up to 4 cameras to be controlled from the same IR remote control. Be sure that only one camera is picking up the IR signal when you perform this function. If multiple cameras receive the command, they will all change to the new address.

Address 1: [*] + [#] + [F1]

Address 2: [*] + [#] + [F2]

Address 3: [*] + [#] + [F3]

Address 4: [*] + [#] + [F4]

10. Image Freeze



Press the [] button to freeze or unfreeze the video image. This can be useful while recalling presets to hide camera motion from your viewers.

Dimensional Drawings (mm)

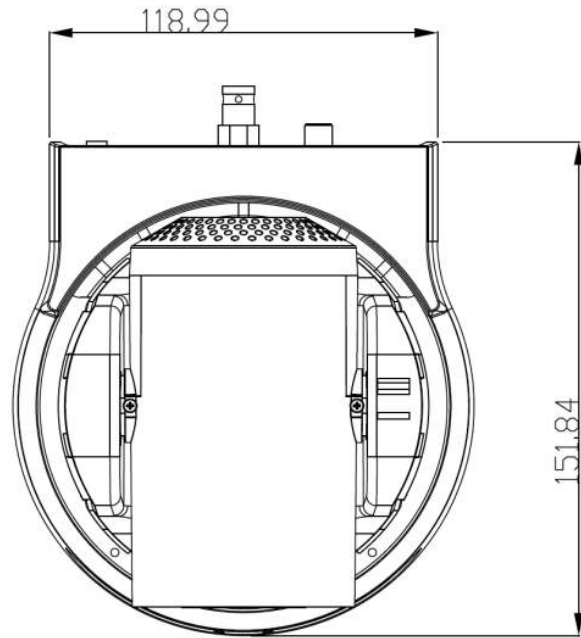
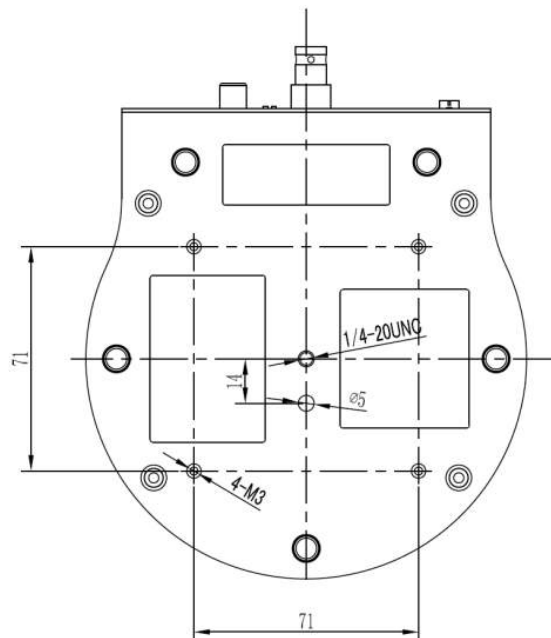
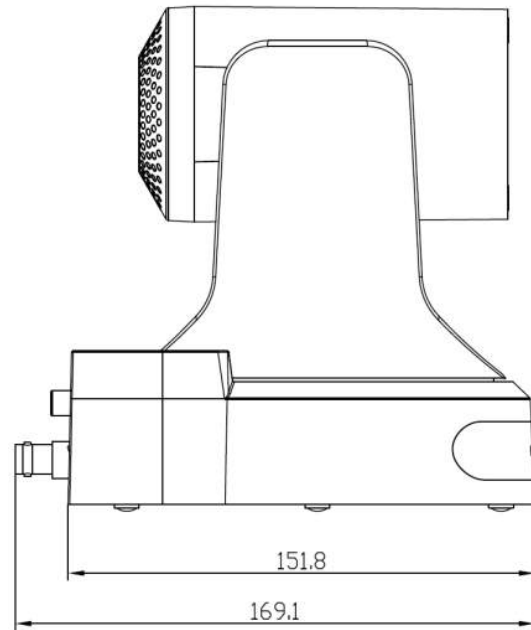
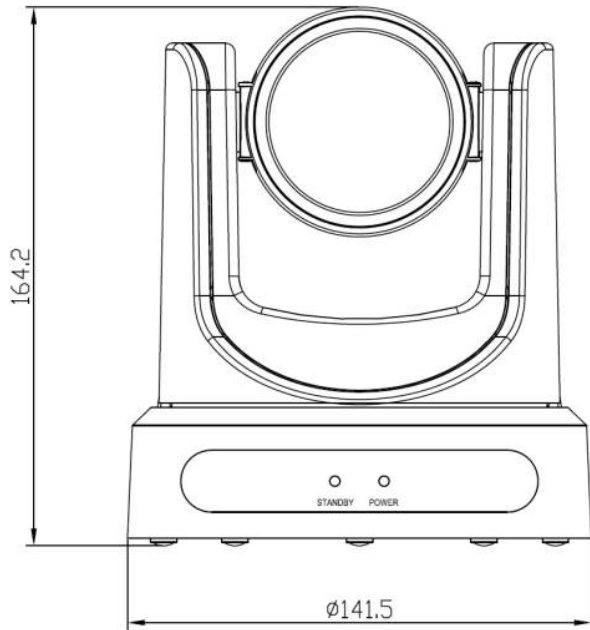

RS-232 Interface

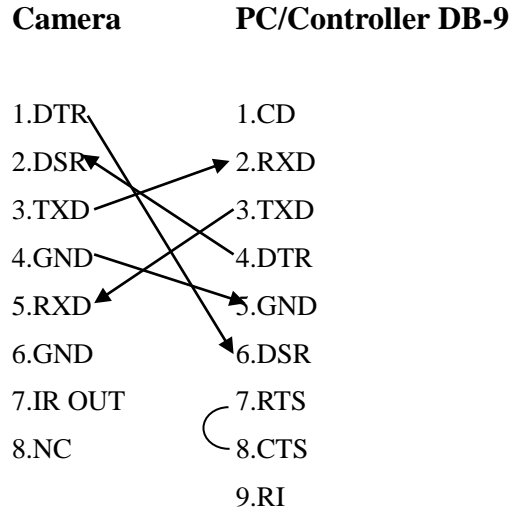
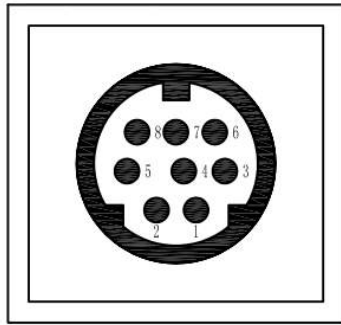

No.	Function
1	DTR
2	DSR
3	TXD
4	GND
5	RXD
6	GND
7	IR OUT
8	NC

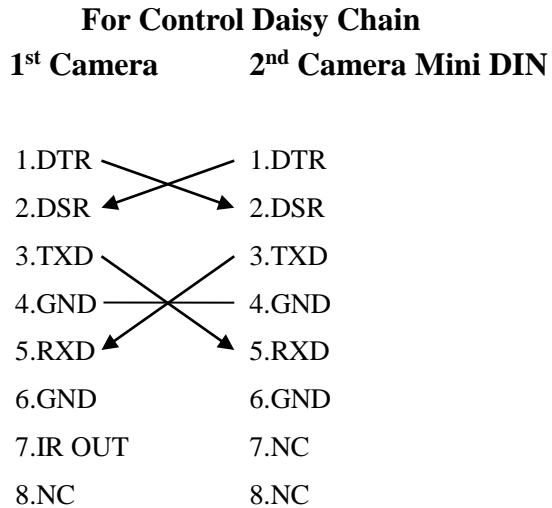

Serial Communication Control

In default working mode, the camera is able to connect to a VISCA controller with an RS232C serial interface.

➤ RS232 Communication Control

The camera can be controlled via RS232. The parameters of RS232C are as follows:

Baud rate: 2400, 4800 or 9600 bps.

Start bit: 1 bit.

Data bit: 8 bits.

Stop bit: 1 bit.

Parity bit: none.

➤ RS485 Communication Control

The camera can be controlled via RS485, Half-duplex mode, with support for VISCA, Pelco-D or Pelco-P protocol.

The parameters of RS485 are as follows:

Baud rate: 2400, 4800 or 9600 bps.

Start bit: 1 bit.

Data bit: 8 bits.

Stop bit: 1 bit.

Parity bit: none.

When powered on, Pan and Tilt will rotate to the maximum position of top right after the camera powered up. Then it will return to the “center”. The process of initialization is now complete. (Note: If the position preset 0 has been stored, the position preset 0 will be called up after initialization, in lieu of “center”). After initialization is complete, then the user can control the camera with commands in the command list.

VISCA Command List

Part 1: Camera-Issued Messages

ACK/Completion Message			
Command	Function	Command Packet	Comments
ACK/Completion Messages	ACK	z0 4y FF (y: Socket No.)	Returned when the command is accepted.
	Completion	z0 5y FF (y: Socket No.)	Returned when the command has been executed.

z = Camera Address + 8

Error Messages			
Command	Function	Command Packet	Comments
Error Messages	Syntax Error	z0 60 02 FF	Returned when the command format is different or when a command with illegal command parameters is accepted.
	Command Buffer Full	z0 60 03 FF	Indicates that two sockets are already being used (executing two commands) and the command could not be accepted when received.
	Command Canceled	z0 6y 04 FF (y: Socket No.)	Returned when a command which is being executed in a socket specified by the cancel command is canceled. The completion message for the command is not returned.
	No Socket	z0 6y 05 FF (y: Socket No.)	Returned when no command is executed in a socket specified by the cancel command, or when an invalid socket number is specified.
	Command Not Executable	z0 6y 41 FF (y: Execution command Socket No. Inquiry command: 0)	Returned when a command cannot be executed due to current conditions. For example, when commands controlling the focus manually are received during auto focus.

Part 2: Camera Control Commands

Command	Function	Command Packet	Comments
AddressSet	Broadcast	88 30 01 FF	Address setting
IF_Clear	Broadcast	88 01 00 01 FF	I/F Clear
CAM_Power	On	8x 01 04 00 02 FF	Power ON/OFF
	Off	8x 01 04 00 03 FF	
CAM_Zoom	Stop	8x 01 04 07 00 FF	
	Tele(Standard)	8x 01 04 07 02 FF	
	Wide(Standard)	8x 01 04 07 03 FF	
	Tele(Variable)	8x 01 04 07 2p FF	p = 0(low) - 7(high)
	Wide(Variable)	8x 01 04 07 3p FF	
	Direct	8x 01 04 47 0p 0q 0r 0s FF	pqrs: Zoom Position
CAM_Focus	Stop	8x 01 04 08 00 FF	
	Far(Standard)	8x 01 04 08 02 FF	
	Near(Standard)	8x 01 04 08 03 FF	
	Far(Variable)	8x 01 04 08 2p FF	p = 0(low) - 7(high)
	Near(Variable)	8x 01 04 08 3p FF	
	Direct	8x 01 04 48 0p 0q 0r 0s FF	pqrs: Focus Position
	Auto Focus	8x 01 04 38 02 FF	AF On/Off
	Manual Focus	8x 01 04 38 03 FF	
	Auto/Manual	8x 01 04 38 10 FF	
CAM_ZoomFocus	Direct	8x 01 04 47 0p 0q 0r 0s 0t 0u 0v 0w FF	pqrs: Zoom Position tuvw: Focus Position
CAM_WB	Auto	8x 01 04 35 00 FF	Normal Auto
	Indoor mode	8x 01 04 35 01 FF	Indoor mode
	Outdoor mode	8x 01 04 35 02 FF	Outdoor mode
	OnePush mode	8x 01 04 35 03 FF	One Push WB mode
	Manual	8x 01 04 35 05 FF	Manual Control mode
	OnePush trigger	8x 01 04 10 05 FF	One Push WB Trigger
CAM_RGain	Reset	8x 01 04 03 00 FF	Manual Control of R Gain
	Up	8x 01 04 03 02 FF	
	Down	8x 01 04 03 03 FF	
	Direct	8x 01 04 43 00 00 0p 0q FF	pq: R Gain
CAM_Bgain	Reset	8x 01 04 04 00 FF	Manual Control of B Gain
	Up	8x 01 04 04 02 FF	
	Down	8x 01 04 04 03 FF	
	Direct	8x 01 04 44 00 00 0p 0q FF	pq: B Gain



broadcast quality made affordable

CAM_AE	Full Auto	8x 01 04 39 00 FF	Automatic Exposure mode
	Manual	8x 01 04 39 03 FF	Manual Control mode
	Shutter priority	8x 01 04 39 0A FF	Shutter Priority Automatic Exposure mode
	Iris priority	8x 01 04 39 0B FF	Iris Priority Automatic Exposure mode
	Bright	8x 01 04 39 0D FF	Bright Mode(Manual control)
CAM_SlowShutter	AutoSlowShutterLimit	8x 01 04 2A 0p 00 FF	
CAM_Iris	Reset	8x 01 04 0B 00 FF	Iris Setting
	Up	8x 01 04 0B 02 FF	
	Down	8x 01 04 0B 03 FF	
	Direct	8x 01 04 4B 00 00 0p 0q FF	pq: Iris Position
CAM_Gain	Reset	8x 01 04 0C 00 FF	Gain Setting
	Up	8x 01 04 0C 02 FF	
	Down	8x 01 04 0C 03 FF	
	Direct	8x 01 04 0C 00 00 0p 0q FF	pq: Gain Position
	Gain Limit	8x 01 04 2C 0p FF	p: Gain Position
CAM_Bright	Reset	8x 01 04 0D 00 FF	Bright Setting
	Up	8x 01 04 0D 02 FF	
	Down	8x 01 04 0D 03 FF	
	Direct	8x 01 04 0D 00 00 0p 0q FF	pq: Bright Position
CAM_ExpComp	On	8x 01 04 3E 02 FF	Exposure Compensation On/Off
	Off	8x 01 04 3E 03 FF	
	Reset	8x 01 04 0E 00 FF	Exposure Compensation Amount Setting
	Up	8x 01 04 0E 02 FF	
	Down	8x 01 04 0E 03 FF	
	Direct	8x 01 04 4E 00 00 0p 0q FF	
CAM_BackLight	On	8x 01 04 33 02 FF	Back Light Compensation On/Off
	Off	8x 01 04 33 03 FF	
CAM_NR(2D)Mode	Auto	8x 01 04 50 02 FF	ND2D Auto/Manual
	Manual	8x 01 04 50 03 FF	
CAM_NR(2D)Level	-	8x 01 04 53 0p FF	p: NR Setting (0: Off, level 1 to 5)
CAM_NR(3D)Level	-	8x 01 04 54 0p FF	p: NR Setting (0: Off, level 1 to 8)
CAM_Flicker	-	8x 01 04 23 0p FF	p: Flicker Settings (0: Off, 1: 50Hz, 2: 60Hz)
CAM_DHotPixel	-	8x 01 04 56 0p FF	p: Dynamic Hot Pixel Setting (0: Off, level 1 to 6)
CAM_ApertureMode(sharpness)	Auto	8x 01 04 05 02 FF	Sharpness Auto

	Manual	8x 01 04 05 02 FF	Sharpness Manual
CAM_Aperture(sharpness)	Reset	8x 01 04 02 00 FF	Aperture Control
	Up	8x 01 04 02 02 FF	
	Down	8x 01 04 02 03 FF	
	Direct	8x 01 04 42 00 00 0p 0q FF	pq: Aperture Gain
CAM_PictureEffect	Off	8x 01 04 63 00 FF	Picture Effect Setting
	B&W	8x 01 04 63 04 FF	
CAM_Memory	Reset	8x 01 04 3F 00 pp FF	pp: Memory Number(=0 to 127)
	Set	8x 01 04 3F 01 pp FF	
	Recall	8x 01 04 3F 02 pp FF	
CAM_LR_Reverse	On	8x 01 04 61 02 FF	Image Flip Horizontal On/Off
	Off	8x 01 04 61 03 FF	
CAM_PictureFlip	On	8x 01 04 66 02 FF	Image Flip Vertical On/Off
	Off	8x 01 04 66 03 FF	
CAM_RegisterValue	-	8x 01 04 24 mn 0p 0q FF	mm: Register No. (=00-7F) pp: Register Value (=00-7F)
CAM_ColorGain	Diret	8x 01 04 49 00 00 00 0p FF	p: Color Gain setting 0h (60%) to Eh (200%)
SYS_Menu	Off	8x 01 06 06 03 FF	Turns off the menu screen
Pan_tiltDrive	Up	8x 01 06 01 VV WW 03 01 FF	VV: Pan speed 0x01 (low speed) to 0x18 (high speed) WW: Tilt speed 0x01 (low speed) to 0x14 (high speed) YYYY: Pan Position ZZZZ: Tilt Position
	Down	8x 01 06 01 VV WW 03 02 FF	
	Left	8x 01 06 01 VV WW 01 03 FF	
	Right	8x 01 06 01 VV WW 02 03 FF	
	Upleft	8x 01 06 01 VV WW 01 01 FF	
	Upright	8x 01 06 01 VV WW 02 01 FF	
	DownLeft	8x 01 06 01 VV WW 01 02 FF	
	DownRight	8x 01 06 01 VV WW 02 02 FF	
	Stop	8x 01 06 01 VV WW 03 03 FF	
	AbsolutePosition	8x 01 06 02 VV WW 0Y 0Y 0Y 0Y 0Z 0Z 0Z 0Z FF	
	RelativePosition	8x 01 06 03 VV WW 0Y 0Y 0Y 0Y 0Z 0Z 0Z 0Z FF	
	Home	8x 01 06 04 FF	
	Reset	8x 01 06 05 FF	
Pan_tiltLimitSet	LimitSet	8x 01 06 07 00 0W 0Y 0Y 0Y 0Y 0Z 0Z 0Z 0Z FF	W: 1 UpRight 0: DownLeft YYYY: Pan Limit Position ZZZZ: Tilt Position
	LimitClear	8x 01 06 07 01 0W 07 0F 0F 0F 07 0F 0F 0F FF	

CAM_AFSensitivity	High	8x 01 04 58 01 FF	AF Sensitivity High/Normal/Low
	Normal	8x 01 04 58 02 FF	
	Low	8x 01 04 58 03 FF	
CAM_SettingReset	Reset	8x 01 04 A0 10 FF	Reset Factory Setting
CAM_Brightness	Direct	8x 01 04 A1 00 00 0p 0q FF	pq: Brightness Position
CAM_Contrast	Direct	8x 01 04 A2 00 00 0p 0q FF	pq: Contrast Position
CAM_Flip	Off	8x 01 04 A4 00 FF	Single Command For Video Flip
	Flip-H	8x 01 04 A4 01 FF	
	Flip-V	8x 01 04 A4 02 FF	
	Flip-HV	8x 01 04 A4 03 FF	
CAM_SettingSave	Save	8x 01 04 A5 10 FF	Save Current Setting
CAM_Iridix	Direct	8x 01 04 A7 00 00 0p 0q FF	pq: Iridix Position
CAM_AWBSensitivity	High	8x 01 04 A9 00 FF	High
	Normal	8x 01 04 A9 01 FF	Normal
	Low	8x 01 04 A9 02 FF	Low
CAM_AFZone	Top	8x 01 04 AA 00 FF	AF Zone weight select
	Center	8x 01 04 AA 01 FF	
	Bottom	8x 01 04 AA 02 FF	
CAM_ColorHue	Direct	8x 01 04 4F 00 00 00 0p FF	p: Color Hue setting 0h (– 14 degrees) to Eh (+14 degrees)

Part 3: Query Commands

Inquiry Command List			
Command	Command packed	Inquiry Packet	Comments
CAM_PowerInq	8x 09 04 00 FF	y0 50 02 FF	On
		y0 50 03 FF	Off(Standby)
		y0 50 04 FF	Internal power circuit error
CAM_ZoomPosInq	8x 09 04 47 FF	y0 50 0p 0q 0r 0s FF	pqrs: Zoom Position
CAM_FocusAFMode Inq	8x 09 04 38 FF	y0 50 02 FF	Auto Focus
		y0 50 03 FF	Manual Focus
CAM_FocusPosInq	8x 09 04 48 FF	y0 50 0p 0q 0r 0s FF	pqrs: Focus Position
CAM_WBModeInq	8x 09 04 35 FF	y0 50 00 FF	Auto
		y0 50 01 FF	Indoor mode
		y0 50 02 FF	Outdoor mode
		y0 50 03 FF	OnePush mode
		y0 50 05 FF	Manual
CAM_RGainInq	8x 09 04 43 FF	y0 50 00 00 0p 0q FF	pq: R Gain
CAM_BGainInq	8x 09 04 44 FF	y0 50 00 00 0p 0q FF	pq: B Gain
CAM_AEModeInq	8x 09 04 39 FF	y0 50 00 FF	Full Auto
		y0 50 03 FF	Manual
		y0 50 0A FF	Shutter priority
		y0 50 0B FF	Iris priority
		y0 50 0D FF	Bright
CAM_ShutterPosInq	8x 09 04 4A FF	y0 50 00 00 0p 0q FF	pq: Shutter Position
CAM_IrisPosInq	8x 09 04 4B FF	y0 50 00 00 0p 0q FF	pq: Iris Position
CAM_BrightPosInq	8x 09 04 4D FF	y0 50 00 00 0p 0q FF	pq: Bright Position
CAM_ExpCompModeInq	8x 09 04 3E FF	y0 50 02 FF	On
		y0 50 03 FF	Off
CAM_ExpCompPosInq	8x 09 04 4E FF	y0 50 00 00 0p 0q FF	pq: ExpComp Position
CAM_BacklightMode Inq	8x 09 04 33 FF	y0 50 02 FF	On
		y0 50 03 FF	Off
CAM_Nosise2DMode Ing	8x 09 04 50 FF	y0 50 02 FF	Auto Noise 2D
		y0 50 03 FF	Manual Noise 3D
CAM_Nosise2DLevel	8x 09 04 53 FF	y0 50 0p FF	Noise Reduction (2D) p: 0 to 5
CAM_Noise3DLevel	8x 09 04 54 FF	y0 50 0p FF	Noise Reduction (3D) p: 0 to 8
CAM_FlickerModeInq	8x 09 04 55 FF	y0 50 0p FF	p: Flicker Settings(0: OFF, 1: 50Hz, 2: 60Hz)



broadcast quality made affordable

CAM_ApertureModelInq(Sharpness)	8x 09 04 05 FF	y0 50 02 FF	Auto Sharpness
		y0 50 03 FF	Manual Sharpness
CAM_ApertureInq(Sharpness)	8x 09 04 42 FF	y0 50 00 00 0p 0q FF	pq: Aperture Gain
CAM_PictureEffectModeInq	8x 09 04 63 FF	y0 50 02 FF	Off
		y0 50 04 FF	B&W
CAM_MemoryInq	8x 09 04 3F FF	y0 50 0p FF	p: Memory number last operated.
SYS_MenuModeInq	8x 09 06 06 FF	y0 50 02 FF	On
		y0 50 03 FF	Off
CAM_LR_ReverseInq	8x 09 04 61 FF	y0 50 02 FF	On
		y0 50 03 FF	Off
CAM_PictureFlipInq	8x 09 04 66 FF	y0 50 02 FF	On
		y0 50 03 FF	Off
CAM_RegisterValueInq	8x 09 04 24 mm FF	y0 50 0p 0p ff	mm: Register No. (00 to FF) pp: Register Value (00 to FF)
CAM_ColorGainInq	8x 09 04 49 FF	y0 50 00 00 00 0p FF	p: Color Gain setting 0h (60%) to Eh (200%)
CAM_IDInq	8x 09 04 22 FF	y0 50 0p 0q 0r 0s FF	pqrs: Camera ID
CAM_VersionInq	8x 09 00 02 FF	y0 50 ab cd mn pq rs tu vw FF	ab: Factory Code(00: VHD, 01:MR, 08:T) cd: Hardware Version mnpq: ARM Version rstu: FPGA Version vw: Camera model 01: C Type 02: M Type 03: S Type
VideoSystemInq	8x 09 06 23 FF	y0 50 00 FF	1920x1080i60
		y0 50 01 FF	1920x1080p30
		y0 50 02 FF	1280x720p60
		y0 50 04 FF	NTSC
		y0 50 05 FF	NTSC
		y0 50 06 FF	NTSC
		y0 50 07 FF	1920x1080p60
		y0 50 08 FF	1920x1080i50
		y0 50 09 FF	1920x1080p25
		y0 50 0A FF	1280x720p50



broadcast quality made affordable

		y0 50 0C FF	PAL
		y0 50 0D FF	PAL
		y0 50 0E FF	PAL
IR_Receive	8x 09 06 08 FF	y0 50 02 FF	On
		y0 50 03 FF	Off
Pan-tiltMaxSpeedInq	8x 09 06 11 FF	y0 50 ww zz FF	ww: Pan Max Speed zz: Tilt Max Speed
Pan-tiltPosInq	8x 09 06 12 FF	y0 50 0w 0w 0w 0w 0z 0z 0z 0z FF	www: Pan Position zzzz: Tilt Position
CAM_TypeInq	8x 09 00 03 FF	y0 50 01 FF	C Type
		y0 50 02 FF	M Type
		y0 50 03 FF	S Type
CAM_DateInq	8x 09 00 04 FF	y0 50 0r ss uu vv ww 0D FF	Version dater: Big Version Numbers: Little Version Numberuuuu: Yearvv: Monthww: Day
CAM_ModeInq	8x 09 04 A6 FF	y0 50 00 FF	Mode0
		y0 50 02 FF	Mode2
CAM_GainLimitInq	8x 09 04 2C FF	y0 50 0q FF	p: Gain Limit
CAM_DHotPixelInq	8x 09 04 56 FF	y0 50 0q FF	p: Dynamic Hot Pixel Setting (0: Off, level 1 to 6)
CAM_AFSensitivityInq	8x 09 04 58 FF	y0 50 01 FF	High
		y0 50 02 FF	Normal
		y0 50 03 FF	Low
CAM_BrightnessInq	8x 09 04 A1 FF	y0 50 00 00 0p 0q FF	pq: Brightness Position
CAM_ContrastInq	8x 09 04 A2 FF	y0 50 00 00 0p 0q FF	pq: Contrast Position
CAM_FlipInq	8x 09 04 A4 FF	y0 50 00 FF	Off
		y0 50 01 FF	Flip-H
		y0 50 02 FF	Flip-V
		y0 50 03 FF	Flip-HV
CAM_IridixInq	8x 09 04 A7 FF	y0 50 00 00 0p 0q FF	pq: Iridix Position
CAM_AFZone	8x 09 04 AA FF	y0 50 00 FF	Top
		y0 50 01 FF	Center
		y0 50 02 FF	Bottom
CAM_ColorHueInq	8x 09 04 4F FF	y0 50 00 00 00 0p FF	p: Color Hue setting 0h (- 14 degrees) to Eh (+14 degrees)
CAM_AWBSensitivityInq	8x 09 04 A9 FF	y0 50 00 FF	High
		y0 50 01 FF	Normal
		y0 50 02 FF	Low

Block Inquiry Command List			
Command	Command packed	Inquiry Packet	Comments
CAM_LensBlockInq	8x 09 7E 7E 00 FF	y0 50 0u 0u 0u 0u 00 00 0v 0v 0v 0v 00 0w 00 FF	uuuu: Zoom Position vvvv: Focus Position w.bit0: Focus Mode 1: Auto 0: Manual
CAM_CameraBlockInq	8x 09 7E 7E 01 FF	y0 50 0p 0p 0q 0q 0r 0s tt 0u vv ww 00 xx 0z FF	pp: R_Gain qq: B_Gain r: WB Mode s: Aperture tt: AE Mode u.bit2: Back Light u.bit1: Exposure Comp. vv: Shutter Position ww: Iris Position xx: Bright Position z: Exposure Comp. Position
CAM_OtherBlockInq	8x 09 7E 7E 02 FF	y0 50 0p 0q 00 0r 00 00 00 00 00 00 00 00 00 FF	p.bit0: Power 1:On, 0:Off q.bit2: LR Reverse 1:On, 0:Off r.bit3~0: Picture Effect Mode
CAM_EnlargementBlockInq	8x 09 7E 7E 03 FF	y0 50 00 00 00 00 00 00 0p 0q rr 0s 0t 0u FF	p: AF sensitivity q.bit0: Picture flip(1:On, 0:Off) rr.bit6~3: Color Gain(0h(60%) to Eh(200%)) s: Flip(0: Off, 1:Flip-H, 2:Flip-V, 3:Flip-HV) t.bit2~0: NR2D Level u: Gain Limit

Note:

The [x] in the above table is the camera address, [y] = [x + 8].

VISCA over IP Command List

Command	Function	Command Packet	Comments
CAM_Zoom	Stop	81 01 04 07 00 FF	
	Tele (Standard)	81 01 04 07 02 FF	
	Wide (Standard)	81 01 04 07 03 FF	
	Tele (Variable)	81 01 04 07 2p FF	p = (low) – 7 (high)
	Wide (Variable)	81 01 04 07 3p FF	
	Direct	81 01 04 47 p q r s FF	pqrs: Zoom Position
CAM_Focus	Stop	81 01 04 08 00 FF	
	Far (Standard)	81 01 04 08 02 FF	
	Near (Standard)	81 01 04 08 03 FF	
	Far (Variable)	81 01 04 08 2p FF	p = (low) – 7 (high)
	Near (Variable)	81 01 04 08 3p FF	
	Direct	81 01 04 48 p q r s FF	pqrs: Focus Position
	Auto Focus	81 01 04 38 02 FF	
	Manual Focus	81 01 04 38 03 FF	
	Auto/Manual Toggle	81 01 04 38 10 FF	
	Focus Lock	81 0a 04 68 02 FF	Prevents any other operation or command from adjusting the current focus state
	Focus Unlock	81 0a 04 68 03 FF	
CAM_WB	Auto	81 01 04 35 00 FF	Normal Auto
	Indoor Mode	81 01 04 35 01 FF	Indoor Mode
	Outdoor Mode	81 01 04 35 02 FF	Outdoor Mode
	OnePush Mode	81 01 04 35 03 FF	OnePush WB Mode
	Manual	81 01 04 35 05 FF	Manual Control Mode
	OnePush Trigger	81 01 04 10 05 FF	OnePush WB Trigger
CAM_RGain	Reset	81 01 04 03 00 FF	Manual Control of R Gain
	Up	81 01 04 03 02 FF	
	Down	81 01 04 03 03 FF	
	Direct	81 01 04 43 00 00 p q FF	pq: R Gain
CAM_BGain	Reset	81 01 04 04 00 FF	Manual Control of B Gain
	Up	81 01 04 04 02 FF	
	Down	81 01 04 04 03 FF	
	Reset	81 01 04 44 00 00 p q FF	pq: B Gain
CAM_AE	Full auto	81 01 04 39 00 FF	Automatic Exposure mode
	Manual	81 01 04 39 03 FF	Manual Control mode
	Shutter Priority	81 01 04 39 0A FF	Shutter Priority Automatic Exposure mode
	Iris Priority	81 01 04 39 0B FF	Iris Priority Automatic Exposure mode
	Bright	81 01 04 39 0D FF	Bright Mode (Manual control)



broadcast quality made affordable

CAM_Iris	Reset	81 01 04 0B 00 FF	Iris Setting pq: Iris Position
	Up	81 01 04 0B 02 FF	
	Down	81 01 04 0B 03 FF	
	Direct	81 01 04 4B 00 00 p q FF	
CAM_Shutter	Reset	81 01 04 0A 00 FF	Default Shutter Setting
	Up	81 01 04 0A 02 FF	pq: Shutter Position
	Down	81 01 04 0A 03 FF	
	Direct	81 01 04 4A 00 00 p q FF	
CAM_Backlight	On	81 01 04 33 02 FF	
	Off	81 01 04 33 03 FF	
CAM_Flicker	-	81 01 04 23 0p FF	p: Flicker Settings – (0: Off, 1: 50Hz, 2: 60Hz)
CAM_PictureEffect	Off	81 01 04 63 00 FF	Picture Effect Setting
	B&W	81 01 04 63 04 FF	
CAM_Memory	Reset	81 01 04 3F 00 pp FF	pp: Memory Number(Hex 0,0 – 3,F)
	Set	81 01 04 3F 01 pp FF	
	Recall	81 01 04 3F 02 pp FF	
Preset Recall Speed	Preset Speed	81 01 06 01 p FF	p: is speed grade,the values are (0x1~0x18)
CAM_LR_Reverse	On	81 01 04 61 02 FF	Image Flip Horizontal On/Off
	Off	81 01 04 61 03 FF	
CAM_PictureFlip	On	81 01 04 66 02 FF	Image Flip Vertical On/Off
	Off	81 01 04 66 03 FF	
Pan Tilt Drive	Up	81 01 06 01 VV WW 03 01 FF	VV: Pan Speed 0x01 (Low) to 0x18 (high) WW: Tilt Speed 0x01 (Low) to 0x18 (high)
	Down	81 01 06 01 VV WW 03 02 FF	
	Left	81 01 06 01 VV WW 01 03 FF	
	Right	81 01 06 01 VV WW 02 03 FF	
	Up Left	81 01 06 01 VV WW 01 01 FF	
	Up Right	81 01 06 01 VV WW 02 01 FF	
	Down Left	81 01 06 01 VV WW 01 02 FF	
	Down right	81 01 06 01 VV WW 02 02 FF	
	Stop	81 01 06 01 VV WW 03 03 FF	
	Absolute Position	81 01 06 02 VV WW Y Y Y Y Z Z Z Z FF	YYYY: Pan Position
	Relative Position	81 01 06 03 VV WW Y Y Y Y Z Z Z Z FF	WWWW: Tilt Position
	Home	81 01 06 04 FF	
	Reset	81 01 06 05 FF	
	CAM_Brightness	Direct	81 01 04 A1 00 00 0p 0q FF
CAM_Contrast	Direct	81 01 04 A2 00 00 0p 0q FF	pq: Contrast Position

CAM-Flip	Off	81 01 04 A4 00 FF	Single Command For Video Flip
	Flip-H	81 01 04 A4 01 FF	
	Flip-V	81 01 04 A4 02 FF	
	Flip-HV	81 01 04 A4 03 FF	
CAM_SettingSave	Save	81 01 04 A5 10 FF	Save Current Setting
CAM_AWBSensitivity	High	81 01 04 A9 00 FF	High
	Normal	81 01 04 A9 01 FF	Normal
	Low	81 01 04 A9 02 FF	Low
CAM_AFZone	Top	81 01 04 AA 00 FF	AF Zone priority select
	Center	81 01 04 AA 01 FF	
	Bottom	81 01 04 AA 02 FF	
CAM_ColorHue	Direct	81 01 04 4F 00 00 00 0p FF	p: Color Hue 0h (-14 degrees) to Eh (+14 degrees)
OSD_Control	Open/Close	81 01 04 3F 02 5F FF	

VISCA over IP Query Commands

Command	Command Package	Return Package	Note
CAM_ZoomPosInq	81 09 04 47 FF	90 50 p q r s FF	pqrs: Zoom Position
CAM_FocusAFModeInq	81 09 04 38 FF	90 50 02 FF	Auto Focus
		90 50 03 FF	Manual Focus
CAM_FocusPosInq	81 09 04 48 FF	90 50 0p 0q 0r 0s FF	pqrs: Focus Position
CAM_WBModeInq	81 09 04 35 FF	90 50 00 FF	Auto
		90 50 01 FF	Indoor Mode
		90 50 02 FF	Outdoor Mode
		90 50 03 FF	OnePush Mode
		90 50 05 FF	Manual
CAM_RGainInq	81 09 04 43 FF	90 50 00 00 0p 0q FF	pq: R Gain
CAM_BGainInq	81 09 04 43 FF	90 50 00 00 0p 0q FF	pq: R Gain
CAM_AEModeInq	81 09 04 39 FF	90 50 00 FF	Full Auto
		90 50 03 FF	Manual
		90 50 0A FF	Shutter Priority (SAE)

		90 50 0B FF	Iris Priority (AAE)
		90 50 0D FF	Bright
CAM_ShutterPosInq	81 09 04 4A FF	90 50 00 00 0p 0q FF	pq: Shutter Position
CAM_IrisPosInq	81 09 04 4B FF	90 50 00 00 0p 0q FF	pq: Iris Position
CAM_BrightPosInq	81 09 04 4D FF	90 50 00 00 0p 0q FF	pq: Bright Position
CAM_ExpCompModeInq	81 09 04 3E FF	90 50 02 FF	On
		90 50 03 FF	Off
CAM_ExpCompPosInq	81 09 04 4E FF	90 50 00 00 0p 0q FF	pq: ExpComp Position
CAM_BacklightModeInq	81 09 04 33 FF	90 50 02 FF	On
		90 50 03 FF	Off
CAM_Noise2DModeInq	81 09 04 50 FF	90 50 02 FF	Auto Noise 2D
		90 50 03 FF	Manual Noise 2D
CAM_Noise2DLevel	81 09 04 53 FF	90 50 0p FF	Noise Reduction (2D) p: 0 to 5
CAM_Noise3DLevel	81 09 04 54 FF	90 50 0p FF	Noise Reduction (3D) p: 0 to 8
CAM_FlickerModeInq	81 09 04 55 FF	90 50 0p FF	p: Flicker Settings(0: OFF, 1: 50Hz, 2: 60Hz)
CAM_ApertureModeInq (Sharpness)	81 09 04 05 FF	90 50 02 FF	Auto Sharpness
		90 50 03 FF	Manual Sharpness
CAM_ApertureInq	81 09 04 42 FF	90 50 00 00 0p 0q FF	pq: Aperture Gain
CAM_PictureEffectModeInq	81 09 04 63 FF	90 50 02 FF	Off
		90 50 04 FF	B&W

CAM_LR_ReverseInq	81 09 04 61 FF	90 50 02 FF	On
		90 50 03 FF	Off
CAM_PictureFlipInq	81 09 04 66 FF	90 50 02 FF	On
		90 50 03 FF	Off
CAM_ColorGainInq	81 09 04 49 FF	90 50 00 00 00 0p FF	p: Color Gain setting 0h (60%) to Eh (200%)



broadcast quality made affordable

CAM_PanTiltPosInq	81 09 06 12 FF	90 50 0w 0w 0w 0w	www: Pan Position
		0z 0z 0z 0z FF	zzzz: Tilt Position
CAM_GainLimitInq	81 09 04 2C FF	90 50 0q FF	p: Gain Limit
CAM_BrightnessInq			
CAM_ContrastInq			
CAM_FlipInq	81 09 04 A4 FF	90 50 00 FF	Off
		90 50 01 FF	Flip-H
		90 50 02 FF	Flip-V
		90 50 03 FF	Flip-HV
CAM_AFZone	81 09 04 AA FF	90 50 00 FF	Top
		90 50 01 FF	Center
		90 50 02 FF	Bottom
CAM_ColorHueInq	81 09 04 4F FF	90 50 00 00 00 0p FF	p: Color Hue setting 0h (-14 degrees) to Eh (+14 degrees)
CAM_AWBSensitivityInq	81 09 04 A9 FF	90 50 00 FF	High
		90 50 01 FF	Normal
		90 50 02 FF	Low

Pelco-D Protocol Command List

Function	Byte1	Byte2	Byte3	Byte4	Byte5	Byte6	Byte7
Up	0xFF	Address	0x00	0x08	Pan Speed	Tilt Speed	SUM
Down	0xFF	Address	0x00	0x10	Pan Speed	Tilt Speed	SUM
Left	0xFF	Address	0x00	0x04	Pan Speed	Tilt Speed	SUM
Right	0xFF	Address	0x00	0x02	Pan Speed	Tilt Speed	SUM
Zoom In	0xFF	Address	0x00	0x20	0x00	0x00	SUM
Zoom Out	0xFF	Address	0x00	0x40	0x00	0x00	SUM
Focus Far	0xFF	Address	0x00	0x80	0x00	0x00	SUM
Focus Near	0xFF	Address	0x01	0x00	0x00	0x00	SUM
Set Preset	0xFF	Address	0x00	0x03	0x00	Preset ID	SUM
Clear Preset	0xFF	Address	0x00	0x05	0x00	Preset ID	SUM
Call Preset	0xFF	Address	0x00	0x07	0x00	Preset ID	SUM
Auto Focus	0xFF	Address	0x00	0x2B	0x00	0x01	SUM
Manual Focus	0xFF	Address	0x00	0x2B	0x00	0x02	SUM
Query Pan Position	0xFF	Address	0x00	0x51	0x00	0x00	SUM
Query Pan Position Response	0xFF	Address	0x00	0x59	Value High Byte	Value Low Byte	SUM
Query Tilt Position	0xFF	Address	0x00	0x53	0x00	0x00	SUM
Query Tilt Position Response	0xFF	Address	0x00	0x5B	Value High Byte	Value Low Byte	SUM
Query Zoom Position	0xFF	Address	0x00	0x55	0x00	0x00	SUM
Query Zoom Position Response	0xFF	Address	0x00	0x5D	Value High Byte	Value Low Byte	SUM

Pelco-P Protocol Command List

Function	Byte1	Byte2	Byte3	Byte4	Byte5	Byte6	Byte7	Byte8
Up	0xA0	Address	0x00	0x08	Pan Speed	Tilt Speed	0xAF	XOR
Down	0xA0	Address	0x00	0x10	Pan Speed	Tilt Speed	0xAF	XOR
Left	0xA0	Address	0x00	0x04	Pan Speed	Tilt Speed	0xAF	XOR
Right	0xA0	Address	0x00	0x02	Pan Speed	Tilt Speed	0xAF	XOR
Zoom In	0xA0	Address	0x00	0x20	0x00	0x00	0xAF	XOR
Zoom Out	0xA0	Address	0x00	0x40	0x00	0x00	0xAF	XOR
Focus Far	0xA0	Address	0x00	0x80	0x00	0x00	0xAF	XOR
Focus Near	0xA0	Address	0x01	0x00	0x00	0x00	0xAF	XOR
Set Preset	0xA0	Address	0x00	0x03	0x00	Preset ID	0xAF	XOR
Clear Preset	0xA0	Address	0x00	0x05	0x00	Preset ID	0xAF	XOR
Call Preset	0xA0	Address	0x00	0x07	0x00	Preset ID	0xAF	XOR
Auto Focus	0xA0	Address	0x00	0x2B	0x00	0x01	0xAF	XOR
Manual Focus	0xA0	Address	0x00	0x2B	0x00	0x02	0xAF	XOR
Query Pan Position	0xA0	Address	0x00	0x51	0x00	0x00	0xAF	XOR
Query Pan Position Response	0xA0	Address	0x00	0x59	Value High Byte	Value Low Byte	0xAF	XOR
Query Tilt Position	0xA0	Address	0x00	0x53	0x00	0x00	0xAF	XOR
Query Tilt Position Response	0xA0	Address	0x00	0x5B	Value High Byte	Value Low Byte	0xAF	XOR
Query Zoom Position	0xA0	Address	0x00	0x55	0x00	0x00	0xAF	XOR
Query Zoom Position Response	0xA0	Address	0x00	0x5D	Value High Byte	Value Low Byte	0xAF	XOR

Menu Settings

1. MENU

Press the [MENU] button to display the main menu on the screen. Use the arrow button to move the cursor to the item to be set. Press the [HOME] button to enter the corresponding sub-menu.

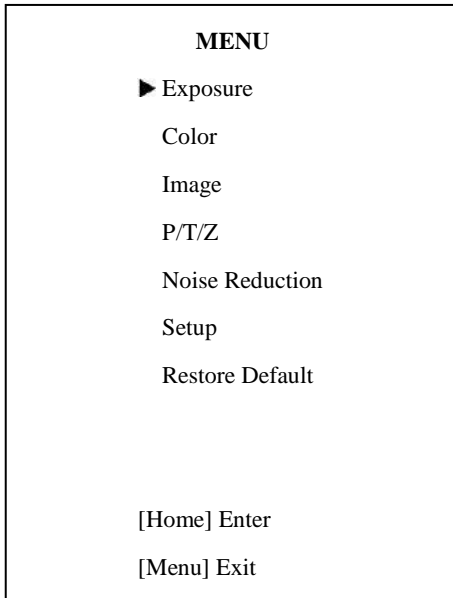

2. EXPOSURE

Move the cursor to the Exposure item in the main menu and press [HOME] button. The EXPOSURE menu appears, as shown in the following figure.

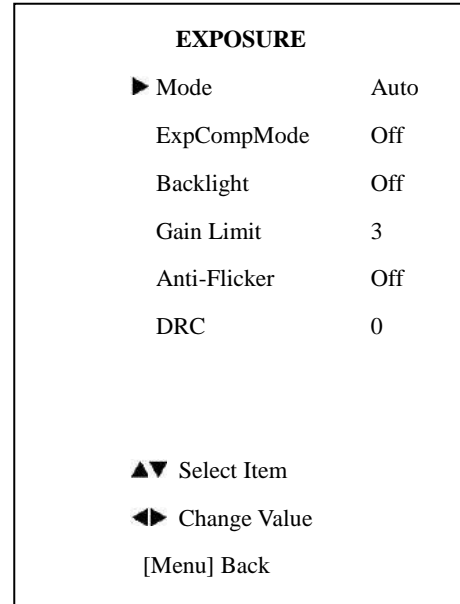

Mode: Exposure mode. Optional items: Auto, Manual, SAE, AAE, Bright

ExpCompMode: Exposure compensation mode, Optional items: On, Off (Effective only in Auto mode). ExpComp: Exposure compensation value, Optional items: -7 ~ 7 (Effective only when ExpCompMode is On)

Backlight: Set the backlight compensation, Optional items: On, Off (Effective only in Auto mode)

Gain Limit: Maximum gain limit. Optional items: 0 ~ 15 (Effective only in Auto, AAE, Bright modes)

Anti-Flicker: Anti-flicker. Optional items: On, Off, 50Hz, 60Hz (Effective only in Auto, Bright mode)

DRC: Dynamic Range Control Strength, Optional items: 0 ~ 8.

Bright: Intensity control, Optional items: 00~17.
(Effective only in Bright mode)

Iris: Aperture value. Optional items: F1.8, F2.0,F2.4,F2.8,F3.4,F4.0,F4.8,F5.6,F6.8,F8.0,F9.6,F11.0, Close (Effective only in Manual, AAE mode)

Shutter: Shutter value. Optional items: 1/30,1/60, 1/90,1/100,1/125,1/180,1/250,1/350,1/500,1/725,1/1000,1/1500,1/2000,1/3000,1/4000,1/6000,1/10000 (Effective only in Manual, SAE mode)

3. COLOR

Move the cursor to the Color item in the main menu and press [HOME] button, COLOR menu appears, as shown in the following figure.

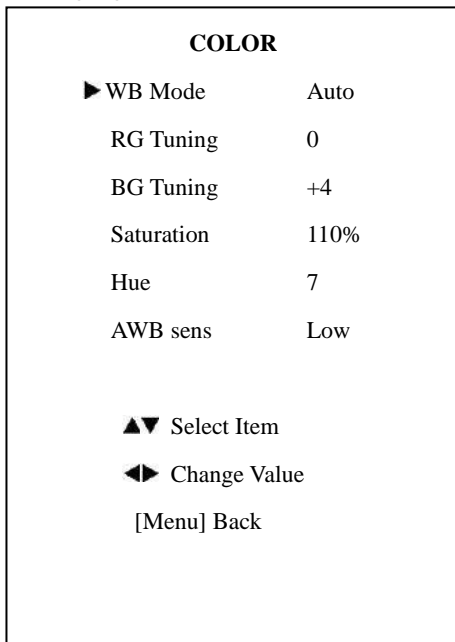

WB-Mode: White balance mode. Optional items: Auto, 3000K/Indoor, 4000K, 5000K/Outdoor, 6500K-1, 6500K-2, 6500K-3, One Push (ok), Manual

RG: Red gain. Optional items: 0~255 (Effective only in Manual mode)

BG: Blue gain. Optional items: 0~255
(Effective only in Manual mode)

RG Tuning: Red gain fine-tuning, Optional items: -10 ~ +10 (Effective only in Auto, Indoor, Outdoor mode)

BG Tuning: Blue gain fine-tuning, Optional items: -10 ~ +10 (Effective only in Auto, Indoor, Outdoor mode)

Saturation: Color Saturation. Optional items: 60% ~ 200%.

Hue: Chroma adjustment, Optional items: 0 ~ 14

AWB sens: The white balance sensitivity, Optional items: Low, Middle, High.

4. IMAGE

Move the cursor to the Image item in the main menu and press [HOME] button, IMAGE menu appears, as shown in the following figure.

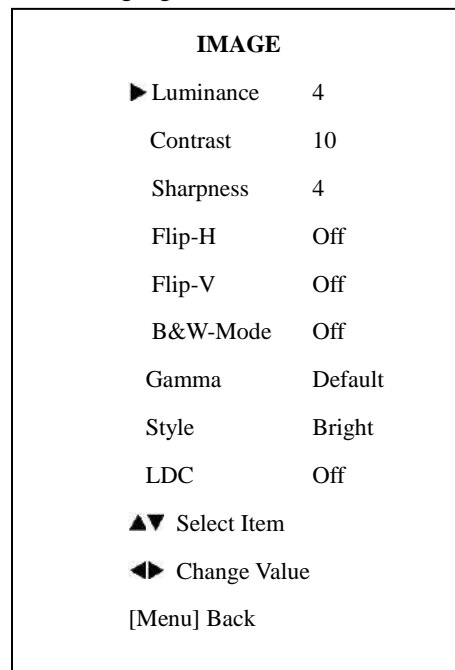

Luminance: Brightness adjustment. Optional items:

0 ~ 14

Contrast: Contrast adjustment. Optional items: 0 ~ 14

Sharpness: Sharpness adjustment. Optional items: Auto,

0 ~ 15

Flip-H: Image flipped horizontally. Optional items: On,

Off

Flip-V: Image Flip Vertical. Optional items: On, Off

B&W-Mode: Image color. Optional items: On,

Off

Gamma: Optional items: Default, 0.45, 0.5, 0.56,

0.63

Style: Image presets. Optional items: Soft, Norm, Clarity,

Bright

LDC: Lens Distortion Compensation Optional items: Off,

On

5. P/T/Z

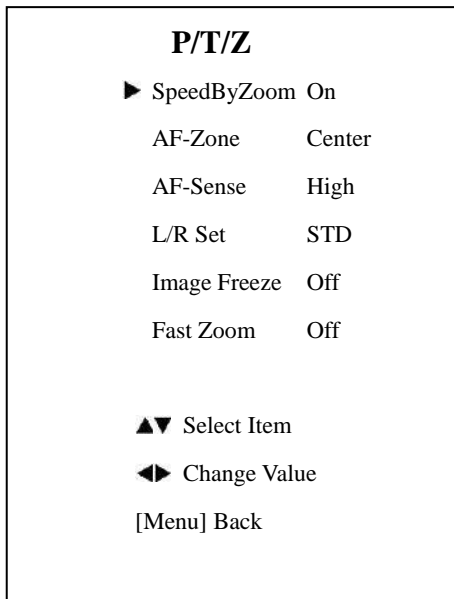

SpeedByZoom: The depth of field scale switch, Optional items: On, Off

AF-Zone: Auto focusing area, Optional items: Top,

Center, Bottom

AF-Sense: Automatic focusing sensitivity options,

Optional items: Low, Normal, High

L/R Set: Reverse pan controls, Optional items: STD,

REV

Image Freeze: Enables image freeze, Optional items: Off,

On

Fast Zoom: Enables fast zoom, Optional items: Off, On

6. NOISE REDUCTION

Move the cursor to the Noise Reduction item in the main

menu and press [HOME] button, NOISE REDUCTION

menu appears, as shown in the following figure.

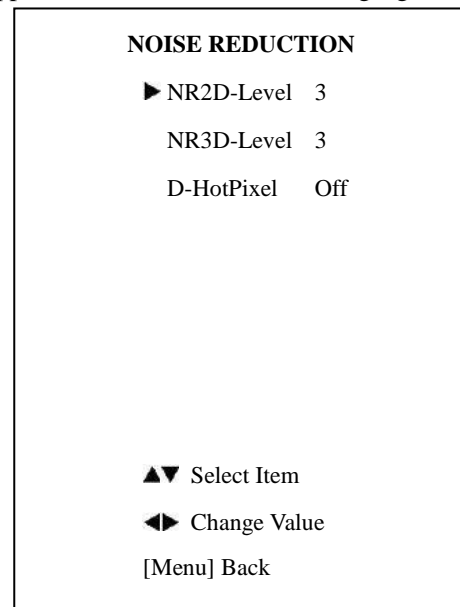

NR2D-Level: 2D noise reduction. Optional items: Off,

Auto, 1 ~ 5

NR3D-Level: 3D noise reduction. Optional items: Off,

1 ~ 8

D-HotPixel: Dynamic bad points, Optional items: Off,

1 ~ 5

7. SETUP

Move the cursor to the Setup item in the main menu and press [HOME] button, SETUP menu appears, as shown in the following figure.

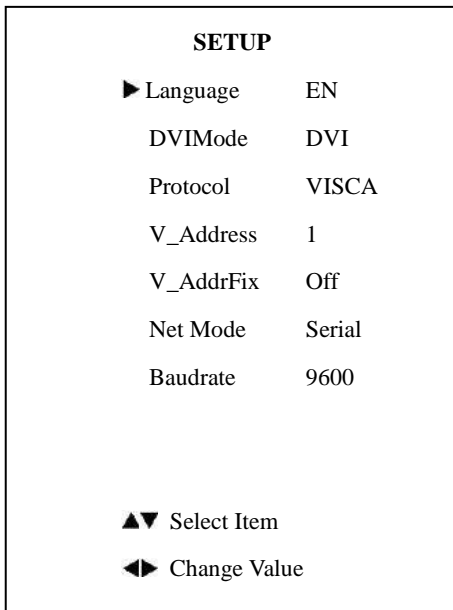

Language: Menu language, Optional items: EN, Chinese, Russian

DVIMode: Digital signal type for HDMI port, Optional items: DVI, HDMI

Protocol: Control protocol type. Optional items: AUTO, VISCA, PELCO-D, PELCO-P

V_Address: VISCA address, Decided according to the argument of Protocol; Optional items: VISCA (1~7), PELCO-D (0~254), PELCO-P (0~31)

P_D_Address: PELCO-D address; Optional items: 0 ~ 254

P_P_Address: PELCO-P address; Optional items: 0 ~ 31

V_AddrFix: Lock IR Address from changing via serial control, Optional items: On, Off (When set to On, 88 30 01 FF Command will not function)

Net Mode: Set the serial port control networking,

Optional items: Serial, Paral (parallel)

Baudrate: Serial port baud rate. Optional items: 2400, 4800, 9600

8. RESTORE DEFAULT

Move the cursor to the Restore Default item in the main menu and press [HOME] button, RESTORE DEFAULT menu appears, as shown in the following figure.

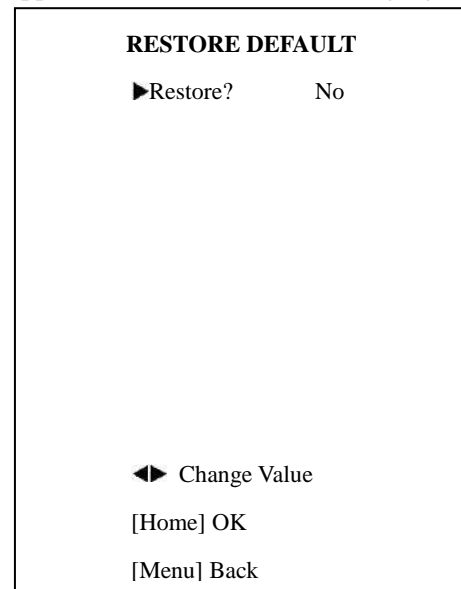

Restore: Reset all settings to factory default settings.

Optional items: Yes, No

Note: Press [HOME] button to confirm, All parameters are then restored to default values, including IR Remote address, VISCA Address and Pelco addresses.

9. Saving

Save: Save setting changes. Optional items: Yes, No

Network Connection

1. Operating Environment

Operating System: Windows 2000/2003/XP/Vista/7/8.1/10

Network Protocol: TCP/IP

Client PC: P4/128M RAM/40G HD/ support for scaled graphics card, support for DirectX 8.0 or more advanced version.

2. Equipment Installation

- 1) Connect camera to your network via a CAT5 or CAT6 patch cable or directly to your PC via a CAT5 or CAT6 crossover cable.
- 2) Turn on camera power.
- 3) If successful, the orange network light will illuminate and the green light will start flashing. If unsuccessful, the patch cable is bad, you are using the wrong cable (patch *aka* “*straight-thru*” cable for connection through a LAN; crossover for a direct PC connection) or you have connected to an inactive network jack.

3. Network Connection

Connection method between network camera and computer, as in pictures 1.1 and 1.2, below:

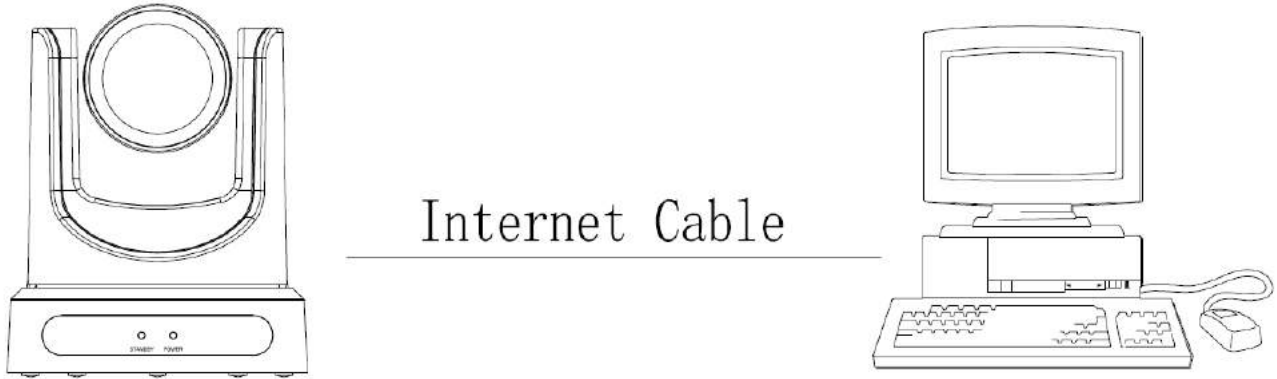

Picture 1.1 Direct connections via “cross-over” network cable

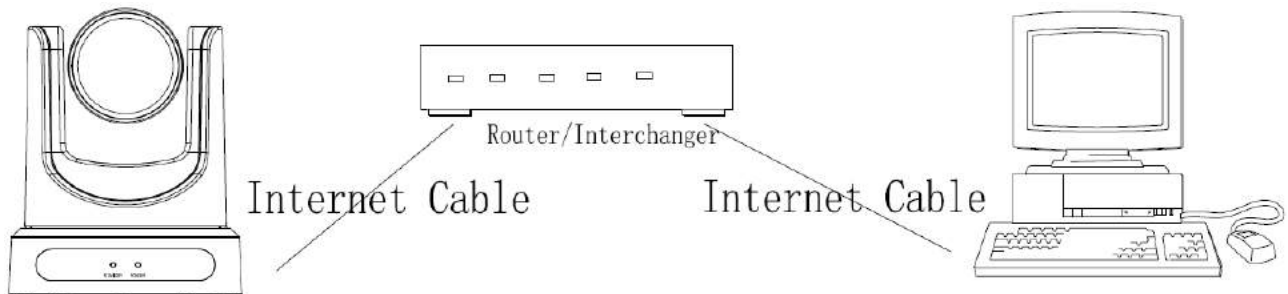

Picture 1.2 Connections to LAN via patch cable to LAN wall jack or LAN switch

Setting up a Network Video Stream with the PTZOptics camera

(Also see information on camera web information in the following section)

1. The first thing you are going to want to do to get your camera up and streaming on your network is to connect your camera to power, to an active network port on your network and finally to power the camera on.
2. Next, go online and download the IP address setting tool, for Windows Operating Systems, from the [PTZOptics Download Page](#). Once you complete the installation and launch the tool “UPGRADE v2.6” you should be able to click the “Search” button to locate all of the available PTZOptics cameras on your network.

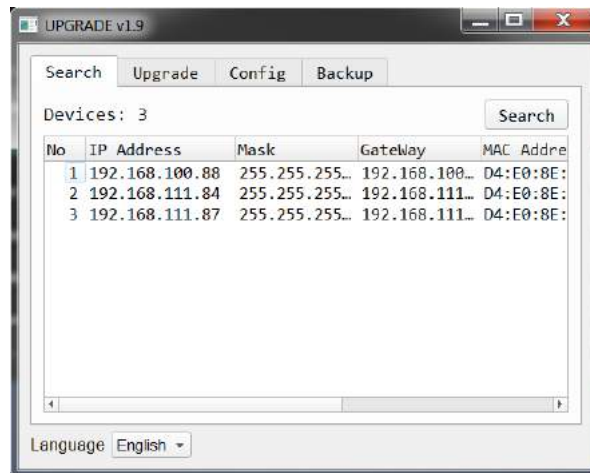

3. The next thing you would want to do is change your cameras IP address to be in the same range as your network. The camera comes with a default static IP address of 192.168.100.88. You will need to update that to be in the same range as your network. If you look at my example above, you can see, from other cameras on my network, that my network is set up to be in the range of 192.168.111.XXX. *Please see the “Extras” section at the end of this document for further information on finding your network IP scheme*
4. Once you know your IP range you can right click on the camera you wish to change the IP address for and click “config”. *NOTE: if you need to find the IP range of your network, you can do so by following the guide in the extras section at the end of this document.*

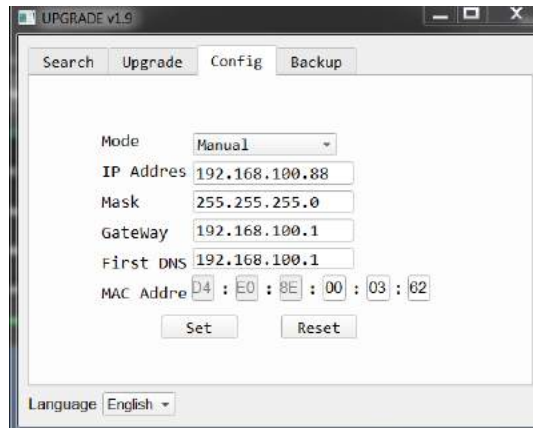

You should now be able to set your cameras IP address to one in the range of your network. You should be able to leave the subnet mask alone, unless you are configuring the camera for use across (example: 192.168.111.1)
(Note that in more complex network environments you may have to request a “STATIC IP” from the IT department to prevent any possible complications on your network in addition to the appropriate Network Mask, Default Gateway and First DNS for that Static IP)

5. Now that you have set the Static IP address of your PTZOptics camera, you should be able to pull up the video feed in a web browser. *We recommend using Mozilla Firefox ESR. You can view our [knowledge base article](#) for setup.*
6. If you go into the browsers mentioned above and type in the Static IP address you assigned to your camera, in step 4, you will be prompted for a Username and Password, both are “admin” by default.
7. You may be prompted to download the VLC Player Plugin; be sure to allow for both the Mozilla plugin and the ActiveX plugin if on a PC. If you are on a MAC, you need to move the VLC plugin, once downloaded, into the internet plugins folder. See the images below for further clarification.

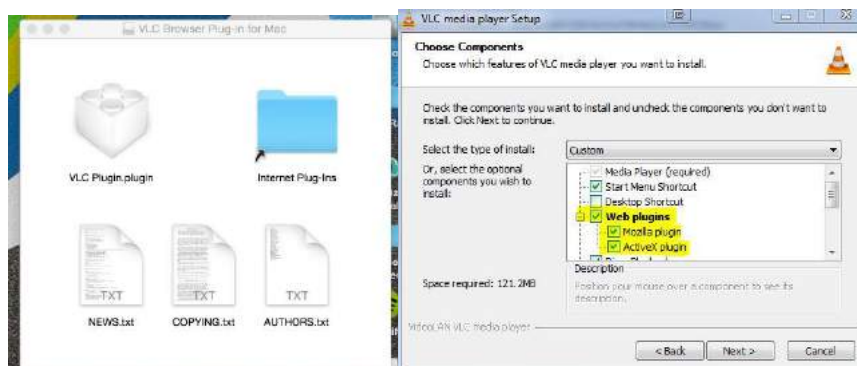

8. You should now be able to see the IP interface in the recommended browser with your live camera feed. You should have full PTZ control over your camera using the PTZ controls on the left side. You can adjust many of your cameras settings via the IP interface.

The main thing to note about the IP interface is that all adjustments will occur on the IP stream only. It will not affect the HDMI, SDI or USB connections of the camera. In addition, presets set in the IP interface will not be the same as the IR remote presets and vice-versa.

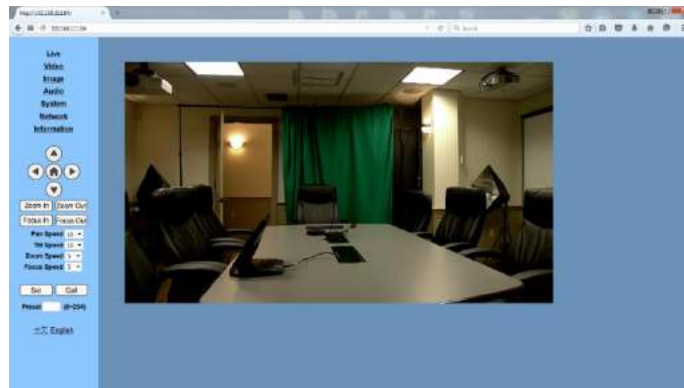

9. You should now be able to receive an RTSP stream from your camera. The following video, <https://www.youtube.com/watch?v=hmql0hjTOUI&feature=youtu.be>, shows how to setup an RTSP stream in Wirecast. You'll see how to use ONVIF to easily set up 2 PTZOptics cameras with Wirecast, the ONVIF feature must be enabled in the "Network" settings for ONVIF discovery, in addition to setting up a standard RTSP stream.
10. You can test the RTSP stream in VLC media player. Once you install VLC and launch the program you should be able to go to the "Media" drop down menu and then select "Open Network Stream". In the network URL, you should enter "rtsp://<ip-address>:554/1". In the example below, for a PTZOptics camera with the static IP address of 192.168.111.84, the RTSP stream would be accessed by entering rtsp://192.168.111.84:554/1. The "554" part is the port number used by the cameras, and the "1" is the stream number. (There are two RTSP network streams available; one for HD content "1" and one for SD content "2")

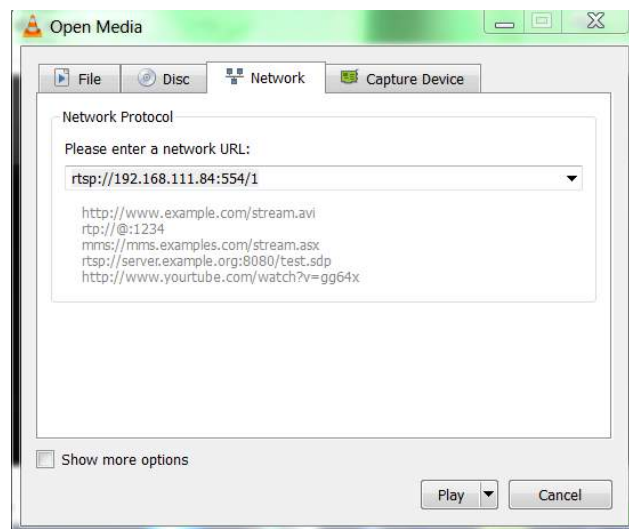

EXTRAS

1. **Discovering your Network IP range.** *NOTE: Changing your IP address without talking to your network admin could lead to conflicts with your network. If you change your address to one that is already in use it will cause communication problems.*

If you need to discover the IP address range of your network you can do so by using command prompt for Windows or Terminal for Macs.

To do this on a PC, you would type “CMD” into your search bar in the Windows menu. You should see a black box pop up with the ability to type in the box.

If you type “ipconfig” and hit “Enter” on your keyboard you will see a bunch of information pop up in your command prompt.

When you see “IPV4 Address” that is your computers IP address on your current network. So you would use the first 3 sets of numbers from this as your IP range.

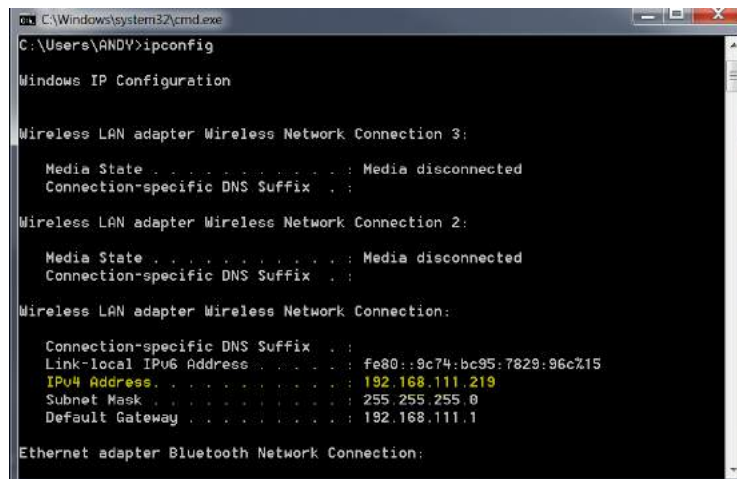

If you need to find the IP range of your MAC computer, you would first open a new finder window and then go to Applications, and then Utilities. You should see the program “Terminal” in that menu, select that program.

Now, you would type in “IP config getifaddr en0” Once you type this string and click “Enter” on your keyboard you will receive back an IP address.

So the IP range of my network, according to my MAC is 192.168.111.xxx, you can use this to figure out the IP range in which your camera needs to be set.

```
Blackmagic stephaniepeters ~ -bash — 80x24 EPSON WF-7520 S
Last login: Tue Oct 27 08:24:05 on console
Stephanies-MacBook-Pro:~ stephaniepeters$ ipconfig
usage: ipconfig <command> <args>
where <command> is one of waitall, getifaddr, ifcount, getoption, getpacket, get
v6packet, set, setverbose
Stephanies-MacBook-Pro:~ stephaniepeters$ ipconfig getifaddr en0
192.168.111.112
Stephanies-MacBook-Pro:~ stephaniepeters$
```

Camera Web Interface

1 Homepage introduction

1.1 Home Page

All pages include 2 areas:

On the left is the menu and camera control

On the right is real time monitoring - displaying video image and the Parameter settings

1.2 Video viewing window

Click “**Live**” in the menu area. The video viewing window will be resized based upon video resolution, the higher the resolution is, the bigger the playing area is. Double click the viewing window and it will show in full-screen. Double click again and it will return to the initial size.

The Status bar in the viewing window is as shown below:

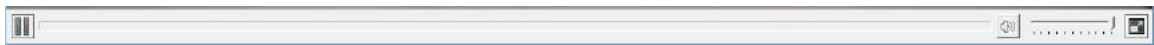

- 1) Video playback/pause button: controls real-time video. Pause to freeze the image, play to return to live video.
- 2) Audio control buttons: Mute and Volume controls for audio input on camera, if being used.
- 3) Full screen button will switch between Full Screen and Windowed view.

1.3 PTZ Control

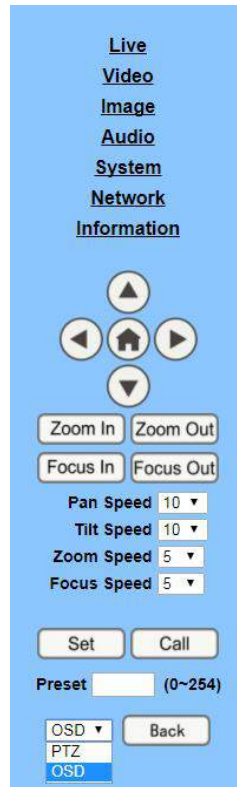

- 1) Pan and Tilt control: Up, Down, Left and Right arrows and the home button allow you to manual drive the camera to the desired position.
- 2) Zoom: Zoom in and Zoom out buttons allow for wide or narrow (tele) views of the space.
- 3) Focus: Focus In and Focus Out buttons allow for fine manual focus adjustment if the camera has any problems autofocusing on a difficult object.
- 4) PTZ Speeds: Pan speed can be set at any rate between 1 - 24, Tilt speed can be set at any rate between 1 - 20. Zoom and Focus speeds can be set at any rate between 0 – 7.
- 5) PTZ Presets: After manually setting up a shot that you would like to return to later, you can save presets for quick recall of these positions. Type a number between 0 and 254 into the Preset box. Click the "Set" button to save the current location with that preset number. Click the "Call" button to cause the camera to return to that position. This enables smooth, quick and convenient control without the need to manually drive the camera.
- 6) PTZ/OSD dropdown: From the dropdown menu, clicking the OSD option will open the on screen display menu of the camera giving you control from within the IP interface

1.4 Language selection

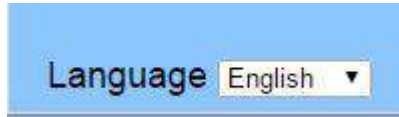

Click either “Russian”, “Chinese” or “English” to change the language of the menu.

1 Media

1.1 Video Setup

Click "Video". The streaming parameters may now be set in the right side area. The camera can send 2 simultaneous streams. For example, you can send one stream in HD and one in SD so that both PCs and phones may have their own stream resolution.

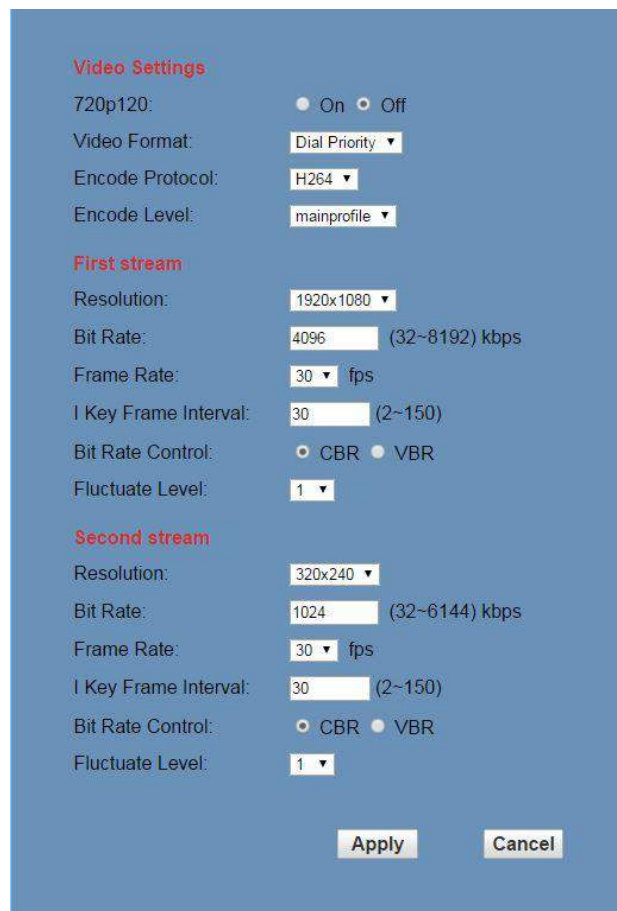

1) Video Settings

720p120

Allows camera to output 720p at 120fps via the IP Streaming output only. Set to ‘On’ or ‘Off’. (Note: Setting

to 'On' will override and lockout other video settings).

Video format

Supports 50HZ(PAL) and 60HZ(NTSC) and Dial Priority (see rotary dial on camera) formats.
60Hz is used for North America.

Video Coding

You must select both Encode Protocol and Encode Level for H.264. Camera streaming supports either H.264 - with choice of "baseline", "mainprofile" and "highprofile" formats or H.265 video encoding (Note H.265 will override and lockout some other video settings).

2) First Stream

Resolution

Set the desired video stream resolution. The first stream allows 1920x1080 (1080p), 1280x720 (720p) or 1024x576. The second stream allows 720x576 or 320x240. Higher resolutions will consume more bandwidth.

Bit Rate

Users can assign the bit rate of the stream (from 32 – 8192 kbps for 1st stream and 32-6144 kbps for 2nd stream). Higher bit rates will provide for a higher quality image, if your network bandwidth is sufficient to support the rate.

Maximum frame rate:

Users can specify the maximum frame rate (fps or frames per second). Higher frame rates provide smoother video but require higher bit rate settings.

I key frame interval:

Affects the quality of the video compression. This setting defines how many predicted frames will be used for each actual frame (from 2-150). Shorter intervals increase video quality at the cost of requiring higher bit rates in order to look good.

Bit Rate Control method:

Constant bit rate: video encoder will encode at a constant rate as set in bitrate setting

Variable bit rate: video encoder will encode at a variable rate with maximum as set in bit rate setting, allowing for low motion scenes to use less bandwidth.

Fluctuate level

This setting affects how aggressive variable bit rate adjustments will be (1-6). Spikes that are too large may affect video quality. Low levels will not save on as much bandwidth.

3) Second Stream (See parameters above for first stream).

1.2 Image Setup

Click “Image”. The image parameters may now be set in the right side area.

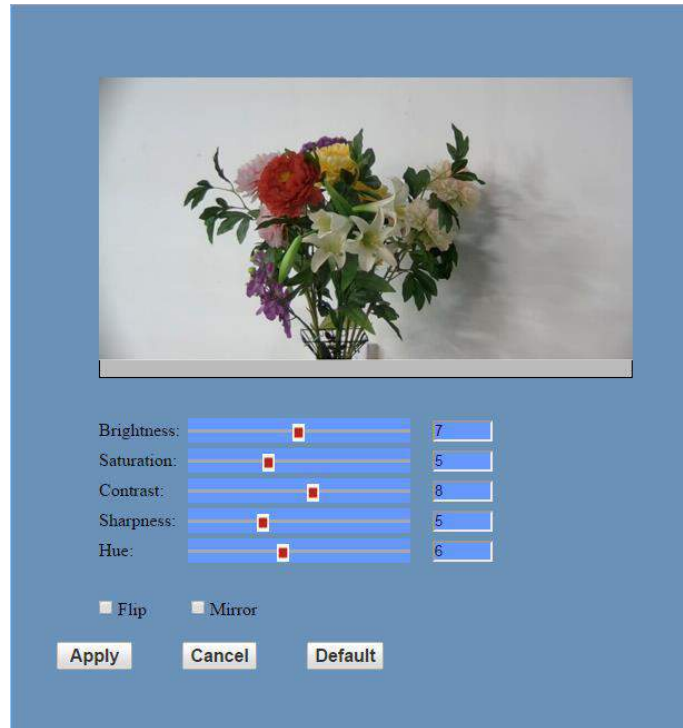

Brightness

Image brightness 0-14. Use the slider control. The box on the right shows the corresponding numerical value. The Default setting is 7.

Saturation

Color Saturation 0-14. Use the slider control. The box on the right shows the corresponding numerical value. The Default setting is 5.

Contrast

Contrast 0-14. Use the slider control. The box on the right shows the corresponding numerical value. The Default setting is 8.

Sharpness

Sharpness 0-15. Use the slider control. The box on the right shows the corresponding numerical value. The Default setting is 5.

Hue

Hue 0-14. Use the slider control. The box on the right shows the corresponding numerical value. The Default setting is 6.

Flip & Mirror

Check the “Flip” box to invert the image vertically for a ceiling mount. Check the “Mirror” box to invert the image horizontally. The default setting is unchecked.

Apply, Cancel and Default Buttons

After adjusting the parameters, press the "Apply" button to save settings. Press the "Cancel" button to cancel the adjustment of the parameters. Press the "Default" button to return to the default value.

1.3 Audio Setup

Click “Audio”. The audio parameters may now be set in the right side area.

Audio Settings

Audio Type: AAC ▾

Sample Rate: 48K ▾

Bit Rate: 96K ▾

Input Type: Line in ▾

Input Vol L : 8 (-97~30) db

Input Vol R : 8 (-97~30) db

ADTS Options: Off ▾

Apply Cancel

Audio Type: AAC is the only audio format currently supported.

Sample rate: Selectable as either 44.1 K and 48 K.

Bit rate: Selectable among 96k, 128k or 256k

Input Type: Currently Line in only

Input VolL: Sets the volume of the left audio channel (from -97 to +30dB)

Input VolR: Sets the volume of the right audio channel (from -97 to +30dB)

ADTS: Audio Data Transport Stream: Set to ‘On’ or ‘Off’ (use for MPEG 2 only – may not be applicable on all models)

Apply and Cancel Buttons

After modifying the parameters, press the "Apply" button to save. Press the "Cancel" button to leave settings unchanged.

1.4 System Settings

Click “System”. The system parameters may now be set in the right side area.

The screenshot shows a web interface for PTZ Optics. On the left, a blue sidebar contains a list of menu items: Live, Video, Image, Audio, **System**, Network, and Information. The 'System' item is highlighted. The main content area has a dark blue background and is titled 'Initialize' in red. It contains the following elements:

- Work Mode:** A dropdown menu with 'RTSP' selected.
- Reboot:** A button labeled 'Reboot'.
- User:** A section containing:
 - UserName:** A text input field with 'admin' entered.
 - Passwd:** A password input field with seven black dots.
- Buttons:** 'Apply' and 'Cancel' buttons at the bottom right.

1) Initialize

Work Mode: RTSP (Real Time Streaming Protocol) is the only streaming protocol currently supported.

Reboot: Click the "Reboot" button to initiate a system restart. This is required after changing some settings.

2) User

User and Password: The user can modify the password (letters and Numbers only).

The default settings are UserName: **admin** and Password: **admin**

Apply and Cancel Buttons

After modifying the parameters, press the "Apply" button to save. Press the "Cancel" button to leave settings unchanged.

1.5 Network Settings

Click “Network”. The network parameters may now be set in the right side area.

Lan Settings

IP Configuration Type: Fixed IP Address

IP Address: 192.168.100.88

Subnet Mask: 255.255.255.0

Gateway: 192.168.100.1

DNS Address: 192.168.100.1

MAC Address: D4 : E0 : 8E : C9 : 5C : 30

Port Settings

HTTP Port number: 80 (80)

RTSP Port: 554 (554)

PTZ Port: 5678 (5678)

Control Protocol Settings

Visca Address: 1 (1~7)

Pelco-D Address: 0 (0~255)

Pelco-P Address: 0 (0~31)

RTMP Settings

First stream: On Off Video Audio

MRL: rtmp://192.168.100.138/live/stream0

Second stream: On Off Video Audio

MRL: rtmp://192.168.100.138/live/stream1

RTSP Settings

RTSP Auth: On Off

ONVIF Setting

ONVIF: On Off

ONVIF Auth: On Off

Multicast Settings

Multicast: On Off

Address: 224.1.2.3

Port: 6688

Apply Cancel

1) LAN Settings

IP settings for the device can be set here using either static (fixed) or DHCP (dynamic) addressing as selected from the drop down list. The Default the IP address of the camera is 192.168.100.88. The MAC address can be modified but should be left as set by the factory. Please note that after changing the IP settings for the camera, you may not be able to reconnect until your PC is set for and connected to the same subnet or visible via proper network routing.

2) Port Settings

While the IP address identifies the device, the camera uses multiple ports.

HTTP Port: This is the port for the web application (the default http port: 80)

RTSP Port: The camera supports the RTSP streaming protocol. The default port: 554.

PTZ Port: Supports camera control via the TCP protocol. The default port: 5678.

3) Control Protocol Settings

Control addresses for VISCA (1-7), Pelco-D (0-254) and Pelco-P (0-31) may be set here.

4) RTMP settings

RTMP streaming may be enabled for 2 separate streams to a streaming server (or servers). Note: A separate streaming server is required for use of RTMP streaming. Set 1st and 2nd stream to 'On' or 'Off', check to include video and/or audio and type in the address and port or domain of the streaming server (MRL - Media Resource Locator).

5) RTSP Authorization

Turn authorization 'On' or 'Off' for RTSP streaming.

6) ONVIF Setting

Turn ONVIF compatibility 'On' or 'Off' (for ONVIF compatible streaming and control).

Turn ONVIF authorization 'On' or 'Off' (for ONVIF compatible streaming and control).

7) Multicast Setting

Turn Multicast streaming 'On' or 'Off' (Note: Do not attempt to use Multicast streaming unless your network has been setup and tested to support multicast, e.g. IGMPv3. Significant network performance issues may result otherwise. Also note: The public internet does not support multicast streaming).

Address and Port Settings: enter the multicast address and port to be used.

8) Apply and Cancel Buttons

After modifying the parameters, press the "Apply" button to save. Press the "Cancel" button to leave settings unchanged.

1.6 Device Information

Click “Information”

Shows the current device information, as shown below. You may change the device ID as required for your application.

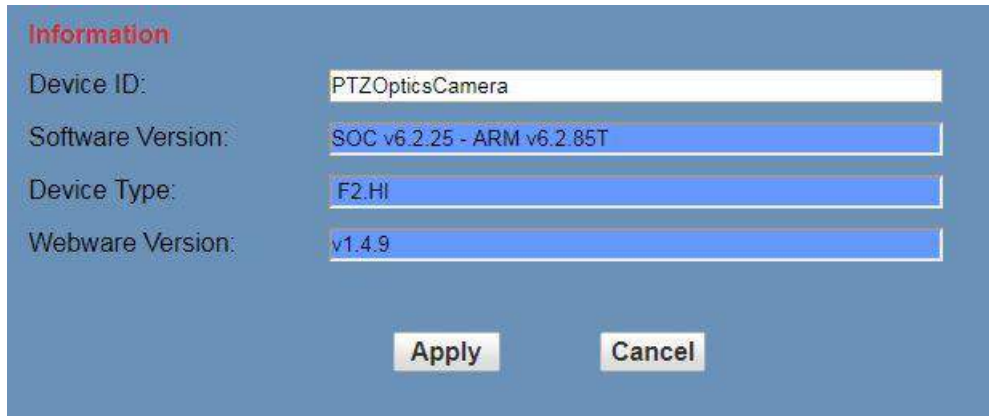

The screenshot shows a blue dialog box titled "Information" in red text. It contains four input fields with labels on the left and values in the input boxes:

- Device ID: PTZOpticsCamera
- Software Version: SOC v6.2.25 - ARM v6.2.85T
- Device Type: F2.HI
- Webware Version: v1.4.9

At the bottom of the dialog box, there are two buttons: "Apply" and "Cancel".

Network Camera Control Protocol

1. Setup camera for IP (first see “Setting up the Camera’s IP” section above)

Control Notes:

PTZ over TCP/UDP:

The camera currently supports various PTZ control methods, including RS232, RS485, IR remote control, web interface, HTTP-CGI and TCP /UDP protocol.

The camera includes an internal TCP server. The default port number is 5678. When client and server set up a TCP connection, the client sends PTZ command to the internal server and the server will then parse and execute the PTZ commands.

The camera includes an internal UDP server. The default port number is 1259. When client and server set up a UDP connection, the client sends PTZ command to the internal server and the server will then parse and execute the PTZ commands

The PTZ command format is based on the VISCA protocol as shown below:

The command presentation format used below is:

Control Command Group

Command Function Command Packet Note

HTTP CGI Method: The camera’s integrated web server supports HTTP CGI for PTZ control.

Pan and Tilt control URL format as below:

`http://[Camera IP]/cgi-bin/ptzctrl.cgi?ptzcmd&[action]&[pan speed]&[tilt speed]`

Parameter Descriptions:

[Camera IP]: camera IP address;

[action] including: up, down, left, right, ptzstop;

[pan speed] : 1(low speed) – 24(high speed);

[tilt speed]: 1(low speed) – 20(high speed).

Zoom control URLformat as below:

`http://[Camera IP]/cgi-bin/ptzctrl.cgi?ptzcmd&[action]&[zoom speed]`

[action] including: zoomin, zoomout, zoomstop;

[zoom speed]: 0(low speed) – 7(high speed)。

Focus control URLformat as below:

`http://[Camera IP]/cgi-bin/ptzctrl.cgi?ptzcmd&[action]&[focus speed]`

[action] including: focusin, focusout, focusstop;

[focus speed]: 0(low speed) – 7(high speed)

Preset Position control URL format as below:

`http://[Camera IP]/cgi-bin/ptzctrl.cgi?ptzcmd&[action]&[position number]`

[action] including: posset, poscall;

[position number]: 0-89, 100-254PTZ ON IP NETWORK

TCP Protocol Method: The camera's integrated web server supports TCP for PTZ control.

The camera has an internal TCP server. There is a port configured for receiving the connection from a TCP client.

The default TCP port number is 5678. When client and server initiate a TCP connection, the client sends PTZ command to the internal server and the server will then parse and execute the PTZ commands.

PTZ command format is based on VISCA Protocol to define, details as below:

Pan and Tilt

Control URL format as below:

http://[Camera IP]/cgi-bin/ptzctrl.cgi?ptzcmd&[action]&[pan speed]&[tilt speed]

[Camera IP]: This camera's IP address;

[action] including: up, down, left, right, ptzstop;

[pan speed] : 1(low speed) – 24(high speed);

[tilt speed]: 1(low speed) – 20(high speed).

Zoom

Control URLformat as below:

http://[Camera IP]/cgi-bin/ptzctrl.cgi?ptzcmd&[action]&[zoom speed]

[Camera IP]: This camera's IP address;

[action] including: zoomin, zoomout, zoomstop;

[zoom speed]: 0(low speed) – 7(high speed).

Focus

Control URLformat as below:

http://[Camera IP]/cgi-bin/ptzctrl.cgi?ptzcmd&[action]&[focus speed]

[Camera IP]: This camera's IP address;

[action] including: focusin, focusout, focusstop;

[focus speed]: 0(low speed) – 7(high speed)

Preset Position

Control URL format as below:

http://[Camera IP]/cgi-bin/ptzctrl.cgi?ptzcmd&[action]&[position number]

[Camera IP]: This camera's IP address;

[action] including: posset, poscall;

[position number]: 0-89,100-254.

Maintenance and Troubleshooting

Camera Maintenance

- If the camera will not be used for a long time, please turn off the power switch.
- Use a soft cloth or lotion-free tissue to clean the camera body.
- Use a soft dry lint-free cloth to clean the lens. If the camera is very dirty, clean it with a diluted neutral detergent. Do not use any type of solvent or harsh detergent, which may damage the surface.

Unqualified Applications

- Do not shoot extremely bright objects for a long period of time, such as sunlight, ultra-bright light sources, etc...
- Do not operate in unstable lighting conditions, otherwise the image may flicker.
- Do not operate close to powerful electromagnetic radiation, such as TV or radio transmitters, etc...

Troubleshooting

- No image
 1. Check whether the power cord is connected, voltage is OK, POWER lamp is lit.
 2. Check whether the camera can “self-test” after startup (camera will do a brief pan-tilt tour and return to the home position, or if preset 0 is set, the camera will return to the preset 0 position).
 3. Check the BOTTOM dip switch and make sure the two dip switches are both set OFF. These switches are not used in operating mode.
 4. Check that the HDMI cable is connected correctly.
 1. If HDMI, make sure that the destination device is accessing the HDMI port that you plugged into.
 2. If SDI, make sure that the destination device is accessing the SDI port that you plugged into.
- Abnormal display of image
 1. Check setting of rotary dial on rear of camera. Be sure to use a resolution and refresh rate that is supported by your software.
- Image is shaky or vibrating.
 1. Check whether camera is mounted solidly or sitting on a steady horizontal and level surface.
 2. Check the building and any supporting furniture for vibration. Ceiling mounts are often affected by building vibration more than wall mounts.
 3. Any external vibration that is affecting the camera will be more apparent when in tele zoom (zoomed in) settings.

Control

- IR remote controller does not control the camera
 1. Does one of the 4 “Camera Select” buttons (top row of remote) light up when you press any button on the remote?
 1. If not, change the batteries in the remote.
 2. Are the camera and remote set to the same IR address? You can use press [*] + [#] + [1] (3 buttons in sequence) on the remote to set the camera to address 1. Press “Camera Select” 1 on the remote to control the camera.
 3. Try removing other sources of IR interference (e.g. sunlight, fluorescent lighting).
- Serial communication does not control the camera
 1. Make sure the camera is on and functioning with the IR remote control.
 2. Verify that the RS232 cable is connected correctly and using the proper pinout.
 3. Verify the communication settings of the control software or device (e.g. joystick).
 4. Verify that the communication port on the controlling device is activated (e.g. Com port on PC).
 5. Verify that all communication settings in the OSD Setup Menu correlate to the commands being used (e.g. VISCA address).

Copyright Notice

The entire contents of this manual, whose copyright belongs to PTZ Optics, may not be cloned, copied or translated in any way without the explicit permission of the company. Product specifications and information referred to in this document are for reference only and as such are subject to updating at any time without prior notice.