

# plura<sup>®</sup>

## Operating Instructions

PRM-3G Series Monitors



**PRM-3G Series**

**PRM-217-3G**

**PRM-224-3G**

**PRM-232-3G**

<b>PRECAUTION</b> -----	<b>6</b>
<b>1. OVERVIEW</b> -----	<b>9</b>
<b>2. GENERAL FEATURES</b> -----	<b>9</b>
<b>3. FUNCTIONAL EXPLANATION OF EACH PART</b> -----	<b>10</b>
1) FRONT PANEL -----	10
● <i>PRM-224-3G</i> -----	10
● <i>Front Keys Arrangements</i> -----	10
● <i>Front Keys Operations</i> -----	11
● <i>Front panel LED Operations</i> -----	11
● <i>Speaker Out</i> -----	12
2) REAR PANEL -----	12
● <i>Connection Details</i> -----	12
● <i>DC Battery IN</i> -----	13
● <i>RJ-45</i> -----	13
● <i>Interface description</i> -----	14
<b>4. MENU OVERVIEW</b> -----	<b>14</b>
1) TO SHOW AND REMOVE THE MENU -----	14
2) TO GO TO THE NEXT LEVEL -----	14
3) TO GO BACK TO THE PREVIOUS LEVEL -----	15
4) TYPICAL MENU OPERATION -----	15
<b>5. BASIC OPERATION</b> -----	<b>15</b>
1) TURNING ON THE MONITOR-----	15
2) VOLUME ADJUSTMENT -----	15
3) ON SCREEN MENUS LANGUAGE SELECTION-----	15
<b>6. ON SCREEN MENUS SELECTION AND ADJUSTMENT</b> -----	<b>16</b>
1) HOW TO ADJUST THE OSD SCREEN -----	16
<b>7. SELECT VIDEO INPUT</b> -----	<b>17</b>
1) HOW TO SELECT VIDEO SOURCE BY OSD-----	17
<b>8. PICTURE MENU OPTIONS</b> -----	<b>18</b>
1) VIDEO MENUS OF EACH INPUT MODES -----	18
2) ADJUST-----	18





3) COLOR TEMPERATURE CONTROL -----	18
4) SCAN -----	19
5) ASPECT RATIO -----	19
6) ZOOM-----	19
7) MONO/BLUE ONLY -----	20
8) PC MENU (PC MODE ONLY) -----	20
9) FLIP -----	21
10) NR (NOISE REDUCTION) -----	21
<b>9. AUDIO MENU OPTIONS -----</b>	<b>21</b>
1) MAIN / SUB AUDIO OUT -----	21
2) SDI 1/ SDI 2 AUDIO OUTPUT CHANNEL -----	21
3) SDI 1 ,/SDI 2 AUDIO GROUP -----	21
4) LEVEL METER -----	22
5) AUDIO LOUDNESS -----	23
6) VOLUME-----	23
<b>10. MARKER MENU OPTIONS-----</b>	<b>24</b>
1) MARKER & USER MARKER-----	24
2) SAFETY AREA -----	25
3) CENTER MAKER-----	25
4) MARKER WIDTH -----	25
5) MARKER COLOR -----	25
6) PRESET1 & PRESET2 -----	25
<b>11. GPI MENU OPTIONS-----</b>	<b>26</b>
1) GPI CONTROL & GPI# -----	26
<b>12. SETUP MENU OPTIONS -----</b>	<b>27</b>
1) SETUP LOAD & SETUP SAVE -----	27
2) FUNCTION 1 ~6 -----	27
3) ON SCREEN DISPLAY -----	28
● <i>OSD Option</i> -----	28
● <i>Time code</i> -----	28
● <i>Under Monitor Display (color: Tally R/G mode action )</i> -----	28
● <i>Input ID</i> -----	29
● <i>SDI Signal state</i> -----	29

4)	ADVANCED -----	29
●	<i>Information</i> -----	30
●	<i>Control</i> -----	30
●	<i>Screen Saver</i> -----	30
●	<i>Screen Control</i> -----	30
●	<i>Fan Control</i> -----	31
●	<i>X768 Mode</i> -----	31
5)	CAPTION -----	31
6)	WAVEFORM FORMAT (ONLY SDI MODEL) -----	32
●	<i>Y-Pb-Pr Waveform</i> -----	32
●	<i>Y-Waveform + Vector Scope</i> -----	32
●	<i>Double</i> -----	33
●	<i>Y-Waveform + Vector Scope Trans</i> -----	33
●	<i>Vector Color</i> -----	34
●	<i>Line Select</i> -----	34
●	<i>Line #</i> -----	34
●	<i>Line Display</i> -----	34
7)	DUAL LINK MODE(SDI ONLY) -----	34
8)	SET ID & ACTIVE SET ID -----	34
<b>13.</b>	<b>PIP (PICTURE IN PICTURE) -----</b>	<b>34</b>
1)	PIP ON/OFF -----	34
2)	INPUT SOURCE -----	34
3)	ASPECT RATIO -----	35
4)	POSITION -----	35
5)	PIP BLEND -----	36
6)	PIP SWAP -----	36
7)	SOUND SELECT -----	36
8)	SUB WINDOW FUNCTION -----	36
<b>14.</b>	<b>OSD TREE -----</b>	<b>37</b>
1)	Video -----	38
2)	Audio -----	39
3)	MARKER -----	40
4)	GPI -----	41
5)	SETUP -----	42



## Precaution

*Before operating the set, please read this manual carefully.*

  <b>WARNING</b> RISK OF ELECTRIC SHOCK DO NOT OPEN	 <p>The lightning flash with arrowhead symbol, within an equilateral triangle, is intended to alert the user to the presence of uninsulated "dangerous voltage" within the product's enclosure that may be of sufficient magnitude to constitute a risk of electric shock to persons.</p>
<b>WARNING :</b> The unit is operated at dangerous voltages. The unit may only be opened by an authorized specialist. All maintenance and servicing work must be carried out by an authorized company. Repairs that are carried out incorrectly could result in fatal injuries to the user.	 <p>The exclamation point within an equilateral triangle is intended to alert the user to the presence of important operating and maintenance (servicing) instructions in the literature accompanying the appliance.</p>

### **WARNING:**

To reduce the risks of electric shock don't remove back cover. No user serviceable parts inside. For service refer to qualified service personnel. To prevent fire or shock hazard, do not expose the rear of the set to water or moisture. Do not rub or strike the Active Matrix LCD with any harsh materials as this may scratch, mark, or damage the Active Matrix LCD permanently.

### **CAUTION:**

Unauthorized tampering with the inside of the monitor invalidates the warranty.

The manufacturer shall not warrant any damage caused by improper maintenance and/or repair executed by an authorized third party.

Important safeguards for you and your new product:

Your product has been manufactured and tested with your safety in mind. However, improper use can result in potential electrical shock or fire hazards. To avoid defeating the safeguards that have been built into your new product, please read and observe the following safety points when installing and using your new product and save them for future reference.

*1. Read Instructions*

*2. Follow Instructions*

*All operating and use instructions should be followed.*

*3. Retain Instructions*

*The safety and operating instructions should be retained for future reference.*

*4. Take note of Warnings*

*All warnings on the product and in the operating instructions should be adhered to.*

*5. Cleaning*

*Disconnect the unit from the electric supply before cleaning. Do not use abrasive cleaners. Use a damp cloth for cleaning.*

**6. Water and Moisture**

*Do not use this unit near water.*

**7. Transporting Product**

*A product and cart combination should be moved with care. Quick stops, excessive force and uneven surfaces may cause the product and cart combination to overturn.*

**8. Attachments**

*Do not use any third party attachments not recommended by **PLURA**, as this may cause hazards.*

**9. Ventilation**

*Do not block any of the ventilation openings.  
Install in accordance with the manufacturer's instructions.*

**10. Power Sources**

*This product should be operated only from the type of power source indicated on the marking label. If you are not sure of the type of power supply to your home, consult your dealer.*

**11. Power Lead Polarization**

*This product is equipped with a three-wire grounding-type cord. This is a safety feature. Do not neglect the safety purpose of the grounding-type cord.*

**12. Power Cord Protection**

*Power-supply cord should be routed so that they are not likely to be walked on or pinched by items placed upon or against them, paying particular attention to cords at plugs, convenience receptacles and the point where they exit from the product.*

**13. Outdoor Cable Grounding**

*If an outside antenna or cable system is connected to the product, be sure the antenna or cable system is grounded so as to provide some protection against voltage surges and built-up static charges. A "face plate" also needs to be installed with an isolating capacitor to prevent any damage from static.*

**14. Lightning**

*For added protection for this product during a lightning storm, or when it is left unattended and unused for long periods of time, unplug it from the wall outlet and disconnect the antenna or cable system. This will prevent possible damage to the product due to lightning and power-line surges.*

**15. Power Lines**

*An outside antenna system should not be located in the vicinity of overhead power lines or other electric light or power circuits, or where it can fall into such power lines or circuits. When installing an outside antenna system, extreme care should be taken to avoid contact with such power lines or circuits, as contact with them might be fatal.*

## 16. Earthing the product

*This product must be earthed properly to comply with the safety regulations in the country of use. If you are unsure of these regulations, please consult a qualified electrician.*

## 17. Servicing

*Do not attempt to service this product yourself as opening or removing covers may expose you to dangerous voltages or other hazards. Refer all servicing to qualified service personnel. If the Set does not operate properly, switch it off and call your dealer.*

## 18. Damage Requiring Service

*Isolate this product from the mains supply and refer servicing to qualified service personnel under the following conditions:*

- A. If the power-supply cord or plug is damaged.*
- B. If the glass front has been damaged.*
- C. If there is ingress of water between the glass and the LCD screen.*
- D. If the product does not operate normally by following the operating instructions. Adjust only those controls that are covered by the operating instructions as an improper adjustment of other controls may result in damage and will often require extensive work by a qualified technician to restore the product to its normal operation.*
- E. If the product has been dropped or the cabinet has been damaged.*
- F. If the product exhibits a distinct change in performance.*

## 19. Safety Check

*Upon completion of any service or repairs to this product, ask the service technician to perform safety checks to determine that the product is in proper operating condition and the front seal is intact.*

## 20. Mounting

*The product should be mounted on a wall only as recommended in the instructions.*

## 21. Power

*This set operates on an AC supply; the voltage is as indicated on the label on the Manual. This appliance must be earthed at all times through the chassis as well as through the power lead.*



Note

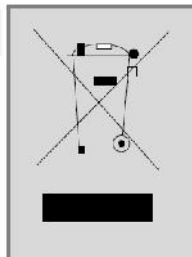

This product is designed and manufactured with high quality materials and components which can be recycled and reused. This symbol means that electrical and electronic equipment, at their end-of-life, should be disposed of separately from your household waste. Please, dispose of this equipment at your local community waste collection/recycling centre. In the European Union there are separate collection systems for used electrical and electronic product. Please, help us to conserve the environment we live in!



# ***1. OVERVIEW***

This product is the multi-format Digital LCD Panel to display various kinds of digital video input signal as HD/SD-SDI Digital and analog signal such as Composite/S-Video/RGB/PC-RGB/DVI/HDMI/Component.

This is also High Definition Broadcasting Monitor which can make it available to do output of stable video signal with the menu of considering convenient user interface and the easy control for brightness and color, and by EQ function of HD-SDI input part.

# ***2. GENERAL FEATURES***

- HD/SD SDI 2Input / 2Output.
- WAVEFORM / Vector Scope / Time code Display.
  - Dual waveform display available
- 16 ch Audio Level Meter Display. (SDI only)
- Analog & Digital Signal Audio Level Meter Display.
  - Level Meter Size display selectable (Small or Large)
- Dual Link MODE & 1080p 60 Compatible
- Closed Caption CEA 608, 708, Line 801 & OP-47
- H Flip, H/V Delay.
- Audio Disembedder & Internal Speaker & Headphone out & Monitor out
- Color Temperature – User, VAR, 11000K, 9300K, 6500K, 5400K, 3200K
- Over Scan/Zero Scan/Under Scan/Pixel to Pixel
- PIP (Picture In Picture)/PIP Blend
- Tally LED function (Green/Red/AMBER)
- Integrated DVI (HDCP) function.
- HDMI (HDCP) function.
- Supports VESA DDC2B and a subset of VESA standards.
- Single board is suitable for mounting behind an LCD panel.
- Support RS-232C.
- Support External GPI Control (RJ-45).
- OSD: Graphic based OSD, 7 Languages (UNICODE System).
- LCD Dimming Control
  - Manual Dimming Level Control.
- Rack Mount (OPTION)
- Battery Mount (OPTION)
- UMD
- Native Calibration: CA-310, CA-210 (Minolta), K-10 (Klein)
- 10bits 3D LUT Color Calibration (BT.709, SMPTE-C, EBU, NTSC, D-Cinema)
- Multi Control(RS-232C)
- Lan To Serial
- Audio Loudness(LKFS)

### 3. Functional explanation of each part

#### 1. Front Panel

- PRM-224-3G



#### • Front Keys Arrangements

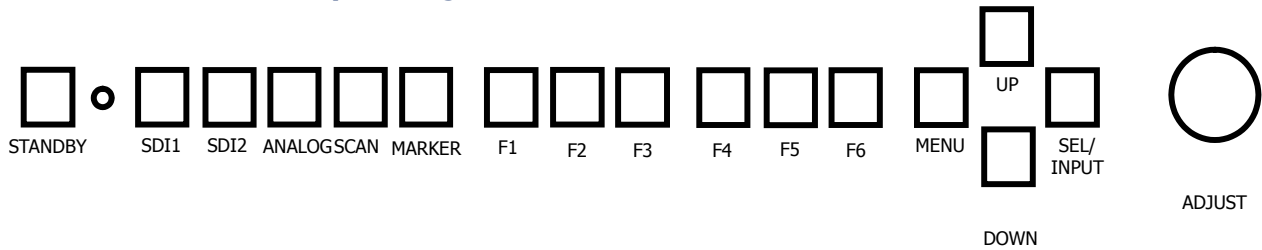

- **Front Keys Operations**

Key Name	Operation
STANDBY	▶ Power ON/OFF Button. This button is operated after being pressed about 3 seconds.
SEL/INPUT	▶ Activates OSD menu of input source selecting. ▶ Changes input source by selecting. ▶ Executes functions (by OSD help commands) in main OSD menu. ▶ Activates child menu.
DOWN	▶ Decreases sound volume of speaker. ▶ Decreases values of user menu in main OSD menu. ▶ Executes function (by OSD help commands) in main OSD menu.
UP	▶ Increases sound volume of speaker. ▶ Increases values of user menu in main OSD menu. ▶ Executes function (by OSD help commands) in main OSD menu.
MENU	▶ Activates main OSD menu. ▶ Navigates higher menu in main OSD menu. ▶ Exits OSD menu.
FUNCTION 1	▶ Executes functions of user selected UNDEF, Marker Size, Audio LV Meter, Wf/Vector, H/V delay. Aspect, Audio Loudness(LKFS), Mono/Blue only, Audio Channel, Safety marker size, Time code, Caption, Audio mute, Still image, Zoom, Flip, Gamma select, Vector Color, Fan Control, I/P Mode, Marker Preset1, Marker Preset2, WFM Line Select, PIP func & Input, Sub win full, Sub win part
FUNCTION 2	
FUNCTION 3	
FUNCTION 4	
FUNCTION 5	
FUNCTION 6	
MARKER	▶ Draw Marker on Screen ( Off -> 16:9 -> 4:3 ... -> 2.35:1 )
SCAN	▶ Executes Scan function ( Over-Scan -> Zero-Scan -> Under Scan-> Pixel to Pixel)
SDI 1	▶ Select SDI 1 source directly
SDI 2	▶ Select SDI 2 source directly
ANALOG	▶ Select ANALOG source directly ( `Composite1` ->`Composite2` ->`Composite3` -> `S-video` -> `B.R` -> `Y.Pb.Pr` -> `PC` -> `HDMI` -> `DVI`)
Adjust	▶ Adjust Picture Menu(Brightness -> Contrast -> Color -> Sharpness->Phase & Tint) ▶ Turn Right (with `UP` button is same) ▶ Turn Left (with `DOWN` button is same)

- **Front panel LED Operations**

- Green Led turned on during execution of key Function and Power On
- Stan-by mode is LED Red

- **Speaker Out**

Interface	Description
Speaker R out	8 ohm±15%, Max 2W + 2W
Speaker L out	

## 2. Rear Panel



- **Connection Details**

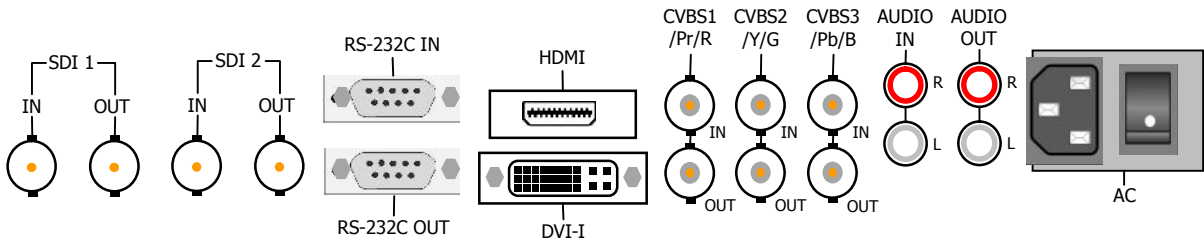

- **DC Battery IN (PRM-224→24V)**

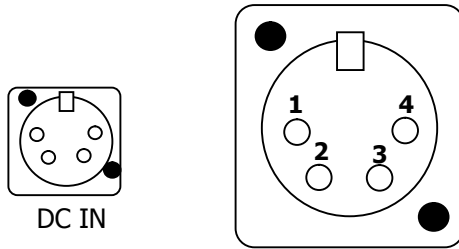

PIN NO	Description
1	GND
2, 3	
4	+ 12V/24V

- **RJ-45**

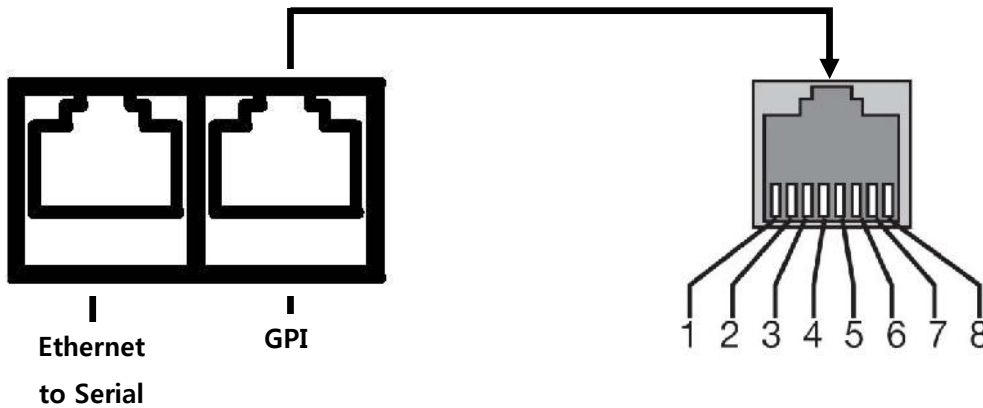

- Firmware Upgrade & GPI

Remote PIN Assignment			
1 PIN	COMMON(GND)	5 PIN	GPI 4 PORT
2 PIN	GPI 7 PORT (STAND BY/POWER ON/OFF)	6 PIN	GPI 3 PORT
3 PIN	GPI 6 PORT	7 PIN	GPI 2 PORT
4 PIN	GPI 5 PORT	8 PIN	GPI 1 PORT

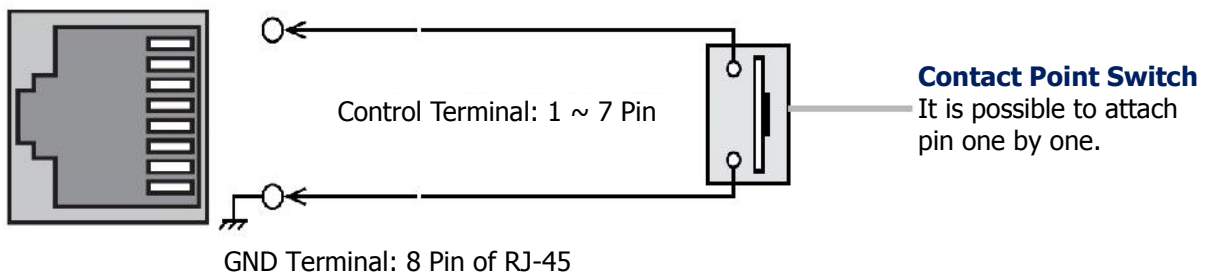

- **Interface description**

<b>Interface</b>	<b>Description</b>
SDI 1 IN	HD SDI / SD SDI Input
SDI 2 IN	
SDI 1 OUT	SDI 1, SDI 2 Loop Out
SDI 2 OUT	
RS-232 IN	Update/Multi Control/Auto color calibration
RS-232 OUT	Multi Control out
HDMI	High Definition Multimedia Input
DVI-I	DVI-I Type Digital / Analog PC-RGB Video Input High Definition Multimedia Input Compatible
CVBS1/Pr/R In	GBR (SOG sync) Input
CVBS2/Y/G/Y In	Y, Pb, Pr Component Video Input
CVBS3/Pb/B/C In	CVBS / Composite/S-Video Input
CVBS1/Pr/R Out	Component/GBR/Composite1,2,3/ S-Video Loop Out
CVBS2/Y/G/Y Out	
CVBS3/Pb/B/C Out	
AUDIO R In	DVI-I/Component/GBR/Composite1,2,3/S-Video Sound Input
AUDIO L In	
AUDIO R Out	AUDIO MONITOR OUT
AUDIO L Out	
AC IN	AC90V ~ 240V, 50Hz/60Hz
DC IN	PRM-217: DC 11V ~ 17V ,PRM-224: DC 24V
UPDATE	Firmware Upgrade
GPI	GPI 1 ~ 7 Control Port

## ***4. MENU OVERVIEW***

In this system menu, there are several ways to customize the menu settings provided. Most menus consist of three levels to select the option, but some require greater depth for the variety of settings. If you press the **MENU** button, only the first and second level of the menu system will appear on the monitor screen. The third level can be displayed by pressing **SEL/INPUT**. If a menu has more than three levels, the pop-up dialogue box will be displayed as the fourth or fifth level.

### ***1. To show and remove the Menu***

Press the **MENU** button to display the menu. Press the **MENU** button again will take you back to monitor viewing.

### ***2. To go to the next level***

Press **SEL/INPUT** button.

### 3. To go back to the previous level

Press **MENU** button



### 4. Typical Menu Operation

1. Press **MENU** button: The main menu will appear.
2. Use **UP/DOWN** button to select the desired menu option (icon).
3. While the desired menu option is selected, press **SEL/INPUT** to move to the second level.
4. Use **UP/DOWN** button to select the second menu option.
5. Press **SEL/INPUT** to move to the third level: Some menu options require additional steps.
6. Press **MENU** to return to the previous menu to return to monitor viewing.

## 5. BASIC OPERATION

### 1. Turning On the Monitor

1. First, connect power cord correctly. At this moment, the monitor switches to standby or power on mode. In standby mode, in order to turn monitor on, press and hold down the **ST-BY** button for 3 sec.
2. Select the viewing source by using **SEL/INPUT** button on Keypad in front of monitor

### 2. Volume Adjustment

1. Press the **UP/DOWN** button on Keypad.
2. If you want to switch the sound off, press the **FUNCTION (Audio mute)** button.
3. You can cancel this function by pressing the **FUNCTION (Audio mute)** or volume control button.

### 3. On Screen Menus Language Selection



- SETUP -> On Screen Display -> OSD Option -> Language
- The menu can be shown on the screen in the selected language.
- Supported Language: English, Spanish, Portuguese, German, French, Italian, Hindi



## 6. On Screen Menus Selection and Adjustment

### 1. How to adjust the OSD screen

1. Press the **MENU** button and then **UP/DOWN** button to select each menu.
2. Press the **SEL/INPUT** button and then use **UP/DOWN (SEL/INPUT)/MENU** button to display the available menus.

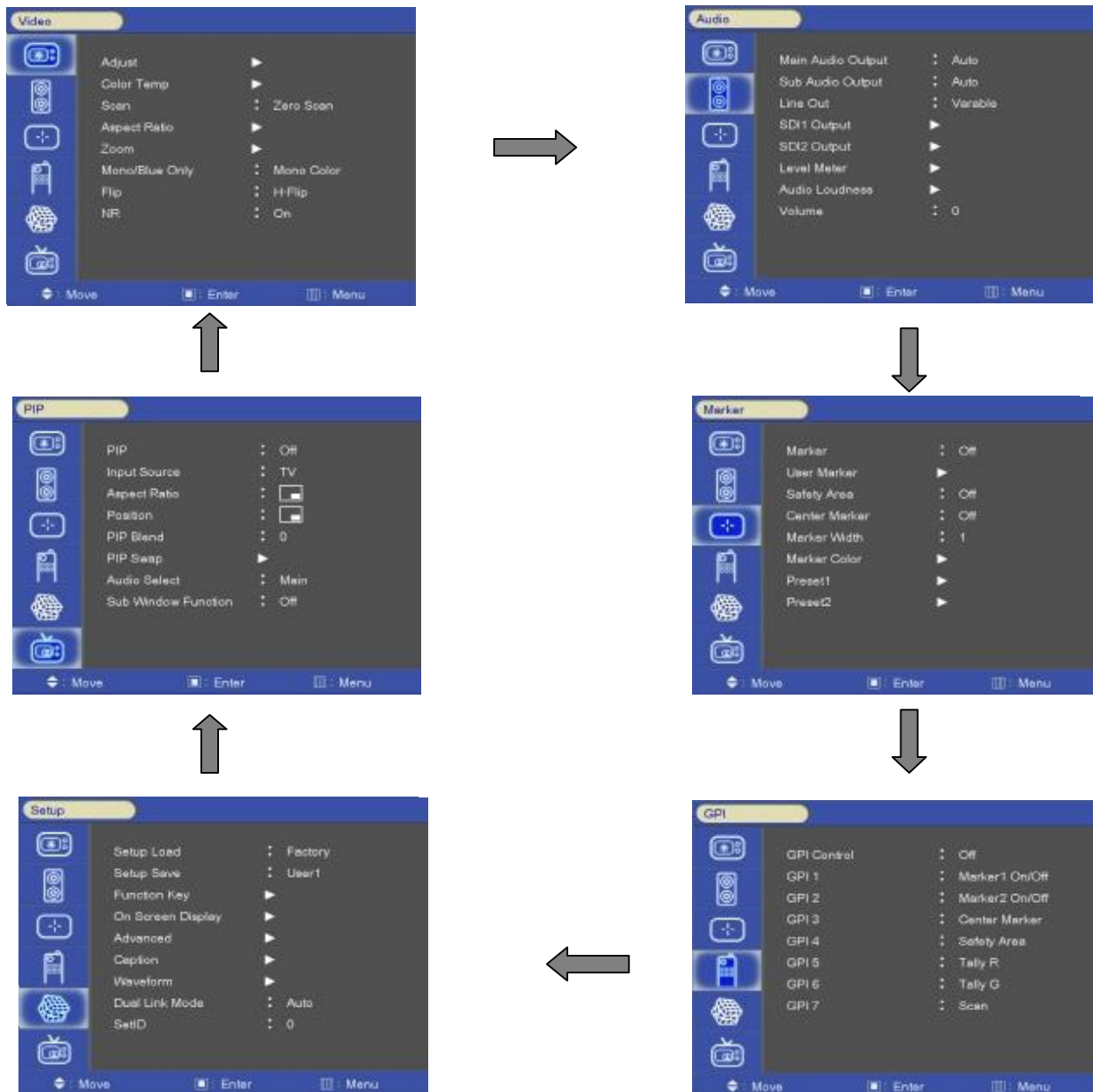

- Your monitor's OSD (On Screen Display) may differ slightly from what is shown in this manual.



## ***7. SELECT VIDEO INPUT***

### ***1. How to Select Video Source by OSD***

1. Press the **SET/INPUT** button and then **UP/DOWN** button to select each video source.
2. Press the **SET/INPUT** button to go to desired video source.
3. If Input Name is enabled, The **SET/INPUT** button goes into input name edit mode instead of selecting source.

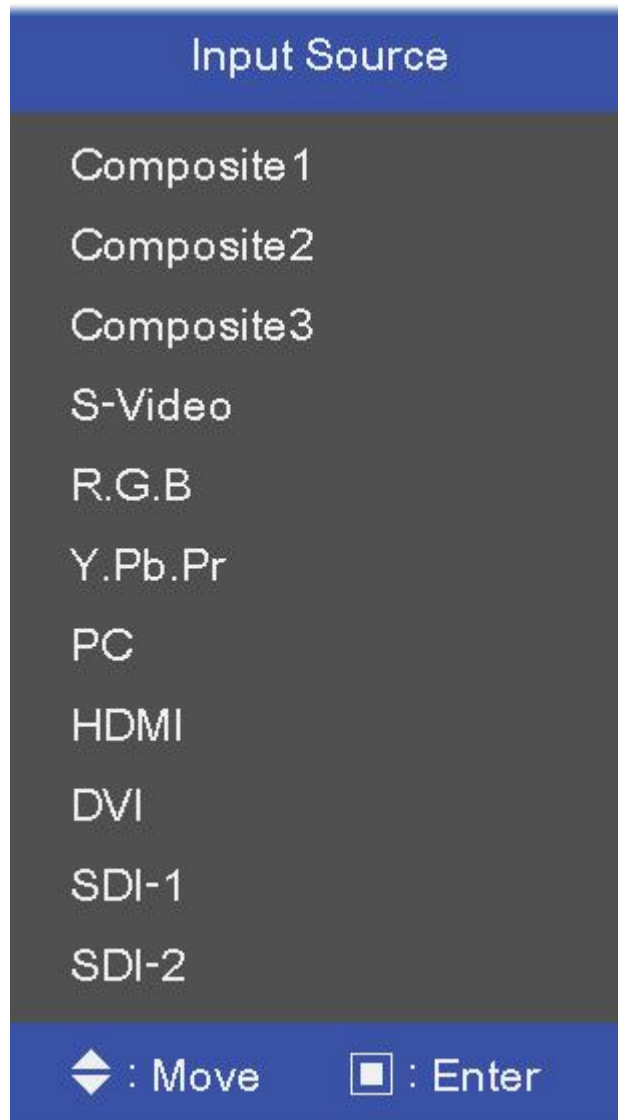

## 8. PICTURE MENU OPTIONS

### 1. Video Menus of each Input modes



< Video (NTSC) Picture menu >



< PC Picture menu >



< SDI, HDMI Picture menu >

### 2. Adjust



- Adjust the values of Brightness, Contrast, Color, Tint and Sharpness directly from -50 to 50
- Contrast, Brightness, Sharpness, Color (All Sources), Tint (without PC, DVI, HDMI, Component), Phase (Component).

### 3. Color Temperature Control



- For Setting the Color temperature or adjusting RGB gain value directly
- User (User setting RGB gain value), VAR(3200K ~ 11000K), Often used value(11000K, 9300K, 6500K, 5400K, 3200K) and 3D LUT Calibration value(D65 – 6504K/C-6774K/D-Cinema 6302K)

## 4. SCAN



1. Over Scan – 95% input size and fit the selected display size
2. Zero Scan – 100% Input size and fit the selected display size
3. Under Scan – 105% Input size and fit the selected display size
3. Pixel to Pixel – Display size is an input size. If input resolution is bigger than panel size, fit the panel size

## 5. Aspect Ratio



- For setting the aspect ratio.
- Full Screen: The images are displayed with a panel size.
- Full Screen, 16:9, 4:3, 14:9, 13:9, 1.85:1, 2.35:1: The images are displayed with each aspect ratio.
- Function-key operate Rotation, Full Screen, 16:9, 4:3, 14:9, 13:9, 1.85:1, 2.35:1
- AFD function Added
- PC mode: Full Screen & 4:3 only

## 6. Zoom



- Can see the enlarged picture by (2X, 3X, 4X, 5X) ratios.
- If user select the Zoom 2X, can see the below yellow box in picture.
- Press Select or Enter button, user can see the enlarged picture.
- Menu key escape the zoom mode.

- Example (3X3)



Zoom X position: Coordinate of video image's column position.  
Zoom Y position: Coordinate of video image's row position.

### 7. Mono/Blue Only



- Mono color: For selecting monochrome images.
- Blue Only: Images have only blue color expect red and green color

### 8. PC Menu (pc mode only)

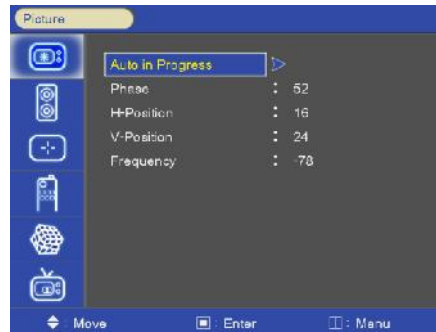
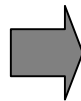
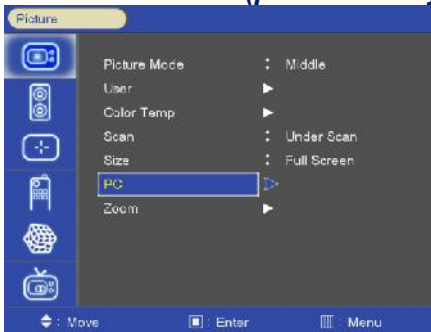

- Only operate PC input mode
- Select Auto-adjust and adjust Phase, HV position, Frequency
- Auto-Adjust automatically set the optimum values of Phase, HV position and Frequency.

## 9. Flip



< H-Flip Off >



< H-Flip On >

-H-Flip Display ON/OFF

## 10. NR (Noise Reduction)

-Noise Reduction on/off. (NR is for Video signal (HD-SDI, Composite, S-Video and Y.Pb.Pr) & DTV timing.

# 9. AUDIO MENU OPTIONS

## 1. MAIN / SUB Audio out



-Main: Select Internal Speaker out. (Auto/SDI1/SDI2/HDMI/Line in)

-Sub: Select sub display sound. (Auto/SDI1/SDI2/HDMI/Line in)

## 2. SDI 1/ SDI 2 Audio Output Channel

- Audio output channel source select. (Channel1~4, Channel1/2, Channel3/4, off)

## 3. SDI 1, /SDI 2 Audio Group

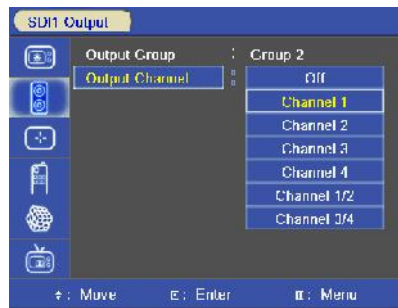
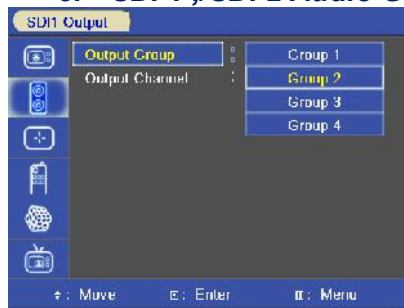

- Select primary or secondary audio group to extract. (Group 1~4)

#### 4. Level Meter



- Display the audio level meter on screen in SDI input.



-Pair: Respectively Channel with right and left display

-Group: Respectively group display



-- Level Meter Position selects. (TOP/Bottom)



- Level Meter Scale mode selects. (BBC / EBU / VU / NORDIC / DIGITAL / DIN / EXPAND DIN)

## AUDIO SCALES

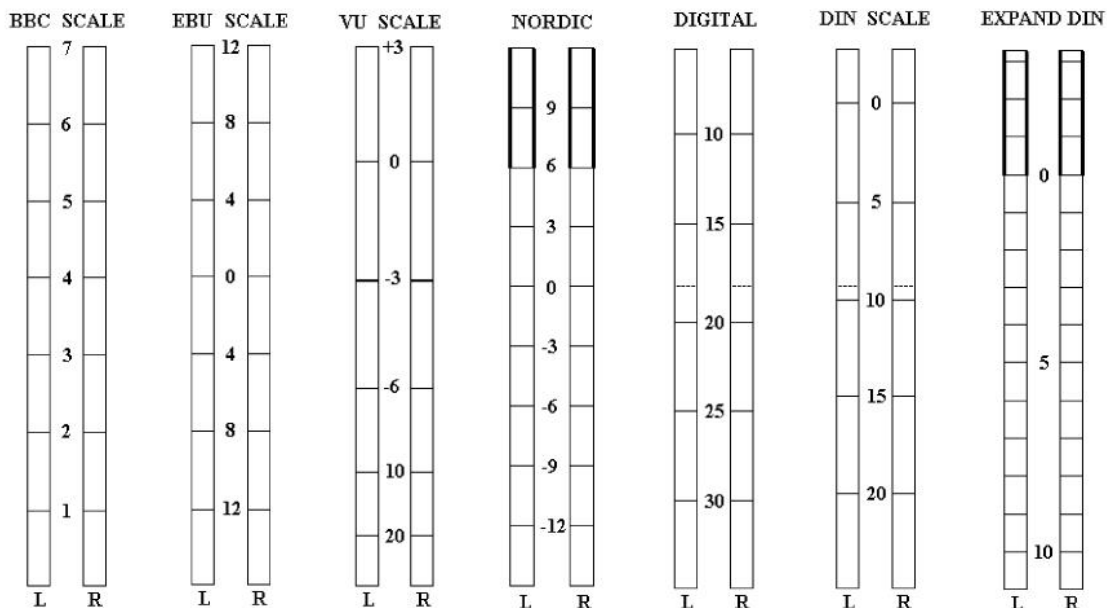

-Level Meter Size select. (Small, Large)

### 5. Audio Loudness



-Audio Loudness setting (On, Off) and Set Target(LKFS)



## 6. Volume

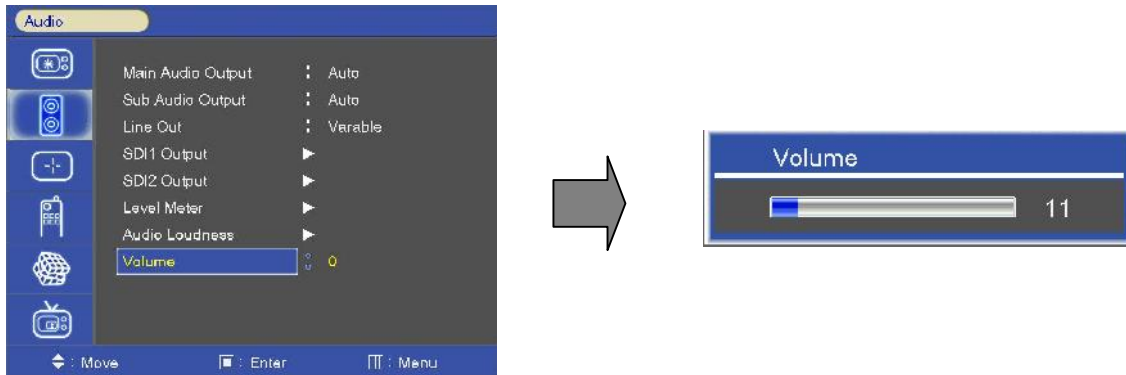

- Adjust the speaker or headphone Volume level. (0~100)

# 10. Marker MENU OPTIONS

## 1. Marker & User Marker



< Marker >



< User Marker >

1. Marker : 16:9, 4:3, 14:9, 13:9, 1.85:1, 2.35:1, 1.85:1&4:3, User1, User2, User3 fitted panel size marker on screen.

2. User Marker: The user wants Marker size setting. (Below panel size)  
Example (1440x900 panel)



16:9 (16:9 Marker)



16:9 (4:3 Marker)



## 2. Safety Area



-Safety Area: Draw dotted line Marker on screen in case of images.  
(16:9 95/93/90/88/80%, 4:3 95/93/90/88/80%, EBU Action 16:9/14:9/4:3, EBU Graphic 16:9/14:9/4:3)

## 3. Center Maker

- "+" Marker on center of screen



## 4. Marker Width

-Marker line thickness setting. (0~10)

## 5. Marker Color



- Marker Line Color: Select Marker line color (White, Yellow, Blue, RED, Black)
- Safety Line Color: Select Safety line color (White, Yellow, Blue, RED, Black)
- Marker Back Color: Select Marker Back Color. (None, Gray, White, Blue, Black)
- Safety Back Color: Select Safety Back Color. (None, Gray, White, Blue, Black)
- Marker BK Blend Color: Select Marker blending level. (0 ~ 5)
- Safety BK Blend Color: Select Safety blending level. (0 ~ 5)

## 6. Preset1 & Preset2

- For setting the marker to use by GPI controller.
- GPI preset markers are only worked by GPI controller

# 11. GPI MENU OPTIONS

## 1. GPI Control & GPI#

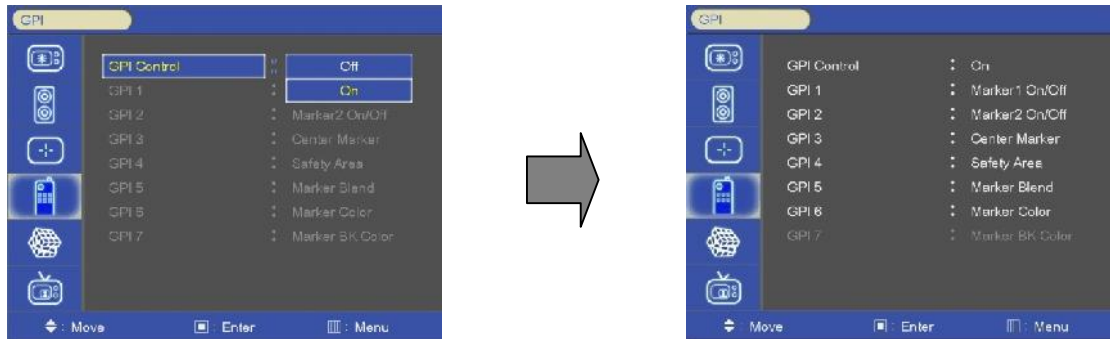

- For allocating functions to particular GPI pins.
- When remote control operations are to be performed using the GPI Controller.
- GPI Control: GPI function Enable/Disable
- GPI 1 ~ 7

GPI Function	Description
UNDEF	Not set (no function allocated)
Marker1 On/Off, Marker2 On/Off	Displays the markers which have been set by the GPI PRESET1, 2 items on the screen.
Center Marker	Displays the center marker.
Safety Area	Displays the Safety Area.
Tally R, Tally G	For lighting up the Red or Green tally lamp.
Scan	Over Scan/Zero Scan/Under Scan/ Pixel to Pixel
Input Composite1,2,3 Input R.G.B, Input SDI1, Input SDI2, Input Y.Pb.Pr , Input PC , Input DVI, Input HDMI	Switches the input source.
Menu Key, Enter Key, Up Key, Down Key Left Key, Right Key	Use the key function by GPI.
Function key1 ~ 6	
H/V delay	H delay, V delay, HV delay, Off
Aspect	Full Screen, 16:9, 4:3, 14:9, 13:9, 1.85:1, 2.35:1
Waveform	Display the Waveform
GPI 7 : Power Key(Fixed)	

## 12. SETUP MENU OPTIONS

### 1. Setup Load & Setup Save

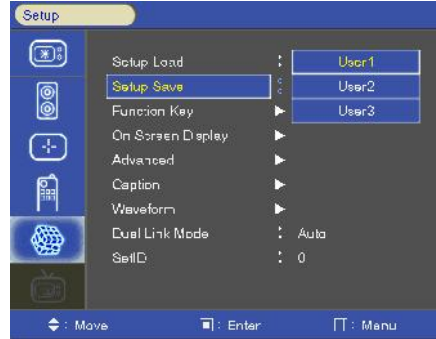

- Setup Load: Load user saved values or default value
- Setup Save: Save user setting values at user 1, 2, 3.

### 2. Function 1 ~6



- Function 1~6 : Select the function to be allocated to the FUNCTION 1, 2, 3, 4, 5, 6 buttons

Function1~6 button	Description
UNDEF	Not set (no function allocated)
Marker size	Marker size Select
Audio Lv Meter	Audio Lv Meter On / Off
Wf/Vector	Display the Waveform
H/V delay	H delay, V delay, HV delay, Off
Aspect	Sets the aspect ratio of the images
Audio Loudness	Display Audio Loudness
Mono/Blue Only	Execute Mono color or Blue Only
Audio Channel	Select the extract the embedded audio channel in SDI input.
Safety Area Marker	Safety Area Select
Time Code	Time Code Display
Caption	Closed Caption (Analog Signal only)
Audio mute	Toggles sound status of speaker/headphone in mute.
Still image	Toggles picture status between motion and still image.

Zoom	Zoom function is operated(Off, 2x, 3x, 4x, 5x)
Flip	H-Flip Display on/off
Gamma Select	Select Gamma curve.
Vector Color	Vector Color 100% or 75%
Fan Control	Fan Auto, On, Off
I/P Mode	Field Merge, Line Doubler, Inter-Field
Marker Prese1/2	Marker Prese1/2 on/off
Wfm Line Select	Wfm Line On/ Off
PIP func & Input	Pip Enable and Select input pip source
Sub win full	Display the same full images on POP1 screen
Sub win part	First image scale 4:3 aspect ratio and then display on POP2 screen

### 3. On Screen Display

- **OSD Option**

- Language: Select a language for the menus to appear in. (English, Spanish, Portuguese, German, French, Italian)
- OSD Position: L-T, R-T, C, L-B, R-B
- OSD Transparency: Disable blending OSD background with video image.
- OSD Time out: OSD gone time setting. (3~200)

- **Time code**

- Time code Enable: Time code Display (off/LTC/DVITC, SDI only)
- Time code size: Time code size select. (Small, Middle, Large)
- Time code Position: Time code display position selects (L-T, C-T, R-T, L-B, C-B, R-B)
- Time code Transparency: Disable blending Timecode background with video image. (0%, 25%, 50%, 75%, 100%)

- **Under Monitor Display (color: Tally R/G mode action )**



UMD



Tally Red



Tally Green

- UMD: UMD display on/off
- UMD Character: UMD Character Select
- UMD Position: UMD display position select(L-T, C-T, R-T, L-B, C-B, R-B)
- UMD FG Color: UMD Character color Select (RGB\_255\_192\_128\_Transpareut)
- UMD BG Color: UMD BG color Select (RGB\_255\_192\_128\_Transpareut)

- **Input ID**

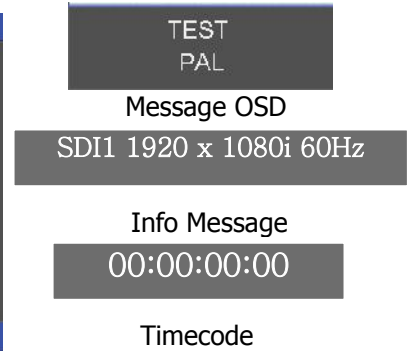
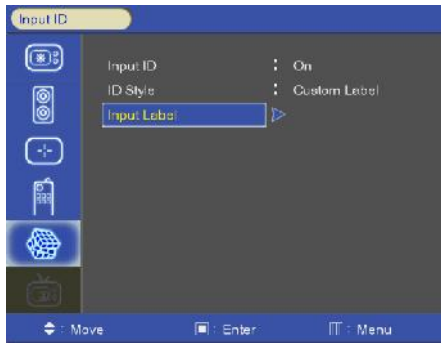

→Input ID: source Message display.

→ID Style: select "Input Format"/"Custom Label"

→Input Label: Display user made name instead of input source name on source OSD and message OSD

- **SDI Signal state**

SDI Signal date display on/off (H/V sync, image, Audio, Audio Phase, EDH packet, EDH FF CRC, EDH APCRC, SAC, EAV, VPI)

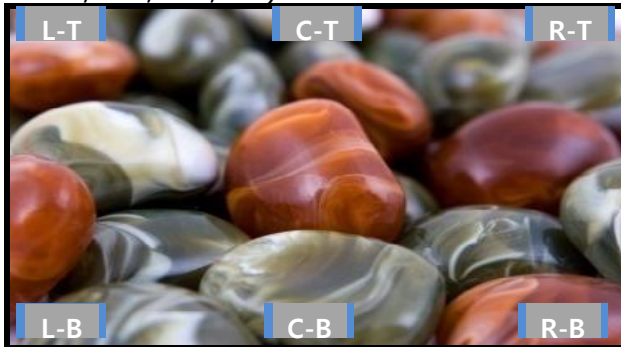

#### 4. **Advanced**



– Information, Control, Screen Saver, Screen Control, Fan Control, x786 Mode

- **Information**



- Version, Release day, Release time, operating time, FPGA Version, Calibration ID

- **Control**



- FRONT LED: Front LED on/off  
 - Local Enable: Power, up and down key is only worked, if Local enable is off.  
 - Remote Enable: Select the controller of local or remote. If remote controller is selected, both local (front key) and remote are worked. However select local, local key only operated.

- **Screen Saver**



- Blue Screen: Enables screen saver functions to avoid panel burning.  
 - BG Gray: Select gray level on besides display picture  
 - Power save Mode: DPMS (Display Power Management Signaling) Power Save Mode

### Screen Control



-Reset Calibration  
 →Color Calibration Reset  
 -Backlight Adjust  
 →Inverter dimming Level select (0~100)  
 -Gamma Select  
 →Gamma Level Select (0.8 ~ 3.0)  
 -Deinterlacer  
 → Deinterlacer function on/off  
 -Dithering  
 → Dithering function on/off

- Internal Pattern:

→100% Color Bars, 75% Color Bars, Luma, RGB, White, Black, RED, Blue, Green

### • Fan Control



→ Fan Control: Internal Fan Controls driving option by temperature sensor **Auto** / force **on** / force **off**

→ Fan Active Temperature: Adjusts fan driving temperature by Celsius degree. It works only when the Fan Control setting is Auto.

→ Hysteresis: Adjusts fan driving hysteresis temperature by Celsius degree. (1~10°C)

→ Shutdown: For a monitor protection is above of 75 °C, Power Off.

→ MCU Fan Control: Control main MCU Fan On/Off

### • X768 Mode



-Selects X768 native PC video timings. (Auto/1024x/1280x/1360x/1366x)

## 5. Caption

→Closed Caption: 608 Line21, 608 ANC, 608 Transcoded mode Select



- 608 Caption mode Select. (C/C1, C/C2, C/C3, C/C4, TEXT1, TEXT2, TEXT3, TEXT4, OFF)



## 6. Waveform Format (only SDI model)

Press the **WAVEFORM** button to display the WAVEFORM Mode

- **Y-Pb-Pr Waveform**



- Y\_Pb\_Pr WAVEFORM & Audio Lever Meter & Info Window & Time code Display.

- **Y-Waveform + Vector Scope**



- WAVEFORM & Vector Scope & Audio Lever Meter & Info Window & Time code Display.



- **Double**

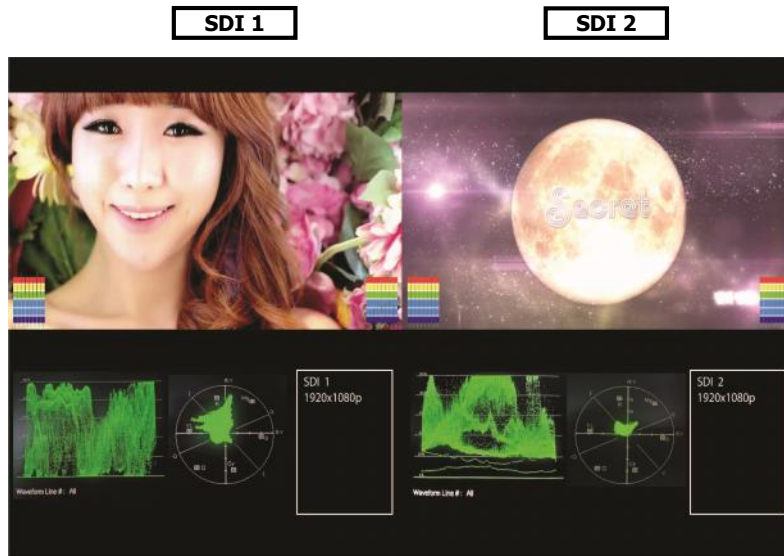

- SDI 1, 2 & WAVEFORM & Vector Scope & Audio Level Meter & Info Window.

- **Y-Waveform + Vector Scope Trans**



- WAVEFORM & Vector Scope Trans.

- **Vector Color**

- Vector color: Select 100% or 75%

- **Line Select**

- Select line WAVEFORM & Vector Scope display.

- line select : 1~540

- **Line #**

-line select

- **Line Display**

-off/on/5 sec

### 7. **Dual Link Mode(SDI only)**

-Dual Link Mode select. (Auto/Off/RGB444/YCbCr444/YCbCr422/Progreddive)

### 8. **Set ID & Active Set ID**

- If control each Board, must set ID numbers of each Board (01~99).

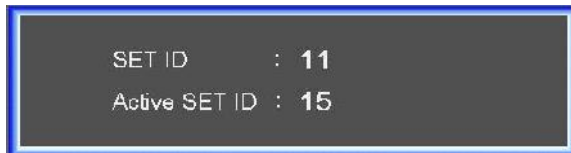

- Set Active SET ID number Before Control each Board by Remote control or RS-232  
 - If control only 15<sup>th</sup> Board, Active SET ID must set 15.

## 13. **PIP (Picture In Picture)**

- Watch two programs or source at the same time. And set up PIP size and position.

- Only Dual Link model Select

### 1. **PIP ON/OFF**



- Control PIP function On/Off.

### 2. **Input Source**

- PIP input Source can operate with different signal and type.

- Analog (Composite1, 2, 3, Y.Pb.Pr, GBR, PC) inputs + Digital (DVI, HDMI) + SDI (SDI1, SDI2) inputs

-SDI + SDI input PIP

Ex) AV + S-Video (X), DVI + SDI (O), PC + DVI (O), SDI1+SDI2 (O)

### 3. Aspect Ratio

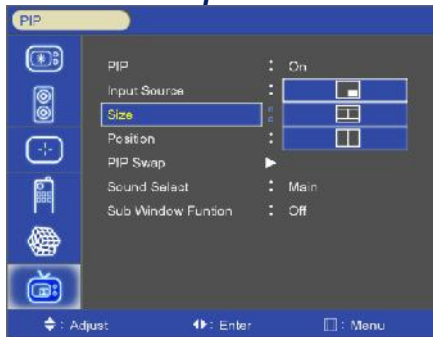

- Choose PIP size of Small/POP1/POP2



PIP Small

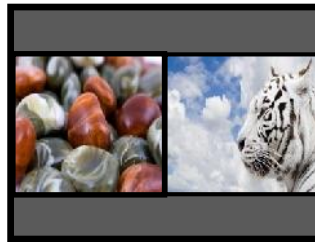

PIP1



POP2

### 4. Position

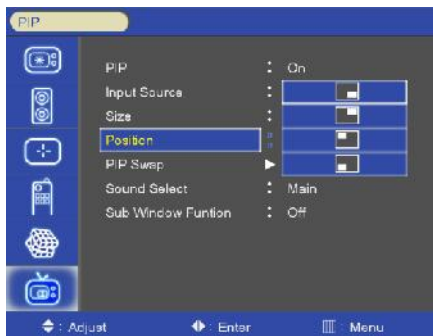

- Choose the pip position on the each corner of the pane

## 5. PIP Blend



-Blend to PIP size of Small

## 6. PIP Swap

- Using Swap option, you can exchange two programs or source at the same time.

## 7. Sound Select

- Using Sound Swap option, you can exchange the sound of two programs or source at the same time.

## 8. Sub Window Function



- Full Sub Window: Display the same full images on POP1 screen.
- Part Sub Window: First image scale 4:3 aspect ratio and then display on POP2 screen.
- FULL, Part function is only used in Digital input (SDI1, SDI2, DVI, HDMI)



Sub Window Full



Sub Window Part

## ***14. OSD TREE***

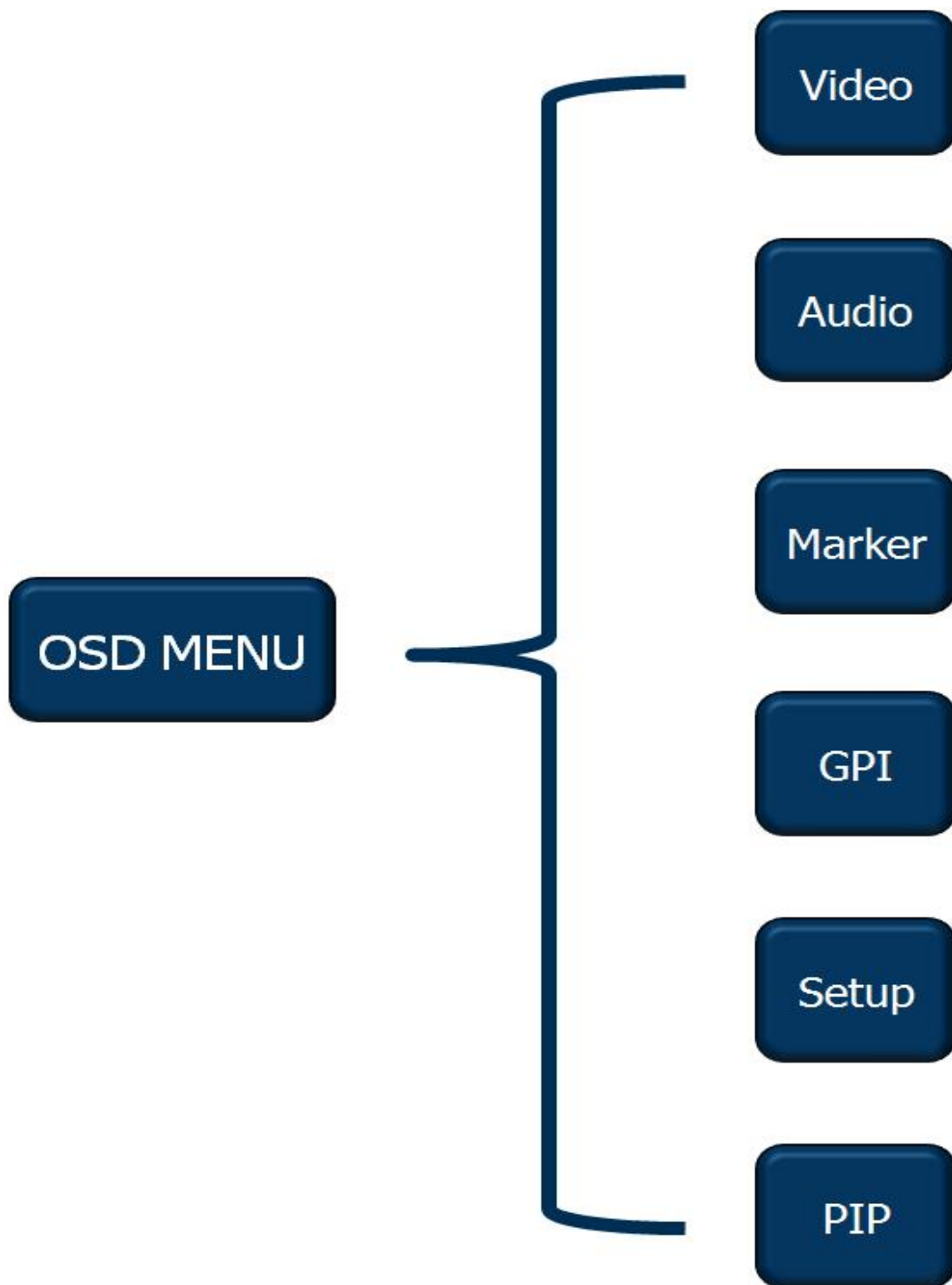

## 1. Video

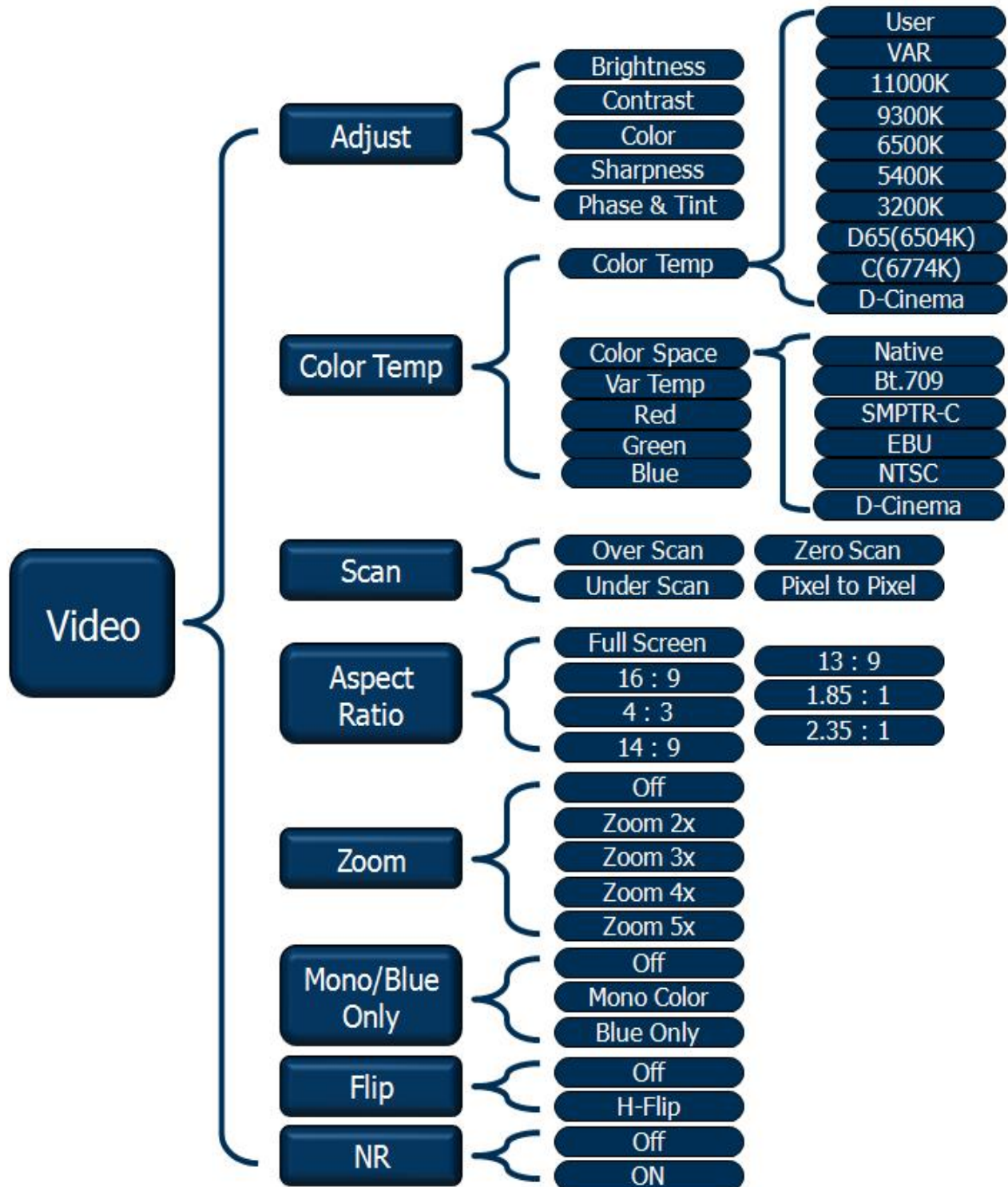



## 2. Audio

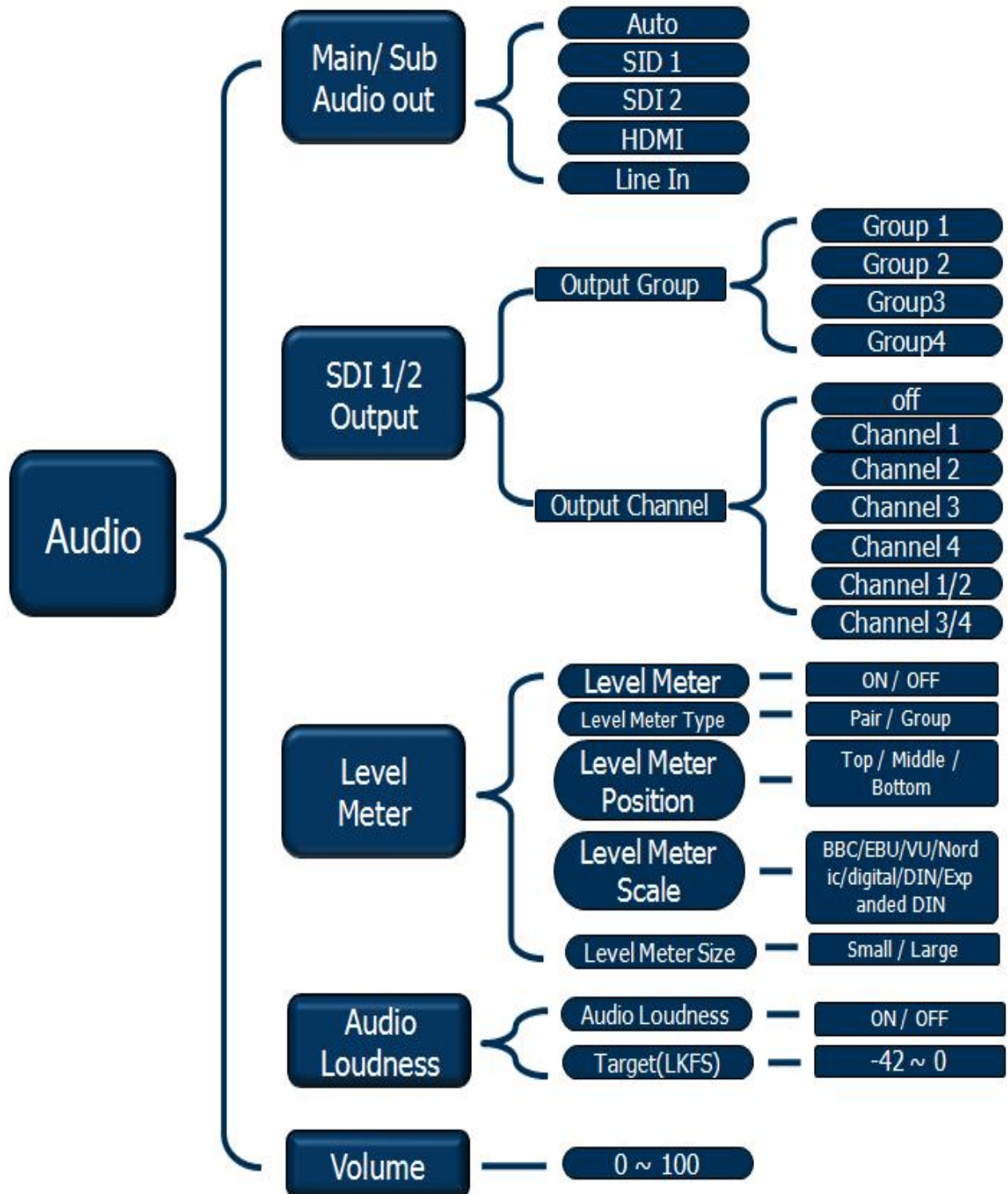

### 3. Marker

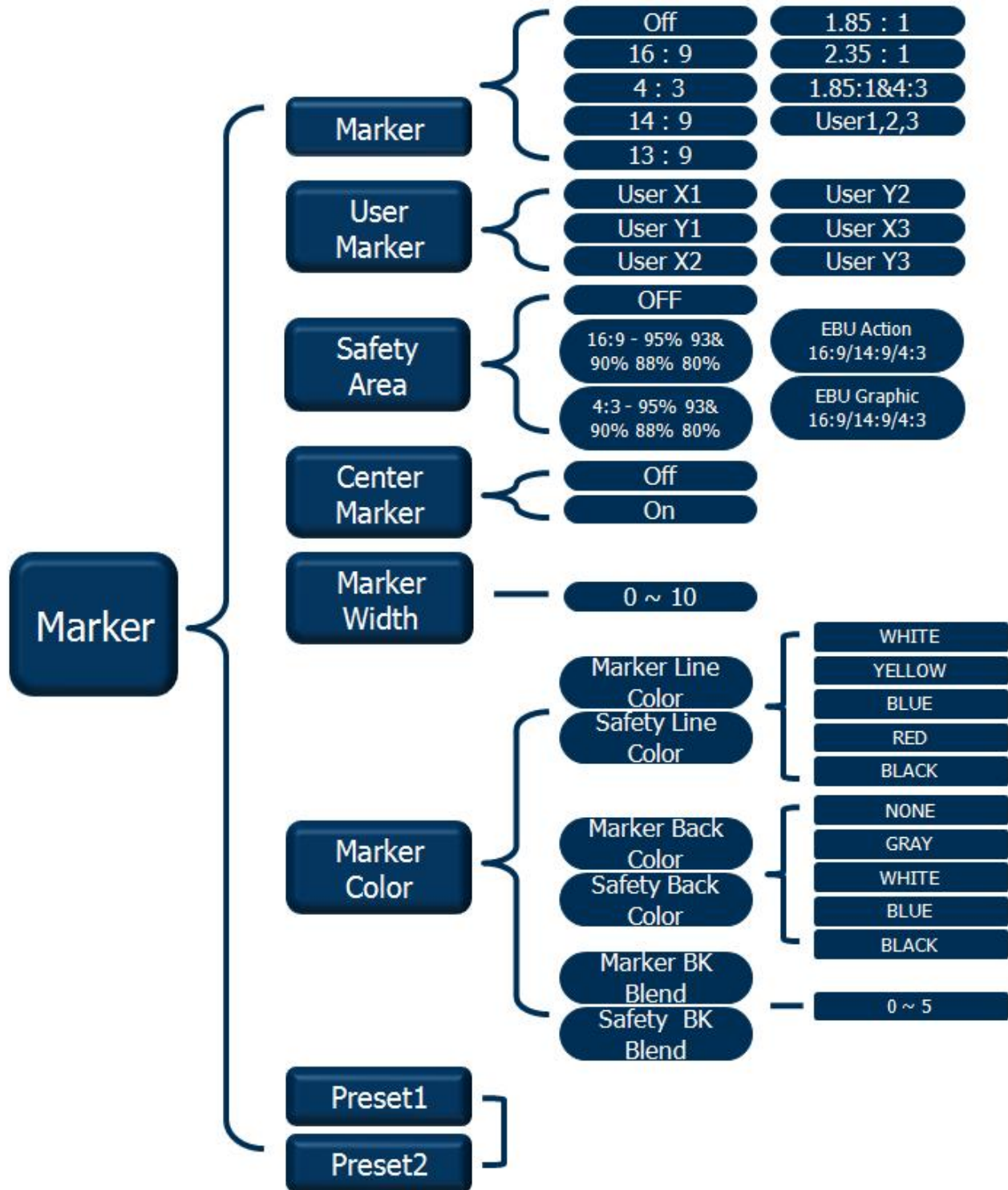



#### 4. GPI

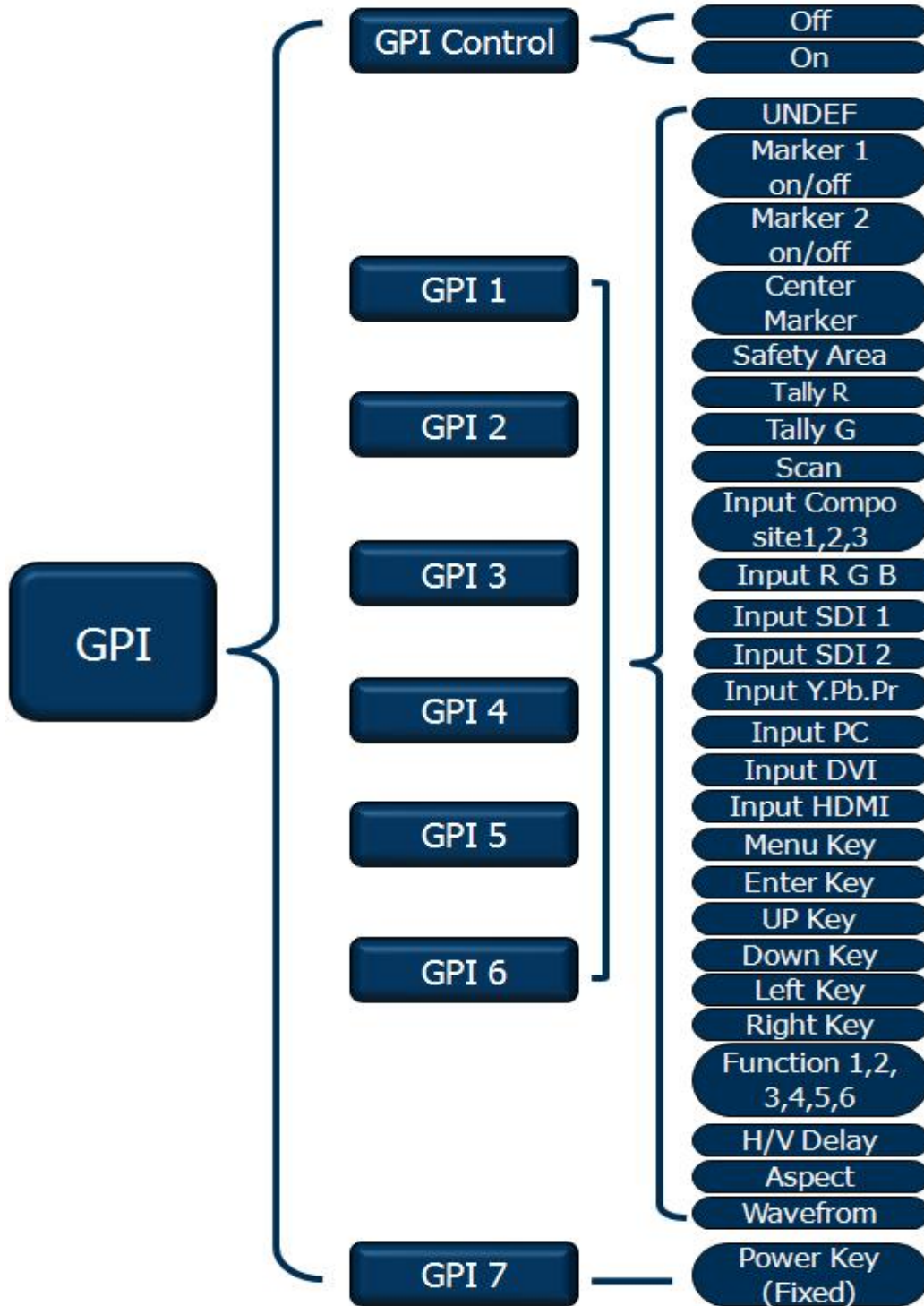

## 5. Setup

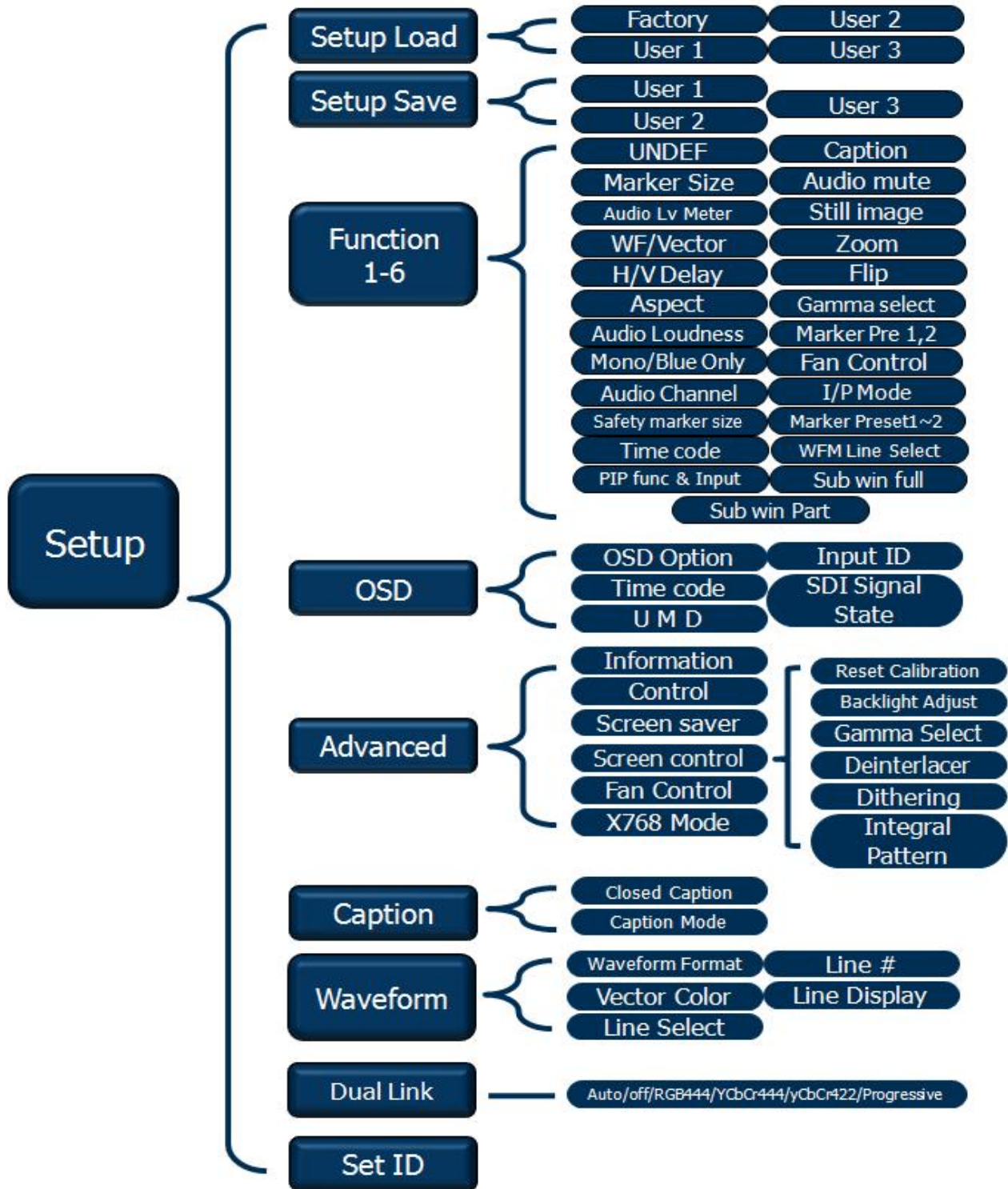

## 6. PIP

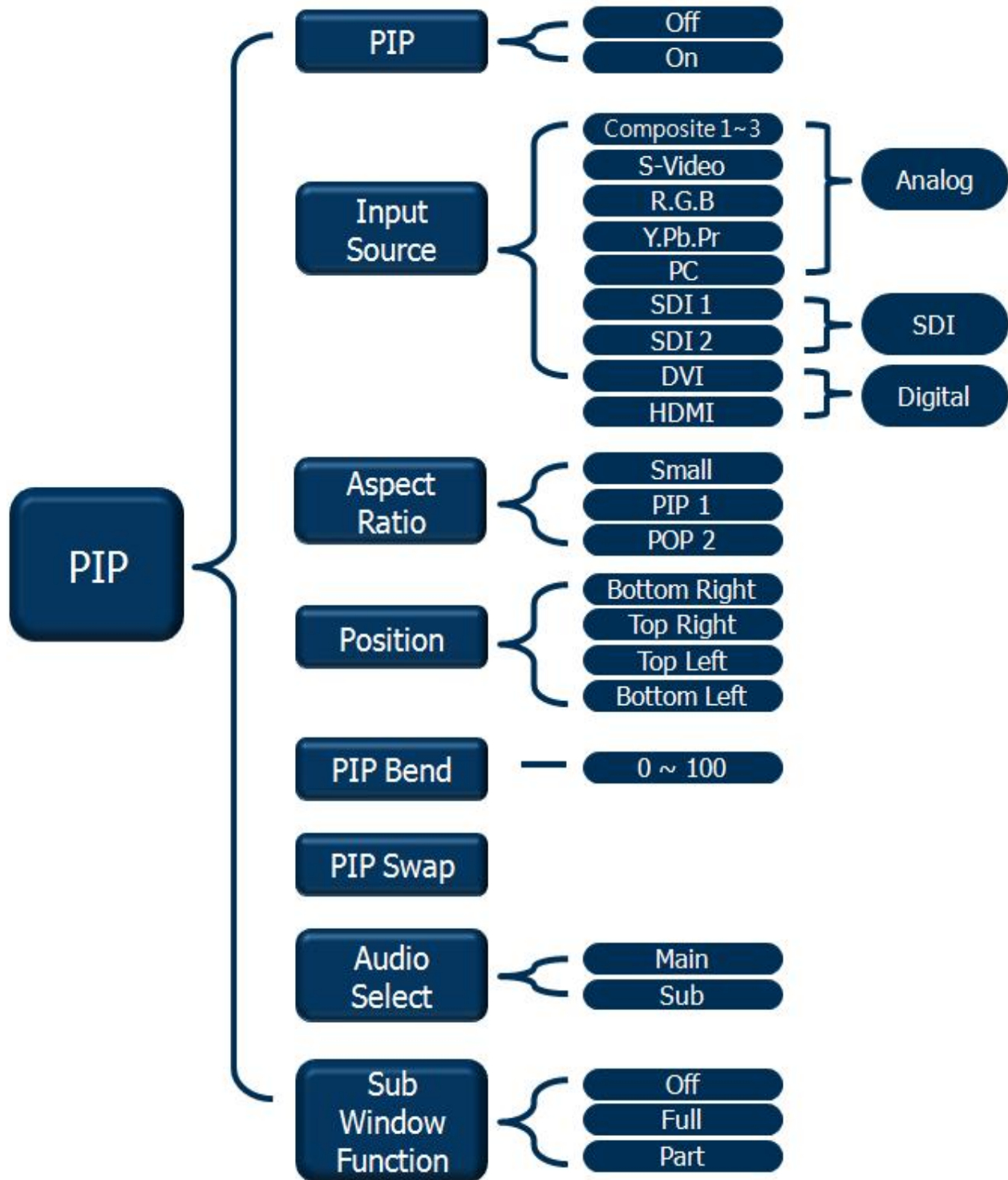

# 15. Mechanical Dimension

## 1. PRM-217-3G

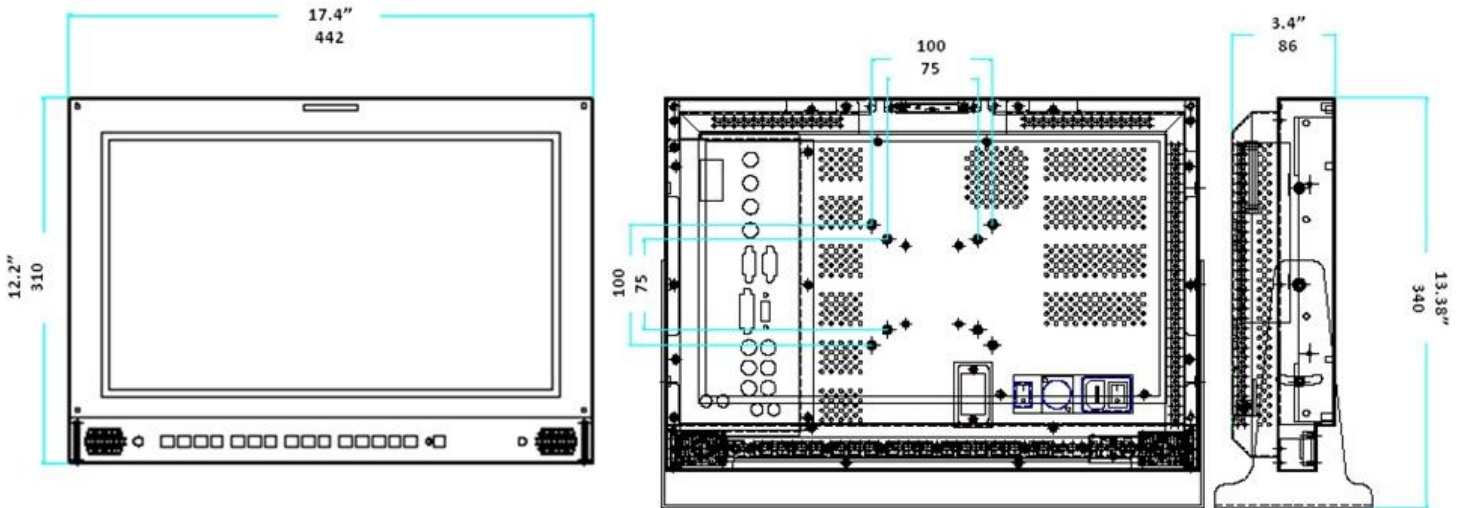

## 2. PRM-224-3G

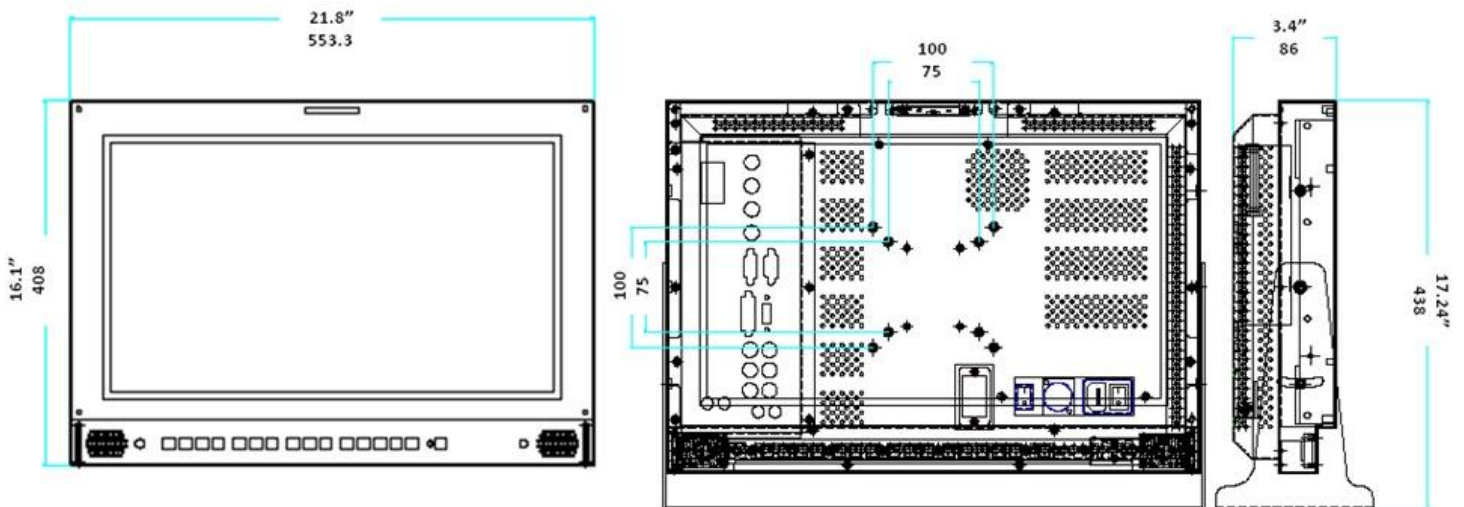



3. **PRM-232-3G**

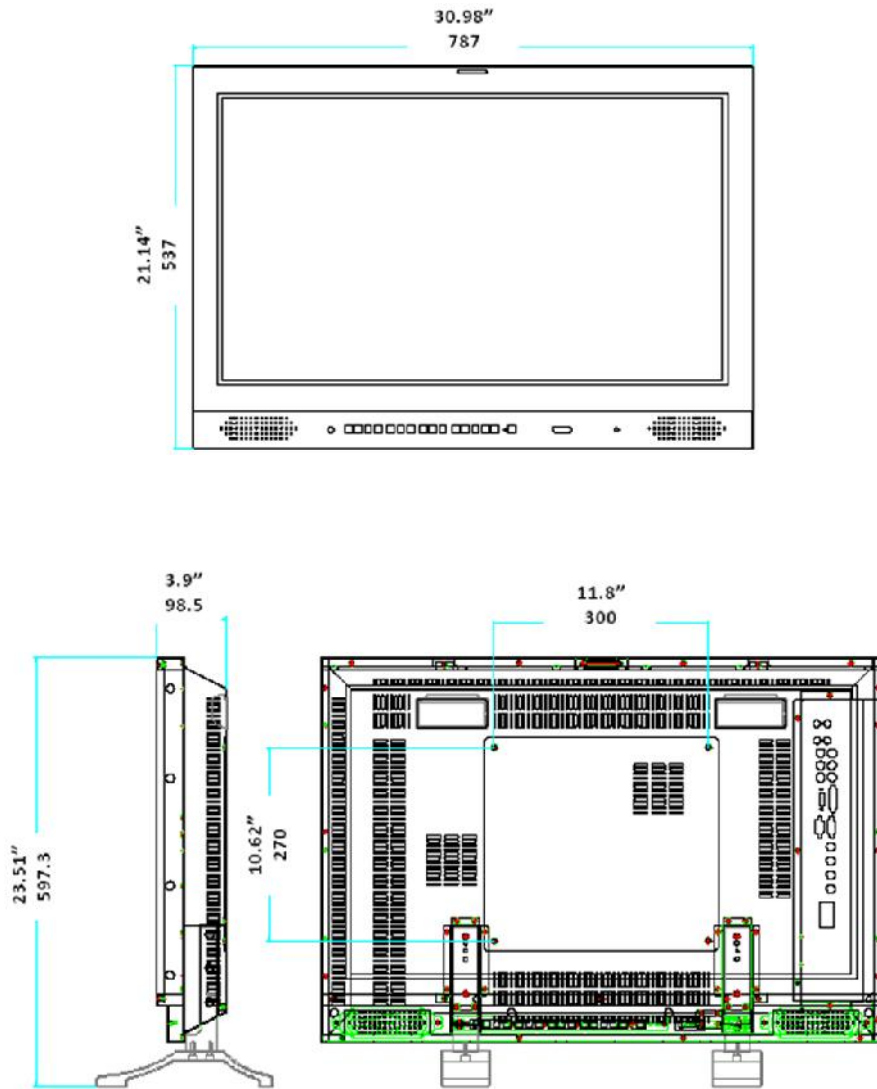

# plura<sup>®</sup>

[www.plurabroadcast.com](http://www.plurabroadcast.com)

**Plura Broadcast, Inc. - West Coast**

1930 W. Quail Ave  
Phoenix, AZ 85027  
Tel: (602) 944-1044  
Fax: (602) 324-9688

**Plura Broadcast, Inc. - East Coast**

67 Grand avenue  
Massapequa, NY 1175  
Tel: (516) 997-5675  
Fax: (516) 593-7900