

# plura<sup>®</sup>

## Operating Instructions

SFP-3G Series Monitors



**SFP-3G Series**

**SFP-217-3G**

**SFP-221-3G**

**SFP-224-3G**

**SFP-232-3G**

<b>PRECAUTION</b> -----	<b>6</b>
<b>1. OVERVIEW</b> -----	<b>9</b>
<b>2. GENERAL FEATURES</b> -----	<b>9</b>
<b>3. FUNCTIONAL EXPLANATION OF EACH PART</b> -----	<b>10</b>
1) FRONT PANEL -----	10
● <i>SFP-217-3G</i> -----	10
● <i>Front Keys Arrangements</i> -----	10
● <i>Front Keys Operations</i> -----	11
● <i>SFP Module Information</i> -----	11
● <i>Front panel LED Operations</i> -----	12
● <i>Speaker Out</i> -----	12
2) REAR PANEL (CONNECTOR) -----	12
● <i>DC Battery IN</i> -----	12
● <i>RJ-45</i> -----	12
● <i>Interface description</i> -----	13
<b>4. MENU OVERVIEW</b> -----	<b>14</b>
1) TO SHOW AND REMOVE THE MENU -----	14
2) TO GO TO THE NEXT LEVEL -----	14
3) TO GO BACK TO THE PREVIOUS LEVEL -----	14
4) TYPICAL MENU OPERATION -----	14
<b>5. BASIC OPERATION</b> -----	<b>14</b>
1) TURNING ON THE MONITOR-----	14
2) VOLUME ADJUSTMENT -----	14
3) ON SCREEN MENUS LANGUAGE SELECTION-----	15
<b>6. ON SCREEN MENUS SELECTION AND ADJUSTMENT</b> -----	<b>15</b>
1) HOW TO ADJUST THE OSD SCREEN -----	15
<b>7. SELECT VIDEO INPUT</b> -----	<b>16</b>
1) HOW TO SELECT VIDEO SOURCE BY OSD-----	16
<b>8. PICTURE MENU OPTIONS</b> -----	<b>17</b>
1) VIDEO MENUS OF EACH INPUT MODES -----	17

2) ADJUST-----	17
3) COLOR TEMPERATURE CONTROL -----	17
4) SCAN -----	18
5) ASPECT RATIO -----	18
6) ZOOM-----	18
7) MONO/BLUE ONLY -----	19
8) PC MENU (PC MODE ONLY) -----	19
9) FLIP -----	19
10) NR (NOISE REDUCTION) -----	19
11) SFP SETTING-----	20
<b>9. SOUND MENU OPTIONS -----</b>	<b>20</b>
1) MAIN / SUB AUDIO OUT-----	20
2) SDI MAIN/ SDI SUB AUDIO OUTPUT CHANNEL -----	20
3) SDI MAIN/ SDI SUB AUDIO GROUP -----	20
4) LEVEL METER -----	21
5) LEVEL METER TYPE-----	21
6) LEVEL METER POSITION -----	21
7) LEVEL METER SCALE-----	21
8) VOLUME-----	22
<b>10. MARKER MENU OPTIONS-----</b>	<b>22</b>
1) MARKER & USER MARKER-----	22
2) SAFETY AREA -----	23
3) CENTER MAKER-----	23
4) MARKER WIDTH -----	23
5) MARKER COLOR -----	23
6) PRESET1 & PRESET2 -----	23
<b>11. GPI MENU OPTIONS-----</b>	<b>24</b>
1) GPI CONTROL & GPI# -----	24
<b>12. SETUP MENU OPTIONS -----</b>	<b>25</b>
1) SETUP LOAD & SETUP SAVE -----	25
2) FUNCTION 1 & FUNCTION 2 & FUNCTION 3 -----	25
3) ON SCREEN DISPLAY -----	26

●	<i>OSD Option</i> -----	26
●	<i>Time code</i> -----	26
●	<i>Under Monitor Display (color: Tally R/G mode action )</i> -----	26
●	<i>Input ID</i> -----	26
●	<i>SDI Signal state</i> -----	27
4)	ADVANCED -----	27
●	<i>Information</i> -----	27
●	<i>Control</i> -----	27
●	<i>Screen Saver</i> -----	28
●	<i>Screen Control</i> -----	28
●	<i>Fan Control</i> -----	28
●	<i>Network Config</i> -----	28
●	<i>X768 Mode</i> -----	29
5)	CAPTION -----	29
6)	WAVEFORM FORMAT (SDI ONLY) -----	30
●	<i>Y-Pb-Pr Waveform</i> -----	30
●	<i>Y-Waveform + Vector Scope</i> -----	30
●	<i>Double</i> -----	31
●	<i>Y-Waveform + Vector Scope Trans</i> -----	31
●	<i>Vector Color</i> -----	31
●	<i>Line Select</i> -----	31
●	<i>Line #</i> -----	31
●	<i>Line Display</i> -----	32
7)	DUAL LINK MODE (SDI ONLY) -----	32
8)	SET ID & ACTIVE SET ID -----	32
<b>13.</b>	<b>PIP (PICTURE IN PICTURE)</b> -----	<b>32</b>
1)	PIP ON/OFF-----	32
2)	INPUT SOURCE-----	32
3)	ASPECT RATIO -----	32
4)	POSITION-----	33
5)	PIP BLEND -----	33
6)	PIP SWAP -----	33
7)	SOUND SELECT -----	34
8)	SUB WINDOW FUNCTION -----	34

<b>14. OSD TREE</b>	<b>35</b>
1) PICTURE	36
2) SOUND	37
3) MARKER	38
4) GPI	39
5) SETUP	40
6) PIP	41
<b>15. SUPPORTED INPUT MODES</b>	<b>42</b>
1) SUPPORTED SIGNALS	42
2) SUPPORTED TIMINGS	42
● SDI input	42
● PC & DVI input	43
3) SFP MODULES SUPPORTED	45
4) MECHANICAL DIMENSION	45
● SFP-217-3G, SFP-221-3G, SFP-224-3G, SFP-232-3G	45

## Precaution

*Before operating the set, please read this manual carefully.*

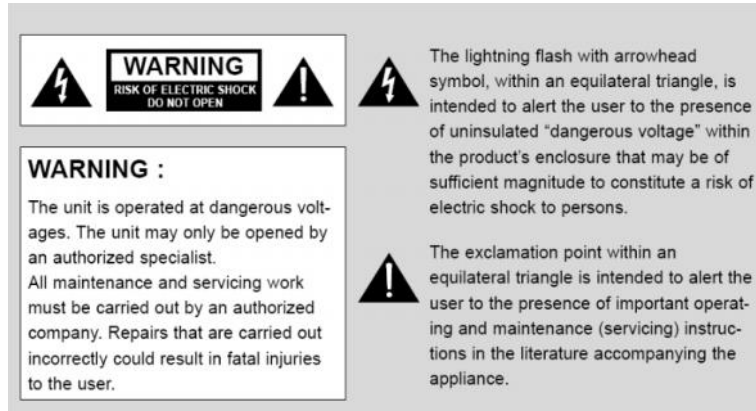

### **WARNING:**

To reduce the risk of any electric shock, do not remove back cover as there are no user serviceable parts inside. Please refer to Plura or a qualified service personnel/agent. To prevent fire or shock hazard, do not expose the rear side of the unit to rain or moisture. Do not rub or clean the Active Matrix LCD with any harsh surface as this may scratch, mark, or damage the Active Matrix LCD permanently.

### **CAUTION:**

Unauthorized tampering with the inside of the monitor voids the warranty. The manufacturer shall not warrant for any damage caused by improper maintenance and/or repair by any third party. Important safeguards for you and your new product: Please read and observe the following safety points when installing and using your new device and save them for future reference.

*1. Read Instructions*

*2. Follow Instructions*

*All operating and use instructions should be followed.*

*3. Retain Instructions*

*The safety and operating instructions should be retained for future reference.*

*4. Observe Warnings*

*All warnings on the product and in the operating instructions should be adhered to.*

*5. Cleaning*

*Disconnect the unit from the mains before cleaning. Do not use abrasive cleaners. Use a damp cloth for cleaning.*

**6. Water and Moisture**

*Do not use this unit near water.*

**7. Transportation**

*A product should be transported with care. Excessive force and uneven surfaces may cause the damage to product.*

**8. Attachments**

*Do not use attachments not recommended by Plura as they may cause hazards.*

**9. Ventilation**

*Do not block any of the ventilation openings.  
Install in accordance with the manufacturer's instructions.*

**10. Power Sources**

*This product should be operated only from the type of power source indicated on the marking label. If you are not sure of the type of power supply, consult your power company.*

**11. Power Lead Polarization**

*This product is equipped with a three-wire grounding-type cord. This is a safety feature. Do not use an alternative power cord.*

**12. Power Cord Protection**

*Power-supply cords should be protected so that they are not likely to be walked on or pinched by items placed upon or against them, paying particular attention to cords at plugs, convenience receptacles and the point where they exit from the product.*

**13. Outdoor Cable Grounding**

*If an outdoor cable is connected to the product, be sure the cable is grounded to provide some protection against voltage surges and built-up static charges. A "face plate" also needs to be installed with an isolating capacitor to prevent any damage from static.*

**14. Lightning**

*For added protection for this product during a lightning storm, or when it is left unattended and unused for long periods of time, unplug it from the wall outlet. This will prevent possible damage to the product due to lightning and power-line surges.*

**15. Earthing the product**

*This product must be earthed properly to comply with the safety regulations in the country of use. If you are unsure of these regulations, please consult a qualified electrician.*

**16. Servicing**

*Do not attempt to service this product yourself as opening or removing covers may*

expose you to dangerous voltages or other hazards. Refer all servicing to qualified service personnel. If the device does not operate properly, switch it off and call your dealer.

### 17. Service

Turn this product off, unplug from the mains supply and refer servicing to qualified service personnel under the following conditions:

- A. If the power-supply cord or plug is damaged.
- B. If the LCD has been damaged.
- C. If water or moisture penetrated the glass and/or the LCD screen.
- D. If the product does not operate normally by following the operating instructions. Adjust only those controls that are covered by the operating instructions as an improper adjustment of other controls may result in damage and will often require extensive work by a qualified technician to restore the product to its normal operation.
- E. If the product has been dropped or the frame has been damaged.
- F. If the product exhibits a distinct change in performance.

### 18. Safety Check

Upon completion of any service or repairs to this product, ask the service technician to perform safety checks to determine that the product is in proper operating condition and the front seal is intact.

### 19. Mounting

The product should be mounted on a wall only as recommended in the instructions.

### 20. Power

This device operates on an AC supply; the voltage is as indicated on the label on the Manual. This device must be earthed at all times through the chassis as well as through the power lead.



Note

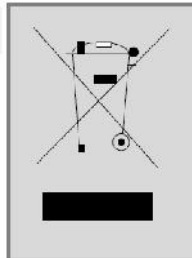

This product is designed and manufactured with high quality materials and components which can be recycled and reused. This symbol means that electrical and electronic equipment, at their end-of-life, should be disposed of separately from your household waste. Please, dispose of this equipment at your local community waste collection/recycling centre. In the European Union there are separate collection systems for used electrical and electronic product. Please, help us to conserve the environment we live in!



## **1. OVERVIEW**

New Plura SFP-217-3G, SFP-221-3G, SFP-224-3G & SFP-232-3G, 17", 21", 24" & 32" FULL HD 1920x1080 Precision Broadcast LCD Series is built with high quality panel respectively. The SFP-3G series adapt to various PLURA SFP modules which can fit any possible broadcast application. It supports up to 3Gbps-1080-60P along with all other Digital & Analog inputs & formats. The SFP-3G series is capable of converting the SD/HD/3G input to HDMI output.

## **2. GENERAL FEATURES**

- SFP Modules 4 Slot (6 Input / 6 Output)
- SFP Modules type – BNC, Optical, HDMI(Output only)
- WAVEFORM / Vector Scope / Time code Display.
- 16 CH Audio Level Meter Display. (SDI only)
- Analog & Digital Signal Audio Level Meter Display.
- Closed Caption CEA608 & 708
- H Flip, H/V Delay.
- Audio Disembedder & Internal Speaker & Monitor out
- Color Temperature – User, VAR, 11000K, 9300K, 6500K, 5400K, 3200K
- Over Scan/Zero Scan/Under Scan/Pixel to Pixel
- PIP (Picture In Picture)/PIP Blend
- Tally LED function (Green/Red/AMBER)
- Integrated DVI (HDCP) function.
- HDMI (HDCP) function.
- Supports VESA DDC2B and a subset of VESA standards.
- Supported External GPI Control (RJ-45).
- OSD: Graphic based OSD, 6 Languages (UNICODE System).
- LCD Dimming Control
- Manual Dimming Level Control.
- Rack Mount (OPTION)
- UMD
- Auto Calibration: CA-310(Minolta) / K-10(Klein)
- ETHERNET: Network System Controller / Update

### 3. Functional explanation of each part

#### 1) Front Panel

- SFP-217-3G

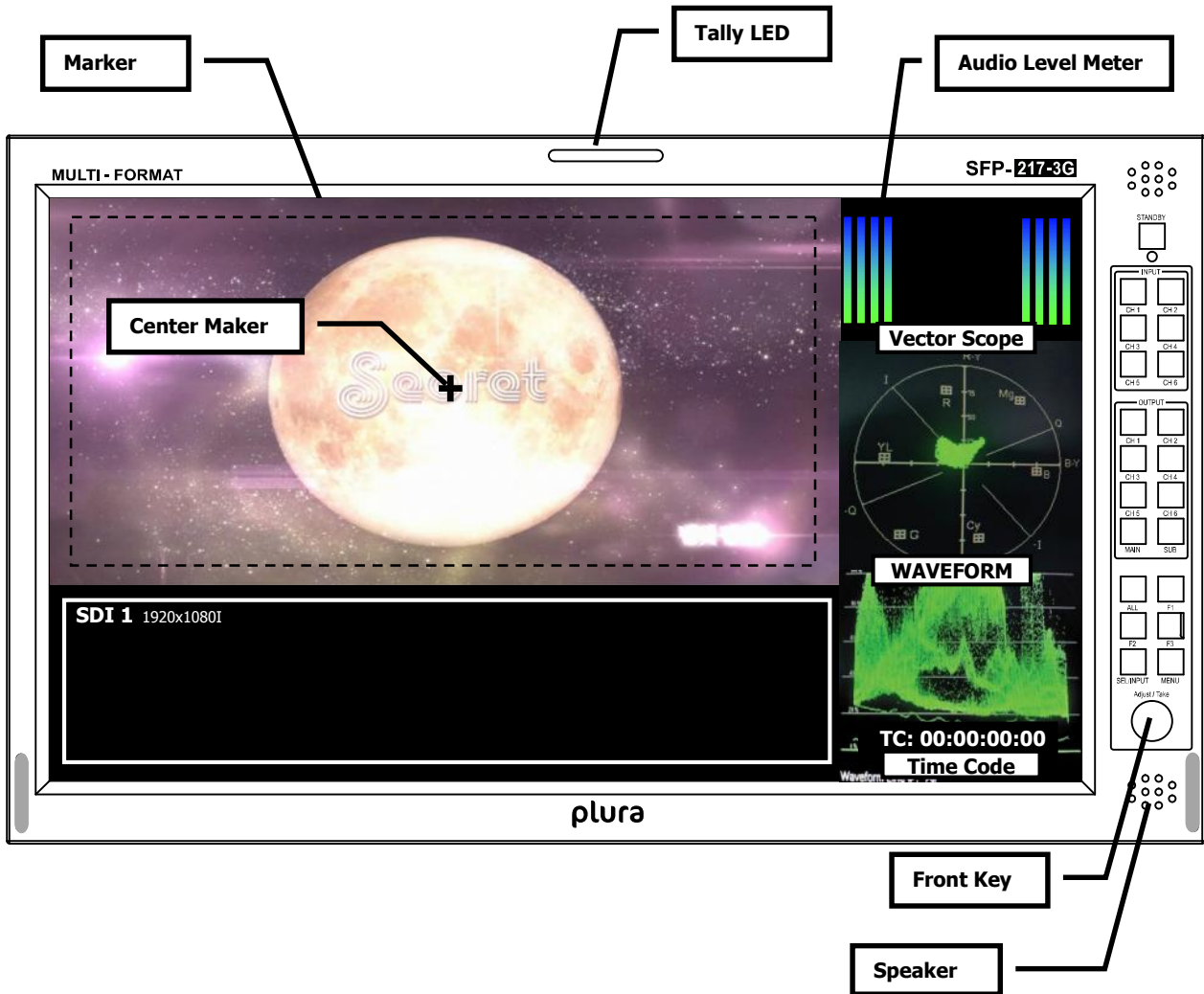

- Front Keys Arrangements

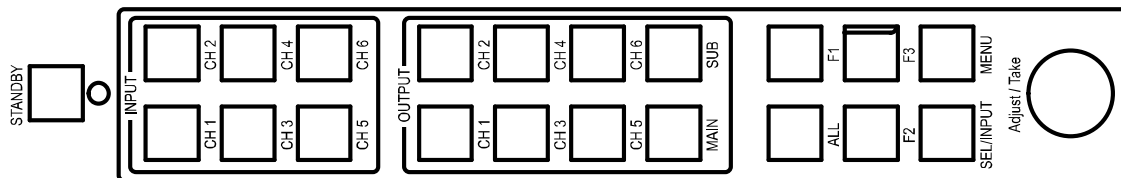

● **Front Keys Operations**

Key Name	Operation
STANDBY	▶Power ON/OFF Button. This button is operated after being pressed about 3 seconds.
INPUT CH1/CH2/CH3/CH4/CH5/CH6	▶SFP Modules Input CH selected. ▶Channels in the input signal, the key led light.
OUTPUT CH1/CH2/CH3/CH4/CH5/CH6/ MAIN/SUB	▶SFP Modules Output CH selected.
ALL	▶SFP Modules ALL Output CH selected.
FUNCTION F1/F2/F3	▶Executes functions of user selected. UNDEF, Aspect, Mono/Blue only, Audio Channel, Safety area marker, Time code, Analog Caption, Audio mute, Still image, Zoom, Flip, Gamma select, PIP func & Input, Sub win full, Sub win part
SEL/INPUT	▶Activates OSD menu of input source selecting. ▶Changes input source by selecting. ▶Executes functions (by OSD help commands) in main OSD menu. ▶Activates child menu.
MENU	▶ Activates main OSD menu. ▶ Navigates higher menu in main OSD menu. ▶ Exits OSD menu.
Adjust / Take	▶Adjust Picture Menu(Brightness -> Contrast -> Color -> Sharpness->Phase & Tint) ▶Turn Right (with „UP' button is same) ▶Turn Left (with „DOWN' button is same)

● **SFP Module Information**

- Activates OUTPUT key ch1~6 or ALL key

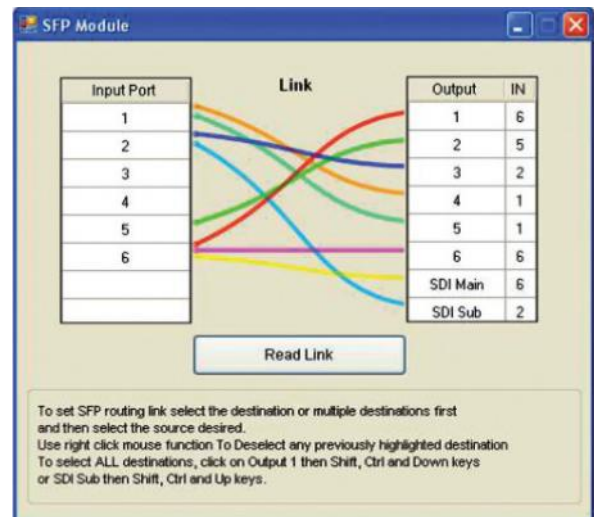
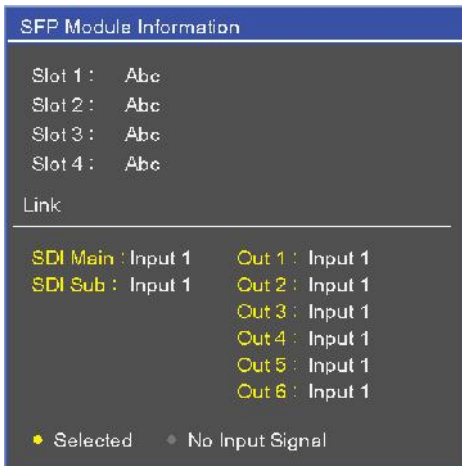

- Slot 1~4: SFP Module mounted information display.
- Out 1~6/ SDI Main/SDI Sub: Select the output signal. (input1~6)
- The selected output channel activation. (Yellow Color)
- Activated Channels in the input signal. (Yellow Color)

- **Front panel LED Operations**

- Stan-by mode is LED Red

- **Speaker Out**

Interface	Description
Speaker R/L out	8 ohm±15%, Max 1W + 1W

2) **Rear Panel (Connector)**

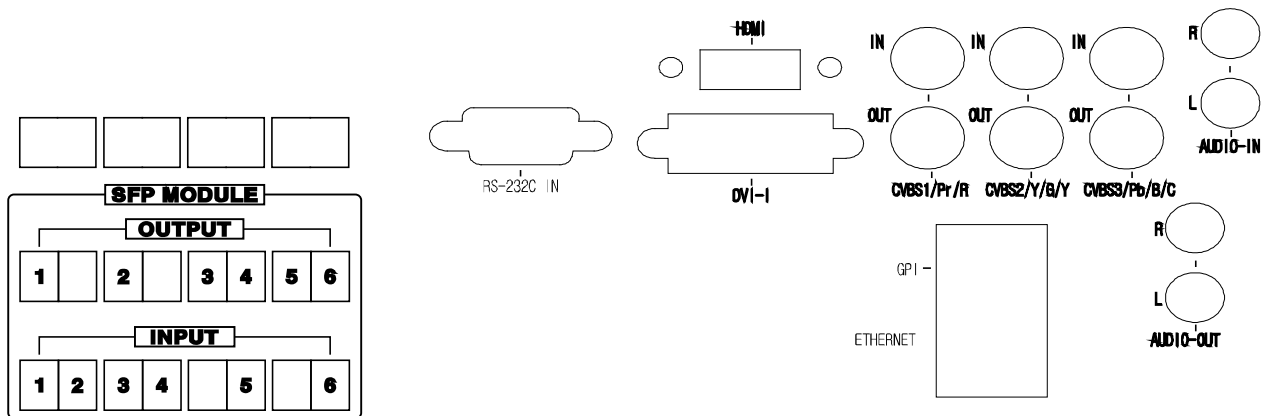

- **DC Battery IN**

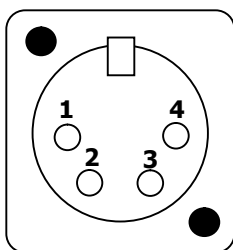

PIN NO	Description
1	GND
2, 3	
4	+ 12V

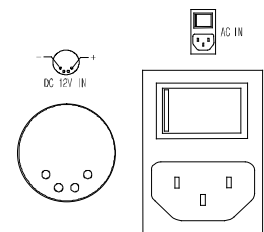

- **RJ-45**



- Firmware Upgrade/ System Controller (Ethernet) & GPI

Remote PIN Assignment			
1 PIN	COMMON(GND)	5 PIN	GPI 4 PORT
2 PIN	GPI 7 PORT (STAND BY/POWER ON/OFF)	6 PIN	GPI 3 PORT
3 PIN	GPI 6 PORT	7 PIN	GPI 2 PORT
4 PIN	GPI 5 PORT	8 PIN	GPI 1 PORT

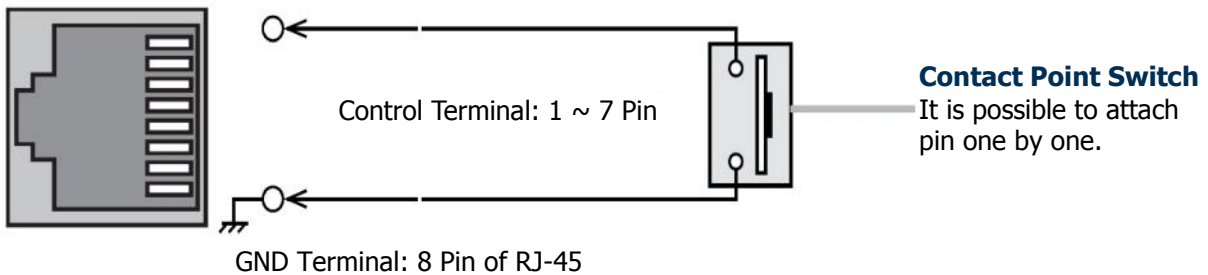

● **Interface description**

Interface	Description
SFP Module 4 Slot	Input ch 1/Output ch 1
	Input ch 2
	Input ch 3/Output ch 2
	Input ch 4
	Output ch 3
	Input ch 5/Output ch 4
	Output ch 5
	Input ch 6/Output ch 6
RS-232 IN	Update/Multi Control/Auto color calibration
HDMI	High Definition Multimedia Input
DVI-I	DVI-I Type Digital / Analog PC-RGB Video Input High Definition Multimedia Input Compatible
CVBS1/Pr/R In	GBR (SOG sync) Input
CVBS2/Y/G/Y In	Y, Pb, Pr Component Video Input
CVBS3/Pb/B/C In	CVBS / Composite/S-Video Input
CVBS1/Pr/R Out	Component/GBR/Composite1,2,3/ S-Video Loop Out
CVBS2/Y/G/Y Out	
CVBS3/Pb/B/C Out	
AUDIO R In	DVI-I/Component/GBR/Composite1,2,3/S-Video Sound Input
AUDIO L In	
AUDIO R Out	AUDIO MONITOR OUT
AUDIO L Out	
AC IN	AC90V ~ 240V, 50Hz/60Hz
DC IN	PBM-217: DC 11V ~ 17V ,PBM-224: DC 24V
ETHERNET UPDATE	ETHERNET/Firmware Upgrade
GPI	GPI 1 ~ 7 Control Port

## 4. MENU OVERVIEW

In this menu system, there are several ways to customize the menu settings provided.

Most menus consist of three levels to set up the options, but some require greater depth for the variety of settings. If you press the **MENU** button, only the first and second level of the menu system will appear on the monitor screen. The third level can be displayed by pressing **SEL/INPUT**. If a menu has more than three levels, the pop-up dialogue box will be displayed as the fourth or fifth level.

### 1) To show and remove the Menu

Press the **MENU** button to display the menu. A second press of the **MENU** button will take you back to monitor viewing.

### 2) To go to the next level

Press **SEL/INPUT** button.

### 3) To go back to the previous level

Press **MENU** button



### 4) Typical Menu Operation

1. Press **MENU** button: The main menu will appear.
2. Use **Adjust / Take** button Turn Right/ Left to select the desired menu option (icon).
3. While the desired menu option is selected, press **SEL/INPUT** to move to the second level.
4. Use **Adjust / Take** button Turn Right/ Left to select the second menu option.
5. Press **SEL/INPUT** to move to the third level: Some menu options require additional steps.
6. Press **MENU** to return to the previous menu to return to monitor viewing.

## 5. BASIC OPERATION

### 1) Turning On the Monitor

1. First, connect power cord correctly. At this moment, the monitor switches to standby or power on mode. In standby mode, in order to turn monitor on, press the **ST-BY** button.
2. Select the viewing source by using **SEL/INPUT** button on Keypad in front of monitor

### 2) Volume Adjustment

1. Press the **Adjust / Take** button Turn Right/ Left button on Keypad.
2. If you want to switch the sound off, press the **FUNCTION (Audio mute)** button.
3. You can cancel this function by pressing the **FUNCTION (Audio mute)** or volume control button.

### 3) On Screen Menus Language Selection



- SETUP -> On Screen Display -> OSD Option -> Language
- The menus can be shown on the screen in the selected language.
- Supported Language: English, Spanish, Portuguese, German, French, Italian

## 6. On Screen Menus Selection and Adjustment

### 1) How to adjust the OSD screen

1. Press the **MENU** button and then **UP/DOWN** button to select each menu.
2. Press the **SEL/INPUT** button and then use **UP/DOWN (SEL/INPUT)/MENU** button to display the available menus.

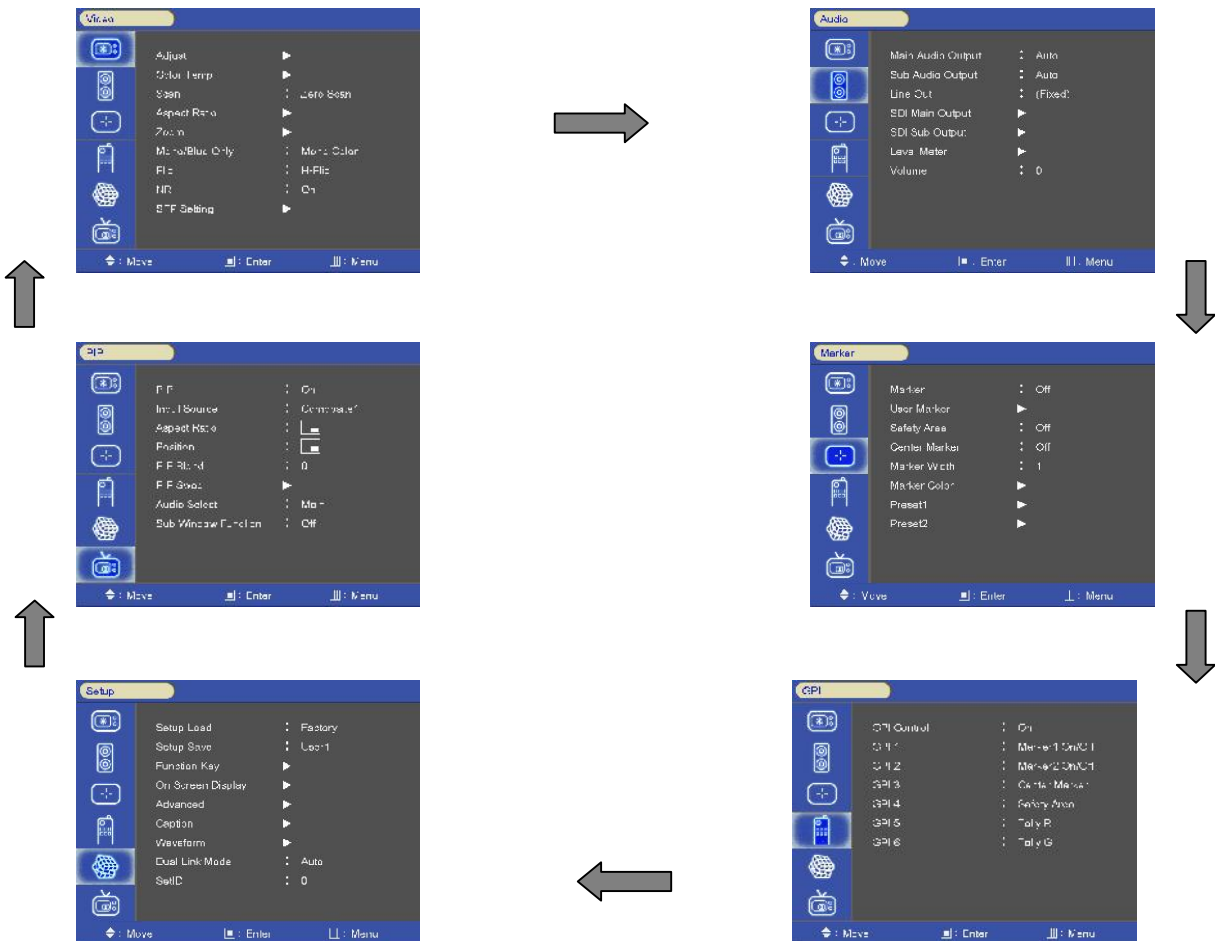

• Your monitor's OSD (On Screen Display) may differ slightly from what is shown in this manual.

## 7. **SELECT VIDEO INPUT**

### 1) **How to Select Video Source by OSD**

1. Press the **SET/INPUT** button and then **UP/DOWN** button to select each video source.
2. Press the **SET/INPUT** button to go to desired video source.
3. If Input Name is enabled, The **SET/INPUT** button goes into input name edit mode instead of selecting source.

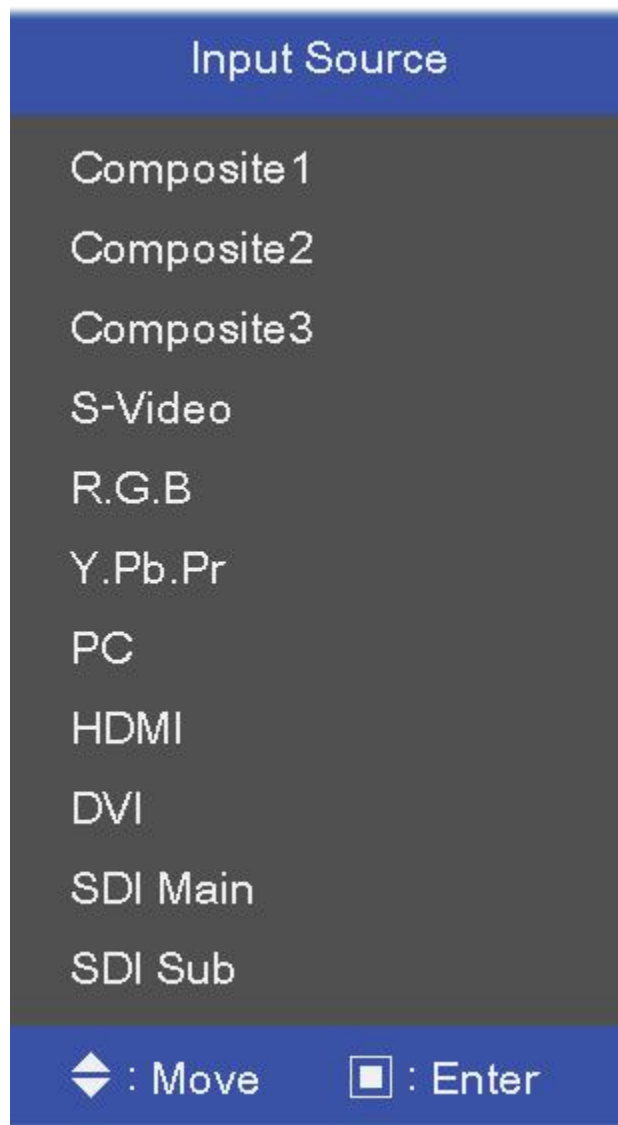



## 8. PICTURE MENU OPTIONS

### 1) Video Menus of each Input modes



< Video (NTSC) Picture menu >



< PC Picture menu >



< SDI, HDMI Picture menu >

### 2) Adjust



- Adjust the values of Brightness, Contrast, Color, Tint and Sharpness directly from -50 to 50
- Contrast, Brightness, Sharpness, Color (All Sources), Tint (without PC, DVI, HDMI, Component), Phase (Component).

### 3) Color Temperature Control

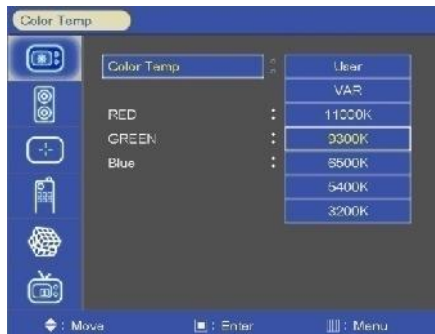

- For Setting the Color temperature or adjusting RGB gain value directly
- User (User setting RGB gain value), VAR(3200K ~ 11000K), Often used value(11000K, 9300K, 6500K, 5400K,3200K)

#### 4) SCAN



1. Over Scan – 95% input size and fit the selected display size
2. Zero Scan – 100% Input size and fit the selected display size
3. Under Scan – 105% Input size and fit the selected display size
3. Pixel to Pixel – Display size is an input size. If input resolution is bigger than panel size, fit the panel size

#### 5) Aspect Ratio



- For setting the aspect ratio.
- Full Screen: The images are displayed with a panel size.
- Full Screen, 16:9, 4:3, 14:9, 13:9, 1.85:1, 2.35:1: The images are displayed with each aspect ratio.
- PC mode: Full Screen & 4:3 only

#### 6) Zoom



- Can see the enlarged picture by (2X, 3X, 4X, 5X) ratios.
- If user select the Zoom 2X, can see the below yellow box in picture.
- Press Select or Enter button, user can see the enlarged picture.
- Menu key escape the zoom mode.

- Example (3X3)



Zoom X position: Coordinate of video image's column position.

Zoom Y position: Coordinate of video image's row position.

7) **Mono/Blue Only**



- Mono color: For selecting monochrome images.
- Blue Only: Images have only blue color expect red and green color

8) **PC Menu (pc mode only)**

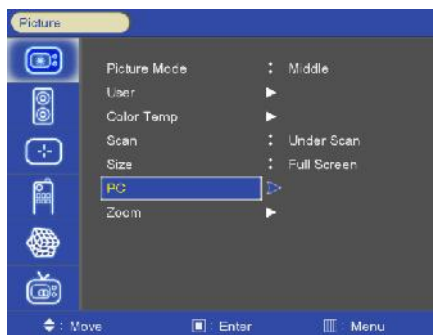

- Only operate PC input mode
- Select Auto-adjust and adjust Phase, HV position, Frequency
- Auto-Adjust automatically set the optimum values of Phase, HV position and Frequency.

9) **Flip**



< H-Flip Off >

< H-Flip On >

-H-Flip Display ON/OFF

10) **NR (Noise Reduction)**

-Noise Reduction on/off. (NR is for Video signal (HD-SDI, Composite, S-Video and Y.Pb.Pr) & DTV timing.

### 11) SFP Setting



-SFP Modules Output CH selected

## 9. SOUND MENU OPTIONS

### 1) MAIN / SUB Audio out



-Main: Select Internal Speaker out. (Auto/SDI1/SDI2/HDMI/Line in)

-Sub: Select sub display sound. (Auto/SDI1/SDI2/HDMI/Line in)

### 2) SDI Main/ SDI Sub Audio Output Channel

- Audio output channel source select. (Channel1~4, Channel1/2, Channel3/4, off)

### 3) SDI Main/ SDI Sub Audio Group

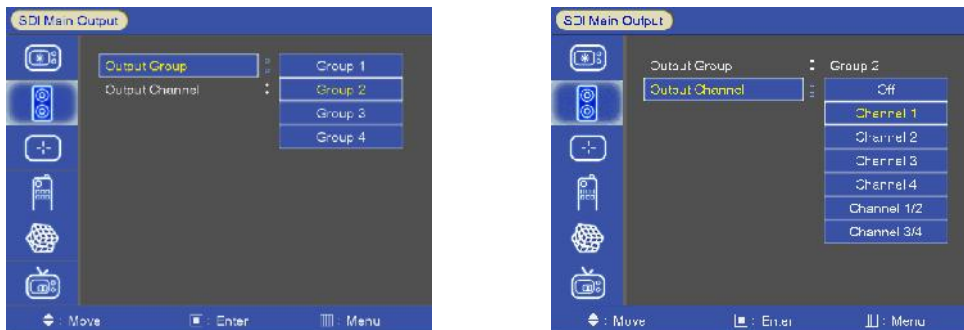

- Select primary or secondary audio group to extract. (Group 1~4)

#### 4) Level Meter



- Display the audio level meter on screen in SDI input.
- Audio level meter cannot display with OSD.

#### 5) Level Meter Type

- Pair: Respectively Channel with right and left display
- Group: Respectively group display

#### 6) Level Meter Position

- Level Meter Position selects. (TOP/Middle/Bottom)

#### 7) Level Meter Scale

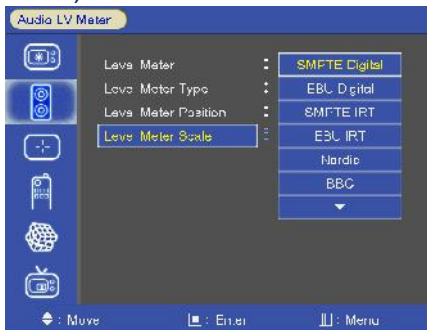

- Level Meter Scale mode selects.  
(SMPTE Digital/EBU Digital/SMPTE IRT/EBU IRT/Nordic/  
BBC/EBU/DIN/Expander DIN/SMPTE VU/EBU VU/France VU)

#### AUDIO SCALES

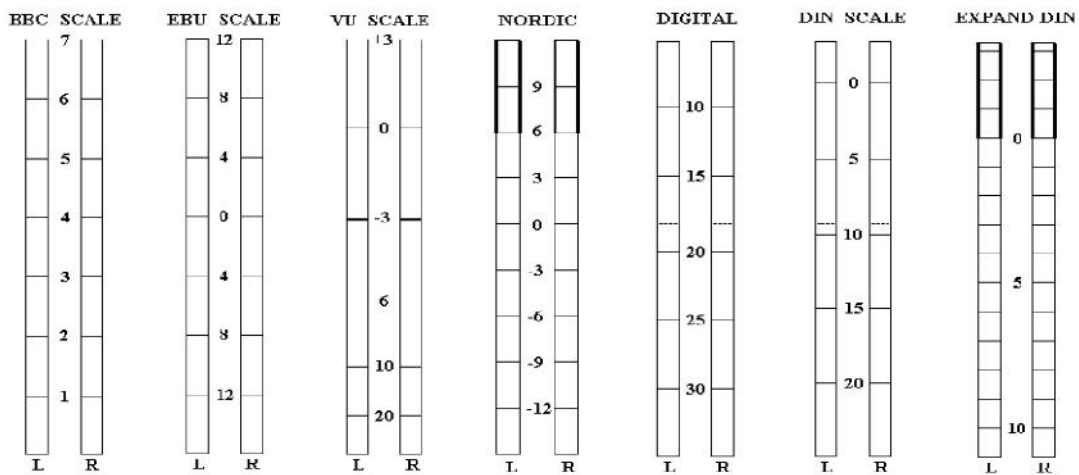



8) **Volume**

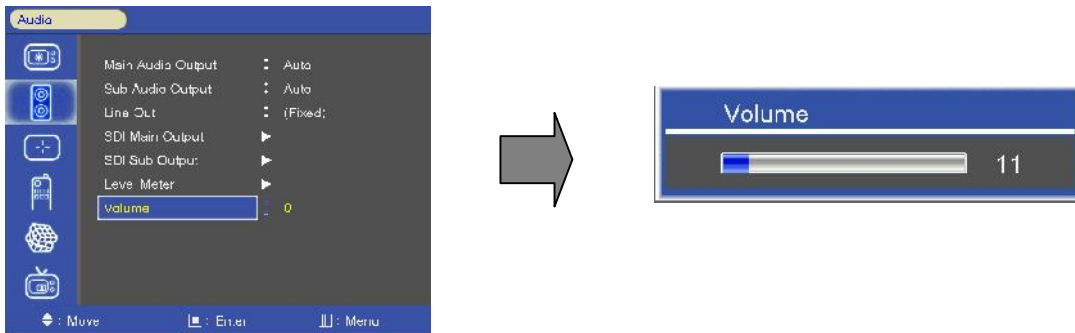

- Adjust the speaker or headphone Volume level. (0~100)

10. **Marker MENU OPTIONS**

1) **Marker & User Marker**



< **Marker** >



< **User Marker** >

1. Marker : 16:9, 4:3, 14:9, 13:9, 1.85:1, 2.35:1, 1.85:1&4:3, User1, User2, User3 fitted panel size marker on screen.

2. User Marker: The user wants Marker size setting. (Below panel size)  
Example (1440x900 panel)



16:9 (16:9 Marker)



16:9 (4:3 Marker)

## 2) Safety Area



-Safety Area: Draw dotted line Marker on screen in case of images.  
(16:9 95/93/90/88/80%, 4:3 95/93/90/88/80%, EBU Action 16:9/14:9/4:3, EBU Graphic 16:9/14:9/4:3)

## 3) Center Maker



- "+" Marker on center of screen

## 4) Marker Width

-Marker line thickness setting. (0~10)

## 5) Marker Color



- Marker Line Color: Select Marker line color (White, Yellow, Blue, RED, Black)
- Safety Line Color: Select Safety line color (White, Yellow, Blue, RED, Black)
- Marker Back Color: Select Marker Back Color. (None, Gray, White, Blue, Black)
- Safety Back Color: Select Safety Back Color. (None, Gray, White, Blue, Black)
- Marker BK Blend Color: Select Marker blending level. (0 ~ 5)
- Safety BK Blend Color: Select Safety blending level. (0 ~ 5)

## 6) Preset1 & Preset2

- For setting the marker to use by GPI controller.
- GPI preset markers are only worked by GPI controller

## 11. GPI MENU OPTIONS

### 1) GPI Control & GPI#

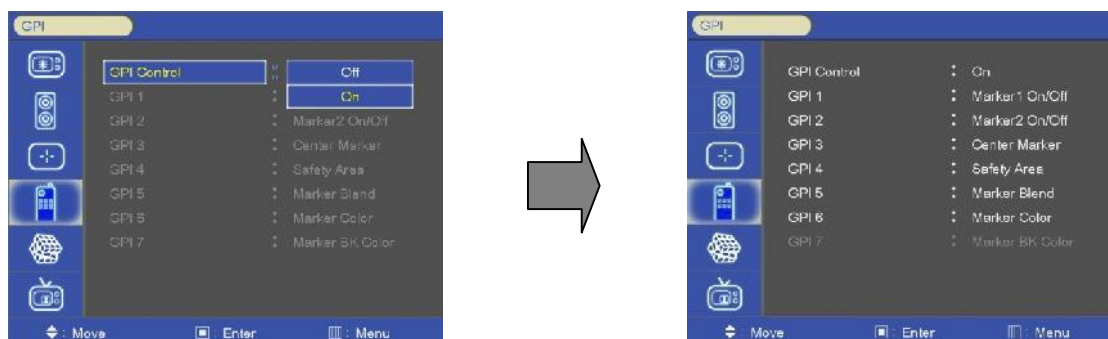

- For allocating functions to particular GPI pins.
- When remote control operations are to be performed using the GPI Controller.
- GPI Control: GPI function Enable/Disable
- GPI 1 ~ 7

GPI Function	Description
UNDEF	Not set (no function allocated)
Marker1 On/Off, Marker2 On/Off	Displays the markers which have been set by the GPI PRESET1, 2 items on the screen.
Center Marker	Displays the center marker.
Safety Area	Displays the Safety Area.
Tally R, Tally G	For lighting up the Red or Green tally lamp.
Scan	Over Scan/Zero Scan/Under Scan/ Pixel to Pixel
Input Composite1, Input G.B.R, Input SDI Main, Input SDI Sub, Input Y.Pb.Pr , Input PC , Input DVI, Input HDMI	Switches the input source.
Menu Key, Enter Key, Up Key, Down Key Left Key, Right Key	Use the key function by GPI.
Function 1, Function 2, Function 3	Activates FUNCTION 1, 2, 3 buttons
Aspect	Sets the aspect ratio of the images
Waveform	Activates WAVRFORM & Vector Scope (SDI Only)
GPI 7 : Power Key(Fixed)	



## 12. **SETUP MENU OPTIONS**

### 1) **Setup Load & Setup Save**



- Setup Load: Load user saved values or default value
- Setup Save: Save user setting values at user 1, 2, 3.

### 2) **Function 1 & Function 2 & Function 3**



- Function 1, 2, 3: Select the function to be allocated to the FUNCTION 1, 2, 3 buttons

Function1&2 button	Description
UNDEF	Not set (no function allocated)
Waveform	Activates WAVRFORM & Vector Scope (SDI Only)
Level meter	Activates Audio Lever Meter
HV Delay	Activates „H & V' blanking display „H DELAY“ -> „V DELAY -> „HV DELAY“ -> OFF
SDI Main/SDI Sub/Analog	Select SDI Main/SDI Sub/Analog source directly
Scan	Executes Scan function ( Over-Scan -> Zero-Scan -> Under Scan-> Pixel to Pixel)
Aspect	Sets the aspect ratio of the images
Mono/Blue Only	Execute Mono color or Blue Only
Audio Channel	Select the extract the embedded audio channel in SDI input.
Marker size	Marker size Select
Safety Area Marker	Safety Area Select

Time Code	Time Code Display
Caption	Closed Caption (Analog Signal only)
Audio mute	Toggles sound status of speaker/headphone in mute.
Still image	Toggles picture status between motion and still image.

### 3) On Screen Display

- **OSD Option**

- Language: Select a language for the menus to appear in. (English, Spanish, Portuguese, German, French, Italian)
- OSD Position: L-T, R-T, C, L-B, R-B
- OSD Transparency: Disable blending OSD background with video image.
- OSD Time out: OSD gone time setting. (3~200)

- **Time code**

- Time code Enable: Time code Display (off/LTC/DVITC, SDI only)
- Time code size: Time code size select. (Small, Middle, Large)
- Time code Position: Time code display position selects (L-T, C-T, R-T, L-B, C-B, R-B)
- Time code Transparency: Disable blending Timecode background with video image. (0%, 25%, 50%, 75%, 100%)

- **Under Monitor Display (color: Tally R/G mode action )**



UMD



Tally Red



Tally Green

- UMD: UMD display on/off
- UMD Character: UMD Character Select
- UMD Position: UMD display position select (L-T, C-T, R-T, L-B, C-B, R-B)
- UMD FG Color: UMD Character color Select (RGB\_255\_192\_128\_Transparent)
- UMD BG Color: UMD BG color Select (RGB\_255\_192\_128\_Transparent)

- **Input ID**



Message OSD



Info Message

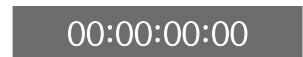

Timecode

- Input ID: source Message display.
- ID Style: select "Input Format"/"Custom Label"
- Input Label: Display user made name instead of input source name on source OSD and message OSD

● **SDI Signal state**

SDI Signal date display on/off (H/V sync, image, Audio, Audio Phase, EDH packet, EDH FF CRC, EDH APCRC, SAC, EAV, VPI)

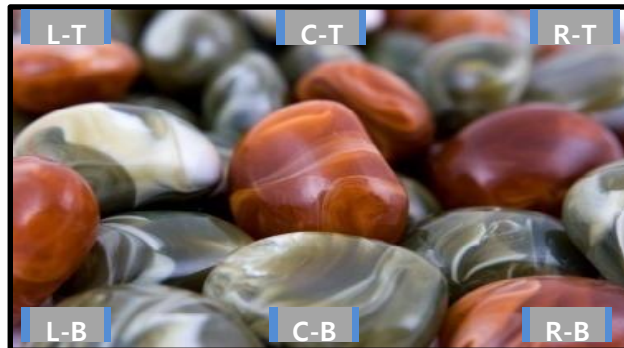

4) **Advanced**



- Information, Control, Screen Saver, Screen Control, Fan Control, x768 Mode

● **Information**



- Version, Release day, Release time, operating time, FPGA Version, Calibration ID

● **Control**



- FRONT LED: Front LED on/off  
 - Local Enable: Power, up and down key is only worked, if Local enable is off.  
 - Remote Enable: Select the controller of local or remote. If remote controller is selected, both local (front key) and remote are worked. However select local, local key only operated.  
 - Auto Key Lock: If it does not work 10 minutes to lock automatically. Key button is operated after being pressed about 2 seconds

● **Screen Saver**



- Blue Screen: Enables screen saver functions to avoid panel burning.
- BG Gray: Select gray level on besides display picture
- Power save Mode: DPMS (Display Power Management Signaling) Power Save Mode

● **Screen Control**

- Reset Calibration
  - Color Calibration Reset
- Backlight Adjust
  - Inverter dimming Level select (0~100)
- Gamma Select
  - Gamma Level Select (0.8 ~ 3.0)
- I/P Mode
  - Line Doubler/inter-Field/Field Merge function on/off
- Dithering
  - Dithering function on/off
- Internal Pattern:
  - 100% Color Bars, 75% Color Bars, Luma, RGB, White, Black, RED, Blue, Green

● **Fan Control**

- Fan Control: Internal Fan Controls driving option by temperature sensor **Auto** / force **on** / force **off**
- Fan Active Temperature: Adjusts fan driving temperature by Celsius degree. It works only when the Fan Control setting is Auto.
- Hysteresis: Adjusts fan driving hysteresis temperature by Celsius degree. (1~10°C)
- Shutdown: For a monitor protection is above of 75 °C , Power Off.
- MCU Fan Control: Control main MCU Fan On/Off

● **Network Config**

-Plura System Controller (PSC-400) Network setting.

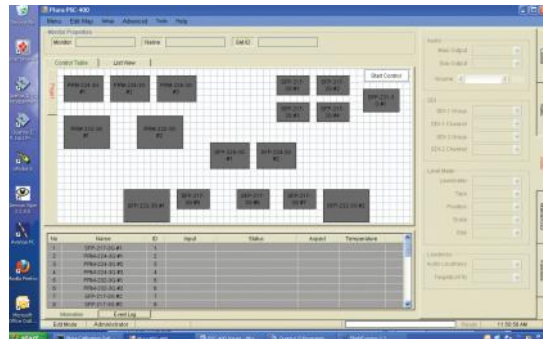
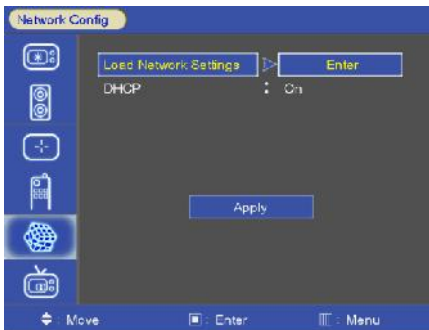

→Load Network Settings: ETHERNET cable connected after "Enter". (IP Address/Gateway/Subnet Load)

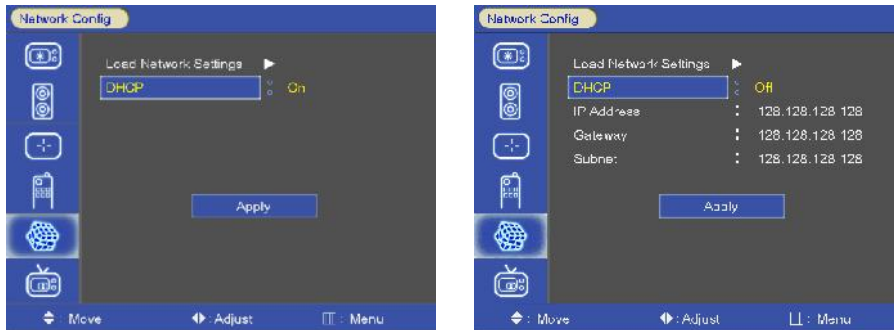

→DHCP: DHCP on/off (Manual IP settings – DHCP on)  
 \* "Apply" enter all settings after.

● **X768 Mode**

-Selects X768 native PC video timings. (Auto/1024x/1280x/1360x/1366x)

5) **Caption**

→Closed Caption: 608 Line21, 608 ANC, 608 Trans-coded mode Select



- 608 Caption mode Select. (C/C1, C/C2, C/C3, C/C4, TEXT1, TEXT2, TEXT3, TEXT4, OFF)

6) **Waveform Format (SDI ONLY)**

Press the **WAVEFORM** button to display the WAVEFORM Mode

- **Y-Pb-Pr Waveform**



- Y\_Pb\_Pr WAVEFORM & Audio Level Meter & Info Window & Time code Display.

- **Y-Waveform + Vector Scope**



- WAVEFORM & Vector Scope & Audio Level Meter & Info Window & Time code Display.



- **Double**



- SDI 1, 2 & WAVEFORM & Vector Scope & Audio Level Meter & Info Window & Time code Display.

- **Y-Waveform + Vector Scope Trans**



- WAVEFORM & Vector Scope Trans.

- **Vector Color**

- Vector color: Select 100% or 75%

- **Line Select**

- Select line WAVEFORM & Vector Scope display.

- Line select: 1~540

- **Line #**

-line select

● **Line Display**

-off/on/5 sec

7) **Dual Link Mode (SDI only)**

-Dual Link Mode select. (Auto/Off/RGB444/YCbCr444/YCbCr422/Progressive)

8) **Set ID & Active Set ID**

- If control each Board, must set ID numbers of each Board (01~99).

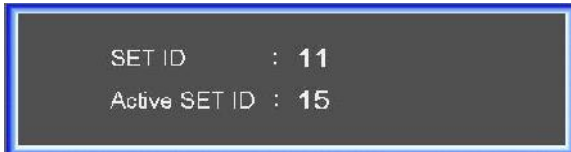

- Set Active SET ID number Before Control each Board by Remote control.  
- If control only 15<sup>th</sup> Board, Active SET ID must set 15.

### 13. **PIP (Picture In Picture)**

- Watch two programs or source at the same time. And set up PIP size and position.  
- Only Dual Link model Select

1) **PIP ON/OFF**



- Control PIP function On/Off.

2) **Input Source**

- PIP input Source can operate with different signal and type.  
- Analog (Composite1, 2, 3, Y.Pb.Pr, GBR, PC) inputs + Digital (DVI, HDMI) + SDI (SDI1, SDI2) inputs  
-SDI + SDI input PIP

Ex) AV + S-Video (X), DVI + SDI (O), PC + DVI (O), SDI1+SDI2 (O)

3) **Aspect Ratio**





- Choose PIP size of Small/POP1/POP2



PIP Small



PIP1



POP2

**4) Position**

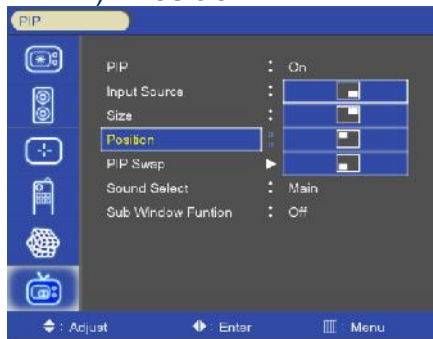

- Choose the pip position on the each corner of the pane

**5) PIP Blend**



-Blend to PIP size of Small

**6) PIP Swap**

- Using Swap option, you can exchange two programs or source at the same time.

**7) Sound Select**

- Using Sound Swap option, you can exchange the sound of two programs or source at the same time.

**8) Sub Window Function**



- Full Sub Window: Display the same full images on POP1 screen.
- Part Sub Window: First image scale 4:3 aspect ratio and then display on POP2 screen.
- FULL, Part function is only used in Digital input (SDI1, SDI2, DVI, HDMI)



Sub Window Full



Sub Window Part

14. **OSD TREE**

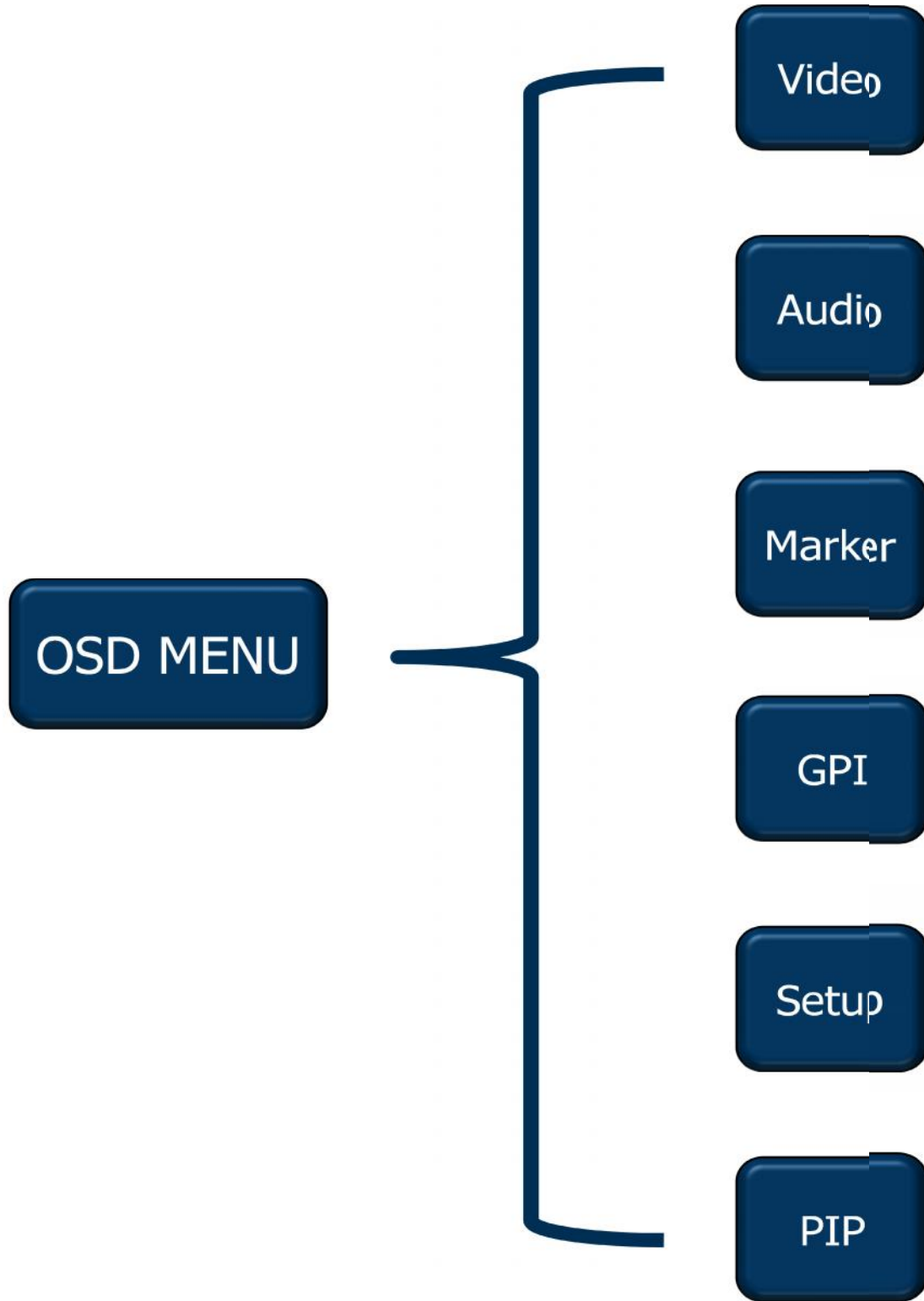

1) *Picture*

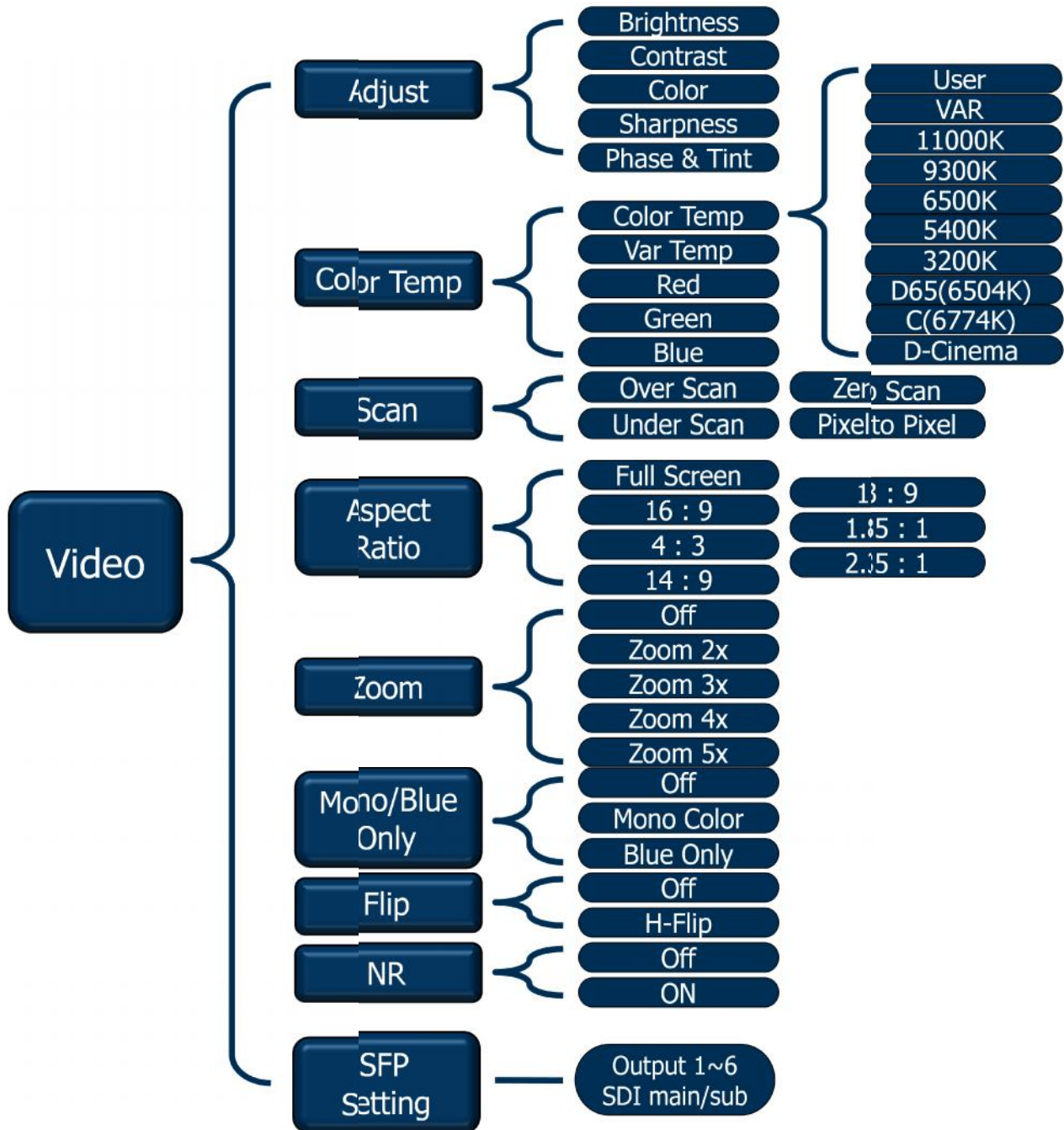

2) Sound

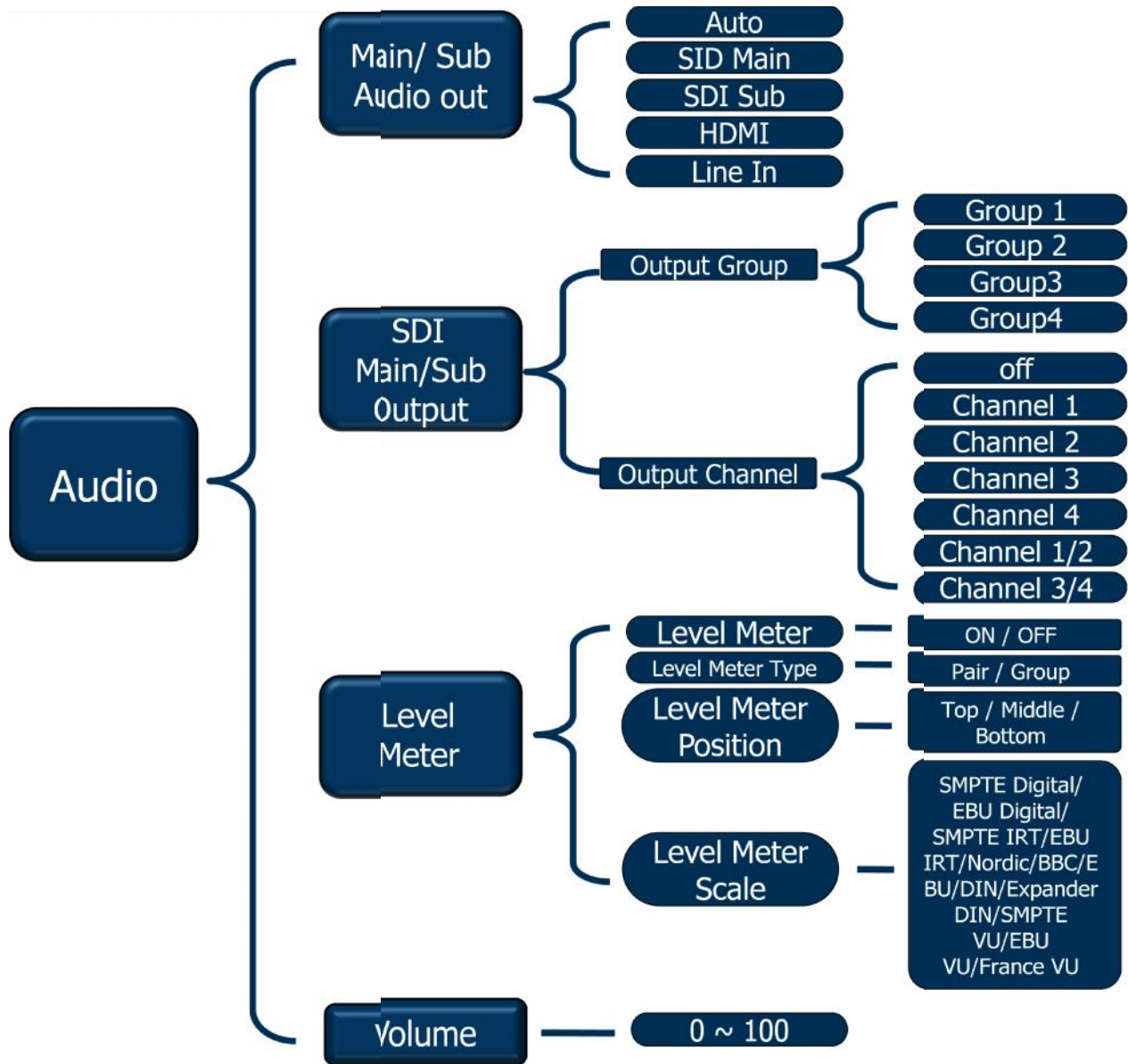



3) Marker

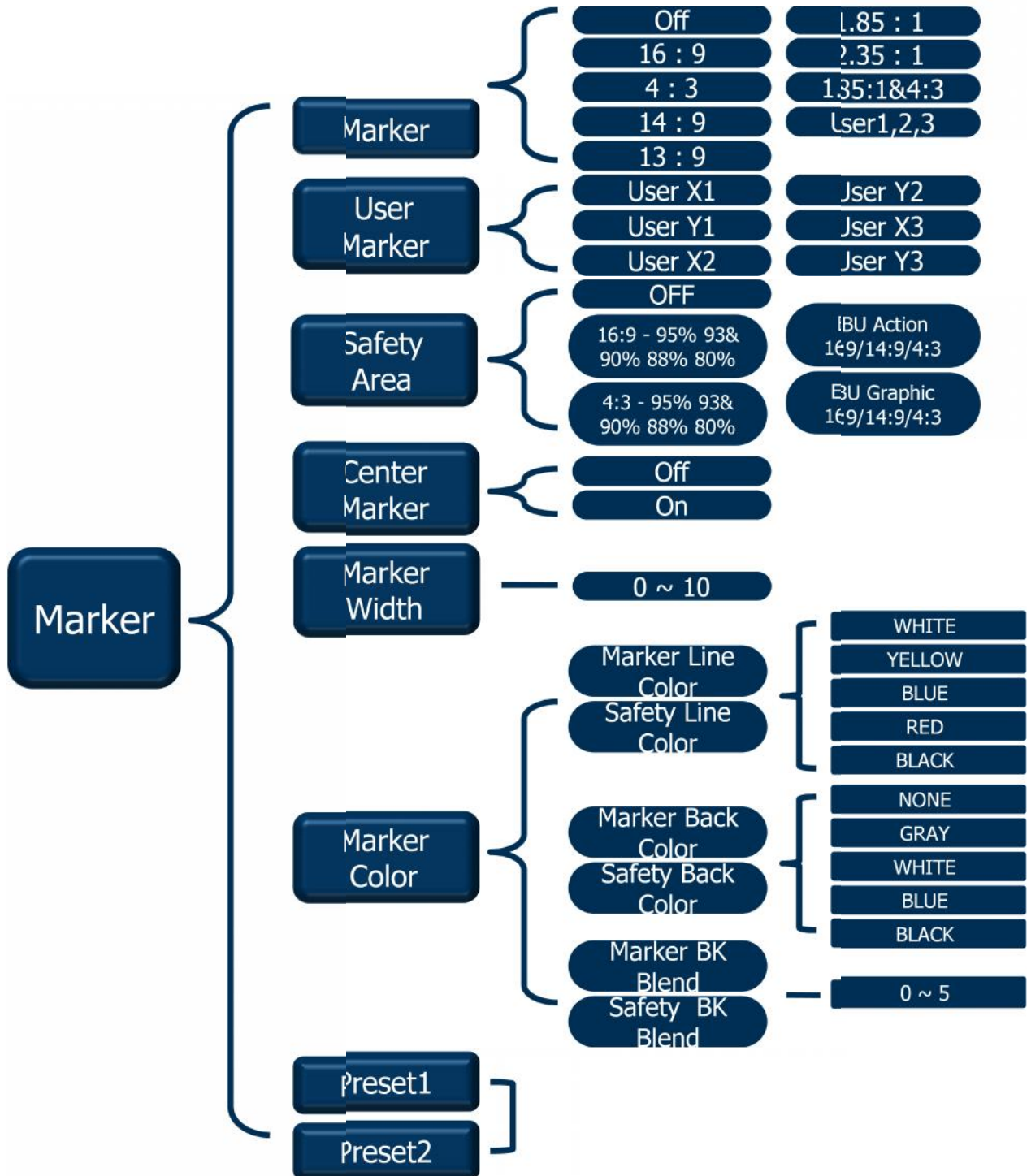

4) GPI

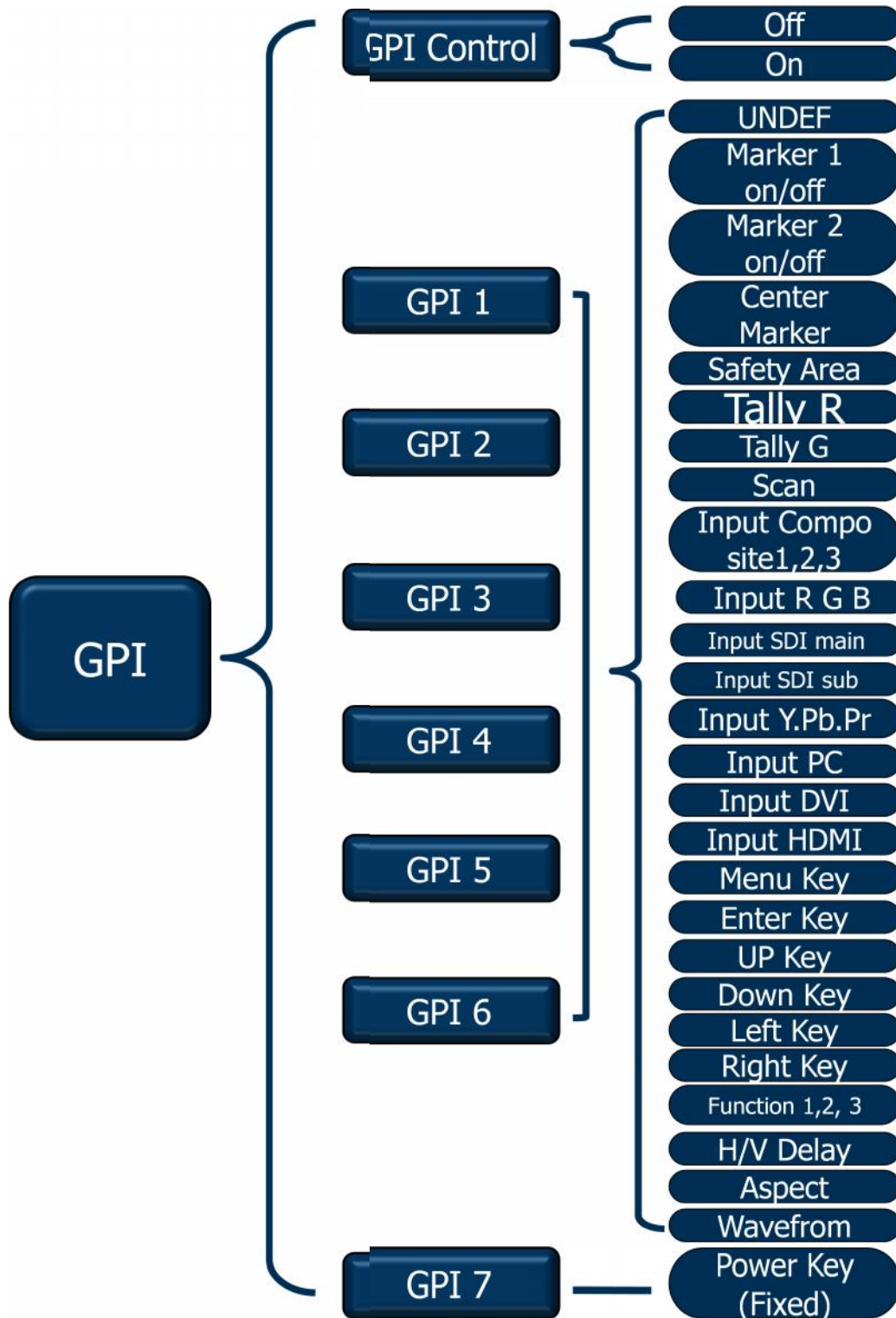

5) Setup

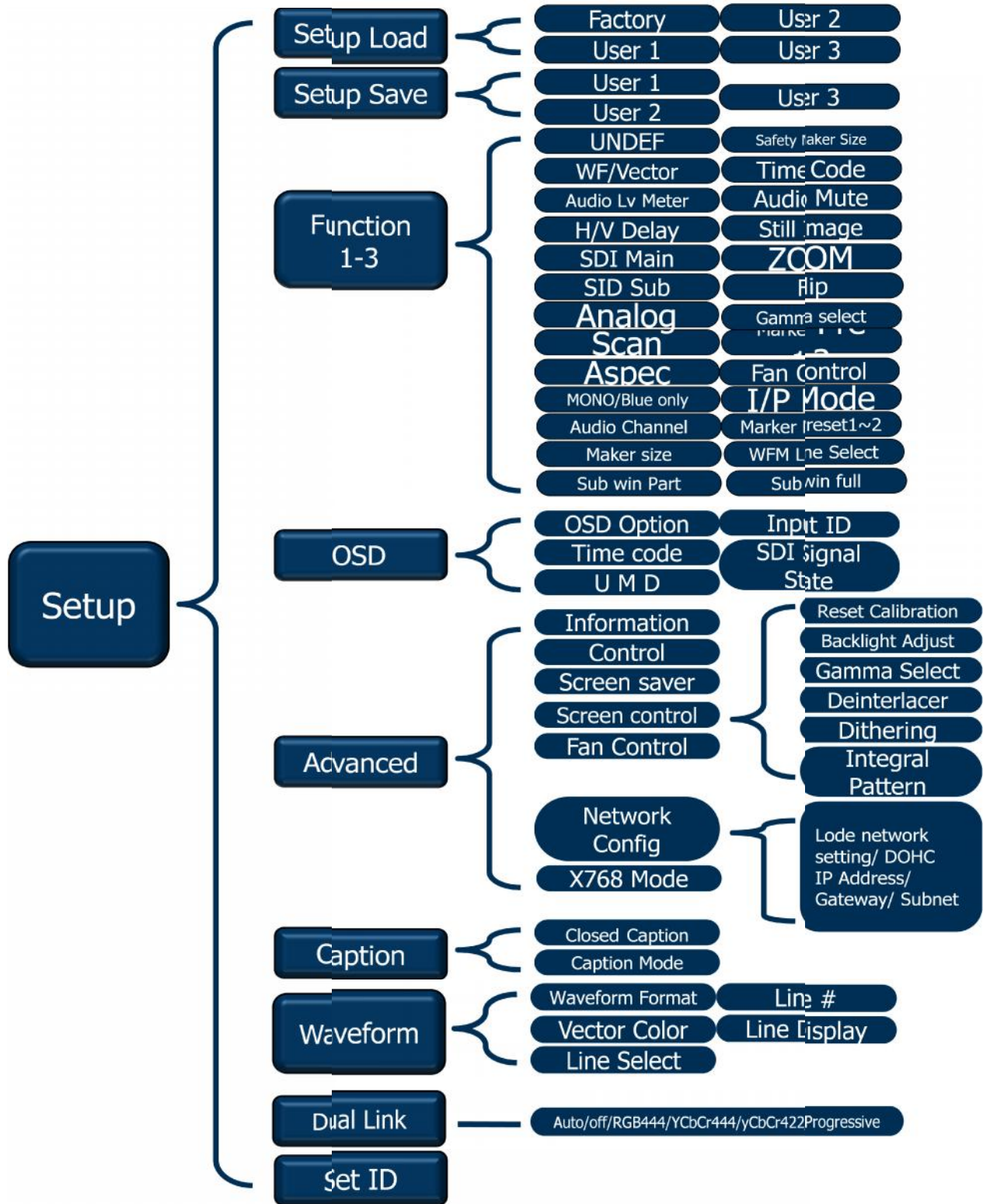



6) PIP

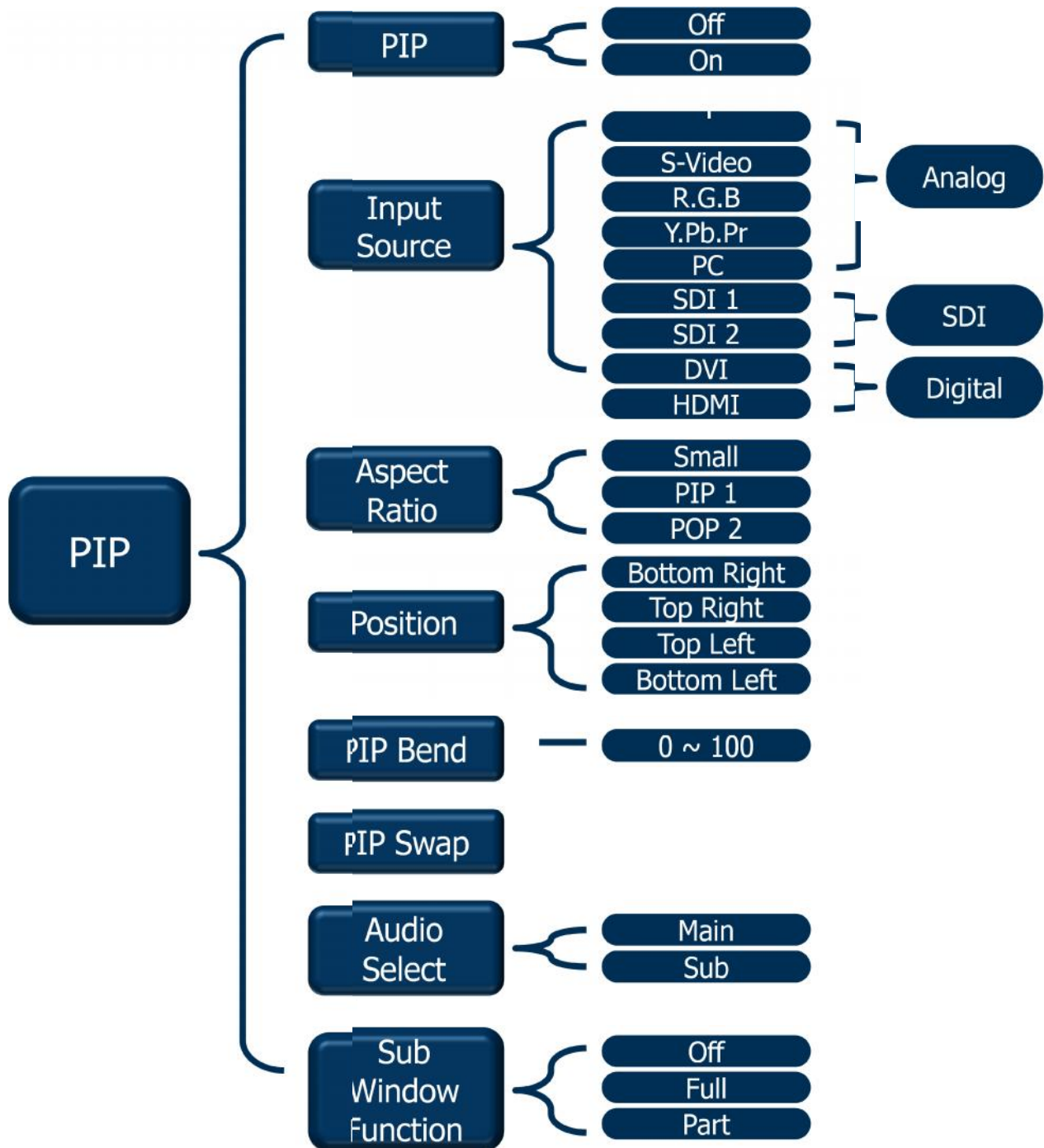

## 15. **SUPPORTED INPUT MODES**

### 1) **Supported Signals**

Items		Specifications
SFP-217-3G Display	Panel	17.3" FHD TFT LCD
	Resolution	1920 horizontal. by 1080 vertical.(Contrast 500:1)
	Brightness	200 cd/m2
	Viewing Angle	R/L 40/40(Min), U/D 30/10 (Min)
Supported Signals	Serial Digital Interface	HD SDI- 2.970Gbps
		SD HDI- 270Mbps
	HDMI DVI-I (DVI+VGA_IN)	H Frequency Range : 20~82 kHz
		V Frequency Range : 55 ~ 90 Hz
		Maximum resolution :1920x1080 60Hz
		Maximum pixel rate : 162 MHz
		DTV mode support : 720P, 1080i, 1080p
	ANALOG RGB	H Frequency Range : 20~82 kHz
		V Frequency Range : 55 ~ 90 Hz
		Maximum resolution : 1920x1080 60Hz
		Maximum pixel rate : 162 MHz
		DTV mode support: 720P/1080i/1080p
		SOG sync support
	ANALOG Component (DTV/DVD)	1080p/1080i/720P/480i/576i/480P/576P
	CVBS	NTSC/PAL/SECAM

### 2) **Supported Timings**

#### ● **SDI input**

SDI input		
SDI input Signal formats	SMPTE-428.1M	2048x1080P(24/25)
	SMPTE-425M(3G)	1920x1080P(50/60)
	SMPTE-260M	1920x1035i(60/59.94)
	SMPTE-259M	1920x1080i(50)

	SMPTE-274M	1920x1080i (50/59.94/60)
		1920x1080P (30Psf/25Psf/24Psf/30/25/24)
	SMPTE-296M	1280x720P (24/25/30/50/59.94/60)
	SMPTE-125M	480i(59.94)
	ITU-R BT.601	576i(50)

● **PC & DVI input**

Section	Resolution	H Frequency ( kHz )	V Frequency ( Hz )	Pixel Frequency ( MHz )	Comment
PC	640x400	37.861	85.08	31.5	
	640x350	31.469	70.087	25.175	
	640x350	37.861	85.08	31.5	
	640x480	31.469	59.94	25.175	
	640x480	35.000	66.667	30.24	
	640x480	34.940	69.884	28.513	
	640x480	37.861	72.809	29.765	
	640x480	37.500	75.0	31.5	
	640x480	43.269	85.008	36.0	
	640x480	45.540	90.0	37.889	
	720x400	31.469	70.087	28.322	
	720x400	37.927	85.039	35.5	
	800x600	35.156	56.25	36.0	
	800x600	37.879	60.317	40.0	
	800x600	43.764	70.02	45.513	
	800x600	48.077	72.188	50.0	
	800x600	46.875	75.0	49.5	
	800x600	53.674	85.061	56.25	
	800x600	56.880	90.0	60.065	
	832x624	49.726	74.551	57.284	
	1024x768	48.780	60.001	64.11	
	1024x768	48.363	60.004	65.0	
	1024x768	56.476	70.069	75.0	
	1024x768	57.703	72.039	78.476	

	1024x768	60.241	74.927	81.724		
	1024x768	60.030	75.029	78.75		
	1024x768	68.677	84.997	94.5		
	1024x768	72.810	90.0	100.187		
	1152x864	53.700	60.0	81.624		
	1152x864	62.932	69.924	96.663		
	1152x864	67.500	75.0	104.993		
	1152x870	68.681	75.062	100.0		
	1152x900	61.846	66.0	94.787		
	1152x900	72.713	76.047	105.561		
	1280x720	47.760	60.0	74.481		
	1280x720	52.500	70.0	89.040		
	1280x720	54.072	72.0	91.706		
	1280x720	56.400	75.0	95.654		
	1280x768	60.150	75.0	102.977		
	1280x960	60.000	60.0	102.104		
	1280x960	59.640	60.0	102.104		
	1280x1024	63.337	59.978	108.18		
	1280x1024	63.981	60.02	108.0		
	1280x1024	64.754	60.06	108.992		
	1280x1024	63.600	60.0	108.883		
	1360x768	47.700	60.0	84.700		
	1600x1200	75.000	60.0	162.000		
	DTV	720x480	15.735	59.94	13.500	Interlaced
		720x576	15.735	50.0	13.595	Interlaced
720x480		31.469	59.94	25.175		
720x576		31.250	50.0	26.566		
1280x720		44.964	59.94	74.176		
1280x720		37.500	50.0	60.466		
1920x1080		33.750	60.0	74.25	Interlaced	
1920x1080		28.125	50.0	70.723	Interlaced	
1920x1080		31.250	50.0	72.000	Interlaced	
1920x1080	67.5	60	148.5	Progressive		

**3) SFP Modules Supported**

Plura Part under	Order parts under	Type	Input ch	Output ch
SFP-3G-TXRX-HD-BNCF-LR	EB30HDRT-LN-PLU001	BNC	1	1
SFP-3G-TXRX-HD-BNCF-LR-ReCLK	EB30HDRT-LNR-PLU002	BNC	1	1
SFP-3G-2RX-1310F-LC-MH	EB60LC2R-MN-PLU003	Optical	2	0
SFP-3G-2TX-1310F-LC-MH	EB60LC2T-MN-PLU004	Optical	0	2
SFP-3G-TXRX-1310F-LC-MH	EB60LCRT-MN-PLU005	Optical	1	1
SFP-3G-TX-HDMIF-TypeD	EB34TD1T-SN-PLU007	HDMI	0	1
SFP-3G-2RX-1310F-LC-HD-BNCF-LR	EB90HD2R-MNE-P-PLU008	BNC	2	0

**4) Mechanical Dimension**

● **SFP-217-3G**

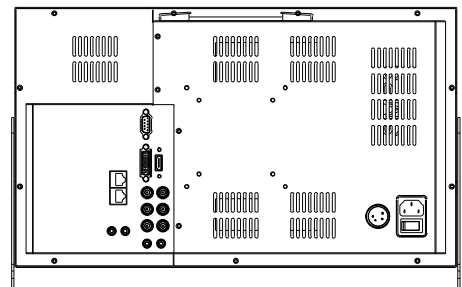
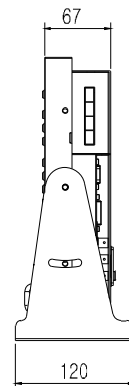
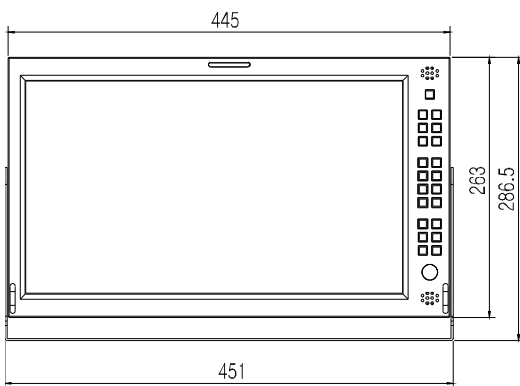
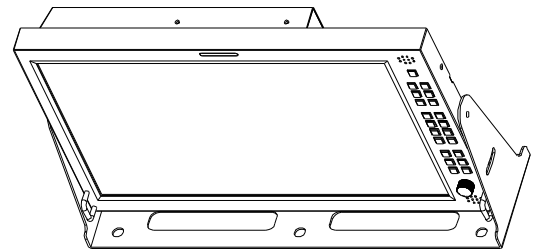
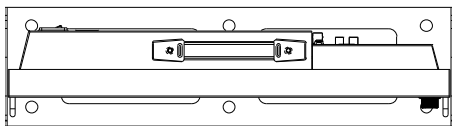

● SFP-221-3G

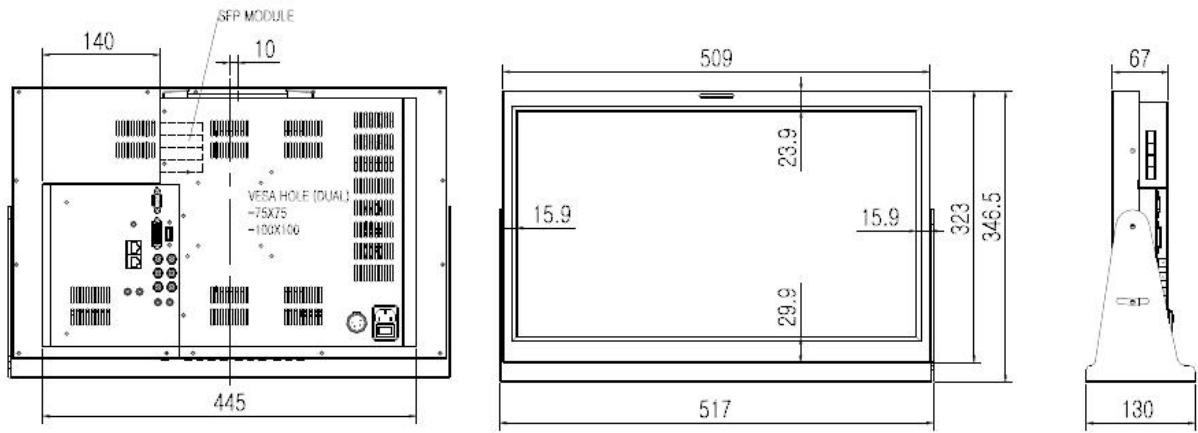

● SFP-224-3G

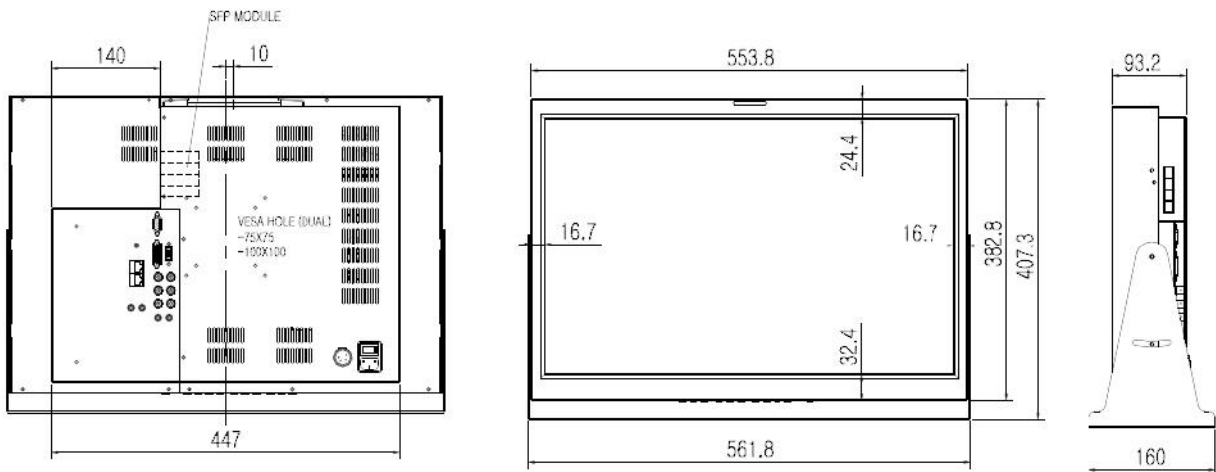

● SFP-232-3G

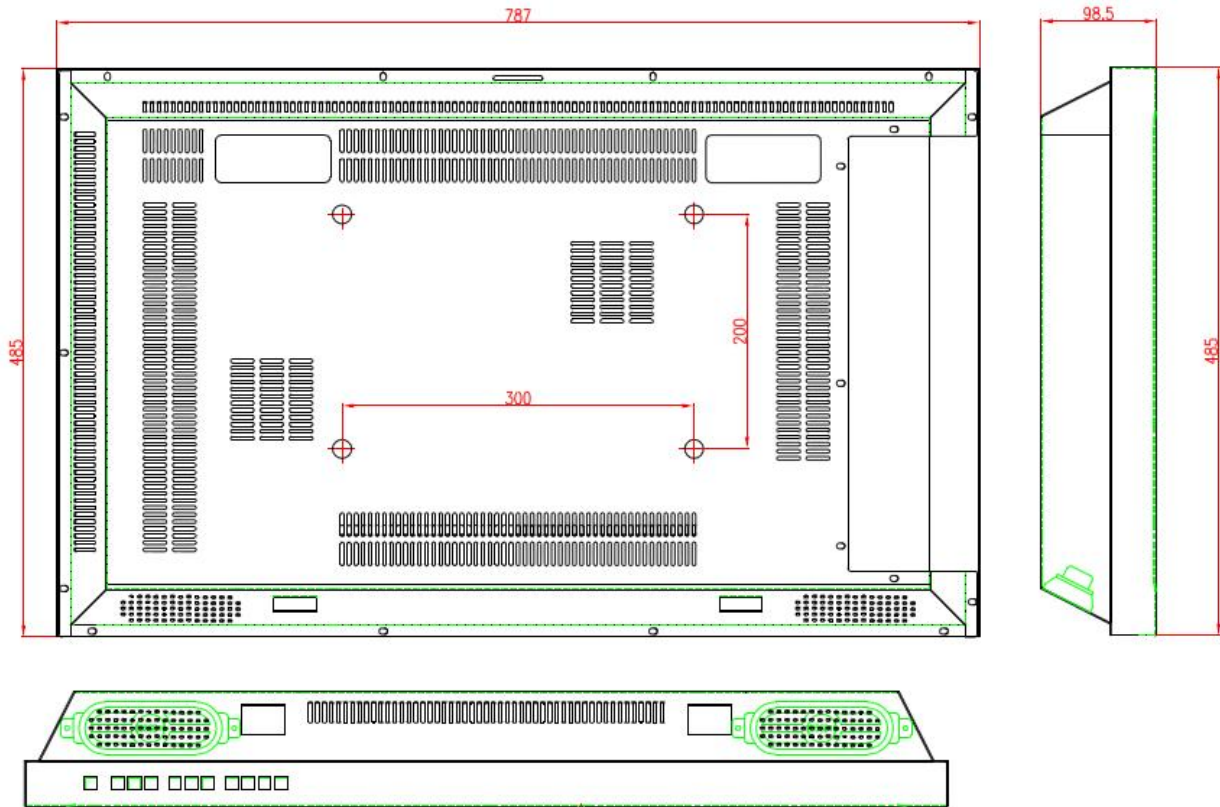

# plura<sup>®</sup>

[www.plurasfp.com](http://www.plurasfp.com)

**Plura Broadcast, Inc. - West Coast**

1930 W. Quail Ave  
Phoenix, AZ 85027  
Tel: (602) 944-1044  
Fax: (602) 324-9688

**Plura Broadcast, Inc. - East Coast**

67 Grand avenue  
Massapequa, NY 1175  
Tel: (516) 997-5675  
Fax: (516) 593-7900