

KS Series



User Manual

KS212C – 3600 watt Active Cardioid Subwoofer

KS112 – 2000 watt Active Subwoofer

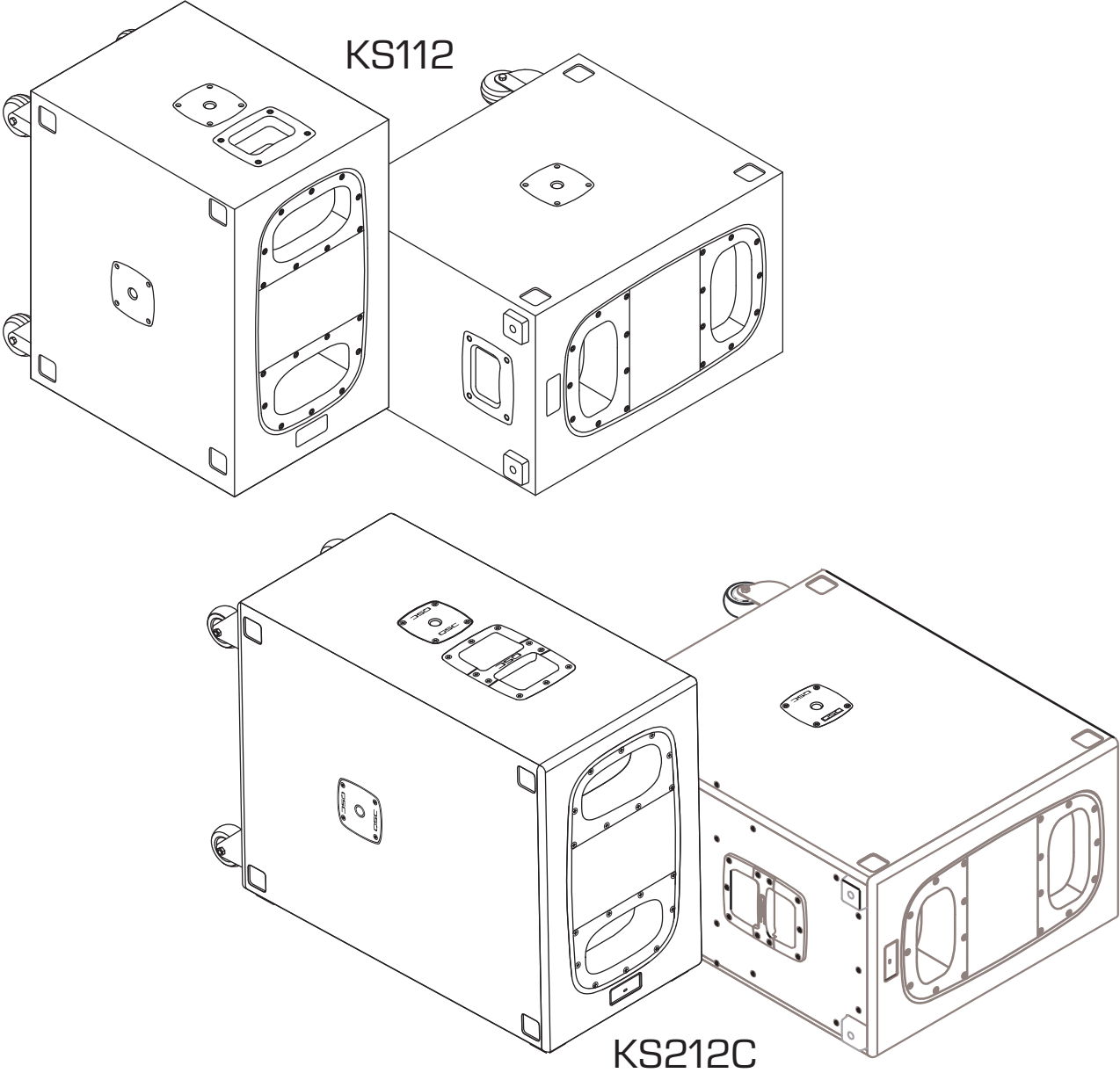

TD-001536-01-A



EXPLANATION OF SYMBOLS

The term “WARNING!” indicates instructions regarding personal safety. If the instructions are not followed the result may be bodily injury or death.

The term “CAUTION!” indicates instructions regarding possible damage to physical equipment. If these instructions are not followed, it may result in damage to the equipment that may not be covered under the warranty.

The term “IMPORTANT!” indicates instructions or information that are vital to the successful completion of the procedure.

The term “NOTE” is used to indicate additional useful information.



NOTE: The intent of the lightning flash with arrowhead symbol in a triangle is to alert the user to the presence of un-insulated “dangerous” voltage within the product’s enclosure that may be of sufficient magnitude to constitute a risk of electric shock to humans.



NOTE: The intent of the exclamation point within an equilateral triangle is to alert the user to the presence of important safety, and operating and maintenance instructions in this manual.



IMPORTANT SAFETY INSTRUCTIONS



WARNING!: TO PREVENT FIRE OR ELECTRIC SHOCK, DO NOT EXPOSE THIS EQUIPMENT TO RAIN OR MOISTURE. DO NOT USE THIS APPARATUS NEAR WATER.

1. Read these instructions.
2. Keep these instructions.
3. Heed all warnings.
4. Follow all instructions.
5. Do not use this apparatus near water.
6. Clean only with a dry cloth.
7. Do not block any ventilation opening. Install in accordance with the manufacturer’s instructions.
8. Do not install near any heat sources such as radiators, heat registers, stoves, or other apparatus (including amplifiers) that produce heat.
9. Do not defeat the safety purpose of the polarized or grounding-type plug. A polarized plug has two blades with one wider than the other. A grounding type plug has two blades and a third grounding prong. The wide blade or the third prong are provided for your safety. If the provided plug does not fit into your outlet, consult an electrician for replacement of the obsolete outlet.
10. Protect the power cord from being walked on or pinched particularly at plugs, convenience receptacles, and the point where they exit from the apparatus.
11. Only use attachments/accessories specified by the manufacturer.
12. Unplug this apparatus during lightning storms or when unused for long periods of time.
13. Refer all servicing to qualified service personnel. Servicing is required when the apparatus has been damaged in any way, such as power-supply cord or plug is damaged, liquid has been spilled or objects have fallen into the apparatus, the apparatus has been exposed to rain or moisture, does not operate normally, or has been dropped.
14. The appliance coupler, or the AC Mains plug, is the AC mains disconnect device and shall remain readily operable after installation.

15. Adhere to all applicable, local codes.
16. To prevent electrical shock, the power cord shall be connected to a mains socket outlet with a protective earthing connection.
17. Consult a licensed, professional engineer when any doubt or questions arise regarding a physical equipment installation.
18. Do not use any aerosol spray, cleaner, disinfectant or fumigant on, near or into the apparatus. Clean only with a dry cloth.
19. Do not unplug the unit by pulling on the cord, use the plug.
20. Do not submerge the apparatus in water or liquids.
21. Keep ventilation opening free of dust or other matter.

Maintenance and Repair



WARNING! Advanced technology, e.g., the use of modern materials and powerful electronics, requires specially adapted maintenance and repair methods. To avoid a danger of subsequent damage to the apparatus, injuries to persons and/or the creation of additional safety hazards, all maintenance or repair work on the apparatus should be performed only by a QSC authorized service station or an authorized QSC International Distributor. QSC is not responsible for any injury, harm or related damages arising from any failure of the customer, owner or user of the apparatus to facilitate those repairs.

Life Cycle: 10 years, **Storage Temperature range:** -20° C to +70° C, **Relative Humidity range:** 5 - 85% RH

FCC Statement



NOTE: This equipment has been tested and found to comply with the limits for a Class B digital device, pursuant to Part 15 of the FCC Rules.

These limits are designed to provide reasonable protection against harmful interference in a residential installation. This equipment generates, uses and can radiate radio frequency energy and, if not installed and used in accordance with the instructions, may cause harmful interference to radio communications. However, there is no guarantee that interference will not occur in a particular installation. If this equipment does cause harmful interference to radio or television reception, which can be determined by turning the equipment off and on, the user is encouraged to try to correct the interference by one or more of the following measures:

- Reorient or relocate the receiving antenna.
- Increase the separation between the equipment and receiver.
- Connect the equipment into an outlet on a circuit different from that to which the receiver is connected.
- Consult the dealer or an experienced radio/TV technician for help.

RoHS Statements

These products are in compliance with European Directive 2011/65/EU – Restriction of Hazardous Substances (RoHS).

These products are in compliance with “China RoHS” directives per GB/T26572. The following table is provided for product use in China and its territories:







The KS212C and KS112 这些产品						
部件名称 (Part Name)	有害物质 (Hazardous Substances)					
	铅 (Pb)	汞 (Hg)	镉 (Cd)	六价铬 (Cr(vi))	多溴联苯 (PBB)	多溴二苯醚 (PBDE)
电路板组件 (PCB Assemblies)	X	O	O	O	O	O
机壳装配件 (Chassis Assemblies)	X	O	O	O	O	O

本表格依据 SJ/T 11364 的规定编制。(This table is prepared following the requirement of SJ/T 11364.)
 O: 表示该有害物质在该部件所有均质材料中的含量均在 GB/T 26572 规定的限量要求以下。
 O: Indicates that the concentration of the substance in all homogeneous materials of the part is below the relevant threshold specified in GB/T 26572.
 X: 表示该有害物质至少在该部件的某一均质材料中的含量超出 GB/T 26572 规定的限量要求。
 X: Indicates that the concentration of the substance in at least one of all homogeneous materials of the part is above the relevant threshold specified in GB/T 26572.
 (目前由于技术或经济的原因暂时无法实现替代或减量化) (Replacement and reduction of content cannot be achieved currently because of the technical or economic reason.)

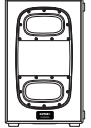
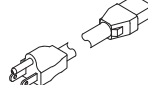
Warranty

For a copy of the QSC Limited Warranty, visit the QSC website at www.qsc.com

Package Contents

 KS212C or KS112 Subwoofer	1	 Locking AC Power cord	1	 QSC White QSC Logo	2
 QSC Limited Warranty TD-000453	1	 Quick Start Guide TD-000499 – KS212C or TD-001518 – KS112	1	 Powered Loudspeaker Safety Sheet TD-000337	1
 35 mm, M20, 915 mm (36 in) long Loudspeaker Pole Included with the KS212C only.	1				

KS212C / KS112 Features

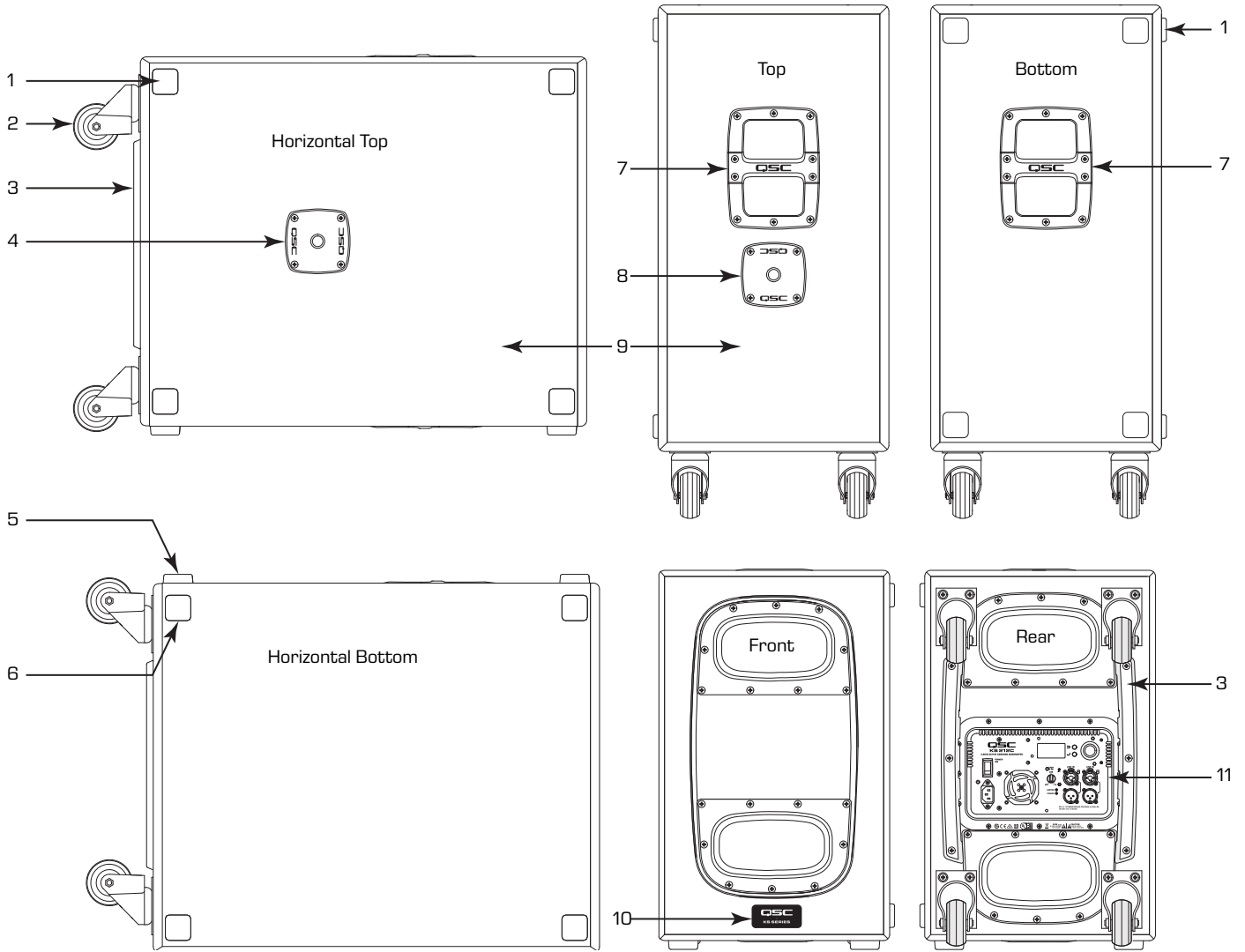

— Figure 1 —

- | | |
|---|--|
| <ul style="list-style-type: none"> 1. Rubber-feet stacking-alignment cups 2. Four low-noise, heavy-duty casters 3. Amplifier protection rails – protects the amplifier when the unit is rolled off, for example, a curb. 4. M20 threaded socket for 35 mm speaker pole 5. Slip-resistant feet - four on the bottom, 6. Slip-resistant feet - four on the side | <ul style="list-style-type: none"> 7. Cast aluminum handles 8. M20 threaded socket for 35 mm speaker pole 9. 18 mm birch plywood for KS212C
15 mm birch plywood for KS112 10. Front power LED 11. Amplifier power module and controls |
|---|--|

About the KS212C Cardioid Subwoofer

The term Cardioid refers to the heart-shaped coverage pattern of an audio device. A cardioid microphone is designed to be most sensitive at the front (on-axis), and least sensitive at the rear (180 degrees off-axis). A Cardioid Subwoofer operates exactly the same way, and is loudest at the front and quietest at the rear.

Subwoofer Energy Dispersion

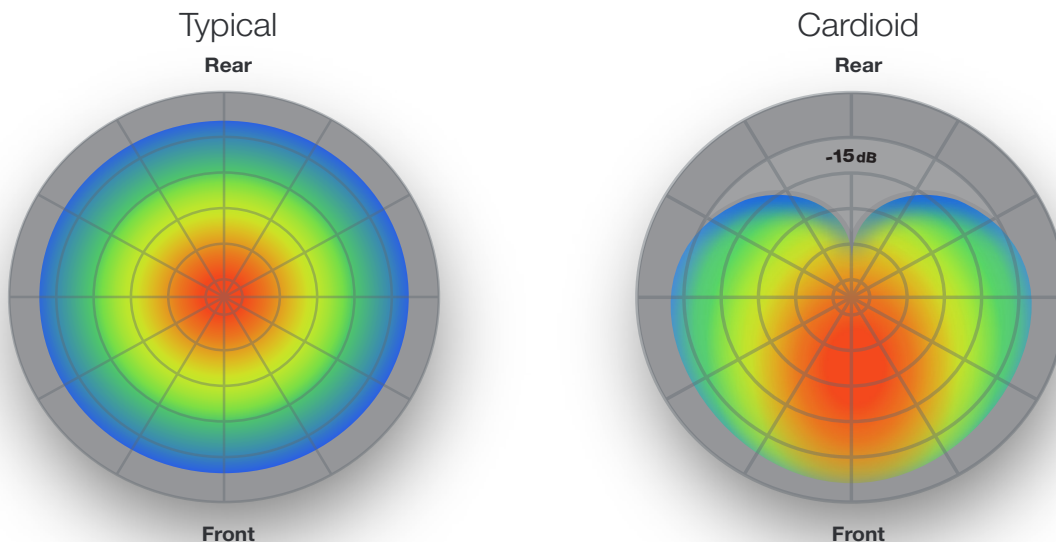

— Figure 2 —

Low frequency energy, from subwoofers, is effectively omnidirectional in nature (equally loud in all directions). This is because low frequency wavelengths are much longer than the dimensions of the subwoofer enclosure, and therefore “wrap” around it. A cardioid subwoofer arrangement employs both front- and rear-firing woofers, and through some clever use of spacing, delay, and polarity, a cancellation of rear-firing energy is created behind the subwoofer, while also enhancing the forward-firing energy.

The KS212C is powered by a Dual 1800 W Class D amplifier, processed with QSC’s latest DSP technology, and incorporates dual, 12-inch, long-excursion drivers that are each arranged in a sixth-order bandpass chamber. Through complex processing, these mirrored components interact at the rear of the enclosure to produce a desirable cancellation, while simultaneously interacting at the front of the enclosure to produce equally desirable summation. This results in a net 15 dB higher output at the front of the cabinet than at the rear. To put this into perspective, 15 dB is the difference between 30 watts and 1000 watts.

KS212C Applications and Installation



WARNING!: Before placing, installing or mounting any speaker product, inspect all hardware, cabinets, transducers, brackets and associated equipment for damage. Any missing, corroded, deformed, or non-load rated component could significantly reduce the strength of the installation or placement. Any such condition severely reduces the safety of the installation and should be immediately corrected. Use only hardware which is rated for the loading conditions of the installation and any possible short-term, unexpected overloading.

Never exceed the rating of the hardware or equipment.

Consult a licensed, professional engineer regarding physical equipment installation. Ensure that all local, state and national regulations regarding the safety and operation of loudspeakers and related equipment are understood and adhered to.



IMPORTANT!: In order to maintain the acoustic properties of the KS212C subwoofer, do not place the unit closer than 50 mm (20 in) from a wall or other object that would reflect sound waves.

Placement of the KS212C

Make sure that the KS212C sub is placed no closer than 20 in (50 cm) to the back wall of the stage.

Side-by-side KS212C subs should be at least 20 inches (50 cm) away from each other.

Stacking the KS212C

You can stack KS212C subwoofers in a horizontal orientation by matching the four rubber feet on the bottom of the top unit to the four cups on the top of the bottom unit. Figure 4 provides a picture worth a thousand words. QSC recommends that you stack no more than two KS212C in order to maintain the cardioid pattern. Stacking more boxes will result in less rejection from the rear.

- One single sub offers 15 dB front-to-rear attenuation at 70 Hz
- Two subs stacked offers 12.5 dB front-to-rear attenuation at 70 Hz.
- Three subs stacked offers 10 dB front-to-rear attenuation at 70 Hz.

In addition, you can support a loudspeaker with the subwoofer in the stacked configuration.



WARNING!: Do not stack the KS212C units in a vertical orientation.

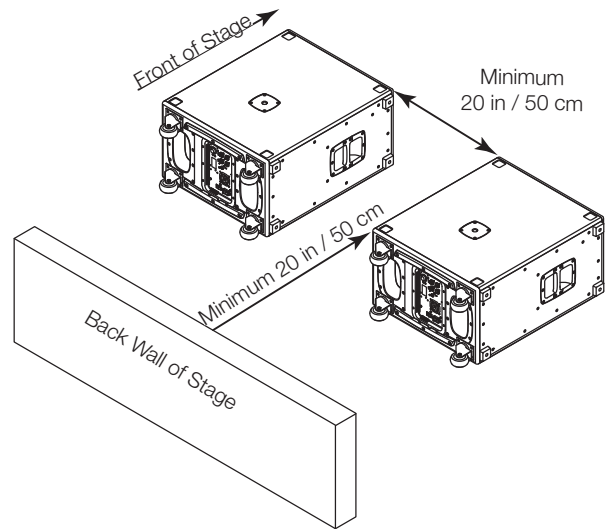

— Figure 3 —

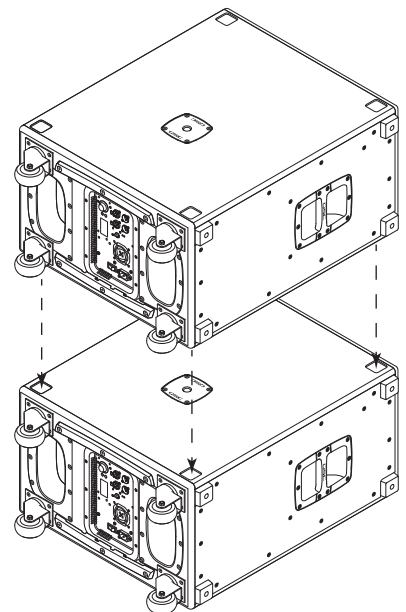

— Figure 4 —

KS112 Applications and Installation

Stacking the KS112

You can stack KS112 subwoofers in a horizontal orientation by matching the four rubber feet on the bottom of the top unit to the four cups on the top of the bottom unit. Refer to Figure 5.



WARNING!: The KS112 Subwoofer is not designed to be suspended. Do not suspend the KS112 Subwoofer.

Before placing, installing or mounting any speaker product, inspect all hardware, cabinets, transducers, brackets and associated equipment for damage. Any missing, corroded, deformed, or non-load rated component could significantly reduce the strength of the installation or placement. Any such condition severely reduces the safety of the installation and should be immediately corrected. Use only hardware which is rated for the loading conditions of the installation and any possible short-term, unexpected overloading.

Never exceed the rating of the hardware or equipment.

Consult a licensed, professional engineer regarding physical equipment installation. Ensure that all local, state and national regulations regarding the safety and operation of loudspeakers and related equipment are understood and adhered to.

Do not stack the KS112 units in a vertical orientation.

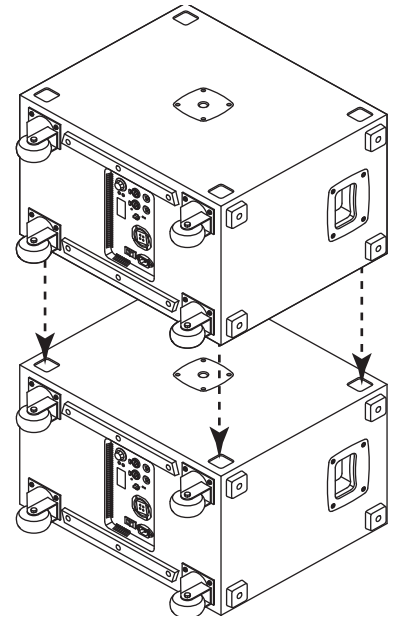

— Figure 5 —

Pole-mounting Loudspeakers Over the KS212C and KS112



NOTE: The KS212C is shown in Figure 6 and Figure 7. The features described in these two figures are the same for the KS112. Refer to the Stability Requirements charts below for individual requirements.

The KS Series Subwoofers are equipped with two 35 mm M20 pole sockets, one on the top, and one on the side for pole-mounting a loudspeaker over the unit.

Figure 6 shows a KS Series Subwoofer in a vertical orientation with a K.2 Series loudspeaker mounted above.

Figure 7 shows a KS Series Subwoofer in a horizontal orientation with a K.2 Series loudspeaker mounted above.

Use the appropriate Stability Requirements chart (below) to determine which poles you can use with the various K and K.2 Series loudspeakers when mounting them over your KS Series Subwoofer in a horizontal or vertical orientation.

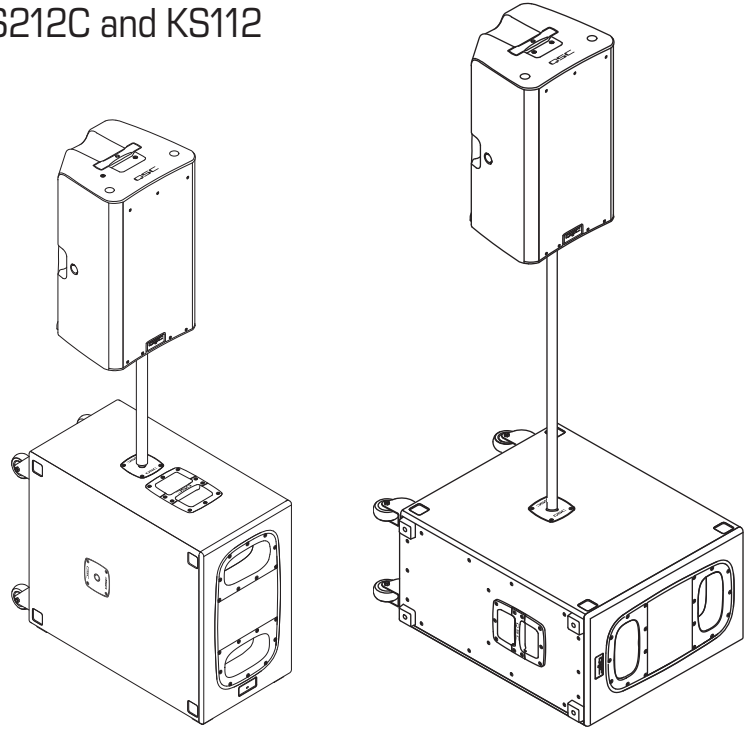

— Figure 6 —

— Figure 7 —

Stability Requirements for the KS212C Subwoofer

KS212C	K8/.2	K10/.2	K12/.2	KW122	KW152	KW153	1 x KLA12	2 x KLA12
Horizontal 16" Pole	Yes	Yes	Yes	Yes	Yes	Yes	Yes	Yes
Horizontal 26" Pole	Yes	Yes	Yes	Yes	Yes	Yes	Yes	Yes
Horizontal 36" Pole	Yes	Yes	Yes	Yes	Yes	Yes	Yes	Yes
Vertical 16" Pole	Yes	Yes	Yes	Yes	Yes	Yes	Yes	No
Vertical 26" Pole	Yes	Yes	Yes	Yes	Yes	No	Yes	No
Vertical 36" Pole	Yes	Yes	Yes	Yes	No	No	No	No

Stability Requirements for the KS112 Subwoofer

KS112	K8/.2	K10/.2	K12/.2	K8	K10	K12	KW122	KW152	KW153	1 x KLA12	2 x KLA12	E110
Horizontal 26" Pole	Yes	Yes	Yes	Yes	Yes	Yes	Yes	Yes	Yes	Yes	Yes	Yes
Horizontal 36" Pole	Yes	Yes	Yes	Yes	Yes	Yes	Yes	Yes	Yes	Yes	no	Yes
Vertical 26" Pole	Yes	Yes	No	Yes	Yes	No	No	No	No	No	No	No
Vertical 36" Pole	Yes	No	No	Yes	No	No	No	No	No	No	No	No



WARNING!: The KS Series Subwoofers are not intended or equipped for suspension. Do not suspend the unit.

Cooling

The KS Series Subwoofers are powered loudspeakers containing an internal power amplifier that produces heat. Allow a minimum of 50 cm (20 in) clearance around the cabinet for convection cooling. Keep anything that might restrict airflow away from the rear of the enclosure (i.e. draperies, walls, etc.)



CAUTION!: Do not install enclosures with their rear panels exposed to direct sunlight. Direct sunlight will heat the amplifier module and reduce its ability to produce full output. Install sunshades if needed. Maximum ambient temperature for full performance to specification is 50° C (122° F). Do not install enclosures where exposed to rain or other water sources. The enclosure is not weatherproof. Outdoor installations must provide protection from the elements.

AC Mains

Refer to Figure 8

AC Mains Disconnection

Push in on the bottom of the power switch to turn the amplifier off. Unplug the AC cable from the power source. To remove the AC mains cord from the amplifier, grasp the IEC connector's plastic body, press the yellow latch release button and pull. Do not pull the plug out using the cord.

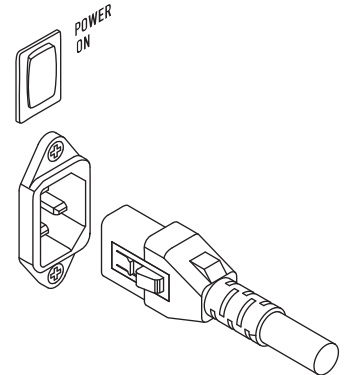

— Figure 8 —

Powering up Your KS Series Subwoofers

Connect the AC power cord to the IEC socket on the back of the amplifier. Make sure the plug is fully inserted into the IEC socket on the power amplifier module.



NOTE: Make sure that the AC power switch is in the OFF position before connecting AC power cord to the AC source.

Connect the AC Power cord to the facility's AC outlet.

The V-LOCK power cord has a special latching feature to prevent the power cord from being unintentionally removed. The IEC plug and socket are both blue in color so the power cord can be identified as a KS Series subwoofer cord. If the QSC-supplied cord is lost or damaged, a standard 18-gauge IEC power cord may be used. However, the latching system works only with a V-LOCK power cord. Available from QSC.

The KS212C subwoofers are equipped with a universal power supply that can use input AC power voltages ranging from 100 – 240 VAC at 50 – 60 Hz.



WARNING!: Use only the power cable that is correct for your location.

Power Switch

Push in on the top of the rocker switch to apply AC mains power to the amplifier. When power is applied to the amplifier, the blue POWER indicator LED illuminates.

Rear LED POWER Indicator

The blue LED POWER indicator on the rear panel will illuminate when the AC Power is applied. The rear LED POWER indicator will extinguish when the AC Power has been removed.

If the rear LED POWER indicator does not illuminate within the first 3 minutes after power is applied, verify the AC mains line cord is properly attached to the subwoofer and plugged into the AC outlet. Verify the outlet is functioning properly.



NOTE: If the AC mains cord is usable and the AC mains outlet is operating properly, but the unit fails to operate, the subwoofer may require servicing. Contact QSC's Technical Services department.

System Power Sequencing

Proper power turn on/turn off sequencing can help to prevent unexpected sounds from being produced by the system (pops, clicks, thumps). Always follow the rule that speakers are “last on, first off”.

Power-On Sequence:

1. Bring the output level control of the mixer (or other audio source) feeding your loudspeaker speaker loudspeaker system to its minimum position.
2. Turn on all source devices (CD players, mixers, instruments).
3. Turn on the KS Series subwoofers,
4. Turn on the “top-boxes”.
5. The level controls on your mixer may now be brought up.

Power-Off Sequence:

1. Turn off “top boxes.”
2. Turn off the KS Series subwoofers
3. Turn off all audio source devices.



NOTE: If a KS Series subwoofer is being driven from the output of another KS Series Subwoofer, it should be turned on after the unit feeding it signal, and turned off before the unit feeding it signal.

Block Diagram

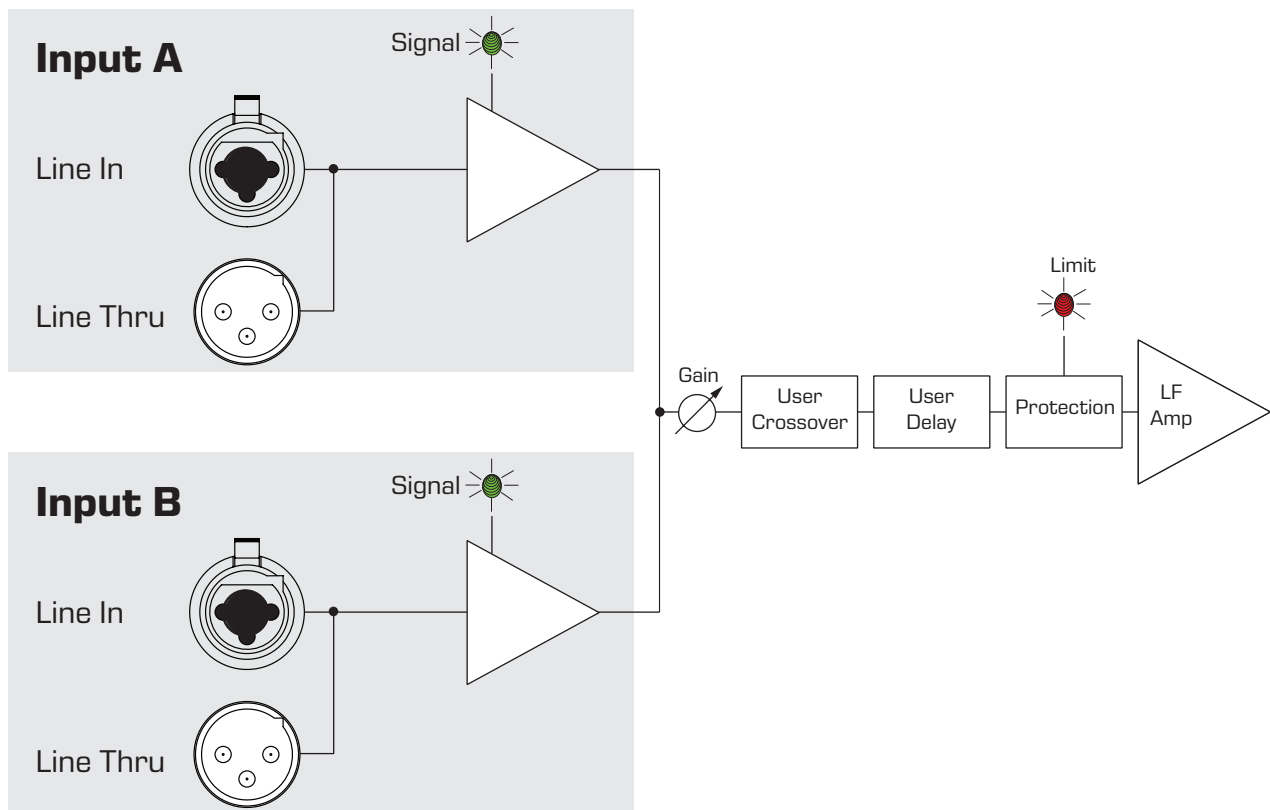

— Figure 9 —

Inputs and Outputs

The KS Series Subwoofer amplifier has two separate female combination XLR / 1/4" Phone Jack inputs, and two corresponding pre-gain pass-through male XLR outputs.

Refer to Figure 10

- SIG LED** – When illuminated (green), it indicates a signal is present for Input A and/or B. If this LED is not illuminated, the input signal is missing or too low to detect.
- IN A/B** – Combination XLR – 1/4" Phone Jack connector. Balanced XLR and 1/4" input. Accepts line-level, balanced or unbalanced inputs.
- Channel A and B pass-through output connectors. The signal here is the same as the input signal on Channel A and B. Use these to daisy-chain loudspeakers or to provide the signal to other audio equipment.
- LIMITER LED** – Illuminates (red) when the built-in limiter is activated to protect and avoid damage to the amplifier or loudspeaker. If the signal level at any frequency is too high, or the amplifier is too hot, the limiter is activated and the LED is illuminated.
- POWER LED** – Illuminates (blue) when power is applied to the unit and the ON/OFF switch is in the ON position.
- GAIN knob** – Sets the sensitivity of both Input A and B. Controls the signal level sent to the amplifier.

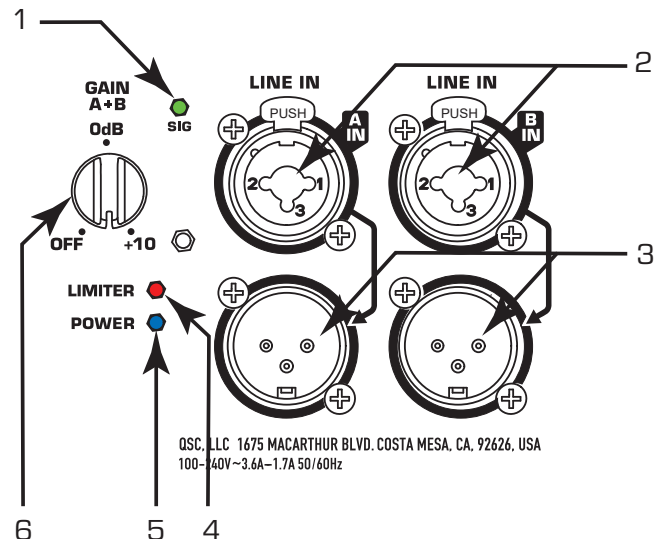

— Figure 10 —

Balanced Inputs

Connect the XLR plug as shown in Figure 11.

- Shield (ground)
- Positive
- Negative

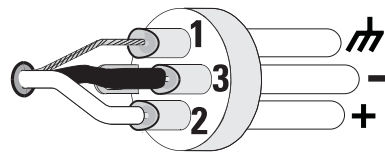

— Figure 11 —

Connect the TRS plug as shown in Figure 12. Do not use a TS 1/4" jack for balanced input.

- Shield (ground)
- Negative
- Positive

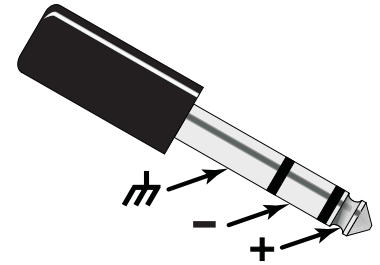

— Figure 12 —

Unbalanced Inputs

Connect the XLR plug as shown in Figure 13. (Jumper pins 1 and 3.)

- Shield (ground)
- Positive
- Negative

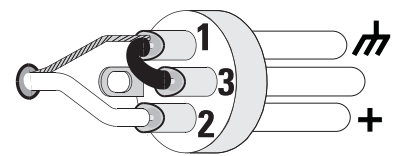

— Figure 13 —

Connect the TRS or TS plug as shown in Figure 14.

- Shield (ground)
- Negative
- Positive

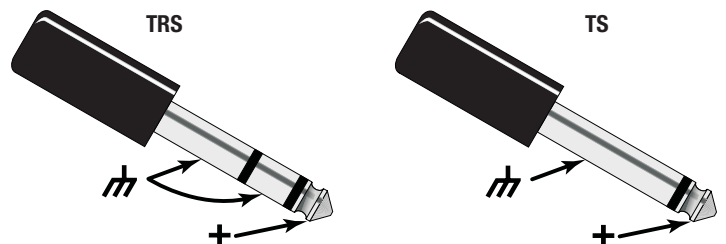

— Figure 14 —

KS Series Subwoofer's Menu

The KS Series Subwoofers feature a multi-function digital display for control and selection of various subwoofer functions including scenes, crossover, and delay.

Display Introduction

1. Home Screen – Displays the equipment model and the main functionality headings. Light background with black text indicates the item is selected.
2. Exit, or go back button – press to return to the previous screen or menu level.
3. Enter button – confirm a selected parameter or open the selected menu item.
4. Selector knob – move to another menu item, or change a selected parameter.
5. Left side, Home screen displays the parameter name.
6. Right side, Home screen displays the current state of the parameter.

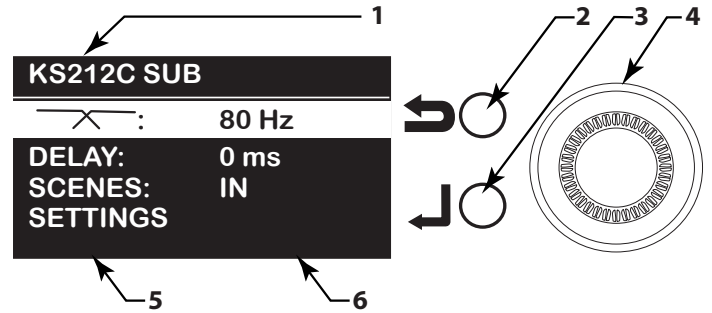

— Figure 15 —

Navigation Example:

To select a Preset:



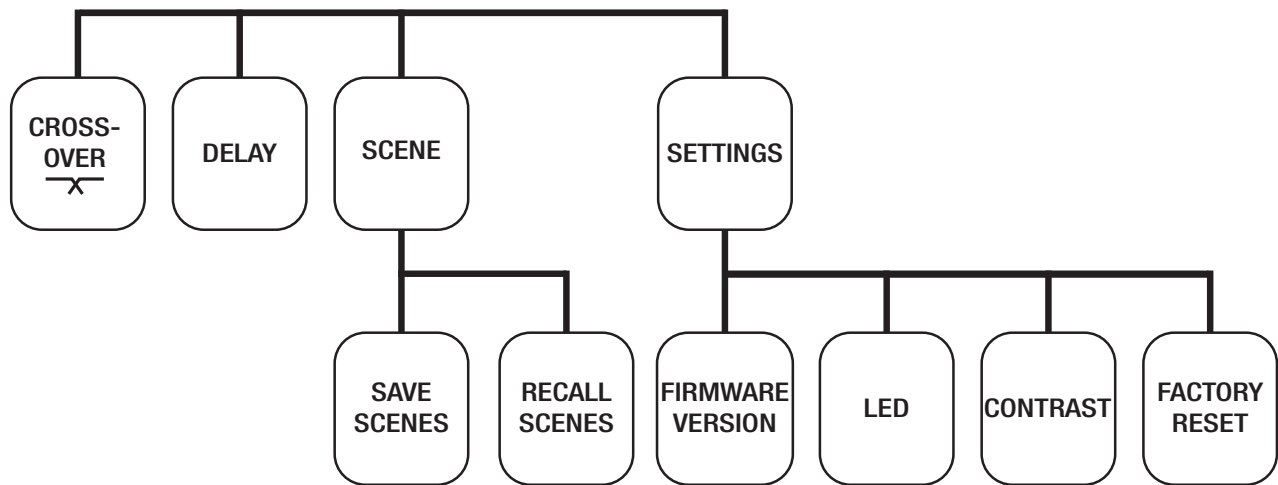

1. Turn the selector knob (4) clockwise to highlight the DELAY line.
2. Press the enter button (3) to access the DELAY submenu.
3. Turn the selector knob (4) clockwise or counterclockwise as needed to set the DELAY amount you want. The display is in ms, FEET and METERS.
4. Press the enter button (3) to confirm the DELAY amount and return to the main menu.

Menu Map

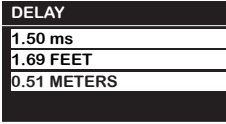
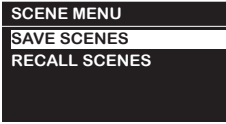
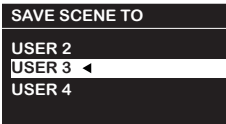

— Figure 16 —

Menu Listing

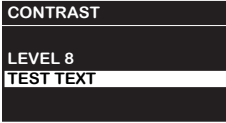
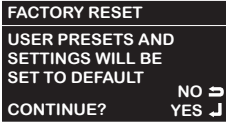
CROSSOVER		Select the CROSSOVER setting	
CROSSOVERS		<p>80 Hz – applies a 80 Hz low-pass filter. 80 Hz is optimized for the K.2 Series and future loudspeakers</p> <p>100 Hz – applies a 100 Hz low-pass filter. 100 Hz is optimized for the legacy K, KLA, and KW loudspeakers</p>	<p>Both of the crossover frequencies are time-aligned with the K.2 Series when the K.2 loudspeaker is pole-mounted over the KS Series and the front edges of the KS Series and K.2 Series loudspeakers are parallel.</p>
DELAY		Select the DELAY setting	
DELAY		<p>0 –100 milliseconds, 0 – 113 feet, 0 – 34 meters</p> <p>All units of measure change together when the selection knob is turned.</p>	
SCENE		Save or recall a user-defined SCENE	
SCENE MENU		<p>Use the selector knob to scroll (up or down) to the function you want</p>	
SAVE SCENE TO USER 1 – 5		<p>Use the selector knob to scroll (up or down) to select the scene name for the current settings. When you save a scene all the current settings in the amplifier are saved to that scene. Choose from User 1 through User 5, then press the enter button.</p>	<p>When saved, a triangle displays next to the saved scene, and the scene is the active scene.</p>
RECALL SCENE USER 1 – 5		<p>The active scene is indicated by the triangle to the right of the scene name. Use the selector knob to scroll (up or down) to select the scene you want to recall. Press the LOAD (enter) button to recall the selected scene.</p>	
SETTINGS		Utility functions	
SETTINGS menu		<p>Displays the loudspeaker model, firmware version (cannot edit this field) and the available utility selections. Use the selector knob to select the utility you want, then press the enter button.</p>	
LED		<p>Selects which combination of front and rear LEDs illuminate,</p>	
CONTRAST		<p>Adjusts the contrast of the LCD. Selections are 0 – 15, default is 8. The screen changes as you adjust.</p>	
FACTORY RESET		<p>Resets all parameters to the factory defaults, clears user presets – no undo.</p>	

KS112 Dimensions

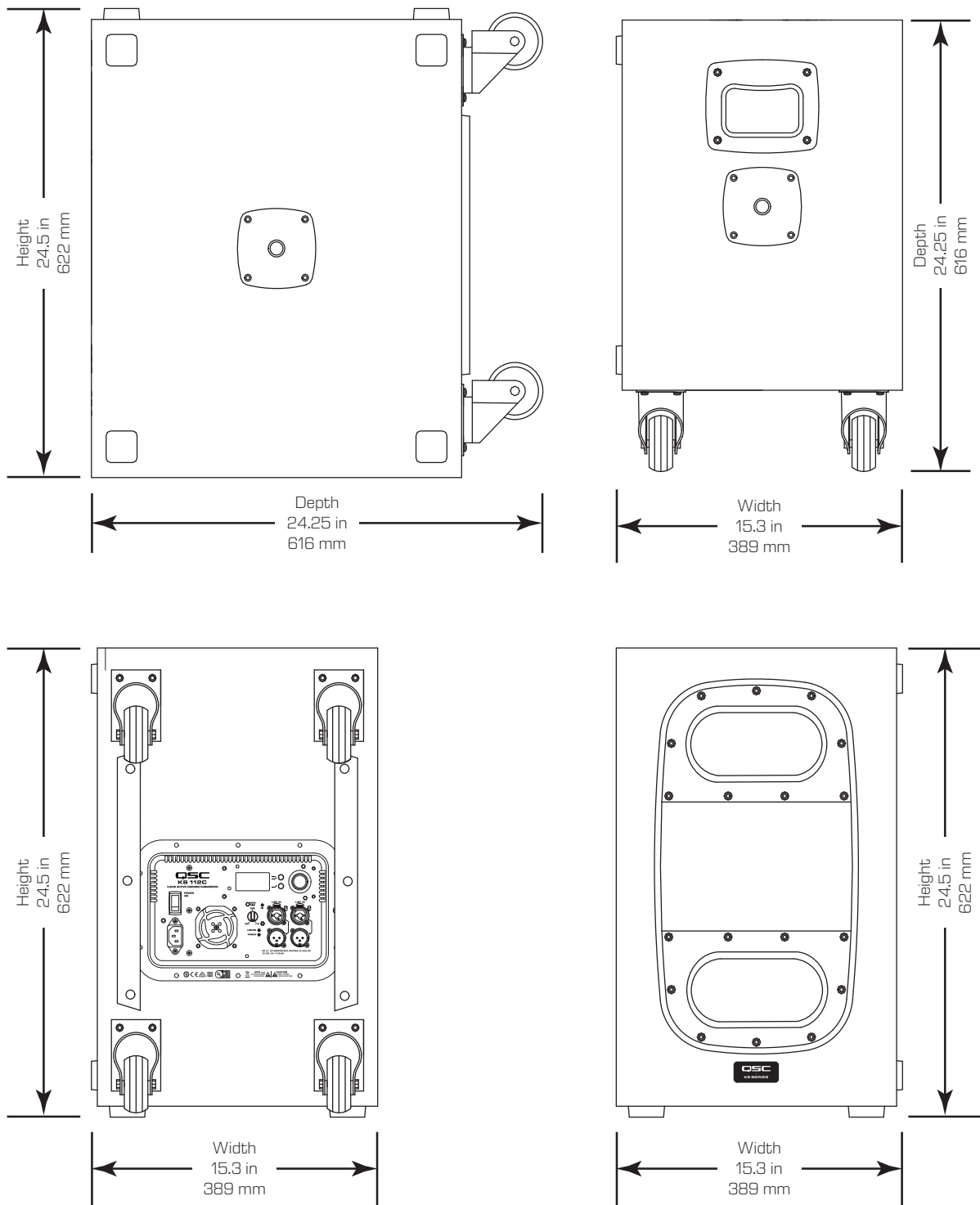

— Figure 17 —

KS212C Dimensions

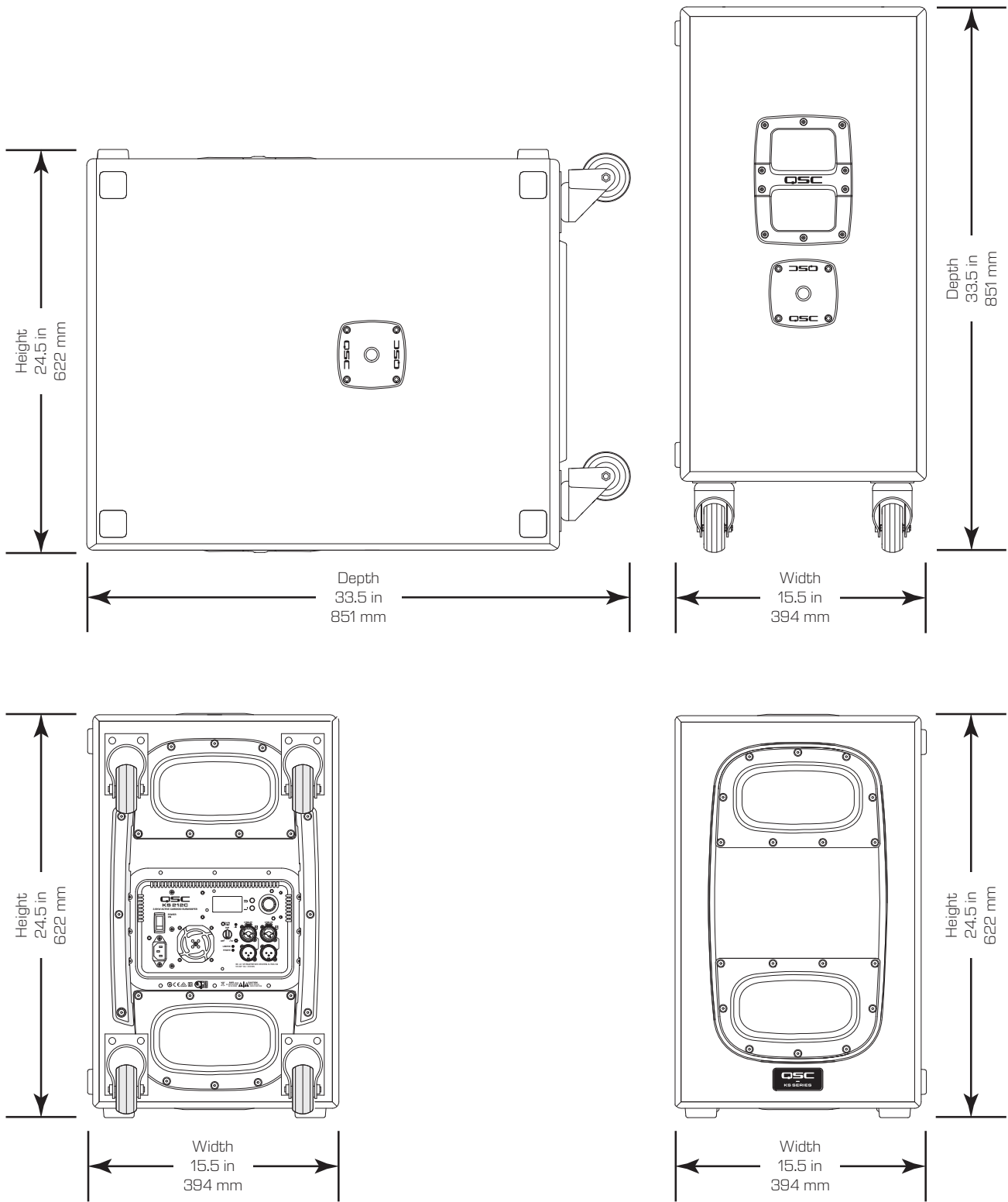

— Figure 18 —

Specifications

	KS212C	KS112
Configuration	Dual 6th-Order Bandpass Cardioid Subwoofer	6th-Order Bandpass Subwoofer
LF Transducer	2 x 12-inch (305 mm), Cone	12-inch (305 mm), Cone
Frequency Response (-6 dB)	44 - 104 Hz	41 - 108 Hz
Frequency Range (-10 dB)	39 - 118 Hz	38 - 121 Hz
Nominal Coverage Angle	180° Cardioid (15 dB rear rejection @ 70 Hz)	N/A
Maximum SPL	132 dB @ 1 m (peak)	128 dB @ 1 m (peak)
Amplifier	Class D 2 x 1800 W (peak)	Class D 2000 W (peak)
Cooling	Low-noise, Variable Speed Fan	Low-noise, Variable Speed Fan
Controls	Power On/Off Gain Control Rotary Encoder 2 x Selection Buttons	Power On/Off Gain Control Rotary Encoder 2 x Selection Buttons
Indicators	2 x Power LED (front and rear) Input Signal LED Limiter Active LED	2 x Power LED (front and rear) Input Signal LED Limiter Active LED
Connectors	2 x Locking XLR/F ¼-inch Combo 2 x XLR/M (Loop-thru Output) 1 x Locking IEC Power Connector	2 x Locking XLR/F ¼" combo 2 x XLR/M (Loop-thru Output) 1 x Locking IEC Power Connector
AC Power Input	Universal Power Supply 100 – 240 VAC, 50 – 60 Hz	Universal Power Supply 100 – 240 VAC, 50 – 60 Hz
AC Power Consumption (1/8th Power)	100 VAC, 3.6 A / 120 VAC, 3.0 A / 240 VAC, 1.7 A	100 VAC, 2.4 A / 120 VAC, 2.0 A / 240 VAC, 1.3 A
Enclosure Details		
Enclosure	18 mm Birch Plywood	15 mm Birch Plywood
Color	Black (RAL 9011)	Black (RAL 9011)
Grille	Internal Woofer Cover	Internal Woofer Cover
Dimensions (HxWxD): (Including casters)	622 x 394 x 851 mm 24.5 x 15.5 x 33.5 inches	622 x 394 x 616 mm 24.5 x 15.5 x 24.25 inches
Net Weight:	40.1 kg (88.5 lbs)	28.4 kg (62.6 lbs)
Shipping Weight:	48.5 kg (107 lbs)	34.5 kg (76 lbs)
Regulatory:	CE, WEEE, UL, China RoHS, RoHS II, FCC Class B	CE, WEEE, UL, China RoHS, RoHS II, FCC Class B
Included Accessories:	4 x Low-noise, Heavy-duty Casters 35 mm, M20, 915 mm (36 in) long Loudspeaker Pole (SP-36)	4 x Low-noise, Heavy-duty Casters
Optional Accessories:	KS212C-CVR Cover, KS LOC Lock-Out Cover, 16-inch SP-16X Extension Pole	KS112 Cover, KS-LOC Lock-Out Cover, 16-inch SP-16X Extension Pole, 36-inch SP-36 Speaker Pole



NOTE: Specifications subject to change without notice.



Mailing Address:

QSC, LLC
1675 MacArthur Boulevard
Costa Mesa, CA 92626-1468 U.S.
Main Number: +1.714.754.6175
World Wide Web: www.qsc.com

Sales & Marketing:

Voice: +1.714.957.7100 or toll free (U.S. only)
800.854.4079
FAX: +1.714.754.6174
E-mail: info@qsc.com

QSC Technical Services

1675 MacArthur Blvd.
Costa Mesa, CA 92626 U.S.
Tel: 800.772.2834 (U.S. only)
Tel: +1.714.957.7150
FAX: +1.714.754.6173
service@qsc.com