



Roland



4-CHANNEL
PORTABLE RECORDER

R-44

Owner's Manual

- * Microsoft and Windows are registered trademarks of Microsoft Corporation.
- * Windows® is known officially as: “Microsoft® Windows® operating system.”
- * Apple and Macintosh are registered trademarks of Apple Inc.
- * Mac OS is a trademark of Apple Inc.
- * All product names mentioned in this document are trademarks or registered trademarks of their respective owners.
- * The SD logo () and SDHC logo () are trademarks of SD-3C, LLC.
- * Fugue © 1999–2013 Kyoto Software Research, Inc. All rights reserved.



- * MMP (Moore Microprocessor Portfolio) refers to a patent portfolio concerned with microprocessor architecture, which was developed by Technology Properties Limited (TPL). Roland has licensed this technology from the TPL Group.

For the U.K.

IMPORTANT: THE WIRES IN THIS MAINS LEAD ARE COLOURED IN ACCORDANCE WITH THE FOLLOWING CODE.

BLUE: NEUTRAL
BROWN: LIVE

As the colours of the wires in the mains lead of this apparatus may not correspond with the coloured markings identifying the terminals in your plug, proceed as follows:

The wire which is coloured BLUE must be connected to the terminal which is marked with the letter N or coloured BLACK.

The wire which is coloured BROWN must be connected to the terminal which is marked with the letter L or coloured RED.

Under no circumstances must either of the above wires be connected to the earth terminal of a three pin plug.

For the USA



DECLARATION OF CONFORMITY Compliance Information Statement

Model Name : R-44E
Type of Equipment : Portable Recorder
Responsible Party : Roland Systems Group U.S.
Address : 5100 S. Eastern Avenue, Los Angeles, CA 90040-2938
Telephone : (323) 890-3700







USING THE UNIT SAFELY

INSTRUCTIONS FOR THE PREVENTION OF FIRE, ELECTRIC SHOCK, OR INJURY TO PERSONS

About  WARNING and  CAUTION Notices

 WARNING	Used for instructions intended to alert the user to the risk of death or severe injury should the unit be used improperly.
 CAUTION	Used for instructions intended to alert the user to the risk of injury or material damage should the unit be used improperly. * Material damage refers to damage or other adverse effects caused with respect to the home and all its furnishings, as well to domestic animals or pets.

About the Symbols

	The  symbol alerts the user to important instructions or warnings. The specific meaning of the symbol is determined by the design contained within the triangle. In the case of the symbol at left, it is used for general cautions, warnings, or alerts to danger.
	The  symbol alerts the user to items that must never be carried out (are forbidden). The specific thing that must not be done is indicated by the design contained within the circle. In the case of the symbol at left, it means that the unit must never be disassembled.
	The  symbol alerts the user to things that must be carried out. The specific thing that must be done is indicated by the design contained within the circle. In the case of the symbol at left, it means that the power-cord plug must be unplugged from the outlet.

ALWAYS OBSERVE THE FOLLOWING

WARNING

To completely turn off power to the unit, pull out the plug from the outlet

Even with the power switch turned off, this unit is not completely separated from its main source of power.



When the power needs to be completely turned off, turn off the power switch on the unit, then pull out the plug from the outlet. For this reason, the outlet into which you choose to connect the power cord's plug should be one that is within easy reach and readily accessible.

Concerning the Auto Off function

The power to this unit will be turned off automatically after a predetermined amount of time has passed since it was last used for playing music, or its buttons or controls were operated (Auto Off function). If you do not want the power to be turned off automatically, disengage the Auto Off function (p. 71).



Do not disassemble or modify by yourself

Do not carry out anything unless you are instructed to do so in the owner's manual. Otherwise, you risk causing malfunction.



WARNING

Do not repair or replace parts by yourself

Refer all servicing to your retailer, the nearest Roland Service Center, or an authorized Roland distributor, as listed on the "Information."



Do not use or store in the following types of locations

- Subject to temperature extremes (e.g., direct sunlight in an enclosed vehicle, near a heating duct, on top of heat-generating equipment); or are
- Damp (e.g., baths, washrooms, on wet floors); or are
- Exposed to steam or smoke; or are
- Subject to salt exposure; or are
- Exposed to rain; or are
- Dusty or sandy; or are
- Subject to high levels of vibration and shakiness.



Do not place in an unstable location

Otherwise, you risk injury as the result of the unit toppling over or dropping down.



WARNING

Use only the supplied AC adaptor and the correct voltage

Be sure to use only the AC adaptor supplied with the unit. Also, make sure the line voltage at the installation matches the input voltage specified on the AC adaptor's body. Other AC adaptors may use a different polarity, or be designed for a different voltage, so their use could result in damage, malfunction, or electric shock.



Use only the supplied power cord

Use only the attached power cord. Also, the supplied power cord must not be used with any other device.



Do not bend the power cord or place heavy objects on it

Otherwise, fire or electric shock may result.



Avoid extended use at high volume

Use of the unit at high volume for extended periods of time may cause hearing loss. If you ever experience any hearing loss or ringing in the ears, you should immediately stop using the unit and consult a specialized physician.



⚠ WARNING

Do not allow foreign objects or liquids to enter unit; never place containers with liquid on unit

Do not place containers containing liquid (e.g., flower vases) on this product. Never allow foreign objects (e.g., flammable objects, coins, wires) or liquids (e.g., water or juice) to enter this product. Doing so may cause short circuits, faulty operation, or other malfunctions.



Turn off the unit if an abnormality or malfunction occurs

Immediately turn the unit off, remove the AC adaptor from the outlet, and request servicing by your retailer, the nearest Roland Service Center, or an authorized Roland distributor, as listed on the "Information" when:



- The AC adaptor or the power cord has been damaged; or
- If smoke or unusual odor occurs; or
- Objects have fallen into, or liquid has been spilled onto the unit; or
- The unit has been exposed to rain (or otherwise has become wet); or
- The unit does not appear to operate normally or exhibits a marked change in performance.

Be cautious to protect children from injury

Always make sure that an adult is on hand to provide supervision and guidance when using the unit in places where children are present, or when a child will be using the unit.



Do not drop or subject to strong impact

Otherwise, you risk causing damage or malfunction.



Do not share an outlet with an unreasonable number of other devices

Otherwise, you risk overheating or fire.



⚠ WARNING

Do not use overseas

Before using the unit in overseas, consult with your retailer, the nearest Roland Service Center, or an authorized Roland distributor, as listed on the "Information."



Handle batteries carefully

If used improperly, you risk the dangers of fluid leakage, overheating, combustion, explosion, etc. Carefully observe the following:

- Do not heat, disassemble, or toss them into a fire or water.
- Do not expose them to sunlight, flame, or any other source of extreme heat.
- Do not attempt to charge a dry cell battery.
- When using a rechargeable battery and a charger, make sure to use only the combination of rechargeable battery and charger that has been specified by the battery manufacturer. Also, be sure to read all of the precautions that were supplied with the rechargeable battery and charger, and abide by them when using the battery/charger.



Handle lithium batteries carefully

- Lithium batteries must never be recharged, heated, taken apart, or thrown into a fire or water.
- Keep lithium batteries out of reach of small children. If a child has accidentally swallowed a battery, see a doctor immediately.
- Never expose lithium batteries to excessive heat such as sunshine, fire or the like.



⚠ CAUTION

Place in a well ventilated location

The unit and the AC adaptor should be located so their location or position does not interfere with their proper ventilation.



When disconnecting the power cord, grasp it by the plug

To prevent conductor damage, always grasp the power cord by its plug when disconnecting it from this unit or from a power outlet.



Periodically clean the power plug

An accumulation of dust or foreign objects between the power plug and the power outlet can lead to fire or electric shock.



At regular intervals, be sure to pull out the power plug, and using a dry cloth, wipe away any dust or foreign objects that may have accumulated.

Disconnect the power plug whenever the unit will not be used for an extended period of time

Fire may result in the unlikely event that a breakdown occurs.



Route all power cords and cables in such a way as to prevent them from getting entangled

Injury could result if someone were to trip on a cable and cause the unit to fall or topple.



Avoid climbing on top of the unit, or placing heavy objects on it

Otherwise, you risk injury as the result of the unit toppling over or dropping down.



Never connect/disconnect a power plug if your hands are wet

Otherwise, you could receive an electric shock.



⚠ CAUTION

Disconnect all cords/cables before moving the unit

Before moving the unit, disconnect the power plug from the outlet, and pull out all cords from external devices.



Before cleaning the unit, disconnect the power plug from the outlet

If the power plug is not removed from the outlet, you risk receiving an electric shock.



Whenever there is a threat of lightning, disconnect the power plug from the outlet

If the power plug is not removed from the outlet, you risk receiving an electric shock.



Handle batteries carefully

If used improperly, batteries may explode or leak and cause damage or injury. In the interest of safety, please read and observe the following precautions.



- Carefully follow the installation instructions for batteries, and make sure you observe the correct polarity.
- Avoid using new batteries together with used ones. In addition, avoid mixing different types of batteries.
- Remove the batteries whenever the unit is to remain unused for an extended period of time.
- Never keep batteries together with metallic objects such as ballpoint pens, necklaces, hairpins, etc.
- Used batteries must be disposed of in compliance with whatever regulations for their safe disposal that may be observed in the region in which you live.

⚠ CAUTION

Handle the ground terminal carefully

If you remove the screw from the ground terminal, be sure to replace it; don't leave it lying around where it could accidentally be swallowed by small children. When refastening the screw, make that it is firmly fastened, so it won't come loose.



Precautions concerning use of phantom power supply

Always turn the phantom power off when connecting any device other than condenser microphones that require phantom power. You risk causing damage if you mistakenly supply phantom power to dynamic microphones, audio playback devices, or other devices that don't require such power. Be sure to check the specifications of any microphone you intend to use by referring to the manual that came with it.



This instrument's phantom power: 48 V DC, 8 mA Max (Total of all channels must be 20 mA or less)

Take care not to get burned

Batteries may reach a high temperature; please be careful to avoid burning yourself.



Handle leaking batteries carefully

- Do not touch the liquid with your bare hands.
- If any of the leaking fluid gets into your eyes, the loss of vision may result. Do not rub your eyes; use clean water to flush them thoroughly. Then, promptly see a doctor.
- Burning of the skin or dermatitis may result if fluid has gotten onto your skin or clothing. Use clean water to flush affected areas thoroughly; then, promptly see a doctor.
- Using a soft cloth, carefully wipe any remaining fluid from the inside of the battery compartment. Then, install new batteries.



IMPORTANT NOTES

Power Supply

- Do not connect this unit to same electrical outlet that is being used by an electrical appliance that is controlled by an inverter or a motor (such as a refrigerator, washing machine, microwave oven, or air conditioner). Depending on the way in which the electrical appliance is used, power supply noise may cause this unit to malfunction or may produce audible noise. If it is not practical to use a separate electrical outlet, connect a power supply noise filter between this unit and the electrical outlet.
- The AC adaptor will begin to generate heat after long hours of consecutive use. This is normal, and is not a cause for concern.
- The use of an AC adaptor is recommended as the unit's power consumption is relatively high. Should you prefer to use batteries, please use the alkaline batteries or rechargeable Ni-MH batteries.
- If the unit has been used with a power supply that has not been specified as suitable for the unit, the subsequent performance and operation of the unit can no longer be guaranteed. Also note that we may not be able to accept the unit for servicing and repairs.

Power Supply: Use of Batteries

- Before installing/removing batteries, make sure to turn off the power to this unit and disconnect all connections to other devices.
- If operating this unit on batteries, please use the alkaline batteries or rechargeable Ni-MH batteries.

Placement

- Using the unit near power amplifiers (or other equipment containing large power transformers) may induce hum. To alleviate the problem, change the orientation of this unit; or move it farther away from the source of interference.
- This unit may interfere with radio and television reception. Do not use this unit in the vicinity of such receivers.
- Noise may be produced if wireless communications devices, such as cell phones, are operated in the vicinity of this unit. Such noise could occur when receiving or initiating a call, or while conversing. Should you experience such problems, you should relocate such wireless devices so they are at a greater distance from this unit, or switch them off.

- Do not expose the unit to direct sunlight, place it near devices that radiate heat, leave it inside an enclosed vehicle, or otherwise subject it to temperature extremes. Excessive heat can deform or discolor the unit.
- When moved from one location to another where the temperature and/or humidity is very different, water droplets (condensation) may form inside the unit. Damage or malfunction may result if you attempt to use the unit in this condition. Therefore, before using the unit, you must allow it to stand for several hours, until the condensation has completely evaporated.
- Depending on the material and temperature of the surface on which you place the unit, its rubber feet may discolor or mar the surface. You can place a piece of felt or cloth under the rubber feet to prevent this from happening. If you do so, please make sure that the unit will not slip or move accidentally.
- Do not place containers or anything else containing liquid on top of this unit. Also, whenever any liquid has been spilled on the surface of this unit, be sure to promptly wipe it away using a soft, dry cloth.

Maintenance

- For everyday cleaning wipe the unit with a soft, dry cloth or one that has been slightly dampened with water. To remove stubborn dirt, use a cloth impregnated with a mild, non-abrasive detergent. Afterwards, be sure to wipe the unit thoroughly with a soft, dry cloth.
- Never use benzene, thinners, alcohol or solvents of any kind, to avoid the possibility of discoloration and/or deformation.

Repairs and Data

- Before sending the unit away for repairs, be sure to make a backup of the data stored within it; or you may prefer to write down the needed information. Although we will do our utmost to preserve the data stored in your unit when we carry out repairs, in some cases, such as when the memory section is physically damaged, restoration of the stored content may be impossible. Roland assumes no liability concerning the restoration of any stored content that has been lost.

Additional Precautions

- Any data stored within the unit can be lost as the result of equipment failure, incorrect operation, etc. To protect yourself against the irretrievable loss of data, try to make a habit of creating regular backups of the data you've stored in the unit.
- Roland assumes no liability concerning the restoration of any stored content that has been lost.
- Use a reasonable amount of care when using the unit's buttons, sliders, or other controls; and when using its jacks and connectors. Rough handling can lead to malfunctions.
- Never strike or apply strong pressure to the display.
- When disconnecting all cables, grasp the connector itself—never pull on the cable. This way you will avoid causing shorts, or damage to the cable's internal elements.
- To avoid disturbing others nearby, try to keep the unit's volume at reasonable levels.
- When you need to transport the unit, pack it in shock-absorbent material. Transporting the unit without doing so can cause it to become scratched or damaged, and could lead to malfunction.

Using External Memories

- Please observe the following precautions when handling external memory devices. Also, make sure to carefully observe all the precautions that were supplied with the external memory device.
 - Do not remove the device while reading/writing is in progress.
 - To prevent damage from static electricity, discharge all static electricity from your person before handling the device.

Contents

USING THE UNIT SAFELY	3
IMPORTANT NOTES	6
Checking the Included Items	8
Introducing the R-44	9
Names of Things and What They Do.....	9
Display.....	18
Projects.....	22
Getting Ready to Use the R-44 ...	24
Connecting the AC Adaptor and Turning the Power On/Off.....	24
Installing Batteries and Turning on the Power.....	25
Preparing the SD Memory Card	28
Recording	29
Recording from a Connected Microphone	29
Recording from the Internal Mics.....	33
Recording Digital Audio from a Digital Device	34
Simultaneously Recording Sound from Connected Microphones and a Digital Device	35
Simultaneously Recording Sound from Connected External Microphones and the Internal Mics.....	37
Recording Digital Audio from an Analog Device	39
Simultaneously Recording Sound from Connected Microphones and an Analog Device	40
Playing Back	42
Connections Before Playback	42
Connecting Headphones	42
Connecting Amplified Speakers.....	42
Connecting a Mixer or Other Analog Device	42
Connecting a Device Having a Digital Input Port.....	43
Setup Before Playback.....	44
Player Setup.....	44
Speaker Settings.....	45
Playing Back.....	46
Normal Playback	46
Markers	47
Repeat Playback (A-B REPEAT).....	48
Specifying the Project Playback Order (Playlist Function).....	49
Manipulating a Project (Finder) ..	50
Selecting a Project (Select)	50
Renaming a Project (Rename).....	51
Copying a Project (Copy)	52
Moving a Project (Move)	53
Deleting a Project (Delete).....	54
Creating a New Folder (Make Folder).....	55
Repairing a Project (Repair)	56
Setting the Color of Sound (Effects Settings)	57
Applying Effects	58
Effects	60
System Setup	62
Example Operations	63
Recording Setup.....	63
Date & Time Settings.....	64
Project Name Settings	65
Formatting and Checking the SD Memory Card	66
Executing Factory Reset (Restoring Factory Default Settings).....	67
System Menu	68
Appendix	73
Connecting to a Computer	73
Connecting the R-44 to Your Computer.....	73
Disconnecting the R-44 from a Computer.....	74
Remotely Linking Two Connected R-44 Units.....	75
Messages	76
Troubleshooting	77
Main Specifications	81
Block Diagram	83
Index	84

Before using this unit, carefully read the sections entitled: "USING THE UNIT SAFELY" and "IMPORTANT NOTES" (p. 3–6). These sections provide important information concerning the proper operation of the unit. Additionally, in order to feel assured that you have gained a good grasp of every feature provided by your new unit, Owner's Manual should be read in its entirety. The manual should be saved and kept on hand as a convenient reference.

Copyright © 2013 ROLAND CORPORATION

All rights reserved. No part of this publication may be reproduced in any form without the written permission of ROLAND CORPORATION.

Roland is a registered trademark of Roland Corporation in the United States and/or other countries.

Checking the Included Items

The R-44 comes with the following items. Please check that all of these items are present after opening the package. If any items are missing, please contact the retailer from whom you purchased the R-44.

■ R-44

■ AC Adaptor

This AC adaptor is designed specifically for the R-44. Do not attempt to use any other adaptor with the R-44.

■ USB Cable (mini B TYPE; 1 meter)

You can use this cable to connect the R-44 to the USB connector of your computer.

** If the AC adaptor or USB cable becomes damaged or if you need a replacement for any reason, please contact one of the Service Centers listed in the "Information" section at the end of this manual.*

** Don't remove the ferrite core that's attached to the USB cable.*

■ Owner's Manual

This is the document you're reading. Keep it at hand for ready reference.

Introducing the R-44

Names of Things and What They Do

Top Panel

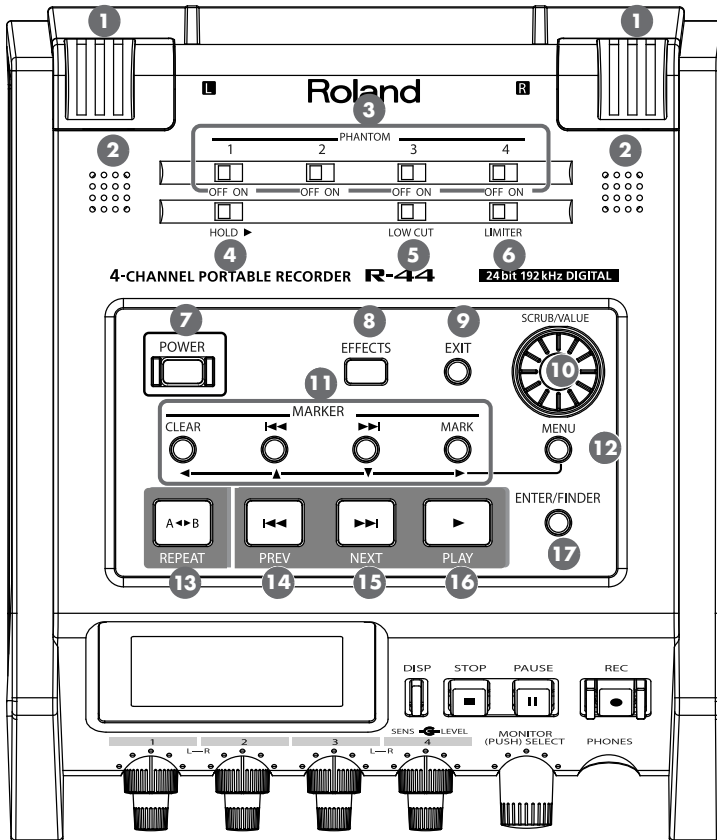

1 Internal Mics [MIC-L, MIC-R]

These stereo mics are built into the R-44. The audio entering MIC-L is recorded on the 1L channel, and the audio from MIC-R is recorded on the 1R channel. If you are recording with the internal mics, set the System Settings menu item **Recording Setup** to **Int-Mic**.

For details, refer to **“Recording from the Internal Mics”** (p. 33).

* Do not connect anything to input jacks that are not used.

2 Internal Speakers

These built-in speakers are for monitoring sound. If you want sound to be played from the internal speakers, set the System Settings menu item **Speaker** to **ON**. For details, refer to **“Speaker Settings”** (p. 45).

* No sounds are played from the internal speakers if headphones are connected to the **Headphone jack 25**. Sound is not played from the internal speakers while recording or in recording-standby mode to prevent acoustic feedback.

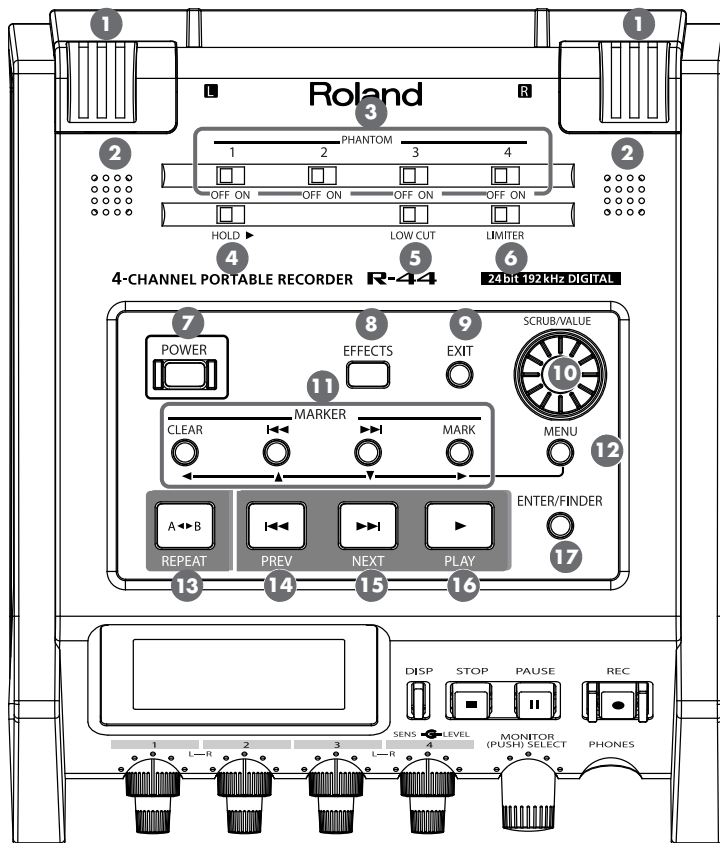

3 Phantom Power Switches [PHANTOM POWER]

These switches turn the phantom power on/off for the XLR connectors of the combo input jacks located on the right panel. You can turn phantom power on/off separately for channels 1/2/3/4 because they have separate switches.

** Always turn the phantom power off when connecting any device other than condenser microphones that require phantom power. You risk causing damage if you mistakenly supply phantom power to dynamic microphones, audio playback devices, or other devices that do not require such power. Be sure to check the specifications of any microphone you intend to use by referring to the manual that came with it.*

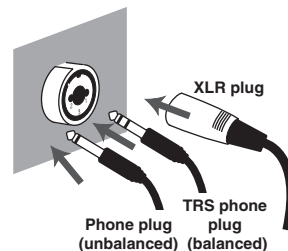

4 Hold Switch [HOLD]

By selecting the **HOLD ON** position, you can disable the panel buttons so that unwanted operations will not occur if a button is pressed accidentally.

However, even if this switch is set to HOLD ON, the **Phantom power switches** 3, **Low cut switch** 5, **Limiter switch** 6, **Input level knobs** 23, and **Monitor level knob** 24 will still be operable.

5 Low Cut Switch [LOW CUT]

Tuning this switch on allows you to record while cutting the lower range portion of the input signal. Turn it on when breath noise (breathing sounds during voice recording) or wind noise (when recording outside) may be a problem.

6 Limiter Switch [LIMITER]

This switch turns the input level limiter on/off.

The limiter compresses the input level appropriately to prevent distortion when the input level is too high. The limiter can be set to work with respect to each channel independently or for a combination of channels (linked). For details, refer to **“Limiter link”** (p. 70).

7 Power Switch [POWER]

This switch turns the power on/off. To turn the power on or off, press and hold the **[POWER] switch** for about two seconds. The **[POWER] switch** is lit blue when the power is on.

* *Do not turn off power to the R-44 in the following situations. The SD memory card may be damaged.*

- When writing to or reading from the SD memory card, such as during recording or playback
If power is mistakenly turned off during recording, the recorded data may not be saved on the SD memory card.

Note that pressing the power switch during recording will not turn off power.

- When “Now Processing!” or “Checking Card...” appears on the R-44’s display
- When connected to a PC

8 Effects Button [EFFECTS]

This button puts the R-44 in Effect mode, where you can make effect settings. When effects are operating, the Effect button lights in orange.

For details, refer to “**Setting the Color of Sound (Effects Settings)**” (p. 57).

9 Exit Button [EXIT]

You use this button to return to the previous screen or to cancel an operation.

10 Scrub Dial [SCRUB/VALUE]

Use this dial to select a setting item or to change a value. You can also turn the scrub dial to move the current location forward or backward when the R-44 is stopped or when playback is paused.

In the finder screen, the scrub dial can also be used to select songs.

**11 Marker Buttons [CLEAR] [◀◀] [▶▶] [MARK] /
Cursor Buttons [▲] [▼] [◀] [▶]**

When using as Marker buttons (p. 47)

Clear button [CLEAR]

This button deletes markers assigned with the **[MARK] button**. Markers are deleted successively, starting at the marker located immediately before the current location.

Marker button [◀◀]

This button moves the position to the marker immediately before the current location (the previous marker).

If the current playback location is before the first marker, pressing this button moves the position to the beginning of the project. The position is also moved to the beginning of the project if no markers have been set.

Marker button [▶▶]

This button moves the position to the marker immediately following the current location (the next marker).

If the current playback location is at the last marker, pressing this button moves the position to the end of the project. The position is also moved to the end of the project if no markers have been set.

Mark button [MARK]

You assign a marker to a desired location in the project file by pressing this button. Markers are numbered sequentially from the beginning of the project.

When using as Cursor button

You use these buttons to select items shown in the display.

12 MENU Button [MENU]

This button puts the R-44 in different modes where you can make various settings.

For details, refer to “**System Setup**” (p. 62).

13 A-B Repeat Button [A-B REPEAT]

This button lets you repeatedly play the region between two points (A and B) in the project. Simply assign marker A and marker B while the project is playing, and playback will repeat between markers A and B.

For details, refer to “**Repeat Playback (A-B REPEAT)**” (p. 48).

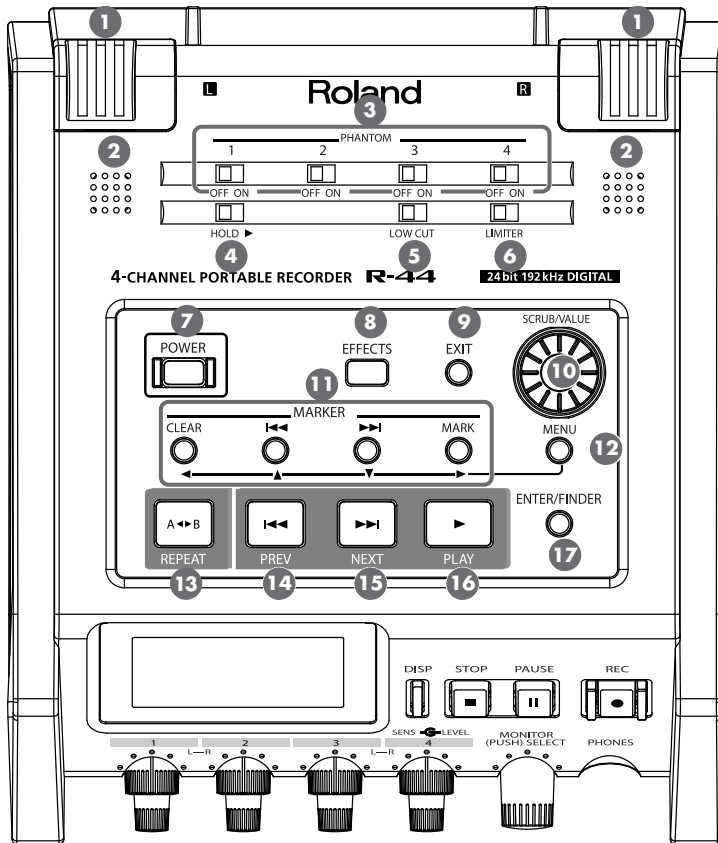

14 PREV Button [PREV]

Pressing the **[PREV] button** while a project is playing or stopped returns the project to the beginning (00:00:00.00). Pressing this button at the beginning of a project moves to the previous project. You can also press and hold down this button to rewind. This feature is available both while playing and while stopped.

* If **Play Mode** is set to **Single** in the **Player Setup** system setting, you cannot move to the previous or next project during playback.

15 NEXT Button [NEXT]

Pressing the **[NEXT] button** jumps to the next project. You can also press and hold this button to fast-forward. This feature is available both while playing and while stopped.

* If **Play Mode** is set to **Single** in the **Player Setup** system setting, you cannot move to the previous or next project during playback.

16 Play Button [PLAY]

This button starts playback. The **[PLAY] button** is lit blue during playback.

17 Enter/Finder Button [ENTER/FINDER]

You use this button to confirm a setting or to set a value. You can also press this button to use the Finder function. For more about the Finder function, refer to **“Manipulating a Project (Finder)”** (p. 50).

Front Panel

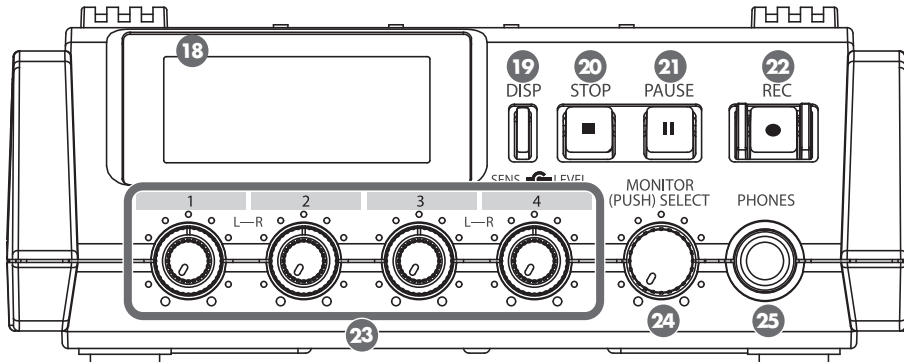

18 Display

The display shows information about the R-44's status. For details, refer to “**Display**” (p. 18).

19 Display Button [DISP]

This button switches the contents of the R-44's display. For details, refer to “**Display**” (p. 18).

20 Stop Button [STOP]

This button stops playback or recording. If you press the [STOP] button during playback, the timer counter displays the time when you pressed the [STOP] button.

21 Pause Button [PAUSE]

This button pauses playback or recording. During recording, sound is still output even if paused.

22 Record Button [REC]

Recording will begin immediately when you press the [REC] button. The [REC] button is lit red during recording. If you hold down the [PAUSE] button and press the [REC] button, the [REC] button will blink red, and the R-44 enters recording standby mode. Recording will begin when you press the [REC] button or [PAUSE] button 21.

23 Input Level Knobs 1–4 [LEVEL]/[SENS]

These knobs adjust the input level from each **Combo input jack 1–4** 34 (p. 30). You can adjust sensitivity to 11 levels: +4, -2, -8, -14, -20, -26, -32, -38, -44, -50, and -56 dBu. You can also set the level from negative infinity to +8 dB, with the central position at 0 dB.

* When using **Internal mics** 1, sensitivity can be set to one of three levels (Low, Mid, or Hi) and the level can be set from negative infinity to +18 dB. Also, sensitivity for both MIC-L and MIC-R can be adjusted with **Input level knob 1**. The level for MIC-L can be adjusted with **Input level knob 1**, and the level for MIC-R can be adjusted with **Input level knob 2**.

24 Monitor Level Knob [MONITOR (PUSH) SELECT]

This knob adjusts the output volume from the **Internal speakers** 2 and the **Headphone jack** 25. This knob does not adjust the volume from the **Line output jacks** 33. If you want to adjust the volume of the Line output jacks, adjust the controls of the external speakers or playback system connected to the Line output jacks.

You can press the this knob from the main screen to select a channel to monitor. For details, refer to “**Display**” (p. 18).

25 Headphone Jack [PHONES]

You can connect a set of headphones with this jack. Use the **Monitor level knob** 24 to adjust the volume. If you connect headphones, no sound is output from the **Internal speakers** 2.

Side Panel (Left)

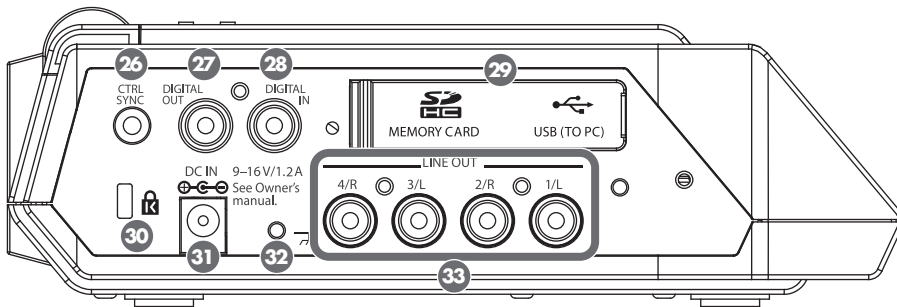

26 Control Sync Connector [CTRL SYNC]

You can perform clock-synchronized recording of up to 8 channels by connecting two R-44 units with a mini-type stereo cable via the CTRL SYNC connectors. You can also remotely link recording standby, start, and stop.

For details, refer to **“Remotely Linking Two Connected R-44 Units”** (p. 75).

* *Remote linking does not guarantee that two R-44 units will start recording at the same time. There will be a discrepancy of several milliseconds.*

27 Digital Output Jack [DIGITAL OUT]

This connector outputs a digital signal. You can connect digital devices, such as speakers or mixers, with a coaxial type cable. This connector provides the same audio signal as the **Headphone jack** 25, but in digital form.

* *The volume cannot be adjusted with the **Monitor level knob** 24.*

28 Digital Input Jack [DIGITAL IN]

Connect an XLR type cable to this connector to record a digital signal. The digital input signal is recorded in stereo on channels 1L and 1R. If you want to record in monaural, you must change the **Rec Mode** setting in the System Settings menu. For details, refer to **“1 Recording Setup”** (p. 68).

29 Rubber Flap

Open this cover to expose the **Memory card slot** and **USB connector**.

Memory card slot [MEMORY CARD SLOT]

You can insert an SD memory card into this slot.

USB connector [USB]

You can connect the R-44 to your computer with the included USB cable and move or copy recorded projects. You can also move or copy files from your computer to the SD memory card.

For details, refer to **“Connecting to a Computer”** (p. 73).

30 Security Slot ()

You can attach a commercial available security cable to this slot to prevent theft.

<http://www.kensington.com/>

31 AC Adaptor Jack [DC IN]

You can connect either the included AC adaptor or a commercially available cable for an external power device.

For details, refer to **“Connecting the AC Adaptor and Turning the Power On/Off”** (p. 24).

32 Grounding Terminal

Depending on how the system is setup, you may experience discomfort or perceive that the surface feels gritty when you touch this device, microphones connected to it, or the metal portions of other objects, such as guitars. This sensation is caused by an infinitesimal electrical charge, which is absolutely harmless. However, if you are concerned about this, connect the ground terminal to an external ground. When the unit is grounded, a slight hum may occur, depending on the setup. If you are unsure of how to connect a ground, contact the nearest Roland Service Center or an authorized Roland distributor, as listed on the "Information" page.

Do not connect to these objects

- Water pipes (may result in shock or electrocution)
- Gas pipes (may result in fire or explosion)
- Telephone-line ground or lightning rod (may be dangerous in the event of lightning)

33 Line Output Jacks [LINE OUT]

These jacks output an analog audio signal. You can use RCA cables to connect powered speakers, audio equipment, mixers, and other devices. The regulated output level is fixed at -20 dBu.

* *The volume for each channel during playback can be adjusted on the Mixer screen (p. 19).*

* *Line output can be output as 4-indiv or monitor. Refer to "5 System Setup" in System settings (p. 71) for details.*

Side Panel (Right)

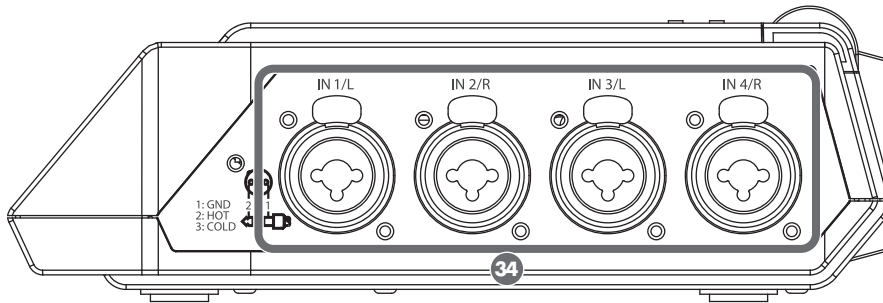

34 Combo Input Jacks 1–4

These analog audio input connectors are compatible with mic preamps. They support either XLR or phone plugs, which can be selected to match the connected device. They also accept either balanced or unbalanced connections.

You can use Combo input jacks 1–4 as four channels of monaural input or as two stereo pairs, 1/2 and 3/4. For details, refer to “1 Recording Setup” (p. 68).

* The XLR type supports 48 V phantom power and allows you to connect phantom-powered condenser microphones. In this case, turn on the **Phantom power switch** 3 on the top panel.

The R-44 is equipped with balanced (XLR/TRS) type connectors. The wiring diagrams for these connectors are shown at right. Connect them after first checking the wiring diagrams of the device you intend to connect.

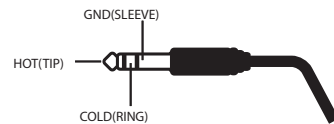

* If connection cables with resistors are used, the volume level of devices connected to the inputs (Combo input jacks 1–4) may be low. If this happens, use connection cables that do not contain resistors.

* To disconnect an XLR-type cable, push the metal latch while you unplug the connector.

Bottom Panel

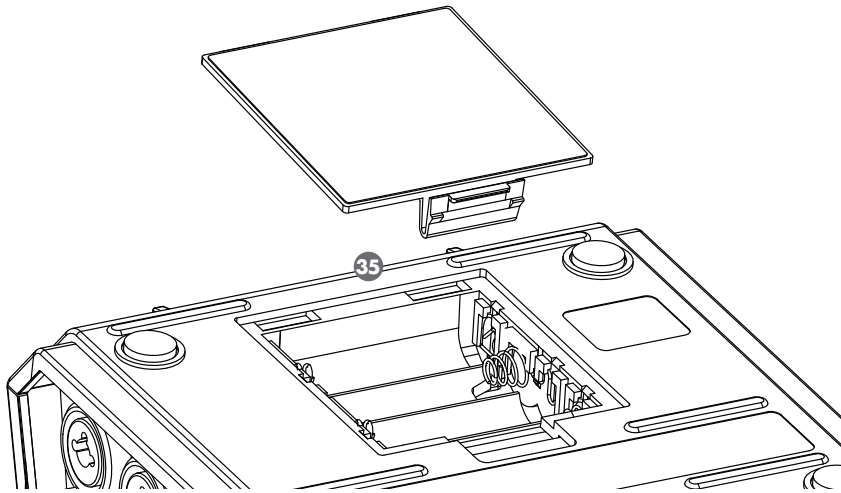

35 Battery Compartment

Install batteries here if you want to operate the R-44 on battery power.

The orientation of the batteries is shown inside the battery compartment.

Be sure to observe the correct polarity when installing the batteries.

If using the AC adaptor, you do not need to install batteries.

When the R-44 has sufficiently charged batteries, the power source automatically switches between battery and external power when the AC adaptor jack is connected or disconnected.

For details, refer to **"Installing Batteries and Turning on the Power"** (p. 25).

Display

While Playing or Stopped

The Main screen

The R-44's Main screen displays information about the project and the operational status of the R-44. You can press the **[DISP]** button to change the contents of the display.

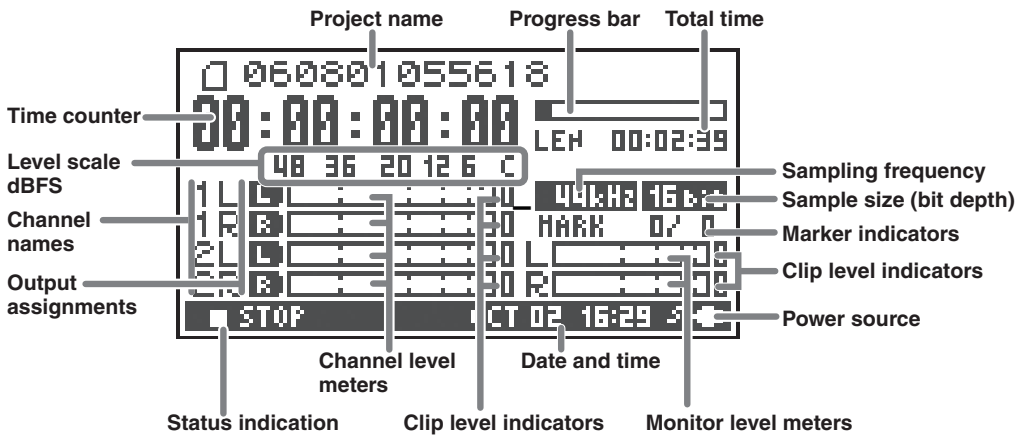

Project name	Displays the name of the project. The file name is shown when you copy WAV files from your computer via USB to the R-44's SD memory card. File names containing double-byte characters (e.g., Japanese) are not displayed correctly, but such files can be played.
Time counter	Displays the time elapsed from the beginning of the project to the current position in hour:minute:second:1/100 second format.
Progress bar	Displays the current playback location relative to the entire project.
Total time (LEN: Length)	Displays the total time of the entire project.
Level scale dBFS	Displays the sound level for each channel (after adjusting input levels) in real time.
Clip level indicators	The markings are relative to 0 dBFS (Full Scale) of the digital signal. For example, 12 indicates -12 dBFS. C is the clipping level (0 dBFS).
Channel names	Displays up to four channel names. When using one stereo channel, 1L and 1R are shown. When using two stereo channels, 1L, 1R, 2L, and 2R are shown. For monaural projects, 1, 2, 3, and/or 4 is shown according to the number of channels. When the sensitivity setting is too high and clipping occurs the display is shown in inverted black and white.
Output assignments	Displays how the audio of each channel is assigned to the L/R output channels. L means that the audio is output to the left channel, R to the right channel, and LR to both left and right channels. Channels that are not shown are not output. You can select a channel to be monitored by pressing the Monitor Level knob . You can also restore the default settings by pressing and holding down the Monitor Level knob for one second. The output is sent to the PHONES jack, Line output jacks, and digital output jack. <i>* When Output Sel (p. 71) in the system settings is set to "monitor," the Line output jacks output sound as set in the output assignments.</i>
Sampling frequency	Displays the sampling frequency and sample size (bit depth) of the currently selected project.
Sample size (bit depth)	

Marker indicator	The number on the left is the number of the marker located immediately before the current time counter value. The number on the right indicates the total number of markers assigned in the currently selected project. E indicates the end of the current project.
Monitor level meters	These are the output level meters. The output level assigned to the L/R channels of the monitor is displayed as the final output level after mixing the L and R channels separately. You can adjust the level of each channel with the channel level sliders from the Mixer screen. The level meter is calibrated at -36, -20, -12, -6, or -3 dBFS from the left.
Clip level indicators	
Power source	Displays the power supply source for the R-44. When power is supplied via the AC adaptor, a power plug icon is shown; when power is supplied via batteries or an external power supply device (p. 27), a battery icon is displayed.
Date and time	Displays the current date and time (p. 64, p. 72).

If you press the **[DISP]** button from the Main screen, the level meters will be shown in a magnified view. Also, the progress bar will change to indicate the remaining time of the project (REM : REMAIN).

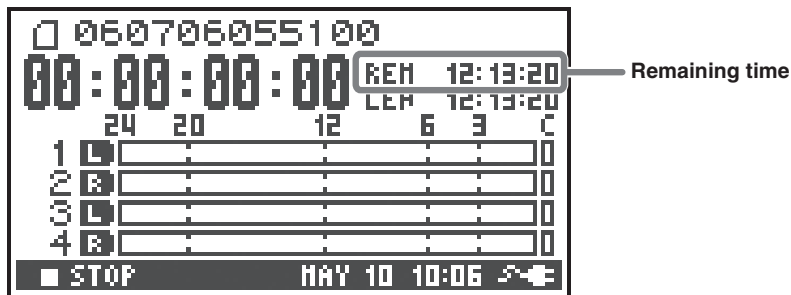

Remaining time	Displays the remaining time during playback from the current location to the end of the project.
-----------------------	--

The Mixer screen

From the Main screen, press the **[DISP]** button twice to show the Mixer screen. This screen lets you adjust the volume balance for monitoring.

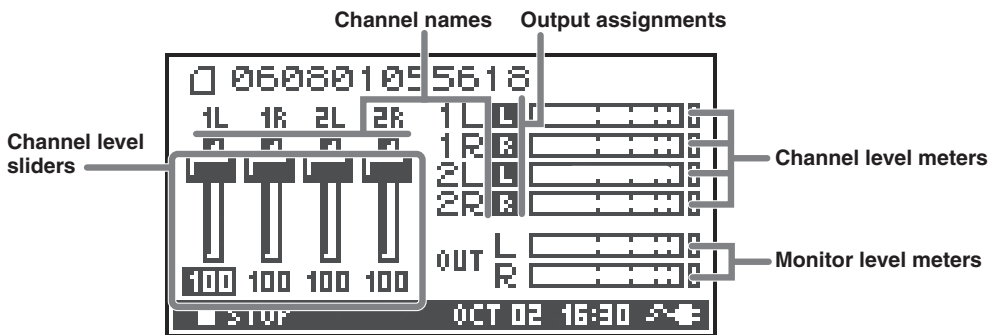

Channel level sliders	<p>These sliders adjust the playback level for each channel. Use the CURSOR buttons [◀][▶] to select a slider, and turn the [SCRUB/VALUE] dial to adjust the value. Each slider can be adjusted within the range 0–120. The default value is 100.</p> <ul style="list-style-type: none"> * The settings are stored by the R-44 and not in the project. When you turn off the power, the settings revert to the default value. * These settings do not affect the recording levels.
------------------------------	--

While Recording or in Recording Standby

The Main screen

The R-44's Main screen displays information about the project and the operational status of the R-44. You can press the **[DISP]** button to change the contents of the display.

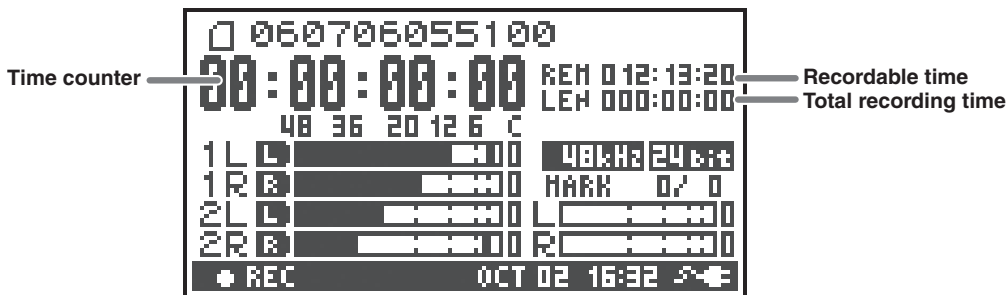

Time counter	Displays the time elapsed from the beginning of the project to the current position in hour:minute:second:1/100 second format.
Recordable time	Displays the time that recording can take place.
Total recording time	Displays the total time from the beginning of recording to the current location. * Even if you record continuously, another new project will be created automatically when the project reaches 2 GB in size, and recording will continue. Even for recordings spanning multiple projects, the elapsed time since you first pressed the [REC] button is shown here.

* For an explanation of the other displays, refer to "While Playing or Stopped" (p. 18).

If you press the **[DISP]** button from the Main screen, the level meters will be shown in a magnified view. Also, the recordable time area will change to indicate the remaining capacity of the SD memory card.

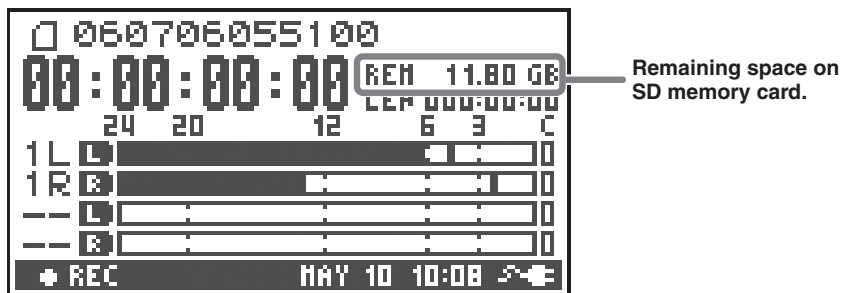

Remaining space on SD memory card	Displays the amount of free space on the SD memory card.
--	--

From the Main screen, press the **[DISP]** button twice to show the recording buffer capacity (BUF: buffer gauge).

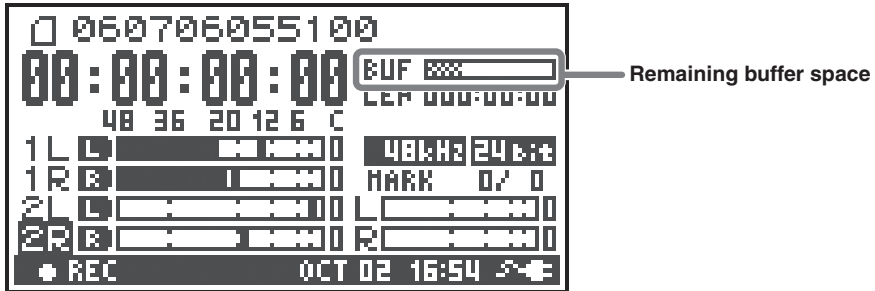

The recording buffer is memory that temporarily stores the input sound before it is written to the SD memory card. The buffer gauge indicates how much of the recording buffer has been used. Normally, the recording buffer never reaches capacity because input sound is immediately written to the SD memory card. However, if the SD memory card processing capability decreases and writing data to the SD memory card is delayed, then the data may accumulate to an excess and the buffer may overflow. (The SD memory card processing capability may be affected if file arrangement on the card becomes irregular due to project files being repeatedly written and deleted. If such a situation is encountered, you can restore the card to its original processing capability by formatting it.)

- * When the recording buffer is close to capacity, the “SD buffering” message is displayed.
- * When the recording buffer reaches capacity, the buffer gauge moves all the way to the right edge and the “SD Card Slow!” message is shown. Recording does not stop even if the “SD Slow” message is displayed, but some sound is not recorded. This message will not disappear until a button is pressed.
- * For important recordings, we recommend formatting the SD memory card before use.
- * Some SD memory cards may have a slow writing speed, so that even immediately after they have been formatted, recording at a high bit rate may cause a similar message to be displayed. When purchasing an SD memory card, please check whether it has been verified to work correctly with the R-44 (p. 78).

Projects

On the R-44, the data that you record and play back are handled in units called projects. On the SD memory card, each project actually consists of a folder with one or more files, as shown below.

If you connect the R-44 to your computer, you can see how these folders and files are organized. However, if you change, delete, or rename the files within a project, the R-44 may be unable to play that project. Please use caution.

In the system settings, the **Recording Setup** parameter **Rec Mode** (p. 69) lets you specify the type of project you want to record.

Monaural projects

Type	Structure
MONOx1	If there is only one channel, a monaural WAV file will be created with a name consisting of the project name and a .wav extension.
MONOx2 MONOx3 MONOx4	If there are 2–4 channels, a folder will be created with a name consisting of the project name plus an extension of .pjt . In that folder, monaural WAV files will be created with names consisting of the channel number and a .wav extension.

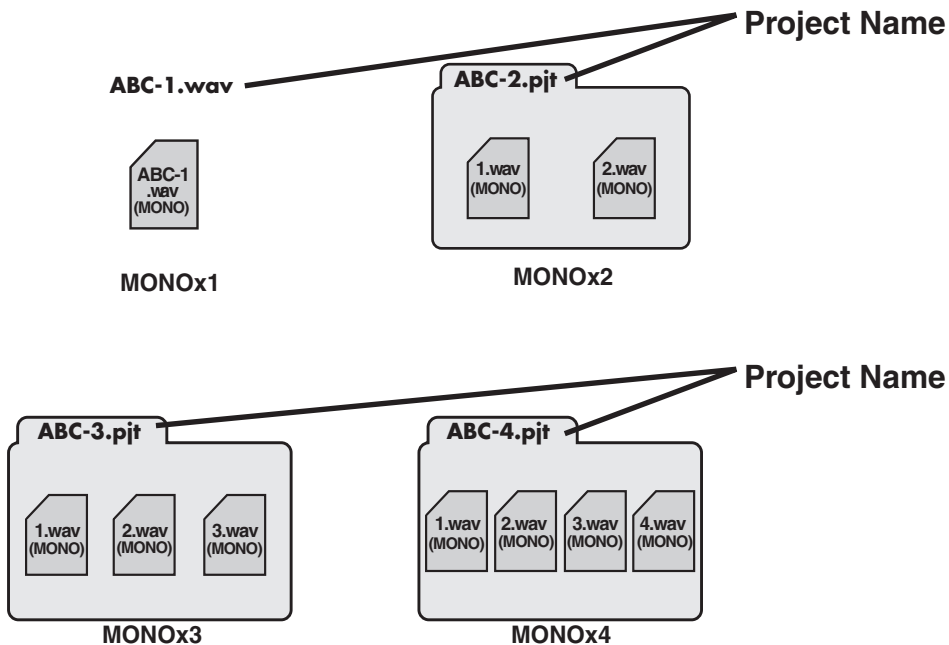

Stereo projects

Type	Structure
STEREOx1	If there is only one stereo channel pair, a stereo WAV file will be created with a name consisting of the project name and a .wav extension.
STEREOx2	If there are two stereo channel pairs, a folder will be created with a name consisting of the project name plus an extension of .pjt . In that folder, stereo WAV files will be created with names consisting of the channel number and a .wav extension.

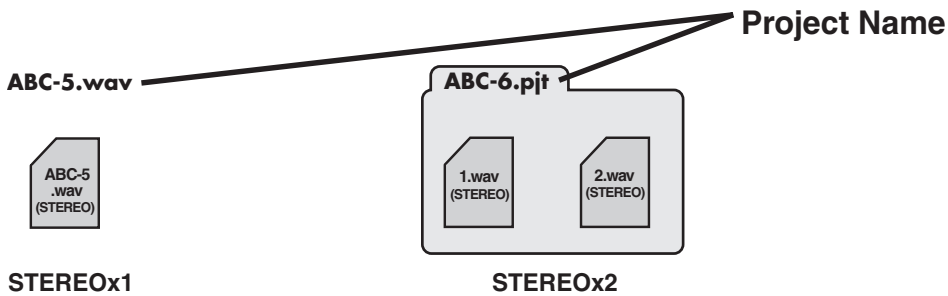

Four-channel projects

Type	Structure
4CH	A four-channel WAV file will be created with a name consisting of the project name and a .wav extension.

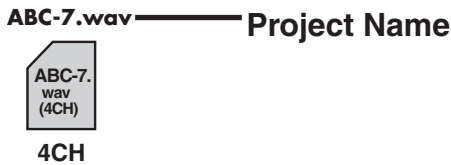

** If you want to load these files onto your computer, make sure that your waveform editing software supports four-channel files.*

Limitations on file size

The R-44 can handle files up to 2 GB in size. If the file size reaches 2 GB during recording, the file is closed. Then, a new file is created and recording continues. When you finish recording, these files appear as separate projects.

About BWF

In “5 System Setup” (p. 71), under system settings, you can set Project File to BWF so that the files created during recording and editing will be BWF files. BWF (Broadcast Wave Format) files contain information about the recording time and recording device (Roland R-44) in addition to the data of a conventional WAV file. The file can be used by waveform editing software that supports BWF.

Caution when copying files from your computer

Be aware of the following when copying files from your computer to the R-44’s SD memory card.

- The R-44 can play only linear PCM WAV files at sampling frequencies of 44.1, 48, 88.2, 96, or 192 kHz and bit depths of 16 or 24 bits. It cannot play any other type of file.
- File and folder names containing double-byte characters (e.g., Japanese) are not displayed correctly.
- Any files other than WAV files cannot be recognized by the R-44 and will not be displayed.
- Files beginning with “.” (dot) will not be displayed.
- You must not copy files larger than 2 GB into the R-44’s SD memory card. Doing so will make the R-44’s operation unstable, and in the worst case might even damage the files in the SD memory card.

Getting Ready to Use the R-44

Connecting the AC Adaptor and Turning the Power On/Off

- * Once the connections have been completed, turn on power to your various devices in the order specified. By turning on devices in the wrong order, you risk causing malfunction and/or damage to speakers and other devices.
- * Reduce the volume before turning on power. Even when the volume is turned down, sound may be produced when turning on the power. This is not a defect.
- * If you connect the AC adaptor when batteries are installed, the power will be supplied from the AC adaptor.
- * Place the AC adaptor so the side with the indicator (refer to illustration) faces upwards and the side with textual information faces downwards. The indicator will light when you plug the AC adaptor into an AC outlet.

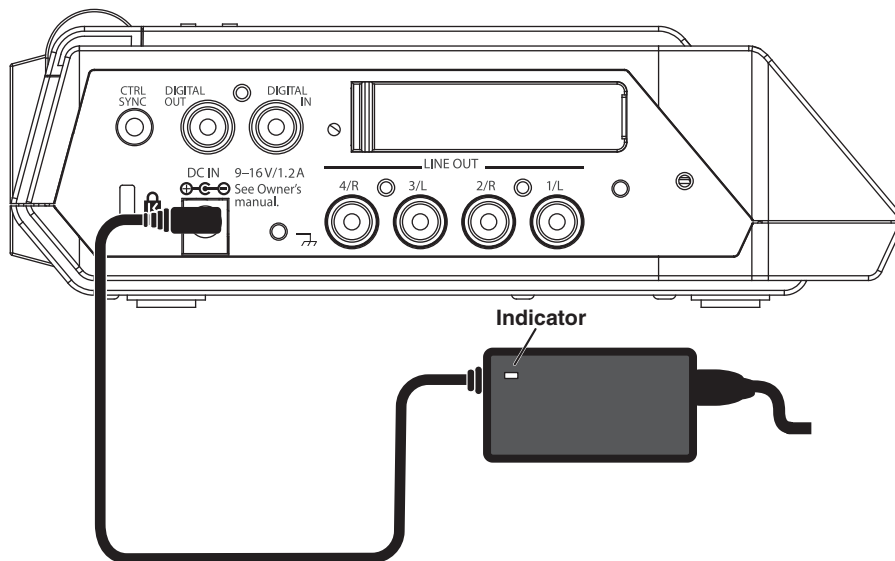

Turning on the power

- 1 Insert the AC adaptor into the **AC adaptor jack** on the R-44's side panel (left).
 - * Use only the included AC adaptor.
- 2 Plug the AC adaptor into an AC power outlet.
- 3 To turn the power on, press and hold the **[POWER] switch** for about two seconds.

Wait until the Main screen appears.

- * Due to a circuitry protection feature, this unit requires a few moments after power-up before it is ready for normal operation.

Turning off the power

- 1 Confirm that recording/playback has been stopped.
- 2 While the Main screen is displayed, press and hold the **[POWER] switch** for about 2 seconds to turn the power off.

- * If there are batteries in the unit while an AC adaptor is being used, normal operation will continue should the line voltage be interrupted (power blackout or power cord disconnection).

Installing Batteries and Turning on the Power

Types of batteries that can be used

- Alkaline batteries (AA, LR6) and rechargeable nickel metal-hydride battery (AA, HR6) only
- * *The R-44 cannot recharge nickel metal-hydride batteries. You must use a separate charger.*
- * *You must specify the type of batteries in the R-44's **System Settings menu item "5 System Setup"** (p. 71). The R-44 will not operate correctly if the specified battery type does not match the actual batteries.*

1 Make sure that the R-44 is turned off, and disconnect the AC adaptor from the **AC adaptor jack** on the R-44's side panel (left).

2 Detach the battery cover from the bottom panel of the R-44.

- * *When turning the unit upside-down, handle with care to avoid dropping it, or allowing it to fall or tip over.*
- * *When turning the unit upside-down, place newspapers or magazines under the four corners or at both ends to prevent damage to the buttons and controls. Also, you should try to orient the unit so no buttons or controls get damaged.*

3 Insert four AA batteries into the **battery compartment**, making sure to observe the correct polarity (+ and - symbols).

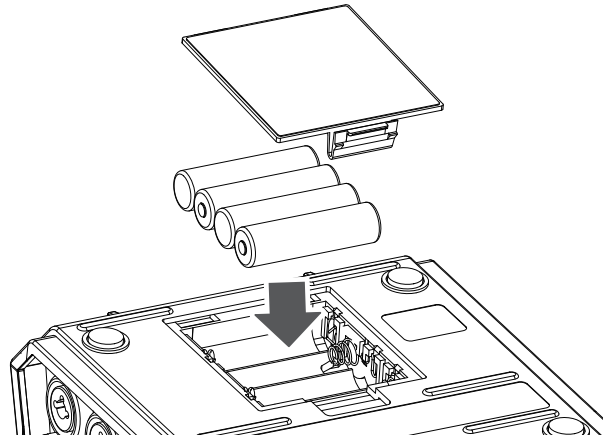

4 Replace the battery cover.

5 Turn on the R-44.

6 Press the **[MENU] button**.

7 Use the **Cursor buttons [▲] [▼]** to select **5 System Setup**.

8 Press the **[ENTER] button**.

9 Using the **[SCRUB/VALUE] dial**, set the **Battery Type** to **Alkaline** if installing alkaline batteries or to **Ni-MH** if installing nickel metal-hydride batteries. The setting is activated as soon as you select it.

10 When finished with the setting, press the **[EXIT] button** to return to the previous screen.

11 When you have returned to the **System Menu** screen, press the **[EXIT] button** once again.

The **[ENTER] button** will be blinking on the display. Press the **[EXIT] button** to return to the Main screen if you do not need to make additional settings.

Caution when using battery power on the R-44

- If you operate on battery power for an extended time, the batteries will become hot. Be careful not to burn yourself.
- Do not mix new batteries with used batteries or mix batteries of differing types.
- If you will not be using the R-44 for an extended time, we recommend that you remove the batteries to prevent leakage or other accidents.
- When using a USB cable to connect the R-44 to your computer, use the AC adaptor to prevent the loss of power while the connection is active.

Battery Status

When using the R-44 on battery power, a battery icon is shown in the lower right of the display. As battery capacity decreases, the battery icon changes as follows.

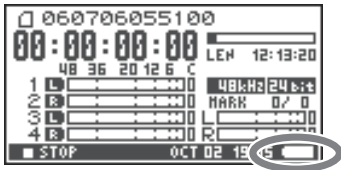
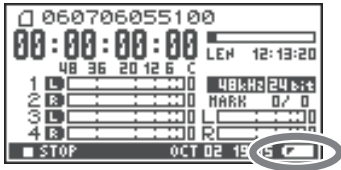
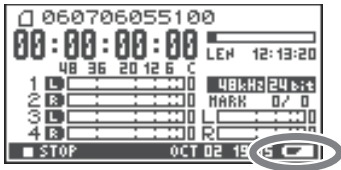
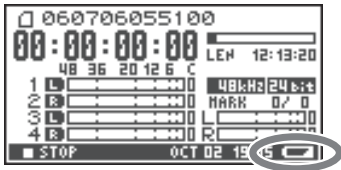
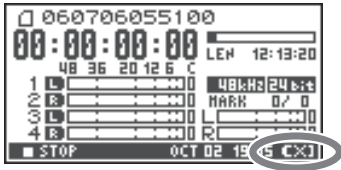
Remaining charge	Display
Level 4 (sufficient)	
Level 3	
Level 2	
Level 1	
Level 0 (little remaining)	

When the battery reaches Level 0, the message in the figure is shown. Replace the batteries as soon as possible.

If you continue using the R-44 when the batteries are low, the screen is the figure is shown, and then the power automatically turns off shortly thereafter.



Battery life

(When using alkaline batteries, 44.1 kHz, 16-bit, stereo, with phantom power off)

Continuous playback	approximately 4 hours
Continuous recording	approximately 4 hours

* The values for battery life shown above are only approximate; they will vary depending on your system and conditions of use.

* Battery life is shorter when the following settings are used. Illumination is on, button lights are bright, display is bright, phantom power is on, sampling frequency is high, 4-channel recording is used, or the internal speakers are used.

Using External Power Sources

When using an external power supply, be sure to set the final voltage.

The final voltage refers to the voltage when voltage can no longer be supplied because the capacity of the external power source is reduced and voltage decreases as electricity is consumed. If the final voltage is not properly set for the external power source, the remaining power display cannot be shown. Refer to the user's manual of the external power supply for the final voltage value.

Furthermore, when the "Battery Low" message is displayed, the recording automatically stops, and the power automatically turns off. Turn the R-44's power off and change the external power source.

* When using an external power source, even when power is automatically cut off, the R-44 starts within 30 seconds after power is turned back on. During this period, the final voltage settings can be changed.

* Read the following to set the final voltage for the R-44.

MEMO Refer to the user's manual for the external power source when using an external power source.

Setting the final voltage

- 1 Press the **[MENU]** button.
The display shows the System menu.



- 2 Use the **Cursor buttons [▲] [▼]** to select **5 System Set Up**, and press the **[ENTER]** button.
The System Setup screen is shown.



- 3 Use the **Cursor buttons [▲] [▼]** to select the **Ext-Power** item.



- 4 Use the **[SCRUB/VALUE]** dial to set the final voltage.

Final voltage values:

Adaptor/9.0/9.5/10.0/10.5/11.0/11.5/12.0 V

* The final voltage value will differ according to the external power source specifications. Check the specifications for the external power source being used for details.

* When the AC adaptor is used for power, set the final voltage (**Ext-Power**) to **Adaptor**.



- 5 Press the **[EXIT]** button twice to return to the Main screen.

This completes setting the final voltage.

Preparing the SD Memory Card

The R-44 uses an SD memory card.

The SD memory card is sold separately. Visit the Roland website (<http://www.roland.com>) before making a purchase. The website provides the most recent information regarding compatibility.

Inserting the SD Memory Card

- 1 Confirm that the power is turned off.
If the power is on, turn it off. Press and hold the **[POWER] switch** on the R-44 to turn power on or off.
- 2 Open the **Rubber flap** on the side of the unit.
- 3 Insert the memory card.
** When inserting the SD memory card, make sure the front of the card is facing up and insert the card slowly. If the card is forcibly inserted incorrectly, the R-44 or the SD memory card may be damaged. Please exercise caution.*
** Carefully insert the memory card all the way in until it is firmly in place.*
- 4 Close the **Rubber flap**.
- 5 Turn power on.
Press and hold down the **[POWER] switch** to turn on the power.

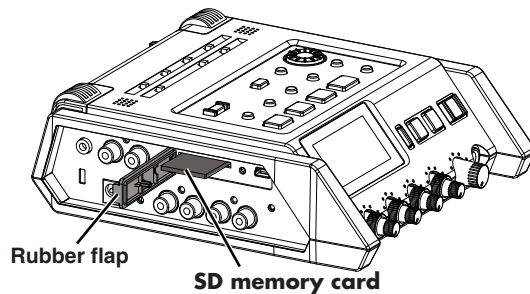

When using an SD memory card with the R-44 for the first time

When using an SD memory card with the R-44 for the first time, the memory card must be formatted. Please format the memory card following the procedure in **"Formatting and Checking the SD Memory Card"** (p. 66). "SD Unformatted" is shown when an unformatted memory card is inserted into the R-44.

The SD memory card write protect feature (LOCK)

The contents of the memory card can be protected by sliding the write protect switch on the side of the memory card to the "LOCK" position. Unlock the write protect switch to delete data on the card.

Write protect switch



Removing the SD Memory Card

- 1 Turn off power to the R-44.
- 2 Open the **Rubber flap**.
- 3 Lightly push the memory card inward, then release it.
Remove the memory card after it pops out toward you.
** Never insert or remove a memory card while this unit's power is on. Doing so may corrupt the data on the memory card.*

Recording

Recording from a Connected Microphone

The following describes how to record audio from a maximum of four microphones connected to the R-44's Combo input jacks.

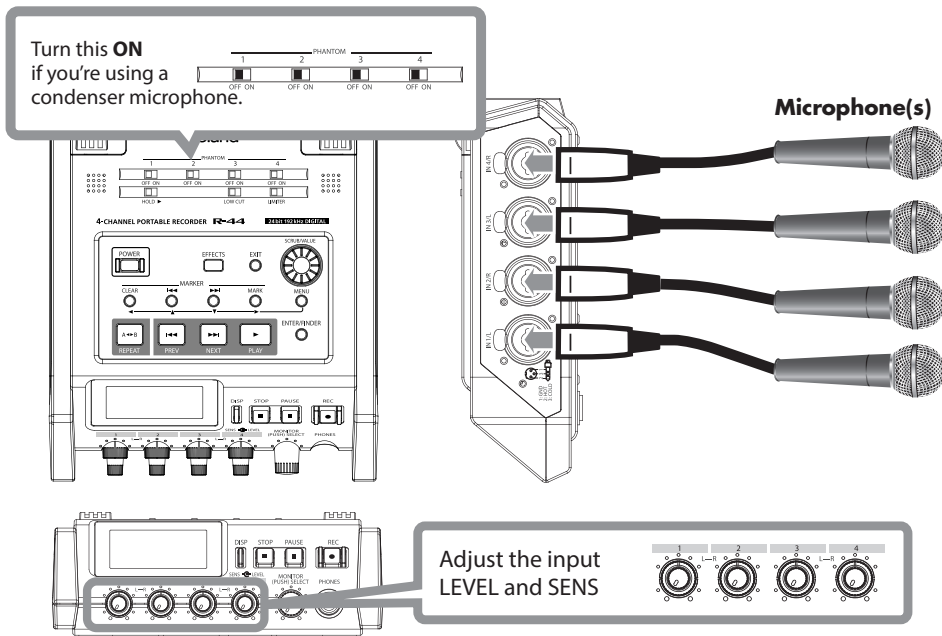

● Connections

Connect the microphone(s) to the **Combo input jack(s)**.

Acoustic feedback could be produced depending on the location of microphones relative to speakers. This can be remedied by:

1. Changing the orientation of the microphone(s).
2. Relocating microphone(s) at a greater distance from speakers.
3. Lowering volume levels.

● Phantom power switch

Turn this **ON** when connecting a phantom-powered condenser microphones.

● System settings

1. Press the **[MENU]** button.
2. In **1 Recording Setup**, set **Input Select** to **Analog**.
Set the other items in **1 Recording Setup** as appropriate for the recording you want to make.
3. When finished with the settings, press the **[EXIT]** button twice to return to the Main screen.

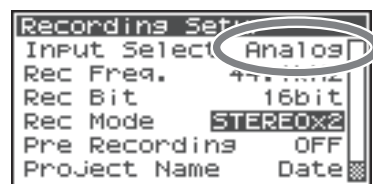

* For more about system settings, refer to "**System Setup**" (p. 62).

● Limiter

Turn this **ON** if you want to prevent unexpectedly loud sounds or strong attacks from producing clipping noise.

The limiter threshold is -10 dB relative to digital full scale.

The limiter can group and link each channel. Refer to **Limiter link** (p. 70).

● Low cut

You can turn low cut **ON** when breathing noise (the sound of breathing while recording a voice) or wind noise (when recording outside) may be a problem.

The low cut feature records while cutting the lower range of the input signal.

● Input level knobs

These knobs adjust sensitivity /input levels.

When recording in **STEREOx2**, these knobs control the following signals.

Channel 1	STEREO 1 L-channel	SENS/INPUT LEVEL 1 knob
Channel 2	STEREO 1 R-channel	SENS/INPUT LEVEL 2 knob
Channel 3	STEREO 2 L-channel	SENS/INPUT LEVEL 3 knob
Channel 4	STEREO 2 R-channel	SENS/INPUT LEVEL 4 knob

Adjusting the input levels

1. Turn the **Input level knob [SENS]** (outer) all the way left.
2. Turn the **Input level knob [LEVEL]** (inner) to the center position. This position is 0 dB.
3. Hold down the **[PAUSE]** button and press the **[REC]** button.
The R-44 enters recording standby mode. During recording standby, the [REC] button blinks and the indication alternates between **REC** and **STANDBY**.
4. Play the sound to be recorded into the microphone.
Gradually turn the **Input level knob [SENS]** toward the right.
Sensitivity has 11 steps of +4, -2, -8, -14, -20, -26, -32, -38, -44, -50, and -56 dBu.
* When the channel name display reverses, the input level has reached the clipping level. Set the knob to the position just before the display reverses.
5. Adjust the **Input level knob [LEVEL]** so that the Level meter shown in the display reaches a point slightly before **C (clip level)**. If the recording level is too low, quiet sounds will not be recorded. If the recording level is too high, loud sounds will be distorted, producing a crackling noise in the recording.

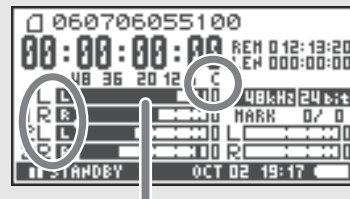

level meter (dBFS)

* When the channel name is blinking, clipping has occurred at the sensitivity adjustment stage. In this case, clipping occurs even if the Level meter does not reach the clip level.

* The Level meter displays the clip level (C) in values relative to 0 dBFS (FS = full scale). For example, **12** indicates -12 dBFS.

Automatically Detecting the Optimal Input level (Auto Sens)

Here's how to automatically detect the optimal input level for the audio that is currently being input, and display that value.

* The display will show the recommended setting at which the maximum level of the sound that was input during detection will be about -6 dBu.

1. Press the **[MENU]** button.
2. Use the **cursor buttons** [▲] [▼] to choose 6 Auto Sens, and press the **[ENTER]** button. Automatic detection will begin.

3. Into the mics, produce the sound that you intend to record.

* At least four seconds of detection is required after you press the **[ENTER]** button.

4. Press the **[STOP]** button to end automatic detection. The display will indicate each channel's recommended sensitivity level (SENS RECOMMEND) and the current setting (CURRENT).

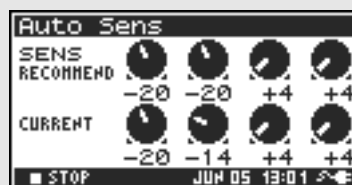

5. Use the **input level knobs [SENS] (outer ring)** to adjust the current value (CURRENT) so that it matches the recommended value (SENS RECOMMEND).

* If you press the **[EXIT]** button to end auto sense without adjusting the knobs, the settings will not be applied.

6. If you then press **[DISP]**, the display will show each channel's recommended level (LEVEL RECOMMEND) and the current value (CURRENT).

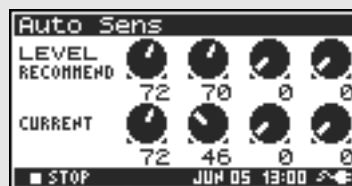

7. Use the **input level knobs [LEVEL] (inner ring)** to adjust the current value (CURRENT) so that it matches the recommended value (LEVEL RECOMMEND).

Difference between sensitivity and input level

Sensitivity and input level are differentiated in their use, as shown below.

Sensitivity	Adjusts to an appropriate volume according to the input signal strength.
Input Level	Adjusts the volume balance between the channels. Also, performs minute adjustments when adjusting cannot be done with sensitivity.

Noise can be controlled by adjusting sensitivity to the largest value without distortion.

● Record button [REC]

If you want to begin recording immediately, press the **[REC]** button.

Recording standby

If you want to put the R-44 in recording standby mode to be ready to record, hold down the **[PAUSE]** button and press the **[REC]** button.

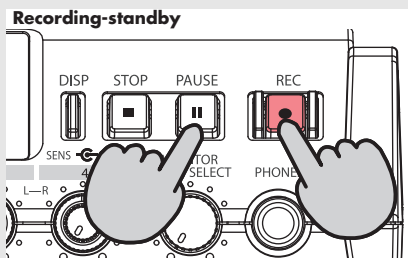

During recording standby, the **[REC]** button blinks and the indication alternates between **REC** and **STANDBY**.

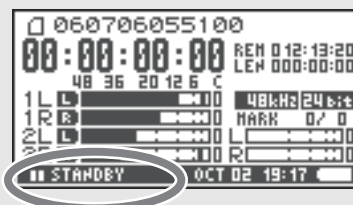

When recording is paused, the **[REC]** button blinks. In addition, the indication alternates between **REC** and **PAUSE**.

Press the **[REC]** or **[PAUSE]** button during recording standby or while paused to start recording.

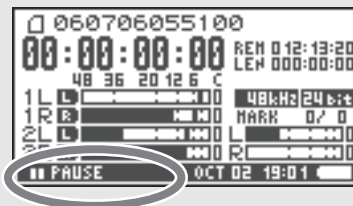

You can adjust input levels during recording standby.

● Other settings

If you want to monitor the sound being recorded, connect headphones to the **PHONES jack** and use the **Monitor level knob** to adjust the volume.

Adjusting the **Monitor level knob** does not affect the level of the sound actually being recorded.

To play the recorded sound, refer to **"Playing Back"** (p. 42).

Recording from the Internal Mics

The following describes how to record an audio source via the R-44's internal microphones.

● Phantom power switch

Turn this **OFF**.

● System settings

1. Press the **[MENU]** button.
2. In **1 Recording Setup**, set **Input Select** to **IntMic**.
Set the other items in **1 Recording Setup** as appropriate for the recording you want to make.
3. When finished with the settings, press the **[EXIT]** button twice to return to the Main screen.

* For more about system settings, refer to "**System Setup**" (p. 62).

* The limiter settings are invalid.

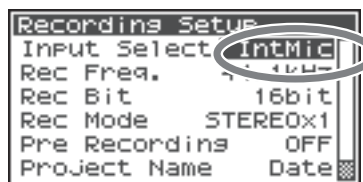

● Input level knobs

These knobs adjust the sensitivity and input levels.

Adjusting the input levels

1. Turn the **Input level knob [SENS]** (outer) all the way left.
2. Turn the **Input level knobs [LEVEL]** (inner) to the center position. This position is 0 dB.
3. Hold down the **[PAUSE]** button and press the **[REC]** button.
The R-44 enters recording standby mode. During recording standby, the **[REC]** button blinks and the indication alternates between REC and STANDBY.
4. Play the sound to be recorded into the microphone.
Gradually turn the **Input level knob [SENS]** 1 toward the right.
Sensitivity has 3 steps: Lo, Mid, and Hi.

* Sensitivity can be changed simultaneously for both MIC-L and -R with **Input Level knob 1**.

* When the channel name display reverses, the input level has reached the clipping level. Set the knob to the position just before the display reverses.

5. Gradually turn the **Input level knob [LEVEL]** toward the right.

* Input levels of the internal mics are adjusted by Input level knob 1 (MIC-L) and knob 2 (MIC-R).

6. Adjust the level so that the level meter shown in the display reaches a point slightly before **C (clip level)**.
If the recording level is too low, quiet sounds will not be recorded. If the recording level is too high, loud sounds will be distorted, producing a crackling noise in the recording.

* When the channel name is blinking, clipping has occurred at the sensitivity adjustment stage. In this case, clipping occurs even if the level meter does not reach the clip level.

* The level meter displays the clip level (C) in values relative to 0 dBFS (FS = full scale). For example, **12** indicates -12 dBFS.

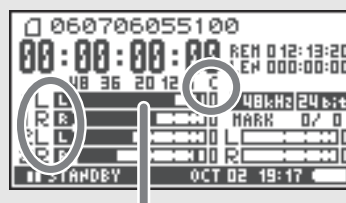

level meter (dBFS)

● Record button [REC]

Press the **[REC]** button to begin recording.

For details on recording standby, refer to "**Recording standby**" (p. 32).

● Other settings

If you want to monitor the sound being recorded, connect headphones to the **PHONES jack** and use the **Monitor level knob** to adjust the volume.

Adjusting the **Monitor level knob** does not affect the level of the sound actually being recorded.

To play the recorded sound, refer to "**Playing Back**" (p. 42).

Recording Digital Audio from a Digital Device

The following describes how to record from a digital device connected to the R-44's Digital input jack.

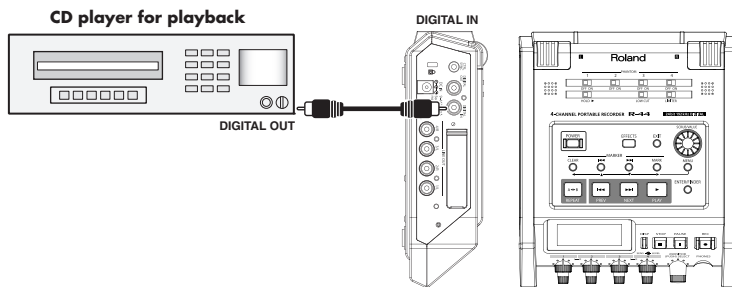

● Connections

Connect your digital device to the **Digital input jack**. You will need a separately available coaxial cable to connect your device to the R-44's **Digital input jack**.

● Phantom power switch

Turn this **OFF**.

● System settings

1. Press the **[MENU]** button.
2. In **1 Recording Setup**, set **Input Select** to **Digital**.
3. Set the sampling frequency to match the input source.
4. Set the other items in **1 Recording Setup** as appropriate for the recording you want to make.
5. When finished with the settings, press the **[EXIT]** button twice to return to the Main screen.

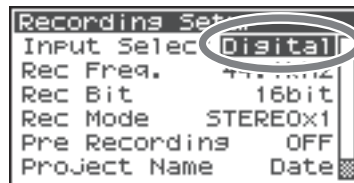

* For more about system settings, refer to **"System Setup"** (p. 62).

* Please set the sampling frequency to match the device being input.

* The R-44 is able to synchronize to the clock signal of the **Digital input jack**.

* When the input sampling frequency and set sample size differ, the sampling frequency display blinks and mute data is generated.

* When Sync Mode is set to Slave, digital input is disabled. Set Sync Mode to Master when recording from a digital device. Refer to **"5 System Setup"** (p. 71) in **"System Setup"** for settings.

● Record button [REC]

Press the **[REC]** button to begin recording.

For details on recording standby, refer to **"Recording standby"** (p. 32).

● Other settings

If you want to monitor the sound being recorded, connect headphones to the **PHONES jack** and use the **Monitor level knob** to adjust the volume.

Adjusting the **Monitor level knob** does not affect the level of the sound actually being recorded.

To play the recorded sound, refer to **"Playing Back"** (p. 42).

Simultaneously Recording Sound from Connected Microphones and a Digital Device

The following describes how to record sound from microphones connected to the R-44's Combo input jacks 3 and 4 and a digital device connected to the Digital input jack.

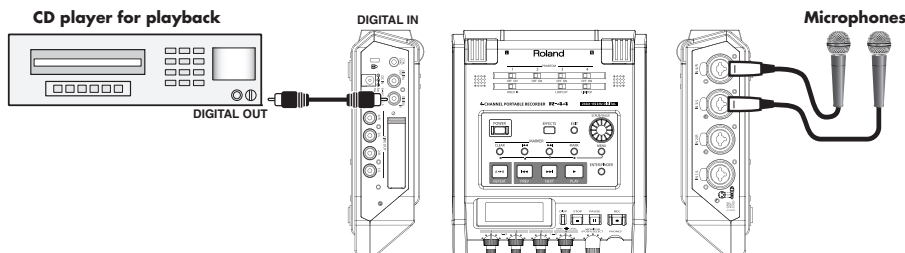

● Connections

Connect your microphones to **Combo input jacks 3 and 4**. Connect your digital device to the **Digital input jack**.

You will need a separately available coaxial cable to connect your device to the R-44's **Digital input jack**.

● Phantom power switch

Turn this **ON** when connecting a phantom-powered condenser microphones.

● System settings

1. Press the **[MENU]** button.
2. In **1 Recording Setup**, set **Input Select** to **Dig+Ana**.
3. Set the **Rec Mode** to **STEREOx2**.
Set the other items in **1 Recording Setup** as appropriate for the recording you want to make.
4. When finished with the settings, press the **[EXIT]** button twice to return to the Main screen.

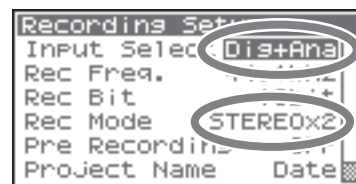

* If **Rec Freq** is set to **192 kHz** after setting **Dig+Ana**, **Input Select** is automatically changed to **Digital** and **Rec Mode** is changed to **STEREOx1**.

* Please set the sampling frequency to match the device being input.

* For more about system settings, refer to "**System Setup**" (p. 62).

● Limiter

Turn this **OFF** when recording an audio source whose levels have already been adjusted (in contrast to a live audio source whose levels might change unpredictably), or if you have already checked the maximum volume levels that are going to occur.

Turn this **ON** if you need to prevent clipping (distortion) caused by unexpected loud volumes or strong attacks.

● Low cut

You can turn low cut on when breathing noise (the sound of breathing while recording a voice) or wind noise (when recording outside) may be a problem.

The low cut feature records while cutting the lower range of the input signal.

* The **Limiter**, **Low cut** and **Input level knob [SENS]** settings are invalid for digital input.

● Input level knobs

These knobs adjust the input levels.

Use the following when simultaneously recording sound from microphones and a digital device.

Channel 1	Digital input L channel	The input level and sensitivity cannot be adjusted with the input level knob.
Channel 2	Digital input R channel	
Channel 3	Analog input L channel	Input level, SENS knob 3
Channel 4	Analog input R channel	Input level, SENS knob 4

Refer to **“Adjusting the input levels”** (p. 30).

● Record button [REC]

Press the **[REC] button** to begin recording.

For details on recording standby, refer to **“Recording standby”** (p. 32).

● Other settings

If you want to monitor the sound being recorded, connect headphones to the **PHONES jack** and use the **Monitor level knob** to adjust the volume.

Adjusting the **Monitor level knob** does not affect the level of the sound actually being recorded.

To play the recorded sound, refer to **“Playing Back”** (p. 42).

Simultaneously Recording Sound from Connected External Microphones and the Internal Mics

The following describes how to record sound from the microphones connected to the R-44's Combo input jacks 3 and 4 and the internal mics.

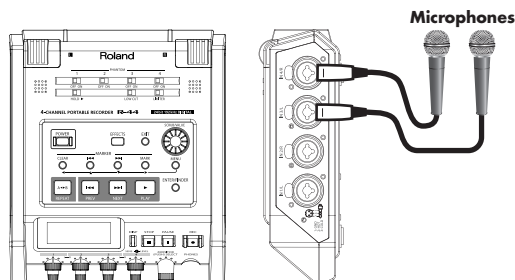

● Connections

Connect your microphones to **Combo input jacks 3 and 4**.

● Phantom power switch

Turn this **ON** when connecting phantom-powered condenser microphones.

● System settings

1. Press the **[MENU]** button.
2. In **1 Recording Setup**, set **Input Select** to **Int+Ana**.
3. Set the **Rec Mode** to **STEREOx2**.
Set the other items in **1 Recording Setup** as appropriate for the recording you want to make.
4. When finished with the settings, press the **[EXIT]** button twice to return to the Main screen.

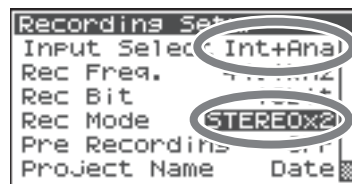

* If **Rec Freq** is set to **192 kHz** after setting **Int+Ana**, **Input Select** is automatically changed to **Digital** and **Rec Mode** is changed to **STEREOx1**.

* For more about system settings, refer to "**System Setup**" (p. 62).

● Limiter

Turn this **OFF** when recording an audio source whose levels have already been adjusted (in contrast to a live audio source whose levels might change unpredictably), or if you have already checked the maximum volume levels that are going to occur.

Turn this **ON** if you need to prevent clipping (distortion) caused by unexpected loud volumes or strong attacks.

● Low cut

You can turn low cut on when breathing noise (the sound of breathing while recording a voice) or wind noise (when recording outside) may be a problem.

The low cut feature records while cutting the lower range of the input signal.

● Input level knobs

These knobs adjust input levels.

Use the following when simultaneously recording sound from internal and external microphones.

Channel 1	Internal mic L channel	Input level, SENS knob 1
Channel 2	Internal mic R channel	
Channel 3	Analog input L channel	Input level, SENS knob 3
Channel 4	Analog input R channel	Input level, SENS knob 4

Refer to **Adjusting the input levels** (p. 30).

● Record button [REC]

Press the **[REC] button** to begin recording.

For details on recording standby, refer to **“Recording standby”** (p. 32).

● Other settings

If you want to monitor the sound being recorded, connect headphones to the **PHONES jack** and use the **Monitor level knob** to adjust the volume.

Adjusting the **Monitor level knob** does not affect the level of the sound actually being recorded.

To play the recorded sound, refer to **“Playing Back”** (p. 42).

Recording Digital Audio from an Analog Device

The following describes how to record from an analog device connected to the R-44's Combo input jacks.

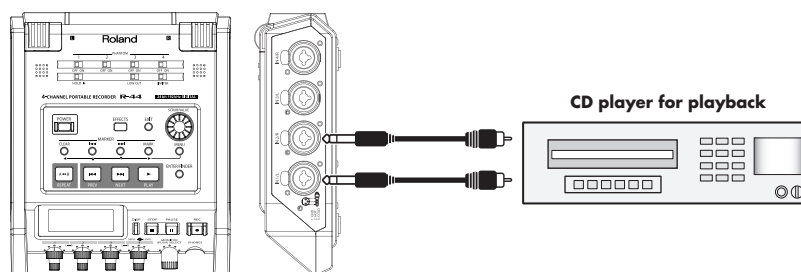

● Connections

Connect your analog device to the **Combo input jacks**. You will need a separately available audio cable to connect your device to the R-44's **Combo input jacks**.

● Phantom power switch

Turn this **OFF**.

● System settings

1. Press the **[MENU]** button.
2. In **1 Recording Setup**, set **Input Select** to **Analog**.
Set the other items in **1 Recording Setup** as appropriate for the recording you want to make.
3. When finished with the settings, press the **[EXIT]** button twice to return to the Main screen.

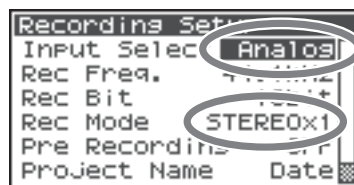

* For more about system settings, refer to "**System Setup**" (p. 62).

● Limiter

Turn this **ON** if you want to prevent unexpectedly loud sounds or strong attacks from producing clipping noise.

The limiter threshold is -10 dB relative to digital full scale.

The limiter can group and link each channel. Refer to "**Limiter link**" (p. 70).

● Input level knobs

Adjust the Input level 1 (L) and 2 (R) knobs. If there are channels to which you have not connected anything, turn their Input level knobs to the minimum position.

Refer to "**Adjusting the input levels**" (p. 30).

● Record button [REC]

Press the **[REC]** button to begin recording.

For details on recording standby, refer to "**Recording standby**" (p. 32).

● Other settings

If you want to monitor the sound being recorded, connect headphones to the **PHONES jack** and use the **Monitor level knob** to adjust the volume.

Adjusting the **Monitor level knob** does not affect the level of the sound actually being recorded.

To play the recorded sound, refer to "**Playing Back**" (p. 42).

Simultaneously Recording Sound from Connected Microphones and an Analog Device

The following describes how to record sound from microphones connected to the R-44's Combo input jacks 3 and 4 and an analog device connected to Combo input jacks 1 and 2.

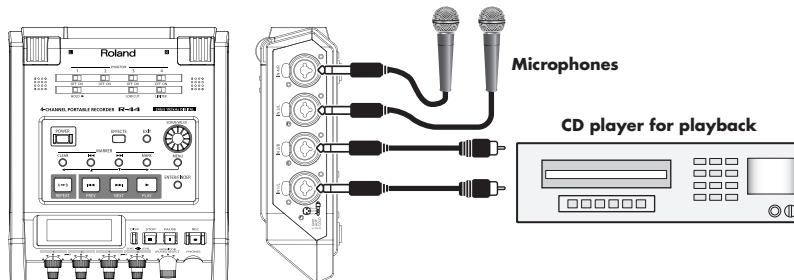

● Connections

Connect your microphones to **Combo input jacks** 3 and 4. Connect your analog device to the **Combo input jacks** 1 and 2.

You will need a separately available coaxial cable to connect your device to the R-44's **Combo input jacks**.

● Phantom power switch

Turn this **ON** when connecting a phantom-powered condenser microphones.

● System settings

1. Press the **[MENU]** button.
2. In **1 Recording Setup**, set **Input Select** to **Analog**.
3. Set the **Rec Mode** to **STEREOx2**.
Set the other items in **1 Recording Setup** as appropriate for the recording you want to make.
4. When finished with the settings, press the **[EXIT]** button to return to the Main screen.

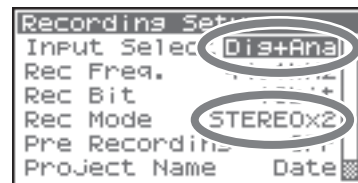

* For more about system settings, refer to **"System Setup"** (p. 62).

* If **Rec Freq** is set to **192 kHz** after setting **Rec Mode** to **STEREOx2**, **Input Select** is automatically changed to **Digital** and **Rec Mode** is changed to **STEREOx1**.

● Limiter

Turn this **ON** if you want to prevent unexpectedly loud sounds or strong attacks from producing clipping noise. The limiter threshold is -10 dB relative to digital full scale. The limiter can group and link each channel. Refer to **"Limiter link"** (p. 70).

● Low cut

You can turn low cut on when breathing noise (the sound of breathing while recording a voice) or wind noise (when recording outside) may be a problem. The low cut feature records while cutting the lower range of the input signal.

● Input level knobs

These knobs adjust input levels.

Use the following when simultaneously recording sound from microphones and an analog device.

Channel 1	Analog input L channel	Input level, SENS knob 1
Channel 2	Analog input R channel	Input level, SENS knob 2
Channel 3	Analog input L channel	Input level, SENS knob 3
Channel 4	Analog input R channel	Input level, SENS knob 4

Refer to **“Adjusting the input levels”** (p. 30).

● Record button [REC]

Press the **[REC] button** to begin recording.

For details on recording standby, refer to **“Recording standby”** (p. 32).

● Other settings

If you want to monitor the sound being recorded, connect headphones to the **PHONES jack** and use the **Monitor level knob** to adjust the volume.

Adjusting the **Monitor level knob** does not affect the level of the sound actually being recorded.

To play the recorded sound, refer to **“Playing Back”** (p. 42).

Playing Back

This section explains how to play audio recorded on the R-44 and projects on the R-44 SD memory Card. Make the correct settings and connections before playing anything back.

- **Connections Before Playback**..... (p. 42)
- **Setup Before Playback**..... (p. 44)
- **Playing Back** (p. 46)

Connections Before Playback

To prevent malfunction and/or damage to speakers or other devices, always turn down the volume, and turn off the power on all devices before making any connections.

Connecting Headphones

Headphones provide a convenient way to monitor while recording or to check sound immediately after recording.

1. Turn the **Monitor level knob** all the way to the left to minimize the volume.
2. Connect your headphones to the **PHONES jack**.
3. Slowly turn the **Monitor level knob** toward the right to adjust the volume.

Connecting Amplified Speakers

The following describes how to connect amplified speakers that have line input jacks or a digital input jack.

1. Turn off the power to the R-44.
2. Minimize the volume of the speakers you want to connect, and then turn off the power.
3. Depending on the type of speakers you are using, connect the amplified speakers to the **[LINE OUT] jacks** or **[DIGITAL OUT] jack**.
4. Turn on the R-44's power.
5. Turn on your speakers, and gradually increase the volume to the desired level.

Connecting a Mixer or Other Analog Device

The following describes how to connect a mixer or other audio device that has line input jacks to the output jacks of the R-44.

1. Turn off the power to the R-44.
2. Minimize the volume of the mixer or other device being connected.
3. Connect the mixer to the **[LINE OUT] jacks**.
You will need separately available audio cables (not included) to connect to the **[LINE OUT] jacks**.

* *Line output can be output as 4-indiv or monitor. Refer to "System Setting" in "5 System Setup" (p. 71) for details.*

4. Turn on the R-44's power.
5. Turn on your mixer, and gradually increase the volume to the desired level.

Connecting a Device Having a Digital Input Port

The following describes how to connect devices with digital input ports, such as mixers, speakers, or recording devices, to the **[DIGITAL OUT] jack** of R-44.

The sampling frequency of the project playing back will be the sampling frequency of the audio output from the digital output connector.

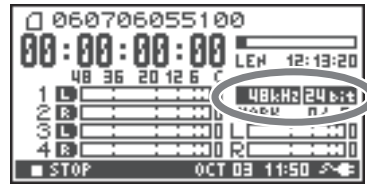

1. Turn off the power to the R-44.
2. Turn off power to the device with the digital input port.
3. Connect the **[DIGITAL OUT] jack** to the digital input connector of the device with digital input.
 - * You will need a separately available coaxial cable (not included) to connect your digital device to the **[DIGITAL OUT] jack**.
4. Turn on the R-44's power.
5. Turn on power to the device with the digital input port.
 - * You cannot adjust the volume of the digital signal on the R-44.

Setup Before Playback

Player Setup

- 1 Press the **[MENU]** button.
The System Menu screen appears on the display.



- 2 Use the **Cursor buttons** [▲] [▼] to choose **2 Player Setup**, and press the **[ENTER]** button.
The Player Setup screen appears.



- 3 Use the **[SCRUB/VALUE]** dial to choose the **Play Mode** value.
** The setting is applied as soon as you select it. You do not need to press the [ENTER] button.*



You can also setup the following items.

Menu	Player Setup settings	Playback method
Play Mode	Single	Selects the play mode. Only the selected project will play.
	Sequential	The projects in the folder containing the currently selected project will play consecutively.
Repeat	OFF , ON	Selects whether playback will repeat. If Play Mode is Single , only that project will be repeated. If it is Sequential , the projects in the folder containing the currently selected project play consecutively, and then the projects in the same folder will be repeated consecutively from the beginning.
Playlist	OFF , ON	Selects whether the Playlist function (p. 49) will be used. If the Playlist function is on, projects will play back in the order listed in the playlist.txt saved in the root folder of the SD memory card.

** The values in boldface are the default values.*

** For more about system settings, refer to "System Setup" (p. 62).*

Speaker Settings

You can use the R-44's Internal speakers to monitor the sound without having to connect headphones or other equipment.

- 1 Press the **[MENU]** button.
The System Menu screen appears on the display.



- 2 Use the **Cursor buttons [▲] [▼]** to choose **3 Speaker**, and press the **[ENTER]** button.
The Speaker screen appears.



Speaker Switch setting	Output destination
ON	Internal speakers Line output jacks Digital output jack Headphones
OFF	Line output jacks Digital output jack Headphones



* The value in boldface is the default value.

* Note that sound will not be output from the internal speakers if headphones are connected. If you want to use the internal speakers, you must disconnect the headphones.

* You cannot monitor with the internal speakers while recording. You will need to monitor through headphones.

* For more about system settings, refer to "**System Setup**" (p. 62).

Playing Back

Normal Playback

After performing the steps described in “Connections Before Playback” (p. 42) and “Setup Before Playback” (p. 44), proceed as follows.

- 1 Select the project that you want to play.
From the Main screen, press the **[ENTER/FINDER]** button.
- 2 In the Finder screen that appears, use the **Cursor buttons** [▲] [▼] or the **[SCRUB/VALUE]** dial to select a project. For more about the Finder screen, refer to “Manipulating a Project (Finder)” (p. 50).
- 3 Press the **[PLAY]** button.
The selected project will play.

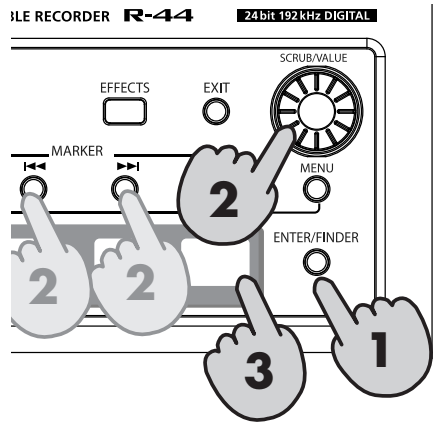

- 4 Slowly turn the **Monitor level knob** to the desired volume for listening.

- * Projects with names beginning with "." are ignored and are not shown.
- * If Japanese (double-byte) characters are used in the project name, it will not be displayed correctly. We recommend using file names that do not include Japanese (double-byte) characters so that they are easy to recognize.
- * Projects whose filename extension is not .pjt or .wav will be ignored and will not be shown.

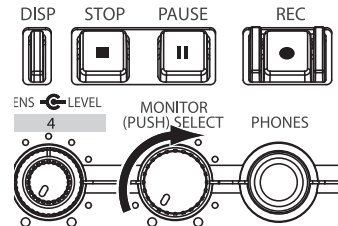

Markers

You can assign markers at desired locations in a project. Then you can use the **Maker [I◀◀] button** or **Maker [▶▶I] button** to move backward or forward to a marker location.

* You can use the Mark function only while playing (while the Main screen is displayed) or while recording.

- 1 Use the **[NEXT] button**, **[PREV] button** or the **[SCRUB/VALUE] dial** to find the location where you want to assign a marker.

Play, fast-forward (press and hold the **[NEXT] button**), or rewind (press and hold the **[PREV] button**) the project to the location where you want to assign a marker.

- 2 Press the **[MARK] button** at the location where you want to assign a marker.

The display indicates the number of markers, as shown in the figure at right. Markers are numbered sequentially starting from the beginning of the project.

You can assign up to 99 markers.

Repeat steps 1 and 2 to assign markers as desired.

* When the song ends, the number of passed markers becomes E.



- 3 After assigning one or more markers, proceed as follows.

You can use these operations either while playing or while stopped.

Maker [I◀◀] button

Moves to the marker immediately before the current location (previous marker).

Maker [▶▶I] button

Moves to the marker immediately following the current location (next marker).

[CLEAR] button

Deletes the markers that you set with the **[MARK] button**. Markers are deleted consecutively, starting with the marker immediately before the current location.

Repeat Playback (A-B REPEAT)

You can repeatedly play between two points (A-B) in a project. Simply assign points A and B during playback, and the playback will repeat between points A and B.

- 1 Play the project.
During playback, press the **[A-B REPEAT]** button once. The **[A-B REPEAT]** button blinks, and that location becomes the starting point (A) for repeat playback.

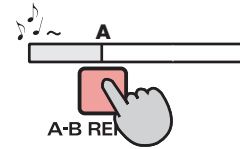

* If you press the **[STOP]** button after assigning point A but before assigning point B, point A will be deleted.

- 2 Press the **[A-B REPEAT]** button once again.
The **[A-B REPEAT]** button stays lit, and that location becomes the end point (B) for repeat playback.

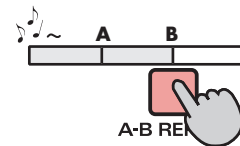

Playback automatically repeats between the points you specified in steps 1 and 2.

To cancel repeat playback, press the **[A-B REPEAT]** button after points A and B have already been assigned. The **[A-B REPEAT]** button goes out, and repeat playback is cancelled.

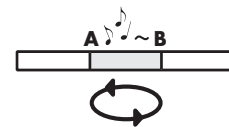

Please note

- * If you press the **[STOP]** button after assigning point A but before assigning point B, point A will be deleted.
- * If the song plays all the way to the end after assigning point A, playback will repeat between point A and the end of the song.
- * If you press the **[STOP]** button during repeat playback, playback stops and the repeat region (A-B) settings are cleared.

Specifying the Project Playback Order (Playlist Function)

You can make files play in the order of a playlist that you create using your computer.

- 1 Set the Play Mode to Sequential (p. 44).
- 2 Turn the Playlist function on (p. 44).
- 3 Press the **[PLAY]** button.

* While the Playlist function is on, the finder will show and play only the songs that are in the playlist. Even if the SD card contains songs that are not listed in the playlist, those songs cannot be viewed, selected, or played.

* If the Playlist function is on, the media indication in the finder will be "PLAY LIST."

* When you turn the Playlist function on, the currently selected folder will return to the root folder.

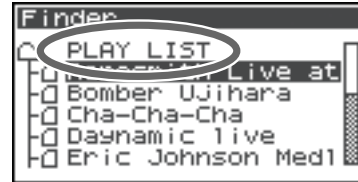

Creating a playlist

To create a playlist, use a text editor or similar program on your computer. The R-44 is not able to create playlists.

1. Using the format shown below, list the files in the order in which you want them to play.

```
scene1/scene1_001.PJT
scene5/scene5_003.PJT
scene3/scene3_002.PJT
reh_0524/reh_0524_001.WAV
reh_0524/reh_0524_001.WAV
:
:
```

* You must add the filename extension. This will be .WAV for an individual WAV file, and .PJT for an R-44 project file.

* Double-byte characters such as kanji are not supported for file names.

* Specify the file name as a full path from the root folder. For example if a folder named ABC contains a file CDE.WAV that you want to include in the playlist, "ABC/CDE.WAV" will be the path.

2. Save the text you created as a file named "playlist.txt" in the root folder of the SD memory card.

- Up to 100 files can be listed. Any files beyond this will be ignored.
- Uppercase and lowercase characters are not distinguished. ABC.WAV and abc.wav will specify the same file.
- If the play mode is "Sequential," an error will occur if the corresponding file is not found, and playback will stop. You can use the **[▶▶]** button to skip the song that produced the error and select the next song.
- If the list contains any non-playable files such as .DOC or .MP3, they will be ignored.
- Blank lines will be ignored.



Manipulating a Project (Finder)

The R-44 saves projects as files on an SD memory card. You can select a project from numerous folders or projects within folders to manipulate, i.e., to play, delete, or copy.

Finder functions

Menu	Operation	Page
Select	Select and load a project.	p. 50
Rename	Rename a project.	p. 51
Copy	Copy the selected project.	p. 52
Move	Move the selected project to a different folder.	p. 53
Delete	Delete a project.	p. 54
Make Folder	Create a new folder.	p. 55
Repair	Repair a project.	p. 56

Selecting a Project (Select)

- 1 Press the **[ENTER/FINDER]** button when a project is playing or stopped and the Main screen (p. 18) is shown on the display. The Finder screen shown in the figure is displayed.

Projects are shown in descending alphabetical order. SD represents the SD memory card.

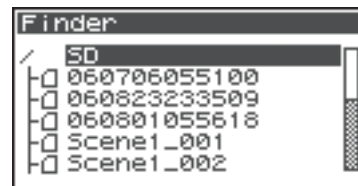

- 2 In the Finder screen, use the **Cursor buttons** [▲] [▼] or the **[SCRUB/VALUE]** dial to select the desired project. Then press the **[ENTER]** button.

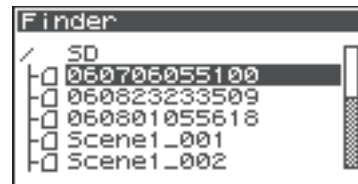

When a folder is selected, you can press the **Cursor button** [▶] to move into the selected folder (i.e., move to a lower-level folder).

If you want to move back to the upper-level folder, press the **Cursor button** [◀].

- 3 When the screen at right is displayed, use the **Cursor buttons** [▲] [▼] to select **1 Select**. Then press the **[ENTER]** button.

The project is selected, and you are returned to the Main screen.

Alternatively, with a project selected (step 2), you can press the **[PLAY]** button (instead of pressing the **[ENTER]** button) to play the selected project. You are returned to the Main screen when playback begins.

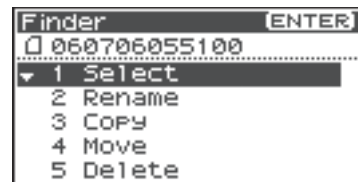

Renaming a Project (Rename)

- 1 Press the **[ENTER/FINDER]** button while the Main screen is shown in the display. The Finder screen shown in the figure is displayed.

Projects are shown in descending alphabetical order.

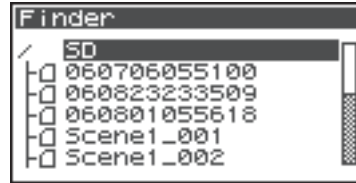

- 2 In the Finder screen, use the **Cursor buttons** [▲] [▼] or the **[SCRUB/VALUE]** dial to select the project you want to rename. Then press the **[ENTER]** button.

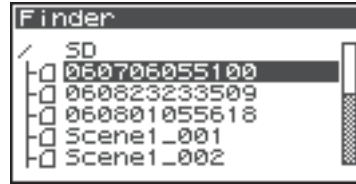

MEMO

When a folder is selected, you can press the **Cursor button** [▶] to move into the selected folder (i.e., move to a lower-level folder).

If you want to move back to the upper-level folder, press the **Cursor button** [◀].

- 3 When the screen shown in the figure is displayed, use the **Cursor buttons** [▲] [▼] to choose **2 Rename**. Then press the **[ENTER]** button.

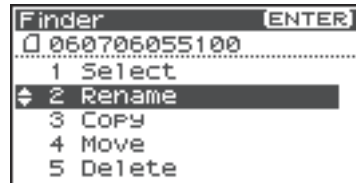

- 4 Use the **Cursor buttons** [◀] [▶] to move the cursor through the characters of the project name or folder name shown on the display. Place the cursor on the character that you want to change, and then use the **Cursor buttons** [▲] [▼] or the **[SCRUB/VALUE]** dial to change the character.



Use the **[PREV]** button to delete a character and the **[NEXT]** button to insert a character. Use these buttons to edit the name as desired.

When finished editing the name, press the **[ENTER]** button.

* If you decide to cancel without renaming, press the **[EXIT]** button before you press the **[ENTER]** button.

Do not turn off the power while a project is being renamed.

* When renaming a project, it cannot be given the name of an existing project. Doing so will produce an error.



Copying a Project (Copy)

- 1 Press the **[ENTER/FINDER]** button while the Main screen is shown in the display. The Finder screen shown in the figure is displayed.

Projects are shown in descending alphabetical order.

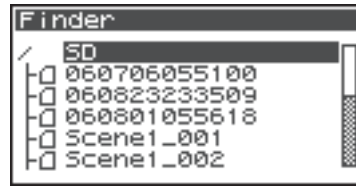

- 2 In the Finder screen, use the **Cursor buttons** [▲] [▼] or the **[SCRUB/VALUE] dial** to select the copy-source project (the project you want to copy). Then press the **[ENTER]** button.

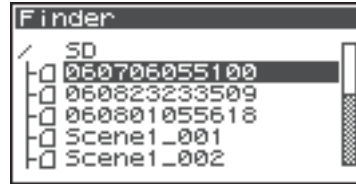

When a folder is selected, you can press the **Cursor button** [▶] to move into the selected folder (i.e., move to a lower-level folder).

If you want to move back to the upper-level folder, press the **Cursor button** [◀].

- 3 When the screen shown in the figure is displayed, use the **Cursor buttons** [▲] [▼] to select **3 Copy**. Then press the **[ENTER]** button.

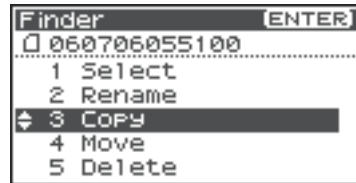

- 4 Use the **Cursor buttons** [▲] [▼] or the **[SCRUB/VALUE] dial** to select the copy-destination folder (the folder where you want to copy the project). Then press the **[ENTER]** button to execute the Copy operation. You can select folders or the root folder (SD) as the copy destination.

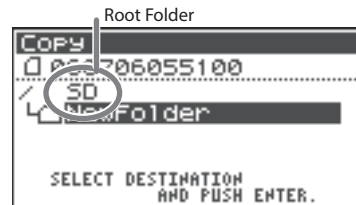

* If you decide to cancel without copying, press the **[EXIT]** button.

Do not turn off the power while a project is being copied.

* If the copy destination contains an identically named project, a number such as **-1** or **-2** is appended to the name of the copied project.



Moving a Project (Move)

- 1 Press the **[ENTER/FINDER]** button while the Main screen is shown in the display. The Finder screen shown in the figure is displayed.

Projects are shown in descending alphabetical order.

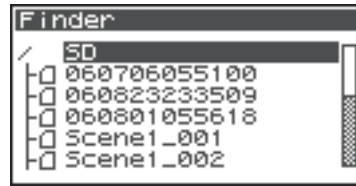

- 2 In the Finder screen, use the **Cursor buttons** [▲] [▼] or the **[SCRUB/VALUE]** dial to select the project that you want to move. Then press the **[ENTER]** button.

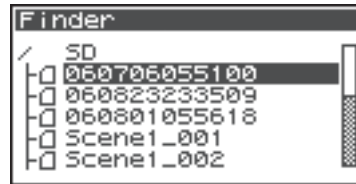

When a folder is selected, you can press the **Cursor button** [▶] to move into the selected folder (i.e., move to a lower-level folder).

If you want to move back to the upper-level folder, press the **Cursor button** [◀].

- 3 When the screen shown in the figure is displayed, use the **Cursor buttons** [▲] [▼] to select **4 Move**. Then press the **[ENTER]** button.

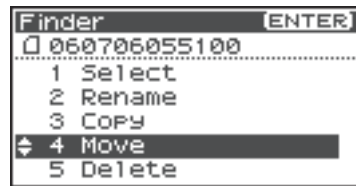

- 4 Use the **Cursor buttons** [▲] [▼] or the **[SCRUB/VALUE]** dial to select the destination folder (the folder where you want to move the project). Then press the **[ENTER]** button to execute the Move operation. You can also select the root folder (SD) as the destination.

* If you decide to cancel without moving, press the **[EXIT]** button.

Do not turn off the power while a project is being moved.

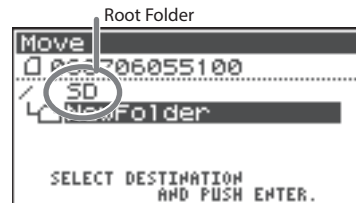

Deleting a Project (Delete)

- 1 Press the **[ENTER/FINDER] button** while the Main screen is shown in the display. The Finder screen shown in the figure is displayed.

Projects are shown in descending alphabetical order.

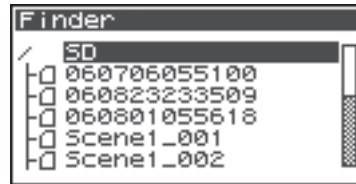

- 2 In the Finder screen, use the **Cursor buttons [▲] [▼]** or the **[SCRUB/VALUE] dial** to select the project you want to delete. Then press the **[ENTER] button**.

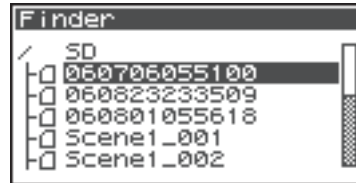

When a folder is selected, you can press the **Cursor button [▶]** to move into the selected folder (i.e., move to a lower-level folder).

If you want to move back to the upper-level folder, press the **Cursor button [◀]**.

- 3 When the screen shown in the figure is displayed, use the **Cursor buttons [▲] [▼]** to select **5 Delete**. Then press the **[ENTER] button**.

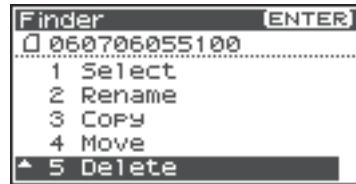

- 4 The screen shown in the figure is displayed. Press the **[ENTER] button** to execute the Delete operation.

* If you decide to cancel without executing, press the **[EXIT] button** before you press the **[ENTER] button**.

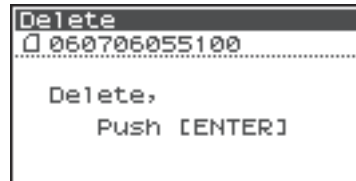

Do not turn off the power while a project is being deleted.



Creating a New Folder (Make Folder)

- 1 Press the **[ENTER/FINDER]** button while the Main screen is shown in the display. The Finder screen shown in the illustration will appear.

Projects are shown in descending alphabetical order.

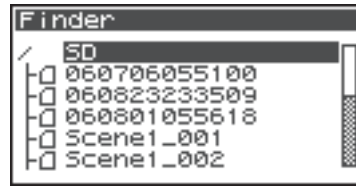

- 2 In the Finder screen, use the **Cursor buttons** [▲] [▼] or the **[SCRUB/VALUE]** dial to select **root folder (SD)** located at the top level.

Then press the **[ENTER]** button.

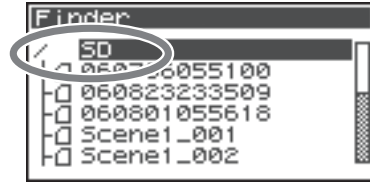

MEMO

When a folder is selected, you can press the **Cursor button** [▶] to move into the selected folder (i.e., move to a lower-level folder).

If you want to move back to the upper-level folder, press the **Cursor button** [◀].

- 3 When the screen shown in the figure is displayed, use the **Cursor buttons** [▲] [▼] to select **2 Make Folder**. Then press the **[ENTER]** button.

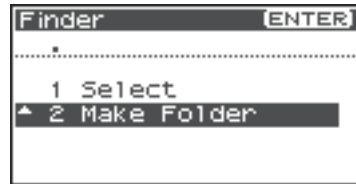

- 4 When the screen shown in the figure is displayed, press the **[ENTER]** button to confirm the operation.

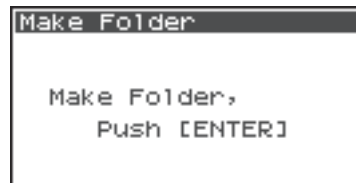

Do not turn off the power while a folder is being created.



- 5 A folder named NewFolder is created.

Projects are shown in alphabetical order, and folders are shown in alphabetical order after the projects.

Use the **Cursor buttons** [▲] [▼] or the **[SCRUB/VALUE]** dial to verify that the new folder was created.

If an identically named folder already exists, a number will be added to the name of the newly created folder, e.g., NewFolder-1, NewFolder-11, NewFolder-111, etc.

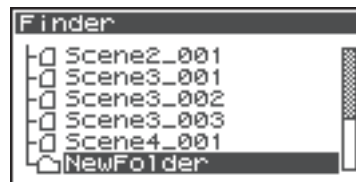

Repairing a Project (Repair)

This feature allows you to repair files that cannot be played because of an accident during recording, such as mistakenly disconnecting an AC adaptor or removing the SD memory card.

- 1 Press the **[ENTER/FINDER] button** while the Main screen is shown in the display. The Finder screen shown in the illustration will appear.

Projects are shown in descending alphabetical order.

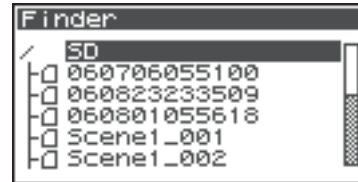

- 2 In the Finder screen, use the **Cursor buttons [▲][▼]** or the **[SCRUB/VALUE] dial** to select the project that you want to repair. Then press the **[ENTER] button**.

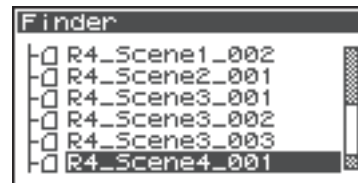

When a folder is selected, you can press the **Cursor button [▶]** to move into the selected folder (i.e., move to a lower-level folder).

If you want to move back to the upper-level folder, press the **Cursor button [◀]**.

- 3 When the screen shown in the figure is displayed, use the **Cursor buttons [▲][▼]** to select **6 Repair**. Then press the **[ENTER] button**.

* "6 Repair" is displayed only when the R-44 detects a damaged song.



- 4 When the screen shown in the figure is displayed, press the **[ENTER] button** to confirm the operation.

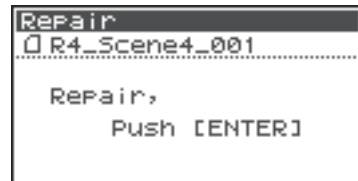

* Do not turn off the power or remove the SD memory card while a project is being repaired.

* This feature cannot repair all projects.



Setting the Color of Sound (Effects Settings)

The R-44 provides five types of effects. You can apply an effect to the incoming sound as it is being recorded, or you can apply an effect to the playback. You can also change the effect settings for each channel.

* *Effects are not available when the R-44 is operating at 192 kHz.*

Effect types provided on the R-44

No.	Effect name	Effect	Page
0	No Effect	No effects are applied. Use this setting if you want to preserve the effect on/off setting of each channel but do not want effects to be applied.	-
1	3-Band EQ	This effect is a three-band equalizer.	p. 60
2	Graphic EQ	You can adjust the gain of six fixed-frequency bands.	p. 60
3	Noise Gate	This effect minimizes the noise that might be heard in silent regions as well as low-frequency noise.	p. 60
4	Enhancer	By adding a phase-shifted sound to the direct sound, this effect sharpens the definition of the sound and pushes it toward the foreground.	p. 61
5	Comp&DeEsser	This effect cuts the sibilance that can be obtrusive in a vocal, making the sound smoother. It also reduces the difference between loud and soft sounds, making the level more consistent. The compressor evens out the level differences between loud and soft sounds. The de-esser reduces the unpleasant sibilance (exaggerated “s” sound) that is sometimes present in a vocal.	p. 61
6	MS-Mic	This effect converts sound recorded on an MS (Mid-Side type) microphone to stereo.	p. 61

If you apply an effect while recording, the volume and tone of the recorded sound will be different than the original sound.

Before applying an effect aggressively during recording, you should monitor the sound through headphones in recording standby mode to make sure that the sound is not clipped or distorted. We recommend that you make a test recording.

For details on the settings, refer to **“Applying Effects”** (p. 58).

When effects are operating, the Effect button lights.

? What is an effect?

On the R-44, an “effect” is a process that digitally transforms the sound, giving it greater clarity or impact. Effects can also make the sound more intelligible or reduce undesirable noise.

? What is clipping?

Applying an effect or boosting the level may increase the sound level (volume) beyond the maximum that a device can handle; this occurrence is called clipping. Loud sounds may be accompanied by distortion or crackly noises.

? What is an MS mic?

An MS mic creates stereo sound by combining sound from a main microphone (unidirectional) that records central sounds (mid-signal: M) and a bi-directional microphone that records lateral sounds (side signal: S).

Applying Effects

You can adjust the R-44's effects not only while in standby for recording or playback, but also while you are listening to the sound during actual playback or recording. This section explains how to adjust the effect settings during playback or in recording standby mode.

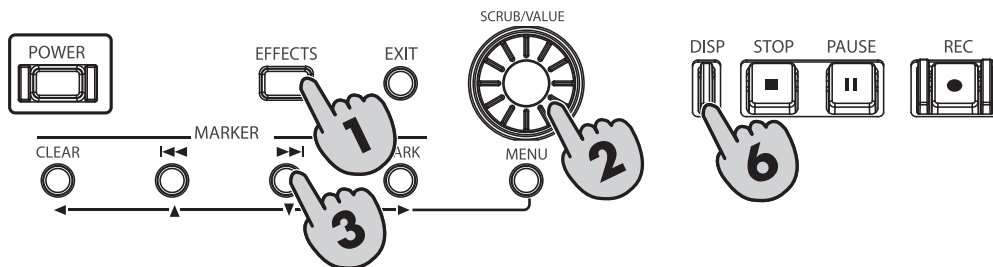

- 1 Press the **[EFFECTS]** button.

The Effects setup screen is shown on the display.

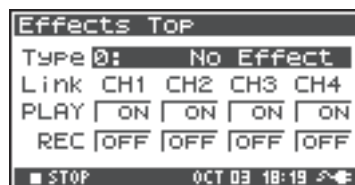

- 2 Use the **[SCRUB/VALUE]** dial to select the desired effect type.

For details on each effect type, refer to **"Effects"** (p. 60).

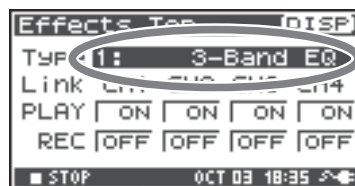

- 3 Press the **Cursor button [▼]**. The cursor will move to the "Link" field.

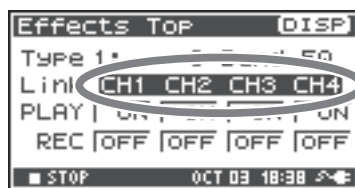

- 4 Use the **[SCRUB/VALUE]** dial to specify the channels to be linked.



CH1 CH2 CH3 CH4	The effect on/off setting and effect parameters are set independently for each channel.
CH1+2 CH3+4	The effect on/off setting and effect parameters are linked for channels 1 and 2 and for channels 3 and 4. Choose this setting if the project uses channels 1 and 2 and channels 3 and 4 as stereo pairs.
CH1+2+3+4	The effect on/off setting and effect parameters are linked for all channels.

- 5 In the same way, set the “PLAY” and “REC” fields.

PLAY

OFF	The effect is not applied during playback
ON	The effect is applied during playback

REC

OFF	The effect is not applied during recording
ON	The effect is applied during recording

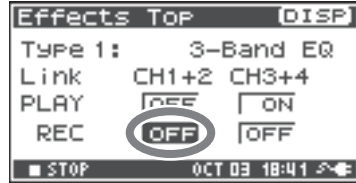
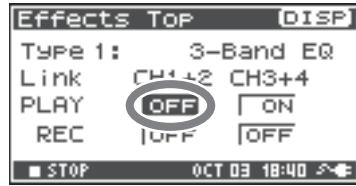

- 6 Press the **[DISP]** button.

The effect parameter screen is shown on the display.

* The effect parameter screen does not appear when 0: No Effect is selected as the type.

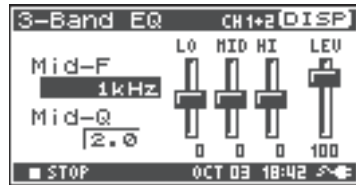

- 7 Use the **Cursor buttons** [▲] [▼] [◀] [▶] and the **[SCRUB/VALUE]** dial to set each effect parameter.

- 8 If you selected “CH1 CH2 CH3 CH4” or “CH1+2 CH3+4” in the “Link” field, press the **[DISP]** button.

The next channel (or pair of channels) will appear in the display.

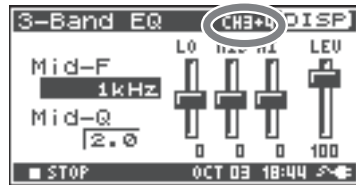

While selecting effects or setting effect parameters, you can return to the previous screen by pressing the **[EXIT]** button. The effect settings you make are stored until you change them. However, if you change the effect type (Type), the settings you made are reset to the default values.

- 9 When finished setting the effect parameters, press the **[EXIT]** button to return to the Main screen.

Each effect has various parameters that you can adjust to alter the character of the effect. The settings you make are stored even when the R-44's power is switched off. However, if you change the effect type, these settings are reset to the default values.

Effects

1: 3-Band EQ

No.	Parameter name	Range of values	Default values	Explanation
1	MID-F	200 Hz, 250 Hz, 315 Hz, 400 Hz, 500 Hz, 630 Hz, 800 Hz, 1 kHz, 1.25 Hz, 1.6 kHz, 2 kHz, 2.5 kHz, 3.15 kHz, 4 kHz, 5 kHz, 6.3 kHz	1 kHz	Specifies the center frequency of the mid-range equalizer.
2	MID-Q	0.5, 1.0, 2.0, 4.0, 8.0	2.0	Sets the range of the region centered on the Mid Freq for which the gain will change. Higher values narrow the region in which the change occurs.
3	LOW	-12 dB–0 dB–+12 dB	0 dB	Adjusts the gain of the low-range equalizer.
4	MID	-12 dB–0 dB–+12 dB	0 dB	Adjusts the gain of the mid-range equalizer.
5	HIGH	-12 dB–0 dB–+12 dB	0 dB	Adjusts the gain of the high-range equalizer.
6	LEVEL	0–120	100	Adjusts the overall volume.

2: Graphic EQ

No.	Parameter name	Range of values	Default values	Explanation
1	125 Hz	-12 dB–0 dB–+12 dB	0 dB	Adjusts the gain at 125 Hz.
2	250 Hz	-12 dB–0 dB–+12 dB	0 dB	Adjusts the gain at 250 Hz.
3	500 Hz	-12 dB–0 dB–+12 dB	0 dB	Adjusts the gain at 500 Hz.
4	1 kHz	-12 dB–0 dB–+12 dB	0 dB	Adjusts the gain at 1 kHz.
5	2 kHz	-12 dB–0 dB–+12 dB	0 dB	Adjusts the gain at 2 kHz.
6	4 kHz	-12 dB–0 dB–+12 dB	0 dB	Adjusts the gain at 4 kHz.
7	Level	0–120	100	Adjusts the overall volume.

3: Noise Gate

No.	Parameter name	Range of values	Default values	Explanation
1	LO-CUT	OFF, 40 Hz, 55 Hz, 63 Hz, 80 Hz, 100 Hz, 125 Hz, 160 Hz, 200 Hz, 250 Hz, 315 Hz, 400 Hz, 500 Hz, 630 Hz, 800 Hz, 1 kHz	100 Hz	Cuts unwanted low-frequency noise such as wind.
2	THRESHOLD	OFF, 1–100	20	Specifies the volume threshold below which the sound will be cut.
3	LEVEL	0–120	100	Adjusts the overall volume.

4: Enhancer

No.	Parameter name	Range of values	Default values	Explanation
1	SENSE	0–100	50	Adjusts the sensitivity of the enhancer effect.
2	MIX	0–100	50	Adjusts the amount of phase-shifted sound that is to be mixed with the input.
3	LEVEL	0–120	100	Adjusts the overall volume.

5: Comp&DeEsser

No.	Parameter name	Range of values	Default values	Explanation
1	DE-ESSER	OFF, ON	ON	Turn this ON to reduce unpleasant sibilance.
2	THRESHOLD	0–100	50	Sets the volume (threshold level) at which the compressor begins to operate. Compression is applied to the input when it exceeds this level. Lower threshold settings mean that the compressor is applied even at lower levels.
3	RATIO	1.0:1, 1.2:1, 1.5:1, 2.0:1, 2.8:1, 4.0:1, 8.0:1, 16.0:1, Inf:1	4.0:1	Adjusts the ratio at which the sound is compressed when the input exceeds the threshold level. Higher ratios mean that the sound is compressed more strongly.
4	ATTACK	6–100 ms	10 ms	Adjusts the time over which the amount of compression specified by Ratio is reached once compression is triggered when the input exceeds the threshold level. Higher Attack settings mean that compression is applied more slowly.
5	RELEASE	50–5000 ms	100 ms	Adjusts the time until compression is released once the input falls below the threshold level. Higher Release settings mean that the sound reverts to its uncompressed state more slowly.
6	GAIN	-6.0 dB–+18.0 dB (The value will change in steps of 0.5 dB)	0.0 dB	Adjusts the gain following compression.
7	LEVEL	0–120	100	Adjusts the overall volume.

6: MS-Mic

No.	Parameter name	Range of values	Default values	Explanation
1	Wide	0–100	80	Adjusts sound dispersion.
2	Level	0–120	100	Adjusts the overall volume.

* You can adjust the stereo dispersion during recording or playback. This case is limited to MS mics that can directly output the mid and side signals. Connect the mid-signal to CH1 (CH3) and the side signal to CH2 (CH4).

System Setup

You can make settings related to the R-44's system when performing initial settings for recording or playback. Press the **[MENU] button** to enter the system setup menu. Refer to **"Example Operations"** (p. 63) for setup procedures.

No.	Menu item	Summary	Page
1	Recording Setup	Allows you to make recording settings.	p. 63
2	Player Setup	Allows you to make playback settings.	p. 63
3	Speaker	Turns the speaker on/off.	p. 63
4	Display Setup	Allows you to make display settings.	p. 63
5	System Setup	Allows you to make settings to specify how the R-44 operates.	p. 63
6	Auto Sens	Automatically detect the optimal input level.	p. 31
7	Date & Time	Allows you to set the date and time of the R-44's internal calendar. You can specify the year, month, and date (day).	p. 64
8	Project Name	The R-44 automatically assigns a name to project files that are created when recording. You can set how this name will be assigned.	p. 65
9	SD Card	Allows you to format and check on the SD memory card.	p. 66
10	Factory Reset	Restores the R-44 to the factory default settings.	p. 67

Example Operations

Recording Setup

You can use the same procedure to make the settings listed below. As an example, we will show how to make **Recording Setup** settings.

- 1 Recording Setup
- 2 Player Setup
- 3 Speaker
- 4 Display Setup
- 5 System Setup

- 1 Press the **[MENU]** button.

The System Menu screen is shown on the display.



- 2 Use the **Cursor buttons** [▲] [▼] to choose **1 Recording Setup**, and press the **[ENTER]** button.

The Recording Setup screen is shown.

- 3 Use the **[SCRUB/VALUE]** dial to choose the **Input Select** value.

The setting is applied as soon as you select it. You do not need to press the **[ENTER]** button.

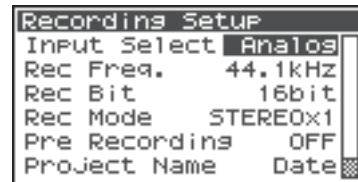

- 4 Use the **Cursor buttons** [▲] [▼] to select **Rec Freq.**

- 5 Use the **[SCRUB/VALUE]** dial to select the **Rec Freq.** value.

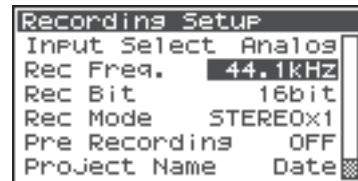

- 6 In the same way, use the **Cursor buttons** [▲] [▼] and the **[SCRUB/VALUE]** dial to select and set the remaining items.

- 7 When finished making settings, press the **[EXIT]** button.

You are returned to the System Menu screen.

- 8 Press the **[EXIT]** button again to return to the Main screen.

If you want to make other system settings, use the **Cursor buttons** [▲] [▼] to select the desired menu item.

Date & Time Settings

- 1 Press the **[MENU]** button.

The System Menu screen is shown on the display.



- 2 Use the **Cursor buttons [▲] [▼]** to select **7 Date & Time**, and press the **[ENTER]** button.

The Date & Time screen is shown.

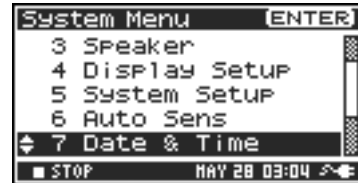

- 3 Use the **Cursor buttons [▲] [▼] [◀] [▶]** and the **[SCRUB/VALUE]** dial to set the date and time.

When finished making settings, press the **[EXIT]** button.
You are returned to the System Menu screen.

* *If you decide to cancel, press the [EXIT] button.*



- 4 Press the **[EXIT]** button again to return to the Main screen.

If you want to make other system related settings, use the **Cursor buttons [▲] [▼]** to select the desired menu item.

Project Name Settings

- 1 Press the **[MENU]** button.
The System Menu screen is shown on the display.



- 2 Use the **Cursor buttons** [▲] [▼] to select **8 Project Name**, and press the **[ENTER]** button.
The Project Name screen is shown.



- 3 Use the **Cursor buttons** [▲] [▼] to select the name you want to edit, and press the **[ENTER]** button.
A screen for editing the project name is shown.

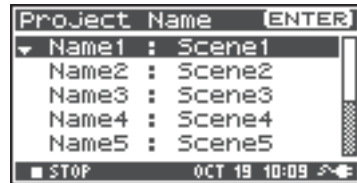

- 4 Use the **Cursor buttons** [▲] [▼] [▲] [▼], **[SCRUB/VALUE]** dial, **[PREV]** button, and **[NEXT]** button to edit the name.

When finished, press the **[ENTER]** button.
You are returned to the Project Name screen.

* If you decide to cancel, press the **[EXIT]** button.

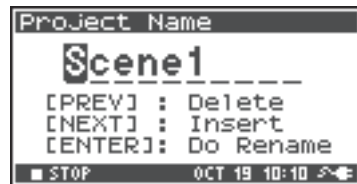

Available characters

(space) !#\$%&'()*+,-.0123456789;=@

ABCDEFGHIJKLMNOPQRSTUVWXYZ[]^_`abcdefghijklmnopqrstuvwxy{ }

- 5 Press the **[EXIT]** button again to return to the Main screen.

If you want to make other system related settings, use the **Cursor buttons** [▲] [▼] to select the desired menu item.

Formatting and Checking the SD Memory Card

- 1 Press the **[MENU] button**.
The System Menu screen is shown on the display.



- 2 Use the **Cursor buttons [▲] [▼]** to select **9 SD Card**, and press the **[ENTER] button**.
The SD Card Utility screen is shown.
** If you decide to cancel, press the [EXIT] button.*



- 3 Use the **Cursor buttons [▲] [▼]** to select either **"Format"** or **"Check,"** and press the **[ENTER] button**.
For details, refer to **"9 SD Card"** (p. 72).



- 4 The **"Are you sure?"** confirmation message appears. Use the **Cursor buttons [◀] [▶]** to select **"Yes"** if you are sure you want to execute or **"No"** if you decide to cancel without executing.
Then press the **[ENTER] button**.



The message shown at right is shown during processing.
Do not turn off the power during processing.



When processing has completed, you are automatically returned to the System Menu screen.

- 5 Press the **[EXIT] button** again to return to the Main screen.

If you want to make other system related settings, use the **Cursor buttons [▲] [▼]** to select the desired menu item.

** When first using an SD memory card with the R-44, be sure to format it with the R-44.*

Executing Factory Reset (Restoring Factory Default Settings)

- 1 Press the **[MENU]** button.
The System Menu screen is shown on the display.



- 2 Use the **Cursor buttons** [▲] [▼] to select **10 Factory Reset**, and press the **[ENTER]** button.
The Factory Reset screen is shown.



- 3 Press the **[ENTER]** button to perform Factory Reset.
** If you decide to cancel, press the **[EXIT]** button.*

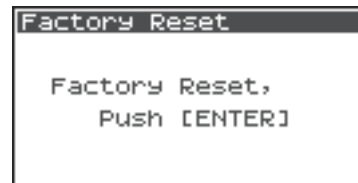

- 4 The "Are you sure?" confirmation message appears. Use the **Cursor buttons** [◀] [▶] to select "Yes" if you are sure you want to execute or "No" if you decide to cancel without executing.
Then press the **[ENTER]** button.

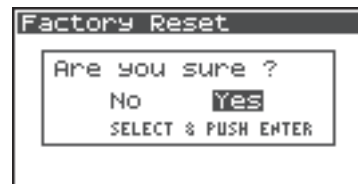

When processing has completed, you are automatically returned to the System Menu screen.

The message shown at right is shown during processing.
Do not turn off the power during processing.



- 5 Press the **[EXIT]** button again to return to the main screen.

If you want to make other system related settings, use the **Cursor buttons** [▲] [▼] to select the desired menu item.

System Menu

1 Recording Setup

The values in boldface are the default values.

* You cannot make Recording Setup settings during recording or playback.

* The R-44 is not able to convert previously recorded data to a different data format.

Menu item	Value	Function
Input Select	Analog	This selects the type of input. Choose this setting if you want to record analog input. Connect your microphones or analog audio device to the Combo input jacks. With this setting, any input from the internal mics or the Digital input jack is ignored.
	Digital	Choose this setting if you want to record digital input. The signal from a digital device connected to the Digital input jack is recorded. With this setting, any input from the internal mics or the Combo input jacks is ignored. The sampling frequency is specified by the Rec Freq. setting, and the bit depth by the Rec Bit setting.
	IntMic	Choose this setting if you want to record via the internal mics. Limiter and Low cut are disabled, and SENS has three levels.
	Dig + Ana	Choose this setting if you want to simultaneously record digital and analog input. The signal from the digital device connected to the Digital input jack and the signal from the microphones or analog audio device connected to the Combo input jacks are recorded simultaneously. For these settings, the digital input is on channels 1 and 2. Use channels 3 and 4 for the analog input.
	Int + Ana	Choose this setting if you want to simultaneously record from the internal mics and analog input. MIC-L is on channel 1, and MIC-R is on channel 2. Use channels 3 and 4 for the analog input. Limiter and Low cut are disabled, and SENS has three levels.
Rec Freq.	44.1 kHz , 48.0 kHz, 88.2 kHz, 96 kHz, 192 kHz	This sets the sampling frequency for recording. Higher sampling frequencies allow higher-quality recording but produce larger project files, meaning that there will be less available recording time on the SD memory card. The 44.1 kHz setting is sufficient when recording audio that falls within the normally audible range. This frequency is also the most suitable if you are going to load the recorded file into your computer to create a music CD. You can use the higher frequency settings when recording audio that contains a significant amount of high-frequency content from instruments such as cymbals or when you want to capture the brightness and transparency of a natural environment. <i>* When Rec Freq. is 192 kHz, only 2-channel recording is possible.</i>
Rec Bit	16 bit , 24 bit	This sets the sample size (bit depth) for recording. A larger sample size allows the sound to be captured in greater detail but produces a larger project file, meaning that there will be less available recording time on the SD memory card. Use the 16-bit setting for normal recording. This setting allows the broadest compatibility when loading the recorded file into your computer for playback. Use the 24-bit setting if you want to capture the tonal character and ambience in greater detail, such as when recording an instrumental or vocal performance. Depending on the PC environment, you may not be able to play project files recorded in 24 bit.

Menu item	Value	Function																																																	
Rec Mode	MONOx1	One-channel recording to one monaural file	<p>This selects the structure of the project file that is created during recording. A monaural WAV file will be created for each channel. Choose these settings if you are using a separate microphone for the vocal and performance or for each speaker in a conversation, so that a separate file is created for each channel. These settings create monaural WAV files. If Input Select is set to Analog, you can create up to four monaural files. If Input Select is set to IntMic or Digital, you can create up to two monaural files.</p> <p>* You cannot select MONO x3 or MONO x4 if Input Select is set to IntMic or Digital.</p> <p>* You cannot select MONO x3 or MONO x4 if Rec Freq. is set to 88.2 kHz, 96 kHz, or 192 kHz.</p>																																																
	MONOx2	Two-channel recording to two monaural files																																																	
	MONOx3	Three-channel recording to three monaural files																																																	
	MONOx4	Four-channel recording to four monaural files																																																	
	STEREOx1	Two-channel recording to one stereo file	<p>Two channels are recorded as L and R to create a stereo WAV file.</p> <p>If Input Select is set to Analog, one stereo WAV file with channel 1 as L and channel 2 as R is created. The inputs to channels 3 and 4 are ignored.</p> <p>If Input Select is set to IntMic or Digital, one stereo WAV file is created.</p>																																																
	STEREOx2	Four-channel recording to two stereo files	<p>If Input Select is set to Analog, a stereo file with channel 1 as L and channel 2 as R is created, and another stereo file with channel 3 as L and channel 4 as R is also created.</p> <p>* When Input Select is set to either IntMic or Digital or when Rec Freq. is set to 192 kHz, STEREOx2 cannot be selected.</p>																																																
4CHx1	Four-channel recording to one four-channel file	<p>Channels 1–4 will be recorded as a single WAV file. Be aware that not all computer software can handle four-channel WAV files.</p> <p>* When Input Select is set to either IntMic or Digital or when Rec Freq. is set to 192 kHz, 4CHx1 cannot be selected.</p>																																																	
<table border="1"> <thead> <tr> <th></th> <th>MONOx1</th> <th>MONOx2</th> <th>MONOx3</th> <th>MONOx4</th> <th>STEREOx1</th> <th>STEREOx2</th> <th>4CHx1</th> </tr> </thead> <tbody> <tr> <td>44.1 kHz</td> <td>○</td> <td>○</td> <td>○ *</td> <td>○ *</td> <td>○</td> <td>○ *</td> <td>○ *</td> </tr> <tr> <td>48 kHz</td> <td>○</td> <td>○</td> <td>○ *</td> <td>○ *</td> <td>○</td> <td>○ *</td> <td>○ *</td> </tr> <tr> <td>88.2 kHz</td> <td>○</td> <td>○</td> <td>×</td> <td>×</td> <td>○</td> <td>○ *</td> <td>○ *</td> </tr> <tr> <td>96 kHz</td> <td>○</td> <td>○</td> <td>×</td> <td>×</td> <td>○</td> <td>○ *</td> <td>○ *</td> </tr> <tr> <td>192 kHz</td> <td>○</td> <td>○</td> <td>×</td> <td>×</td> <td>○</td> <td>×</td> <td>×</td> </tr> </tbody> </table>					MONOx1	MONOx2	MONOx3	MONOx4	STEREOx1	STEREOx2	4CHx1	44.1 kHz	○	○	○ *	○ *	○	○ *	○ *	48 kHz	○	○	○ *	○ *	○	○ *	○ *	88.2 kHz	○	○	×	×	○	○ *	○ *	96 kHz	○	○	×	×	○	○ *	○ *	192 kHz	○	○	×	×	○	×	×
	MONOx1	MONOx2	MONOx3	MONOx4	STEREOx1	STEREOx2	4CHx1																																												
44.1 kHz	○	○	○ *	○ *	○	○ *	○ *																																												
48 kHz	○	○	○ *	○ *	○	○ *	○ *																																												
88.2 kHz	○	○	×	×	○	○ *	○ *																																												
96 kHz	○	○	×	×	○	○ *	○ *																																												
192 kHz	○	○	×	×	○	×	×																																												
<p>* Cannot be used if Input Select is set to IntMic or Digital.</p>																																																			

Menu item	Value	Function																																																				
Pre Recording	OFF, 1–47 sec	<p>You can specify the length of time that the sound is captured “retroactively,” starting from before the moment you pressed the [REC] button. This setting specifies the number of seconds that is captured retroactively.</p> <p>* The maximum time depends on the sampling frequency, the sample size (bit depth), and the mode setting.</p> <table border="1"> <thead> <tr> <th>Rec Freq.</th> <th>Rec Bit</th> <th>Rec Mode</th> <th>Pre Recording (Maximum Time)</th> </tr> </thead> <tbody> <tr> <td>44.1 kHz</td> <td>16</td> <td>MONO x1</td> <td>47</td> </tr> <tr> <td>44.1 kHz</td> <td>16</td> <td>STEREO x1</td> <td>23</td> </tr> <tr> <td>44.1 kHz</td> <td>16</td> <td>STEREO x2</td> <td>11</td> </tr> <tr> <td>48 kHz</td> <td>16</td> <td>STEREO x1</td> <td>21</td> </tr> <tr> <td>48 kHz</td> <td>16</td> <td>STEREO x2</td> <td>10</td> </tr> <tr> <td>48 kHz</td> <td>24</td> <td>STEREO x1</td> <td>14</td> </tr> <tr> <td>48 kHz</td> <td>24</td> <td>STEREO x2</td> <td>7</td> </tr> <tr> <td>88.2 kHz</td> <td>24</td> <td>STEREO x1</td> <td>7</td> </tr> <tr> <td>88.2 kHz</td> <td>24</td> <td>STEREO x2</td> <td>3</td> </tr> <tr> <td>96 kHz</td> <td>24</td> <td>STEREO x1</td> <td>7</td> </tr> <tr> <td>96 kHz</td> <td>24</td> <td>STEREO x2</td> <td>3</td> </tr> <tr> <td>192 kHz</td> <td>24</td> <td>STEREO x1</td> <td>3</td> </tr> </tbody> </table> <p>* “Pre Recording (Maximum Time)” is approximate.</p> <p>* The R-44 consumes power even during pre-recording. If you are running on batteries, you should pay attention to the remaining battery charge.</p>	Rec Freq.	Rec Bit	Rec Mode	Pre Recording (Maximum Time)	44.1 kHz	16	MONO x1	47	44.1 kHz	16	STEREO x1	23	44.1 kHz	16	STEREO x2	11	48 kHz	16	STEREO x1	21	48 kHz	16	STEREO x2	10	48 kHz	24	STEREO x1	14	48 kHz	24	STEREO x2	7	88.2 kHz	24	STEREO x1	7	88.2 kHz	24	STEREO x2	3	96 kHz	24	STEREO x1	7	96 kHz	24	STEREO x2	3	192 kHz	24	STEREO x1	3
		Rec Freq.	Rec Bit	Rec Mode	Pre Recording (Maximum Time)																																																	
44.1 kHz	16	MONO x1	47																																																			
44.1 kHz	16	STEREO x1	23																																																			
44.1 kHz	16	STEREO x2	11																																																			
48 kHz	16	STEREO x1	21																																																			
48 kHz	16	STEREO x2	10																																																			
48 kHz	24	STEREO x1	14																																																			
48 kHz	24	STEREO x2	7																																																			
88.2 kHz	24	STEREO x1	7																																																			
88.2 kHz	24	STEREO x2	3																																																			
96 kHz	24	STEREO x1	7																																																			
96 kHz	24	STEREO x2	3																																																			
192 kHz	24	STEREO x1	3																																																			
Project Name	Date, Name1–8	<p>This specifies how names are assigned to the recorded project files. You can select to base the name on the date and time or on the Project Name that you set. If you choose Date, a project recorded at 3:45 and 12 seconds in the morning, January 2, 2007, is given the name of “070102034512”.</p> <p>If you use the Date setting, the name of the project indicates the time that it was recorded; this is convenient when you have recorded a large number of projects and are looking for a specific one.</p> <p>If you choose Name, the project name is the name you set in “8 Project Name” (p. 72) plus an ascending serial number. If you specify a clearly identifiable project name, e.g., SCENE001, SCENE002, etc. the project files are grouped together.</p> <p>If you use the Name1–8 setting, the project name is the name you set in “8 Project Name” (p. 72) plus an ascending serial number. The serial number is incremented automatically, e.g., Scene1_001–Scene1_999, up to 999.</p> <p>The R-44 uses the number of the highest serial numbered project name in the current folder as the start value for the serial number.</p>																																																				
Limiter link	1/2/3/4	The limiter is applied independently to each channel.																																																				
	1+2/3+4	The limiter for channels 1 and 2 is linked. In addition, the limiter for channels 3 and 4 is linked.																																																				
	1+2+3+4	The limiter for all channels is linked.																																																				
	1+2/3/4	The limiter for channels 1 and 2 is linked. The limiter for channels 3 and 4 is applied independently.																																																				
	1/2/3+4	The limiter for channels 3 and 4 is linked. The limiter for channels 1 and 2 is applied independently.																																																				

2 Player Setup

Parameter	Value	Function
Play Mode	Single	This selects the playback mode. Only the selected project will play.
	Sequential	All projects in the folder containing the currently selected project are played sequentially.
Repeat	OFF, ON	This selects whether playback will repeat. If Play Mode is set to Single, only that project is played repeatedly. If Play Mode is set to Sequential, the projects in the folder containing the currently selected project play to the end of the list, and then the projects in that same folder play sequentially again from the beginning of the list.

Parameter	Value	Function
Playlist	OFF, ON	Selects whether the Playlist function (p. 49) will be used. If the Playlist function is on, projects will play back in the order listed in the playlist.txt saved in the root folder of the SD memory card.

3 Speaker

Parameter	Value	Function
Speaker Switch	OFF, ON	This switches the internal speakers on/off. <i>* Even if this is set to on, no sound is played from the internal speakers during recording standby or recording. The speakers also remain silent while headphones are being used.</i>

4 Display Setup

Parameter	Value	Function
Bright	1–5–10	This adjusts the display's contrast. Higher values emphasize the white areas of the display.
Display Timer	OFF , 2 sec, 5 sec, 10 sec, 20 sec	Sets the amount of time until the display becomes dark when no operations have been performed on the R-44. If you are operating the R-44 on battery power, use this setting to conserve battery life.
Button Light	Auto , Dim, Bright	Sets the button brightness. When set to Auto, the button light darkens linked to the set time of the Display Timer.
Illumination	OFF, ON	All buttons are dimly lit. Button positions are easily verified even in dark locations.

5 System Setup

Parameter	Value	Function
Auto Off	OFF, 10 min, 30 min, 240 min	Specifies the time after which the power will turn off if no operation has been performed. (Units: minutes)
Battery Type	Alkaline , Ni-MH	Sets the type of batteries you are using. Choose the Alkaline setting if you are using alkaline batteries or Ni-MH if you are using rechargeable nickel metal-hydride batteries. <i>* If you choose a setting that does not match the type of batteries that are actually installed, the remaining battery power indication will be incorrect.</i>
Ext-Power	Adaptor , 9.0/9.5/ 10.0/10.5/ 11.0/11.5/ 12.0V	Sets the final voltage when using an external power source. The "Battery Low!" message is displayed when the voltage of the external power source drops below the set voltage and if the voltage drops further, the power automatically turns off.
Output Sel	4-indiv monitor	Sets the sound output type (p. 18). The sound from each channel from LINE OUT is output without modification. Sound is output according to the output assignments
Sync Mode	Master Slave	Sets the sync signal mode (p. 75). These settings are for the transmission side. These settings are for the receiving side.
Project File	WAV, BWF	This specifies the desired format of the project files created during recording or editing. If you select WAV, a conventional WAV file will be created. If you select BWF, a BWF file containing information about the recording time and recording device (Roland R-44) will be created.

7 Date & Time

You can set the date and time.

If **Project Name** is set to **Date**, the time you specify here is used to set the date in the project name. This setting is also used for the date and time shown on the lower part of the display in the Main screen.

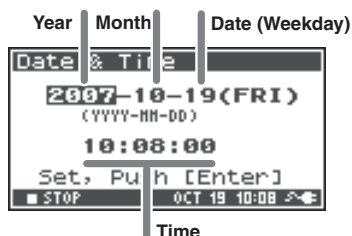

8 Project Name

You can use **Name 1–8** to specify eight different name types. The project name will consist of this name plus a consecutive number of 001, 002, 003, ... appended to it. For example, in the case of the default setting **Scene1**, the project name will be **Scene1_001**.

In order to use a name you have specified here, you will need to set the **Recording Setup** parameter **Project Name** to **Name 1–8**.

Available characters

(space) !#\$%&'()+,-.0123456789;=@

ABCDEFGHIJKLMNOPQRSTUVWXYZ[]^_`abcdefghijklmnopqrstuvwxyz{}

9 SD Card

You can format and check SD memory cards. You cannot execute “SD Card” commands during recording or playback.

Command	Explanation
Format	<p>Formats the SD memory card.</p> <p>All projects and folders in the SD memory card are erased; afterwards, the SD memory card is empty.</p> <p>* <i>Be sure to back up your projects before you execute this command.</i></p>
Check	<p>Checks the SD memory card, and after reorganization, frees up any SD memory card space not used by R-44 Projects.</p> <p>* <i>There is no guarantee that this command will restore the SD memory card to a normal operating state. Since this command directly manipulates the SD memory card sectors, projects may be damaged. Be sure to back up your projects before executing this command.</i></p>

10 Factory Reset

This command resets the following settings to their factory default settings. You cannot execute Factory Reset during recording or playback.

Recording Setup
Player Setup
Speaker
Display Setup
System Setup
Project Name
Effects (Type, Link, Play, Rec, Parameters)

Appendix

Connecting to a Computer

You can move or copy projects recorded on the R-44 to your computer. Likewise, you can move or copy files from your computer to the SD memory card.

Connecting the R-44 to Your Computer

Using battery power will not cause a malfunction, but we recommend that you always use the AC adaptor to prevent damage to the contents of the SD memory card, which could occur if the batteries fail while the R-44 is connected to your computer.

1 Turn on the **[POWER]** switch.

2 Use a USB cable to connect the R-44 to your computer.

The computer will detect the R-44, and the screen shown at right is shown.

It may take several seconds for detection to occur.

* If you see the **“Windows can perform the same action each time you insert a disk or connect a device with this kind of file.”** dialog box, click **[Cancel]**.

The computer will detect the R-44 as follows.



Windows 7 Windows Vista Windows XP Windows 2000	When viewed from My Computer or Explorer, the R-44 appears as R-44 .
Mac OS X	The R-44 appears as R-44 on the desktop.

* If you connect the R-44 to your computer when using an SD memory card that was not formatted by the R-44, the name **“R-44”** will not be displayed. You must use an SD memory card that was formatted by the R-44.

3 You can copy WAV files from the R-44 to your computer, or from your computer to the R-44.

To copy a file, drag and drop it.

* Depending on the computer environment, you may not be able to play project files recorded in 24 bit or 4ch.

Disconnecting the R-44 from a Computer

The following describes how to close the connection between your computer and the R-44. You must use the procedure described below to close the connection before you disconnect the USB cable.





Do not disconnect the USB cable or power down the R-44 while it is connected to your computer.

Windows 7, Windows Vista, Windows XP or Windows 2000

- 1 Close all software and windows (such as Explorer) that are referencing the SD memory card.
** If any software or windows (such as Explorer) referencing the SD memory card are open when you close the USB connection between your computer and the R-44, an error will occur and the connection will not be closed correctly.*
- 2 In the Windows task tray, double-click the **Safely Remove Hardware icon**.
The **Safely Remove Hardware** dialog box will appear.
- 3 Select the item (Roland R-44 USB Device) that indicates the R-44.
- 4 In the dialog box, click **[Stop]**.
- 5 When the **Stop a Hardware Device** dialog box appears, select the item that indicates the R-44, and click **[OK]**.
- 6 When your computer indicates “**Safe To Remove Hardware**,” you can disconnect the USB cable between the R-44 and your computer.
When you disconnect the cable, the screen shown at right will appear.
** Never switch off the R-44’s power or disconnect the USB cable before you have closed the connection. Doing so may damage the SD memory card.*



Mac OS X

- 1 Cancel the connection with the R-44 displayed on the desktop.
Drag the **R-44** icon to the  icon on the dock.
Normally, when you drag to the trash can located at the right edge of the dock, the indication changes from the trash can to  allowing you to cancel the connection.
- 2 When the icon has disappeared from the desktop, you can disconnect the USB cable between the R-44 and your computer.

Remotely Linking Two Connected R-44 Units

You can prepare two R-44 units and connect them with control sync to record with up to 8 channels.

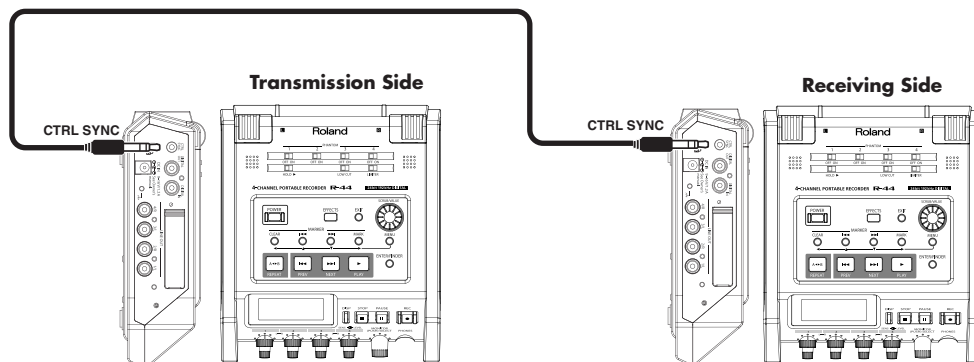

● Connections

Connect both R-44 units via the **Control sync connector**. A stereo mini cable is required to connect R-44 units via the R-44's **Control sync connector**. Please purchase separately.

● System settings

Transmission Side Setup

1. Press the **[MENU]** button.
2. In **5 System Setup**, set **Sync Mode** to **Master**.

* For more about system settings, refer to **"System Setup"** (p. 62).



Receiving Side Setup

1. Press the **[MENU]** button.
2. In **5 System Setup**, set **Sync Mode** to **Slave**.

* For more about system settings, refer to **"System Setup"** (p. 62).



This completes the settings for remote linking.

● Recording

Press the **[REC]** button on the transmitting R-44 to start the recording.

Refer to **"Recording"** (p. 29) for information about recording settings.

Recording standby can also be linked remotely.

Refer to **"Recording standby"** (p. 32) for information about recording standby.









* When using remotely linked recording, be sure that **Rec Freq.** in **Recording Setup** is the same for both R-44 units.

* Remote linking does not guarantee the exact same REC start time.

* The receiving R-44 cannot record from digital input.

Messages

This section explains the most important messages that may appear in the R-44's display

Message	Status
 Int-Batt Low!	Int-Batt Low! The remaining charge for the internal battery is low. The internal battery must be replaced. If the battery charge is insufficient, the internal clock will become inaccurate but you can record, play and manipulate the other functions correctly. Please contact one of the service locations listed on the warranty card to have the battery replaced.
 Battery Low!	Battery Low! The remaining charge for the batteries or the external power source is low. Install fresh batteries, change the external power source, or use the AC adaptor.
 SD buffering	SD buffering The recording buffer has almost reached capacity. Refer to p. 21 for details.
 SD Card Slow! PUSH ANY KEY	SD Card Slow! The recording buffer has reached capacity. Recording does not stop, but some sound is not recorded. This message will not disappear until a button is pressed. If this message is displayed again, it is possible that SD memory card processing capability has decreased. Format the SD memory card. Refer to p. 21 for details.
 SD unformatted	SD Unformatted This message is displayed if an SD memory card was formatted in a file format that the R-44 cannot read. Please format the SD memory card.
 SD Card Full!	SD Card Full! There is insufficient free space on the SD memory card. Transfer project files to your computer to free up more space.
 SD Card Locked	SD Card Locked The memory card is locked. Remove the memory card and unlock it.
 SD Card Error	SD Card Error An error occurred while accessing the memory card. The memory card may be corrupted.
 Over prj #999	Over prj #999 This message is displayed if you press the record button when a project name with a number of 999 already exists. You cannot record in this state. You need to change the project name before you can record.
 Project exists!	Project exists! An identically named project already exists. Create the project using a different name.
 File-Sys Error!	File-Sys Error! A problem has occurred with the file system.
 Name too long!	Name too long! The project name is too long. This message is displayed if the project name newly created when you copy a project is too long. You'll need to shorten the name of the source project.
 Improper Proj.	Improper Proj. The R-44 cannot handle this project.
 HOLD ON	HOLD ON The HOLD switch is on. This message is displayed if you attempt to operate the R-44 while the HOLD switch is on.
 Now Recording	Now Recording The R-44 is recording now. This message is displayed if you attempt to operate the R-44 during recording. If you need to perform an operation, you must first stop recording.
 Now Playing	Now Playing The R-44 is playing now. This message is displayed if you attempt to operate the R-44 during playback. If you need to perform an operation, you must first stop playback.

Troubleshooting

If you experience difficulties, read this section first. It contains tips on how to resolve various problems.

Problems with the Computer

Cannot close the connection with the R-44

When using Windows and if Explorer or any other software referencing the SD memory card is open when you attempt to close the USB connection between the R-44 and your computer, the error message “An error occurred while removing USB mass storage device – Unable to close device ‘unspecified volume.’ Please execute Stop Device again later.” will appear, and you will be unable to disconnect the R-44.

Close all software or windows that are referencing the SD memory card. Then execute “Safely Remove Hardware” (p. 74) once again.

Problems with Recording

Cannot record

You cannot record correctly if the input level specified with the **Input level knobs** is too low. Please set the input level correctly.

Refer to: “**Adjusting the input levels**” (p. 30)

When recording from connected microphones, make sure that the microphones are properly connected to the XLR input connectors.

Also check the setting of the **Phantom power switch**.

Refer to: “**Phantom Power Switches [PHANTOM POWER]**” (p. 10)

You cannot record correctly if the Input Select system setting is wrong.

Refer to: “**System Setup**” (p. 62)

Recorded audio is distorted

The audio is distorted if the input level is too high. Refer to “**Adjusting the input levels**” (p. 30), and use the **Input level knobs** to adjust the level appropriately.

In some cases, the sound may be distorted because an effect has been applied while recording. You should adjust the input level with the effect applied. Adjust the effect parameters so that distortion does not appear.

Pan (stereo image) is not stored correctly

If the limiter is turned on, it will respond to the levels of each channel, meaning that when the level of a sound located toward the right (or left) side increases, the limiter for that channel will limit the volume. If you're recording in stereo, the result will be that the left and right volume difference will diminish, causing the pan (stereo image) to move toward the center.

- Panning can be correctly recorded by linking the limiters of the channels being recorded in stereo using the Limiter Link.

Refer to: "1 Recording Setup" (p. 68)

If using the **Comp&DeEsser** effect with channel linking (LINK) set separately for CH1, CH2, CH3, and CH4, and the compressor begins to operate on CH1 (left), this will eliminate the level difference with CH2 (right), causing the pan (stereo image) to move toward the center.

- In this case, set the LINK setting to CH1+2 or CH3+4 so that whenever compression starts being applied to CH1 (left), it will be applied to CH2 (right) at the same time.

Refer to: "Setting the Color of Sound (Effects Settings)" (p. 57)

Also, the stereo image will not be recorded correctly if the input level knob settings differ significantly between L and R, so that the levels are not balanced correctly.

Even though the recording levels are set, the sound is distorted when an effect is turned on

Since some effects work by emphasizing a portion of the sound, this may increase the volume of the overall song, thereby causing clipping (distortion). You may take either of the following two actions.

- Lower the level (LEV) values for each effect parameter
The overall volume will decrease, but the character of the effect will be maintained.
Refer to: "Setting the Color of Sound (Effects Settings)" (p. 57)
- Lower the input level to decrease the volume before applying the effect
This adjustment is easy to make, but may change the resulting character of the effect.

The SD Card Slow! message is shown

- Writing access to the SD memory card has slowed down.
As you repeatedly write and delete project files, the files on the SD memory card become fragmented, and this slows down the processing speed.
If making important recordings, you should consistently delete all projects together when finished with them. Repeated deletion of smaller pieces of data causes the SD memory card to become fragmented, possibly causing recording to fail.
- The write speed for the SD memory card is specified to be slow.
The write speed may be slow depending on the model number of the SD memory card.
The Roland website provides the most recent information regarding operation. Please use only SD memory cards with model numbers for which operations have been confirmed.

Problems with Playback

No sound

- If the **Monitor level knob** is turned too far down, the volume may be too low for you to hear. Gradually increase the **Monitor level knob**.
Refer to: “**Monitor Level Knob [MONITOR (PUSH) SELECT]**” (p. 13)
- If the output assignments are not set appropriately, sound is not output.
Refer to: “**Output assignments**” (p. 18)
- Make sure that your headphones or speakers are connected correctly.

No sound from the Internal speakers

- In the system settings for Speaker (p. 71), make sure that Speaker Switch is ON. No sound is output from the Internal speakers if this setting is OFF.
- No sound is output from the Internal speakers if headphones are connected.
- To prevent acoustic feedback, no sound is output from the Internal speakers during recording or recording standby.
- When the sound is too loud, the protection circuit is activated and sounds stop. Turn the **Monitor level knob** to the left to adjust the volume to an appropriate level.

Skips occur in the sound

As you repeatedly write and delete project files, the files on the SD memory card become fragmented, and this slows down the processing speed. If you continue recording in this state, the message “SD Card Slow!” is shown, and skips may occur in the recorded project. If making important recordings, you should consistently delete all projects together when finished with them. Repeated deletion of smaller pieces of data causes the SD memory card to become fragmented, possibly causing recording to fail.

Problems with R-44 Operation

Power does not turn on

- Make sure that the AC adaptor is correctly connected.
If using batteries, make sure that each battery is securely in place and in the correct orientation. It is also possible that the batteries have run down, so you should obtain a new set of batteries.
Refer to: “Connecting the AC Adaptor and Turning the Power On/Off” (p. 24)
“Installing Batteries and Turning on the Power” (p. 25)
- Make sure that the HOLD switch is turned off.
If power is turned on when the **Hold switch** is on, the display indicates “HOLD ON” and turns off power.
Refer to: “Hold Switch [HOLD]” (p. 10)

Finder operation is sluggish

If a folder contains a large number of files, operations are sluggish when you open the Finder, and the screen does not scroll easily.
Try moving projects in the folder to a different folder so that the folder contains fewer projects.

Display is dark

The Display Timer setting in Display Setup sets the display to go dark when the unit has not been operated for a while.
Refer to: “4 Display Setup” (p. 71)

Settings disappear

If effect settings or system settings you made have reverted to their original state, it is possible that you inadvertently reset the R-44 to its factory default settings.
Refer to: “Executing Factory Reset (Restoring Factory Default Settings)” (p. 67)

Effect parameters that you set have been initialized

Effect parameter values are stored as long as the effect type is not changed; they will return to the default values if the effect type is changed. If you have made detailed settings, you should make a note of those settings to use them again.
Refer to: “Setting the Color of Sound (Effects Settings)” (p. 57)

Cannot operate the panel

Make sure that the **HOLD switch** is turned off.
If the **HOLD switch** is on, the panel buttons and the [SCRUB/VALUE] dial are inoperable.
Refer to: “Hold Switch [HOLD]” (p. 10)

Project names and folder names in the Main screen or Finder are garbled

The characters that are not “Available characters” are not displayed properly. In addition, RENAME may not have been performed correctly.
Refer to: “Available characters” (p. 72)

Power turns off about 30 seconds after being turned on

The external power supply is depleted. Replace the external power supply with a new device or switch to the AC adaptor. When using the AC adaptor, set the final voltage (**Ext-Power**) to **Adaptor**.
Refer to: “Setting the final voltage” (p. 27)

Main Specifications

Recorder Section

● Channels

4

● Data Type

Format: WAV/BWF

● Sampling Bit Rate

16/24 bit

● Sampling Frequency

44.1 kHz/48 kHz/88.2 kHz/96 kHz/192 kHz
(Limited to 2 channels for 192 kHz)

* 16 or 24-bit sampling size can be selected with any frequency.

● Recording Media

SDHC memory card (compatible with 64 MB –32 GB)

● Recording Time

Using 8 GB SDHC card (minutes)

16 bit/44.1 kHz stereo	755 minutes
16 bit/48 kHz stereo	694 minutes
24 bit/48 kHz stereo	462 minutes
24 bit/96 kHz stereo	231 minutes
24 bit/192 kHz stereo	115 minutes
16 bit/44.1 kHz 4 ch	377 minutes
:	:
16 bit/48 kHz 4 ch	347 minutes
24 bit/48 kHz 4 ch	231 minutes
24 bit/96 kHz 4 ch	115 minutes

* Recording times are approximate. Actual results may vary.

* If more than one recorded file exists, the total recordable time will be less than listed.

* Files up to 2 GB in size can be handled. If the file size reaches 2 GB during recording, the file is closed, a new file is created, and recording continues.

Input and Output

● Analog Input

Ch 1–4: XLR/TRS Combo type
XLR type (phantom powered)
TRS phone type (balanced/unbalanced)
Stereo Built-in Microphones

● Analog Output

Ch 1–4: RCA phono type (line output)
Headphone: Stereo Phone type (1/4 inch)

● Digital In/Out

RCA phono type (IEC 60958-3 compliant)

● Input Impedance

XLR: 4 k ohms or greater (balanced)
TRS: 6 k ohms or greater (balanced)

● Nominal Input Level

11 steps: +4, -2, -8, -14, -20, -26, -32, -38, -44, -50, -56
(Input Level Knob: Center)
Input Level Knob: negative infinity to +8 dBu

● Maximum Input

+24 dBu (Input Sens Knob: +4 dBu)

● Output Impedance

Line Output: 600 ohms

● Recommended Load Impedance

Line: 4 k ohms or greater
Headphone: 16 ohms or greater

● Output Level

Line output: -20 dBu (fixed)
Headphone: 40 mW + 40 mW

● Total Harmonic Distortion + Noise

Line output: 0.02 % (Input Sens: +4 dBu)

● Noise Level

Line Output: -100 dBu
(Input Sens: +4 dBu, Input Level: Center)

● Residual Noise Level

Line Output: -103 dBu
(Input Sens: +4 dBu, Input Level: Minimum)

● Frequency Response

20 Hz–40 kHz (0/-3 dB)

● Dynamic Range

AD: 100 dB
DA: 104 dB

● Phantom Power

48 V +/- 4 V
8 mA per 1 channel (20 mA or less for all channels)

Other Terminals

● USB Connector

Mini-B Type Connector
USB 1.1 or 2.0 High Speed (Mass Storage Class)

● Control Sync Jack

Stereo Mini Type
Word clock sync and start/stop remote control of 2 units

* Remote control function does not guarantee the exact same REC start time.

Built-In Effects

- 3-Band EQ
- 6-Band Graphic EQ
- Noise Gate
- Enhancer
- Comp & DeEsser
- MS Mic Mixing

* Effects can be during recording and playback.

* Effects are not available while sample rate is set to 192 kHz.

Controls

- Power Switch
- Hold Switch
- Input Level Knobs (LEVEL/SENS)
- Monitor Level Knob
- Phantom Power Switches: CH1/2/ 3/4
- Limiter Switch
- Low Cut Switch
- Scrub Dual

- Transport Buttons: PREV (REW), NEXT (FWD), STOP, PLAY/PAUSE, REC
- Marker Buttons: CLEAR, **◀◀**, **▶▶**, MARK
- Effect Button
- Menu Button
- Display Button
- A-B Repeat Button

Others

● Display

128 x 64 organic EL

● Power Supply

AC adaptor
AA type battery x 4 (Alkaline or Rechargeable Ni-MH only)
Battery life

Continuous playback	approximately 4 hours
Continuous recording	approximately 4 hours

* When using alkaline batteries, 44.1 kHz, 16-bit, stereo, with phantom power off.

● Current Draw

1.2 A

● Dimension

157 mm (W) x 183 mm (D) x 61 mm (H)
6-3/16" (W) x 7-1/4" (D) x 2-7/16" (H)

● Weight

1.3 kg including batteries and SD memory card
2 lbs., 14 oz.

* 0 dBu = 0.775 Vrms

* In the interest of product improvement, the specifications and/or appearance of this unit are subject to change without prior notice.

Block Diagram

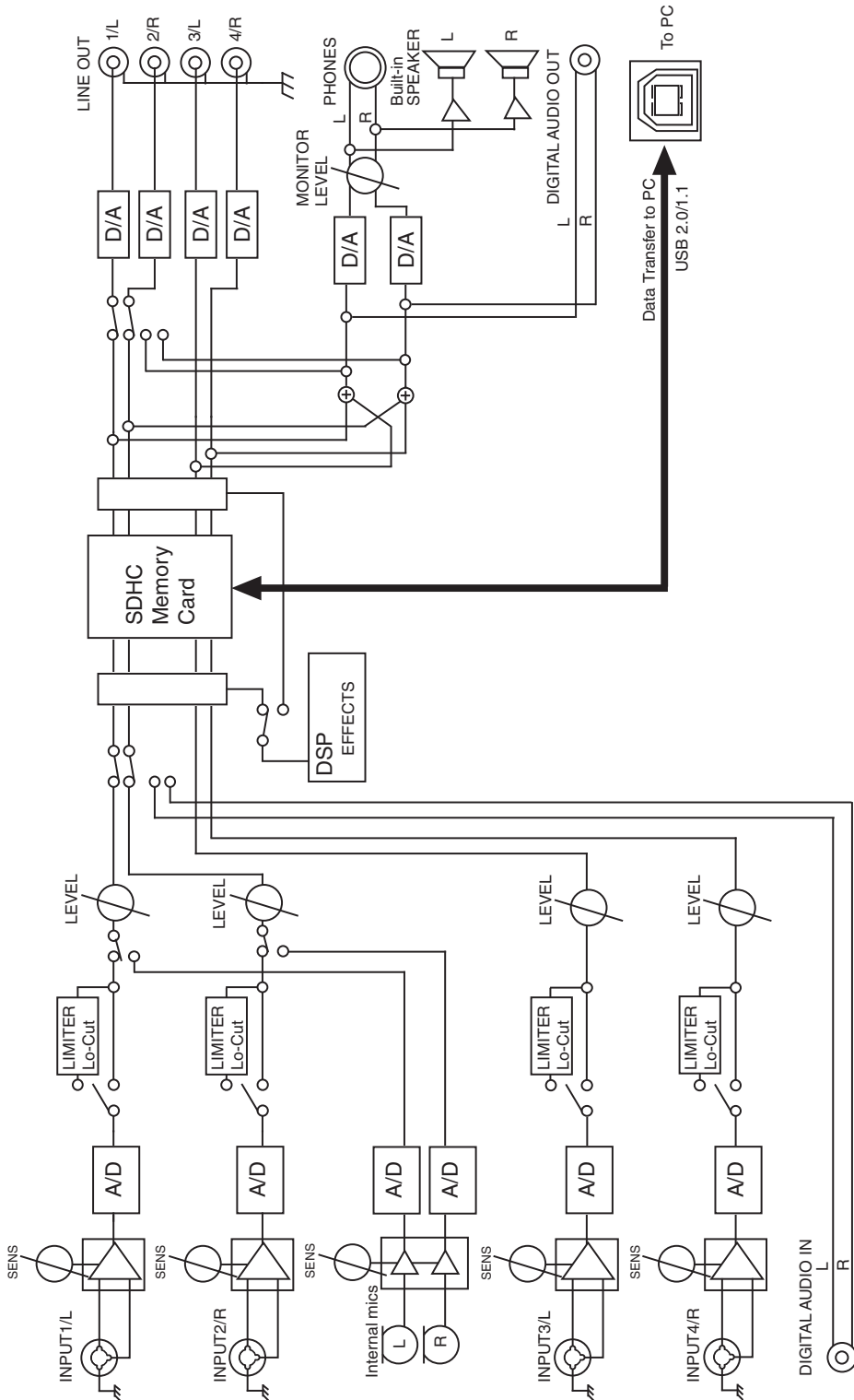

Index

Numerics

- 3-Band EQ 60
- 4CH 23
- 4-indiv 42, 71

A

- A-B REPEAT 11, 48
- A-B Repeat Button 11
- AC Adaptor 8, 24
- AC Adaptor Jack 14
- Adjusting the input levels 30
 - Int-Mic 33
 - LEVEL 30
 - SENS 30
- Alkaline 25, 71
- Amplified speakers 42
- Analog 68
- Analog device 42
- Auto Sens 31

B

- Batteries 25
- Battery Compartment 17
- Battery life 26
- Battery Low 76
- Battery Time 71
- Block diagram 83
- Bottom panel 17
- Bright 71
- BUF 21
- BWF 23

C

- Channel level meters 18
- Channel level sliders 19
- Channel names 18
- Check 72
- CLEAR 11
- Clear button 11
- Clip level indicators 18–19
- Combo Input Jacks 16
- Comp&DeEsser 61
- Computer 73
- Control Sync Connector 14, 75
- Copy 52
- CTRL SYNC 14
- Cursor Buttons 11

D

- Date 70
- Date & Time (Date and time) 19, 64, 72
- DC IN 14
- Delete 54
- Dig + Ana 68
- Digital 68
- Digital device 34
- DIGITAL IN 14
- Digital Input Jack 14
- DIGITAL OUT 14
- Digital Output Jack 14
- DISP 13
- Display 13, 18, 20
- Display Button 13
- Display Setup 71
- Display Timer 71

E

- Effect Button 11
- EFFECTS 11
- Effects 57–58
- Enhancer 61
- ENTER/FINDER 12
- Enter/Finder Button 12
- EXIT 11
- Exit Button 11
- Extension
 - pjt 22–23
 - wav 22–23
- External power sources 27
- Ext-Power 71

F

- Factory Reset 67, 72
- File size 23
- File-Sys Error 76
- Format 66, 72
- Four-channel projects 23
- Front panel 13

G

- Graphic EQ 60
- Grounding Terminal 15

H

- Headphone Jack 13
- Headphones 42

HOLD 10
 HOLD ON 76
 Hold Switch 10

I

Improper Proj. 76
 Input Level 31
 Input level knobs 13, 33, 36–37
 Input level select switch 36–37
 Input Select 68
 Int + Ana 68
 Int-Batt Low 76
 Internal Mics 9
 Internal Speakers 9
 Int-Mic 68

L

LEN 18
 LEVEL 13, 30–31
 Level scale 18
 LIMITER 10
 Limiter 29, 35, 37
 Limiter link 70
 Limiter Switch 10
 LINE OUT 15
 Line Output Jacks 15
 LOW CUT 10
 Low Cut Switch 10

M

Macintosh 74
 Main screen 18, 20
 Make Folder 55
 MARK 11, 47
 Mark button 11
 Marker Buttons 11
 Marker indicators 19
 MEMORY CARD SLOT 14
 MENU 11
 Menu Button 11
 MIC-L 9
 MIC-R 9
 Mixer screen 19
 Monaural projects 22
 monitor 42, 71
 MONITOR (PUSH) SELECT 13
 Monitor Level Knob 13
 MONOx1 22
 MONOx2 22
 MONOx3 22
 MONOx4 22

Move 53
 MS-Mic 61

N

Name 70, 76
 Name too long 76
 NEXT 12
 NEXT Button 12
 Ni-MH 71
 Noise Gate 60
 Now Playing 76
 Now Recording 76

O

Output assignments 18
 Output level meters 19
 Output Sel 71
 Over prj #999 76

P

PAUSE 13
 Pause Button 13
 PHANTOM POWER 10
 Phantom power switch 10, 29, 33–35, 37, 39–40
 PHONES 13
 pjt 22–23
 PLAY 12
 Play Button 12
 Play Mode 44, 70
 Player Setup 44, 70
 Playlist 44, 49, 71
 POWER 11, 24
 Power source 19
 Power Switch 11
 Pre Recording 70
 PREV 12
 PREV Button 12
 Progress bar 18
 Project exists 76
 Project Name 18, 65, 70, 72
 Projects 22

R

REC 13
 Rec Bit 68
 Rec Freq. 68
 Rec Mode 69
 Rechargeable nickel metal-hydride 25
 Record button 13, 32–34, 36, 38
 Recordable time 20
 Recording Setup 63

Index

Recording-standby	32	Windows	74
REM	19		
Remaining space on SD memory card	20		
Remaining time	19		
Rename	51		
Repair	56		
Repeat	44, 70		
Rubber Flap	14		
S			
Sample size	18		
Sampling frequency	18		
Scrub dial	11		
SCRUB/VALUE	11		
SD buffering	76		
SD Card	66, 72		
SD Card Error	76		
SD Card Full!	76		
SD Card Locked	76		
SD Card Slow!	76, 78		
SD Unformatted	76		
Security Slot	14		
Select	50		
SENS	13, 30–31		
Sensitivity	31		
Sequential	44, 70		
Side panel	14, 16		
Single	44, 70		
Speaker	45, 71		
Speaker Switch	45, 71		
Stereo	23		
Stereo projects	23		
STOP	13		
Stop Button	13		
System settings	29, 33–35, 37, 62		
System Setup	71		
T			
Time counter	18, 20		
Top panel	9		
Total recording time	20		
Total time	18		
U			
USB	14		
USB Cable	8		
USB connector	14		
W			
wav	22–23		
WAV file	22–23		

MEMO

MEMO

R-44 4-Channel Monitoring Chart

Format: MONOx4

Channel names	Output Assignment	Output Jack	Output Select (Type)	
			4-indiv	Monitor
1L	L	1/L	Mic 1	Mic 1+3
1R	R	2/R	Mic 2	Mic 2+4
2L	L	3/L	Mic 3	Mic 3
2R	R	4/R	Mic 4	Mic 4
		Headphone L	Mic 1+3	Mic 1+3
		Headphone R	Mic 2+4	Mic 2+4
1L	L	1/L	Mic 1	Mic 1
1R	R	2/R	Mic 2	Mic 2
2L		3/L	Mic 3	Mic 3
2R		4/R	Mic 4	Mic 4
		Headphone L	Mic 1	Mic 1
		Headphone R	Mic 2	Mic 2
1L		1/L	Mic 1	Mic 3
1R		2/R	Mic 2	Mic 4
2L	L	3/L	Mic 3	Mic 3
2R	R	4/R	Mic 4	Mic 4
		Headphone L	Mic 3	Mic 3
		Headphone R	Mic 4	Mic 4
1L	LR	1/L	Mic 1	Mic 1+3
1R	LR	2/R	Mic 2	Mic 2+4
2L	LR	3/L	Mic 3	Mic 3
2R	LR	4/R	Mic 4	Mic 4
		Headphone L	Mic 1+2+3+4	Mic 1+2+3+4
		Headphone R	Mic 1+2+3+4	Mic 1+2+3+4
1L	LR	1/L	Mic 1	Mic 1
1R		2/R	Mic 2	Mic 1
2L		3/L	Mic 3	Mic 3
2R		4/R	Mic 4	Mic 4
		Headphone L	Mic 1	Mic 1
		Headphone R	Mic 1	Mic 1
1L		1/L	Mic 1	Mic 1
1R	LR	2/R	Mic 2	Mic 2
2L		3/L	Mic 3	Mic 3
2R		4/R	Mic 4	Mic 4
		Headphone L	Mic 2	Mic 2
		Headphone R	Mic 2	Mic 2
1L		1/L	Mic 1	Mic 3
1R		2/R	Mic 2	Mic 3
2L	LR	3/L	Mic 3	Mic 3
2R		4/R	Mic 4	Mic 4
		Headphone L	Mic 3	Mic 3
		Headphone R	Mic 3	Mic 3
1L		1/L	Mic 1	Mic 4
1R		2/R	Mic 2	Mic 4
2L		3/L	Mic 3	Mic 3
2R	LR	4/R	Mic 4	Mic 4
		Headphone L	Mic 4	Mic 4
		Headphone R	Mic 4	Mic 4
1L		1/L	Mic 1	None
1R		2/R	Mic 2	None
2L		3/L	Mic 3	Mic 3
2R		4/R	Mic 4	Mic 4
		Headphone L	None	None
		Headphone R	None	None

Format: 4CHx1

Channel names	Output Assignment	Output Jack	Output Select (Type)	
			4-indiv	Monitor
1L	L	1/L	Mic 1	Mic 1+3
1R	R	2/R	Mic 2	Mic 2+4
2L	L	3/L	Mic 3	Mic 3
2R	R	4/R	Mic 4	Mic 4
		Headphone L	Mic 1+3	Mic 1+3
		Headphone R	Mic 2+4	Mic 2+4
1L	L	1/L	Mic 1	Mic 1
1R	R	2/R	Mic 2	Mic 2
2L		3/L	Mic 3	Mic 3
2R		4/R	Mic 4	Mic 4
		Headphone L	Mic 1	Mic 1
		Headphone R	Mic 2	Mic 2
1L		1/L	Mic 1	Mic 3
1R		2/R	Mic 2	Mic 4
2L	L	3/L	Mic 3	Mic 3
2R	R	4/R	Mic 4	Mic 4
		Headphone L	Mic 3	Mic 3
		Headphone R	Mic 4	Mic 4
1L	LR	1/L	Mic 1	Mic 1+2+3+4
1R	LR	2/R	Mic 2	Mic 1+2+3+4
2L	LR	3/L	Mic 3	Mic 3
2R	LR	4/R	Mic 4	Mic 4
		Headphone L	Mic 1+2+3+4	Mic 1+2+3+4
		Headphone R	Mic 1+2+3+4	Mic 1+2+3+4
1L	LR	1/L	Mic 1	Mic 1
1R		2/R	Mic 2	Mic 1
2L		3/L	Mic 3	Mic 3
2R		4/R	Mic 4	Mic 4
		Headphone L	Mic 1	Mic 1
		Headphone R	Mic 1	Mic 1
1L		1/L	Mic 1	Mic 2
1R	LR	2/R	Mic 2	Mic 2
2L		3/L	Mic 3	Mic 3
2R		4/R	Mic 4	Mic 4
		Headphone L	Mic 2	Mic 2
		Headphone R	Mic 2	Mic 2
1L		1/L	Mic 1	Mic 3
1R		2/R	Mic 2	Mic 3
2L	LR	3/L	Mic 3	Mic 3
2R		4/R	Mic 4	Mic 4
		Headphone L	Mic 2	Mic 2
		Headphone R	Mic 2	Mic 2
1L		1/L	Mic 1	Mic 3
1R		2/R	Mic 2	Mic 3
2L	LR	3/L	Mic 3	Mic 3
2R		4/R	Mic 4	Mic 4
		Headphone L	Mic 3	Mic 3
		Headphone R	Mic 3	Mic 3
1L		1/L	Mic 1	Mic 4
1R		2/R	Mic 2	Mic 4
2L		3/L	Mic 3	Mic 3
2R	LR	4/R	Mic 4	Mic 4
		Headphone L	Mic 4	Mic 4
		Headphone R	Mic 4	Mic 4
1L		1/L	Mic 1	None
1R		2/R	Mic 2	None
2L		3/L	Mic 3	Mic 3
2R		4/R	Mic 4	Mic 4
		Headphone L	None	None
		Headphone R	None	None

Format: STEREO x 2

Channel names	Output Assignment	Output Jack	Output Select (Type)	
			4-indiv	Monitor
1L	L	1/L	Mic 1	Mic 1+3
1R	R	2/R	Mic 2	Mic 2+4
2L	L	3/L	Mic 3	Mic 3
2R	R	4/R	Mic 4	Mic 4
		Headphone L	Mic 1+3	Mic 1+3
		Headphone R	Mic 2+4	Mic 2+4
1L	L	1/L	Mic 1	Mic 1
1R	R	2/R	Mic 2	Mic 2
2L		3/L	Mic 3	Mic 3
2R		4/R	Mic 4	Mic 4
		Headphone L	Mic 1	Mic 1
		Headphone R	Mic 2	Mic 2
1L		1/L	Mic 1	Mic 3
1R		2/R	Mic 2	Mic 4
2L	L	3/L	Mic 3	Mic 3
2R	R	4/R	Mic 4	Mic 4
		Headphone L	Mic 3	Mic 3
		Headphone R	Mic 4	Mic 4
1L	LR	1/L	Mic 1	Mic 1+2+3+4
1R	LR	2/R	Mic 2	Mic 1+2+3+4
2L	LR	3/L	Mic 3	Mic 3
2R	LR	4/R	Mic 4	Mic 4
		Headphone L	Mic 1+2+3+4	Mic 1+2+3+4
		Headphone R	Mic 1+2+3+4	Mic 1+2+3+4
1L	LR	1/L	Mic 1	Mic 1
1R		2/R	Mic 2	Mic 1
2L		3/L	Mic 3	Mic 3
2R		4/R	Mic 4	Mic 4
		Headphone L	Mic 1+2	Mic 1
		Headphone R	Mic 1+2	Mic 1
1L		1/L	Mic 1	Mic 2
1R	LR	2/R	Mic 2	Mic 2
2L		3/L	Mic 3	Mic 3
2R		4/R	Mic 4	Mic 4
		Headphone L	Mic 2	Mic 2
		Headphone R	Mic 2	Mic 2
1L		1/L	Mic 1	Mic 3
1R		2/R	Mic 2	Mic 3
2L	LR	3/L	Mic 3	Mic 3
2R		4/R	Mic 4	Mic 4
		Headphone L	Mic 2	Mic 2
		Headphone R	Mic 2	Mic 2
1L		1/L	Mic 1	Mic 3
1R		2/R	Mic 2	Mic 3
2L	LR	3/L	Mic 3	Mic 3
2R		4/R	Mic 4	Mic 4
		Headphone L	Mic 3	Mic 3
		Headphone R	Mic 3	Mic 3
1L		1/L	Mic 1	Mic 4
1R		2/R	Mic 2	Mic 4
2L		3/L	Mic 3	Mic 3
2R	LR	4/R	Mic 4	Mic 4
		Headphone L	Mic 4	Mic 4
		Headphone R	Mic 4	Mic 4
1L		1/L	Mic 1	None
1R		2/R	Mic 2	None
2L		3/L	Mic 3	Mic 3
2R		4/R	Mic 4	Mic 4
		Headphone L	None	None
		Headphone R	None	None

* Channel names (p. 18)

* Output Assignment (p. 18)

For EU Countries



- UK** This symbol indicates that in EU countries, this product must be collected separately from household waste, as defined in each region. Products bearing this symbol must not be discarded together with household waste.
- DE** Dieses Symbol bedeutet, dass dieses Produkt in EU-Ländern getrennt vom Hausmüll gesammelt werden muss gemäß den regionalen Bestimmungen. Mit diesem Symbol gekennzeichnete Produkte dürfen nicht zusammen mit den Hausmüll entsorgt werden.
- FR** Ce symbole indique que dans les pays de l'Union européenne, ce produit doit être collecté séparément des ordures ménagères selon les directives en vigueur dans chacun de ces pays. Les produits portant ce symbole ne doivent pas être mis au rebut avec les ordures ménagères.
- IT** Questo simbolo indica che nei paesi della Comunità europea questo prodotto deve essere smaltito separatamente dai normali rifiuti domestici, secondo la legislazione in vigore in ciascun paese. I prodotti che riportano questo simbolo non devono essere smaltiti insieme ai rifiuti domestici. Ai sensi dell'art. 13 del D.Lgs. 25 luglio 2005 n. 151.
- ES** Este símbolo indica que en los países de la Unión Europea este producto debe recogerse aparte de los residuos domésticos, tal como está regulado en cada zona. Los productos con este símbolo no se deben depositar con los residuos domésticos.
- PT** Este símbolo indica que nos países da UE, a recolha deste produto deverá ser feita separadamente do lixo doméstico, de acordo com os regulamentos de cada região. Os produtos que apresentem este símbolo não deverão ser eliminados juntamente com o lixo doméstico.
- NL** Dit symbool geeft aan dat in landen van de EU dit product gescheiden van huishoudelijk afval moet worden aangeboden, zoals bepaald per gemeente of regio. Producten die van dit symbool zijn voorzien, mogen niet samen met huishoudelijk afval worden verwijderd.
- DK** Dette symbol angiver, at i EU-lande skal dette produkt opsamles adskilt fra husholdningsaffald, som defineret i hver enkelt region. Produkter med dette symbol må ikke smides ud sammen med husholdningsaffald.
- NO** Dette symbolet indikerer at produktet må behandles som spesialavfall i EU-land, iht. til retningslinjer for den enkelte regionen, og ikke kastes sammen med vanlig husholdningsavfall. Produkter som er merket med dette symbolet, må ikke kastes sammen med vanlig husholdningsavfall.
- SE** Symbolen anger att i EU-länder måste den här produkten kasseras separat från hushållsavfall, i enlighet med varje regions bestämmelser. Produkter med den här symbolen får inte kasseras tillsammans med hushållsavfall.
- FI** Tämä merkintä ilmaisee, että tuote on EU-maissa kerättävä erillään kotitalousjätteistä kunkin alueen voimassa olevien määräysten mukaisesti. Tällä merkinnällä varustettuja tuotteita ei saa hävittää kotitalousjätteiden mukana.
- HU** Ez a szimbólum azt jelenti, hogy az Európai Unióban ezt a terméket a háztartási hulladéktól elkülönítve, az adott régióban érvényes szabályozás szerint kell gyűjteni. Az ezzel a szimbólummal ellátott termékeket nem szabad a háztartási hulladék közé dobni.
- PL** Symbol oznacza, że zgodnie z regulacjami w odpowiednim regionie, w krajach UE produktu nie należy wyrzucać z odpadami domowymi. Produktów opatrzonych tym symbolem nie można utylizować razem z odpadami domowymi.
- CZ** Tento symbol udává, že v zemích EU musí být tento výrobek sbírán odděleně od domácího odpadu, jak je určeno pro každý region. Výrobky nesoucí tento symbol se nesmí vyhazovat spolu s domácím odpadem.
- SK** Tento symbol vyjadruje, že v krajinách EÚ sa musí zber tohto produktu vykonávať oddelene od domového odpadu, podľa nariadení platných v konkrétnej krajine. Produkty s týmto symbolom sa nesmú vyhazovať spolu s domovým odpadom.
- EE** See sümbol näitab, et EL-i maades tuleb see toode olemprügist eraldi koguda, nii nagu on igas piirkonnas määratletud. Selle sümboliga märgitud tooteid ei tohi ära visata koos olmeprügiga.
- LT** Šis simbolis rodo, kad ES šalyse šis produktas turi būti surenkamas atskirai nuo buitinių atliekų, kaip nustatyta kiekviename regione. Šiuo simboliu paženklinėti produktai neturi būti išmetami kartu su buitiniomis atliekomis.
- LV** Šis simbols norāda, ka ES valstīs šo produktu jāievāc atsevišķi no mājsaimniecības atkritumiem, kā noteikts katrā reģionā. Produkts ar šo simbolu nedrīkst izmest kopā ar mājsaimniecības atkritumiem.
- SI** Ta simbol označuje, da je treba proizvod v državih EU zbirati ločeno od gospodinskih odpadkov, tako kot je določeno v vsaki regiji. Proizvoda te tem znakom ni dovoljeno odlagati skupaj z gospodinskimi odpadki.
- GR** Το σύμβολο αυτό υποδηλώνει ότι στις χώρες της Ε.Ε. το συγκεκριμένο προϊόν πρέπει να συλλέγεται χωριστά από τα υπόλοιπα οικιακά απορρίμματα, σύμφωνα με όσα προβλέπονται σε κάθε περιοχή. Τα προϊόντα που φέρουν το συγκεκριμένο σύμβολο δεν πρέπει να απορρίπτονται μαζί με τα οικιακά απορρίμματα.

For China

有关产品中所含有害物质的说明

本资料就本公司产品中所含的特定有害物质及其安全性予以说明。

本资料适用于 2007 年 3 月 1 日以后本公司所制造的产品。

环保使用期限



此标志适用于在中国国内销售的电子信息产品，表示环保使用期限的年数。所谓环保使用期限是指在自制造日起的规定期限内，产品中所含的有害物质不致引起环境污染，不会对人身、财产造成严重的不良影响。环保使用期限仅在遵照产品使用说明书，正确使用产品的条件下才有效。不当的使用，将会导致有害物质泄漏的危险。

产品中有毒有害物质或元素的名称及含量

部件名称	有毒有害物质或元素					
	铅(Pb)	汞(Hg)	镉(Cd)	六价铬(Cr(VI))	多溴联苯(PBB)	多溴二苯醚(PBDE)
外壳(壳体)	×	○	○	○	○	○
电子部件(印刷电路板等)	×	○	×	○	○	○
附件(电源线、交流适配器等)	×	○	○	○	○	○

○：表示该有毒有害物质在该部件所有均质材料中的含量均在 SJ/T11363-2006 标准规定的限量要求以下。

×：表示该有毒有害物质至少在该部件的某一均质材料中的含量超出 SJ/T11363-2006 标准规定的限量要求。

因根据现有的技术水平，还没有什么物质能够代替它。



For EU Countries

This product complies with the requirements of EMC Directive 2004/108/EC.

For the USA

FEDERAL COMMUNICATIONS COMMISSION RADIO FREQUENCY INTERFERENCE STATEMENT

This equipment has been tested and found to comply with the limits for a Class B digital device, pursuant to Part 15 of the FCC Rules. These limits are designed to provide reasonable protection against harmful interference in a residential installation. This equipment generates, uses, and can radiate radio frequency energy and, if not installed and used in accordance with the instructions, may cause harmful interference to radio communications. However, there is no guarantee that interference will not occur in a particular installation. If this equipment does cause harmful interference to radio or television reception, which can be determined by turning the equipment off and on, the user is encouraged to try to correct the interference by one or more of the following measures:

- Reorient or relocate the receiving antenna.
- Increase the separation between the equipment and receiver.
- Connect the equipment into an outlet on a circuit different from that to which the receiver is connected.
- Consult the dealer or an experienced radio/TV technician for help.

This device complies with Part 15 of the FCC Rules. Operation is subject to the following two conditions:

- (1) this device may not cause harmful interference, and
- (2) this device must accept any interference received, including interference that may cause undesired operation.

This equipment requires shielded interface cables in order to meet FCC class B limit.

Any unauthorized changes or modifications not expressly approved by the party responsible for compliance could void the user's authority to operate the equipment.

For Canada

NOTICE

This Class B digital apparatus meets all requirements of the Canadian Interference-Causing Equipment Regulations.

AVIS

Cet appareil numérique de la classe B respecte toutes les exigences du Règlement sur le matériel brouilleur du Canada.

For Korea

사용자 안내문

기종별	사용자 안내문
B 급 기기 (가정용 방송통신기자재)	이 기기는 가정용(B 급) 전자파적합기기로서 주로 가정에서 사용하는 것을 목적으로 하며, 모든 지역에서 사용할 수 있습니다.

For C.A. US (Proposition 65)

WARNING

This product contains chemicals known to cause cancer, birth defects and other reproductive harm, including lead.

Roland



* 5 1 0 0 0 3 6 0 6 0 - 0 2 *