

OEI-2

OMNEO External Interface - 2 Channel

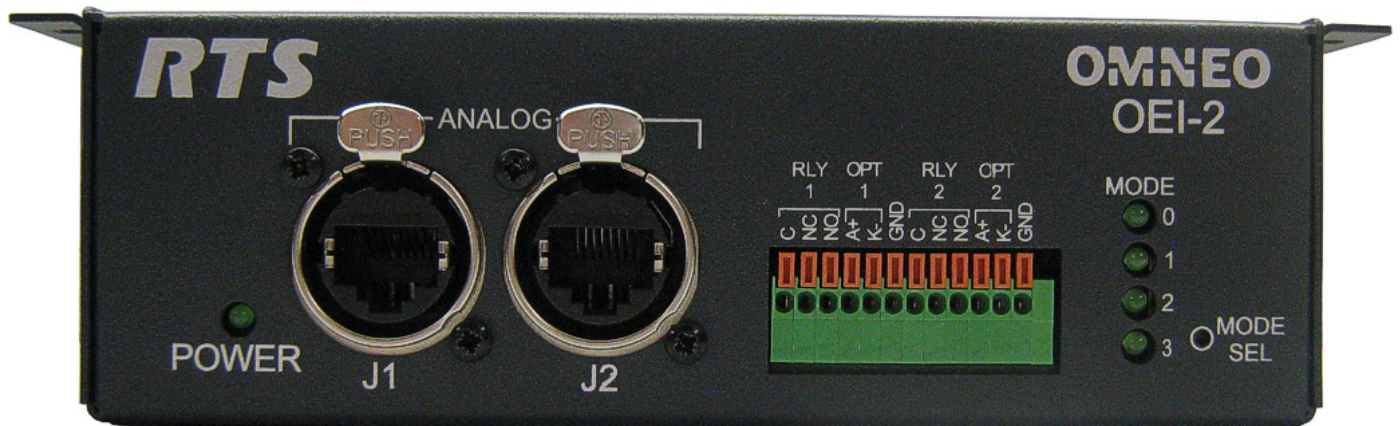

PROPRIETARY NOTICE

The product information and design disclosed herein were originated by and are the property of Bosch Security Systems, Inc. Bosch reserves all patent, proprietary design, manufacturing, reproduction, use and sales rights thereto, and to any article disclosed therein, except to the extent rights are expressly granted to others.

COPYRIGHT NOTICE

Copyright 2014 by Bosch Security Systems, Inc. All rights reserved. Reproduction, in whole or in part, without prior written permission from Bosch is prohibited.

*All other trademarks are property of their respective owners.

WARRANTY AND SERVICE INFORMATION

For warranty and service information, refer to the appropriate web site below:

- RTS Intercoms www.rtsintercoms.com/warranty
- RTS Digital
- RTSTW
- AudioCom
- RadioCom
- Intercom Headsets..... www.telex.com

CUSTOMER SUPPORT

Technical questions should be directed to:



Customer Service Department
Bosch Security Systems, Inc.
www.telex.com

TECHNICAL QUESTIONS EMEA

Bosch Security Systems Technical Support EMEA
http://www.rtsintercoms.com/contact_main.php

DISCLAIMER

The manufacturer of the equipment described herein makes no expressed or implied warranty with respect to anything contained in this manual and shall not be held liable for any implied warranties of fitness for a particular application or for any indirect, special, or consequential damages. The information contained herein is subject to change without prior notice and shall not be construed as an expressed or implied commitment on the part of the manufacturer.

	CAUTION RISK OF ELECTRIC SHOCK DO NOT OPEN	
THE LIGHTNING FLASH AND ARROWHEAD WITHIN THE TRIANGLE IS A WARNING SIGN ALERTING YOU OF "DANGEROUS VOLTAGE" INSIDE THE PRODUCT.	CAUTION: TO REDUCE THE RISK OF ELECTRIC SHOCK, DO NOT REMOVE COVER. NO USER-SERVICABLE PARTS INSIDE. REFER SERVICING TO QUALIFIED SERVICE PERSONNEL.	THE EXCLAMATION POINT WITHIN THE TRIANGLE IS A WARNING SIGN ALERTING YOU OF IMPORTANT INSTRUCTIONS ACCOMPANYING THE PRODUCT.
SEE MARKING ON BOTTOM/BACK OF PRODUCT.		

WARNING: APPARATUS SHALL NOT BE EXPOSED TO DRIPPING OR SPLASHING AND NO OBJECTS FILLED WITH LIQUIDS, SUCH AS VASES, SHALL BE PLACED ON THE APPARATUS.

WARNING: THE MAIN POWER PLUG MUST REMAIN READILY OPERABLE.

CAUTION: TO REDUCE THE RISK OF ELECTRIC SHOCK, GROUNDING OF THE CENTER PIN OF THIS PLUG MUST BE MAINTAINED.

WARNING: TO REDUCE THE RISK OF FIRE OR ELECTRIC SHOCK, DO NOT EXPOSE THIS APPRATUS TO RAIN OR MOISTURE.

WARNING: TO PREVENT INJURY, THIS APPARATUS MUST BE SECURELY ATTACHED TO THE FLOOR/WALL/RACK IN ACCORDANCE WITH THE INSTALLATION INSTRUCTIONS.

~	This product is AC only.
---	--------------------------

CE	
-----------	--

Important Safety Instructions

1. Read these instructions.
2. Keep these instructions.
3. Heed all warnings.
4. Follow all instructions.
5. Do not use this apparatus near water.
6. Clean only with dry cloth.
7. Do not block any ventilation openings. Install in accordance with the manufacturer's instructions.
8. Do not install near any heat sources such as radiators, heat registers, stoves, or other apparatus (including amplifiers) that produce heat.
9. Do not defeat the safety purpose of the polarized or grounding-type plug. A polarized plug has two blades with one wider than the other. A grounding type plug has two blades and a third grounding prong. The wide blade or the third prong are provided for your safety. If the provided plug does not fit into your outlet, consult an electrician for replacement of the obsolete outlet.
10. Protect the power cord from being walked on or pinched particularly at plugs, convenience receptacles, and the point where they exit from the apparatus.
11. Only use attachments/accessories specified by the manufacturer.
12. Use only with the cart, stand, tripod, bracket, or table specified by the manufacturer, or sold with the apparatus. When a cart is used, use caution when moving the cart/apparatus combination to avoid injury from tip-over.
13. Unplug this apparatus during lightning storms or when unused for long periods of time.
14. Refer all servicing to qualified service personnel. Servicing is required when the apparatus has been damaged in any way, such as power-supply cord or plug is damaged, liquid has been spilled or objects have fallen into the apparatus, the apparatus has been exposed to rain or moisture, does not operate normally, or has been dropped.

Table of Contents

INTRODUCTION	7
Description	7
Features	7
Reference View	8
Specifications	9
Connectors	10
System Drawings	12
 INSTALLATION	 17
System Requirements	17
Installation Instructions	18
 CONFIGURATION	 21
OEI-2 Power Cycle	21
Software Configuration	21
Firmware Upload – OEI-2	25
LED Indicators	26
User Modes	28
 OPTIONAL POWER SUPPLY MOUNT	 37
Power Supply Rackmount Assembly Instructions	37

Description

Offering the latest in state of the art technology, the OEI-2 enables connectivity between analog audio sources or legacy RTS keypanels and an OMNEO network. OMNEO sets the standard for the future of audio communications by offering high quality IP compatible audio, ultra low latency, and supports DHCP and Bonjour protocols. OEI-2 supports all RTS analog keypanels.

Features

- Provides an interface between legacy RTS keypanels and the OMI OMNEO interface cards for ADAM and ADAM-M units.
- Provides less than 20ms of audio latency in typical network installations.
- Provides a frequency response of 20Hz to 20KHz to the keypanel
- Supports IP version 4 DHCP and device discovery for easy set up and network management.
- Supports an optional fiber connection to the keypanel (multi-mode or single-mode).
- Supports CAT-5/5e and CAT-6 with dual Ethernet connectors for device looping.
- Supports compatibility with third-party Dante products.

Reference View

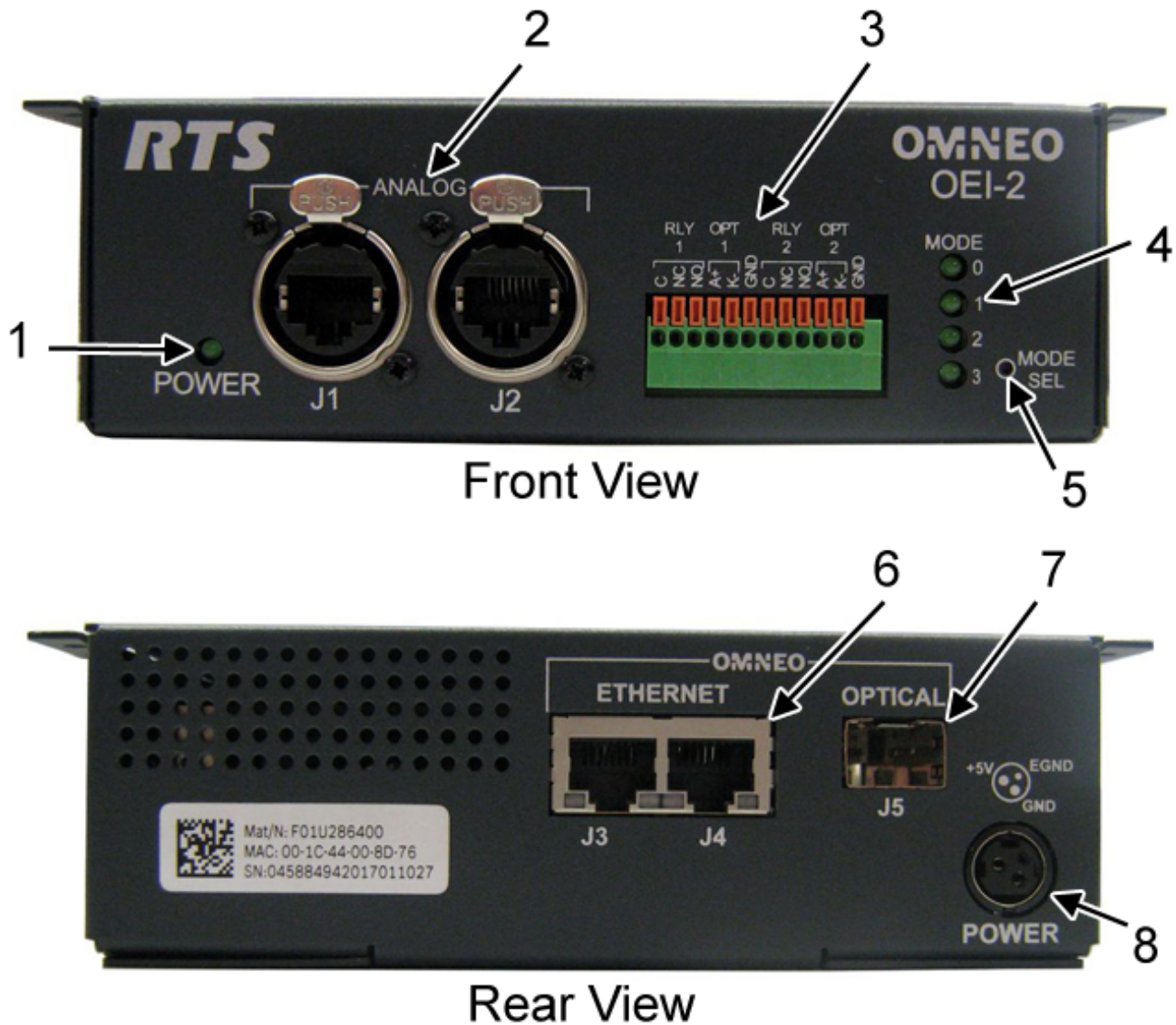

FIGURE 1. OEI-2 Reference View

1. Power Light Indicator
2. Channel 1 and Channel 2 – Ethercon RJ-45 Connectors
3. Relay and Opto Isolate Terminal Block
4. Mode Indicator Lights
5. Mode Selection Switch
6. Ethernet Connectors
7. Fiber Connector
8. Power Connector

Specifications

General

Dimensions.....	5.80in x 1.93in x 4.45in (147mm x 49mm x 113mm)
Weight	23.2 oz (658g)

Power

Requirements.....	5VDC, 2000mA
Power Consumption @ 120VAC	21VA
Power Consumption @ 220VAC	27VA

Connectors

2– RJ-45 Ethernet Connectors	
SFP Fiber Connector	LC Type
GP Inputs 1–2	
Type.....	Optically coupled
Input	Internal pull-up resistor to 5VDC
	External power up 5–18VDC
GP Outputs 1–2	
Type.....	relays with common normal open and normal closed contacts
Contact Ratings	1.0 Amp @ 30VDC
Data Keypanel.....	RS485

Analog

Input

Type.....	Balanced floating
Level Nominal.....	8dBu
Level Maximum	20dBu
Impedance	10k Ω

Output

Type.....	Balanced floating
Level Nominal.....	8dBu
Level Maximum	20dBu
Impedance	600 Ω
THD+Noise	<0.1% (measured at 20-20kHz, +0 dBu, unity gain)

Digital

Audio

Frequency Response.....	20Hz to 20kHz; \pm 0.1dB
System Gain	0 dB

Bandwidth

48kHz/24-bit per channel.....	2.59Mbit/s
Analog to OMI latency.....	20ms
OMI to Analog latency.....	20ms

Environmental

Storage Temperature	-4°F to 158°F (-20°C to 70°C)
Operating Temperature.....	32°F to 131°F (0°C to 55°C)

Connectors

RJ-45 Pinout

TABLE 1. RJ-45 Analog Connector Pin Out

Pin	Description	
	KP Mode	Audio Mode
1	RS485 Data +	NA
2	RS485 Data -	NA
3	Audio Out +	Audio In+
4	Audio In +	Audio Out+
5	Audio In -	Audio Out -
6	Audio Out -	Audio In -
7	RS485 Data +	NA
8	RS485 Data -	NA

IMPORTANT: Keypans support RTS protocol, USOC, and 568B CAT-5e wiring scheme for RS485 data.

Terminal Block

RLY 1	C
	NC
	NO
OPT 1	A ^{+a}
	K ^{-b}
	GND
RLY 2	C
	NC
	NO
OPT 2	A+
	K-
	GND

a. Anode

b. Cathode

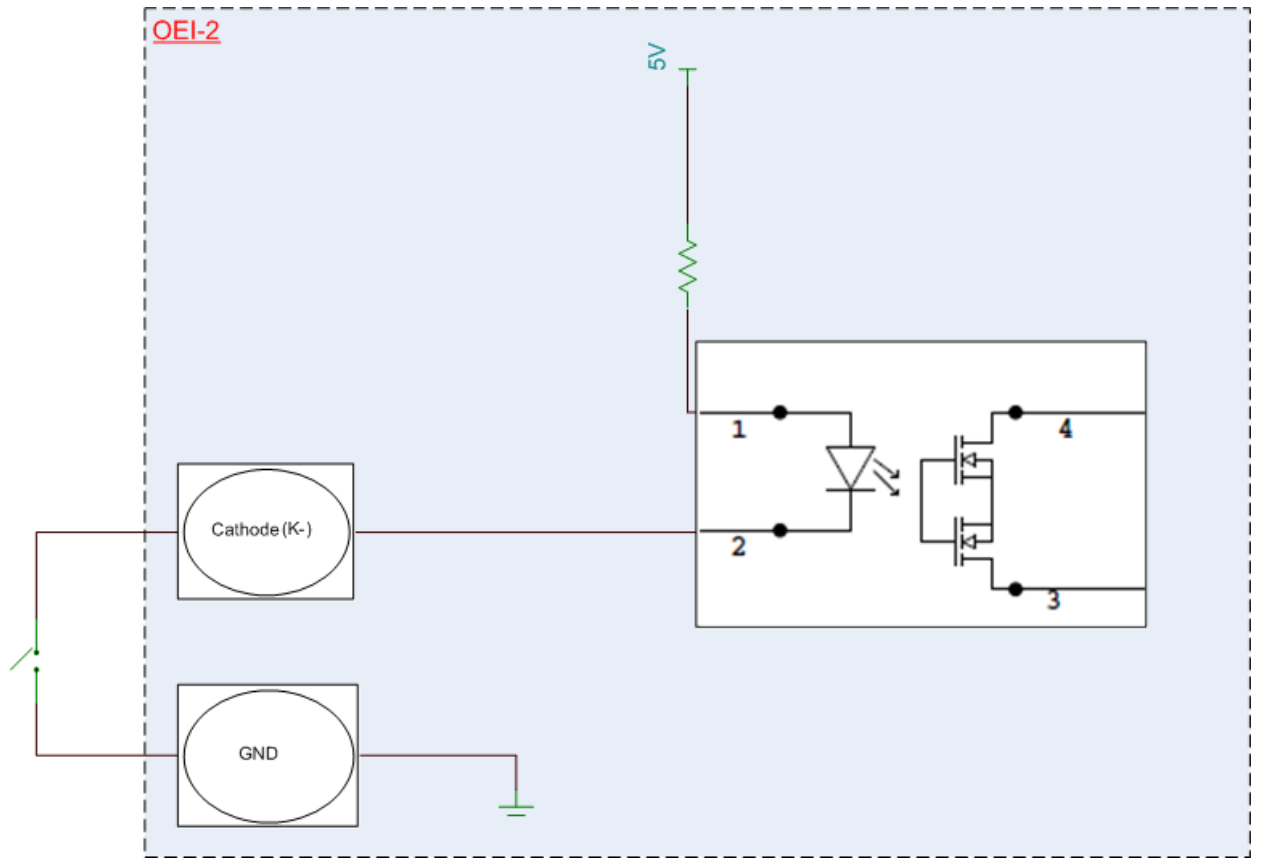

FIGURE 2. GPIO Input Diagram

System Drawings

Same Frame, Same OMI Card

IMPORTANT: An OMI Card is necessary for operation.

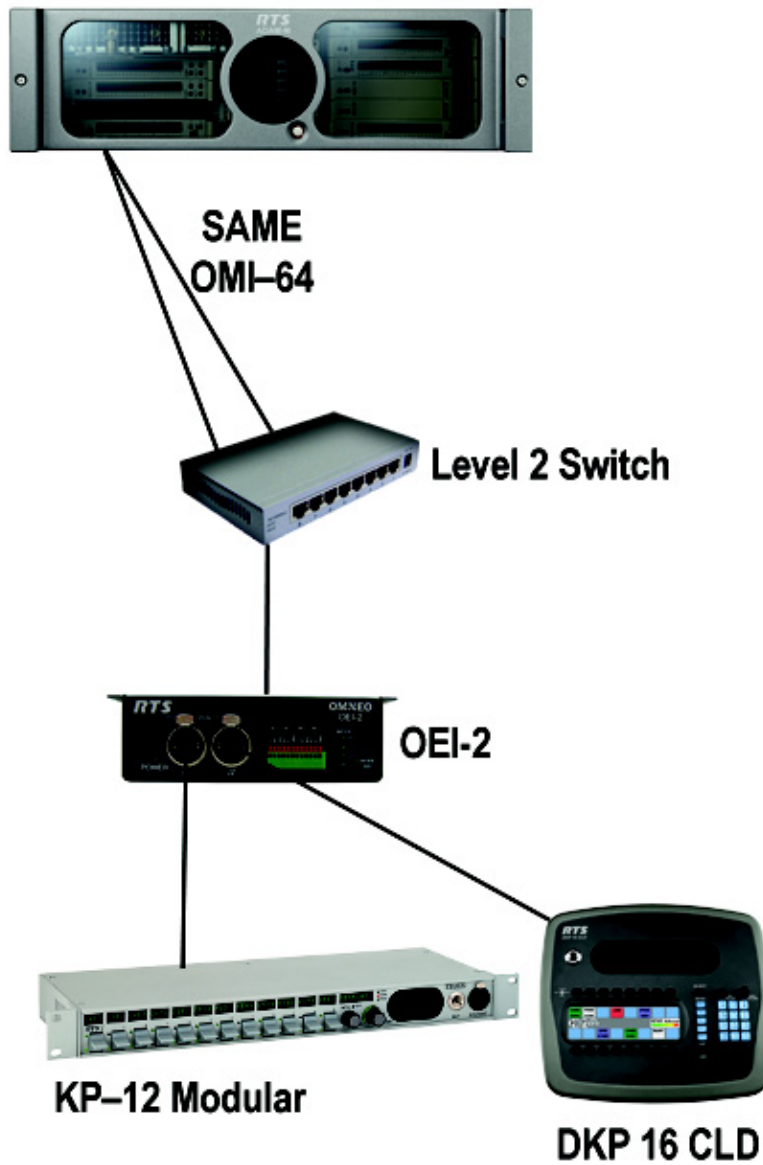

FIGURE 3. Same Frame, Same OMI Card System

Same Frame, Different OMI Cards

IMPORTANT: An OMI Card is necessary for operation.

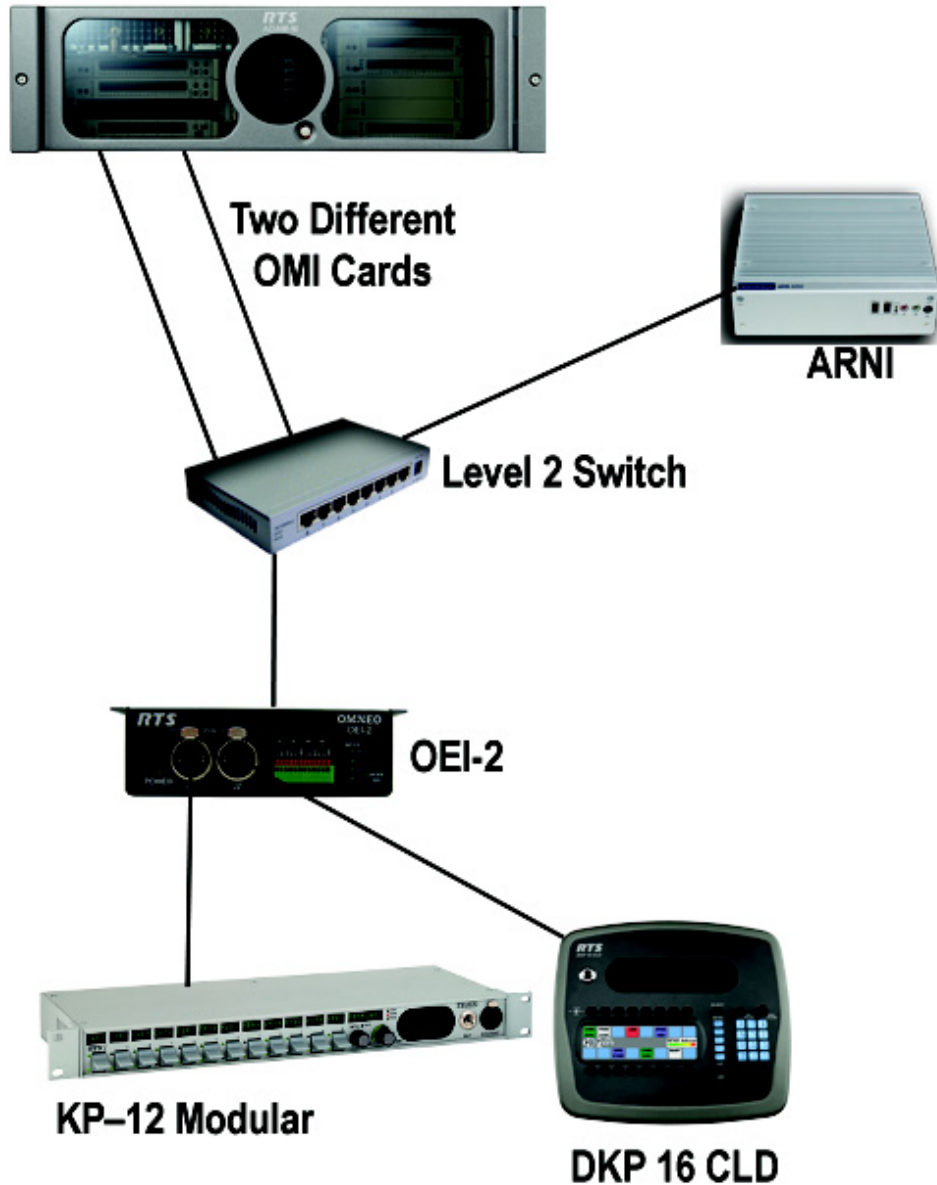

FIGURE 4. Same Frame, Different OMI Cards System

IMPORTANT: ARNI is only required, if access beyond each subnet is desired by the OMI cards.

Different Frames, Different OMI Cards

IMPORTANT: An OMI Card is necessary for operation.

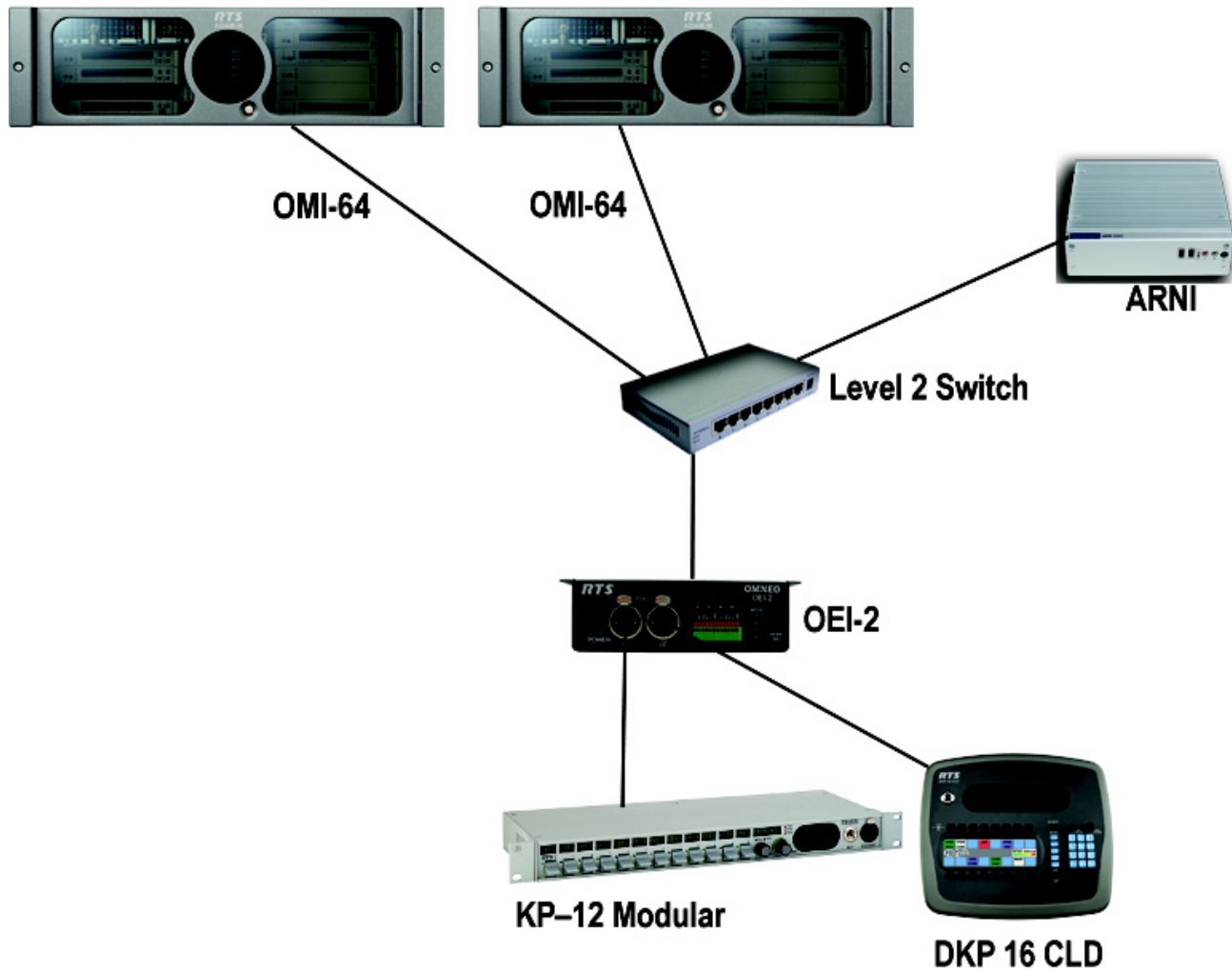

FIGURE 5. Different Frames and Different OMI Cards System

IMPORTANT: ARNI is only required, if access beyond each subnet is desired by the OMI cards.

Audio Only

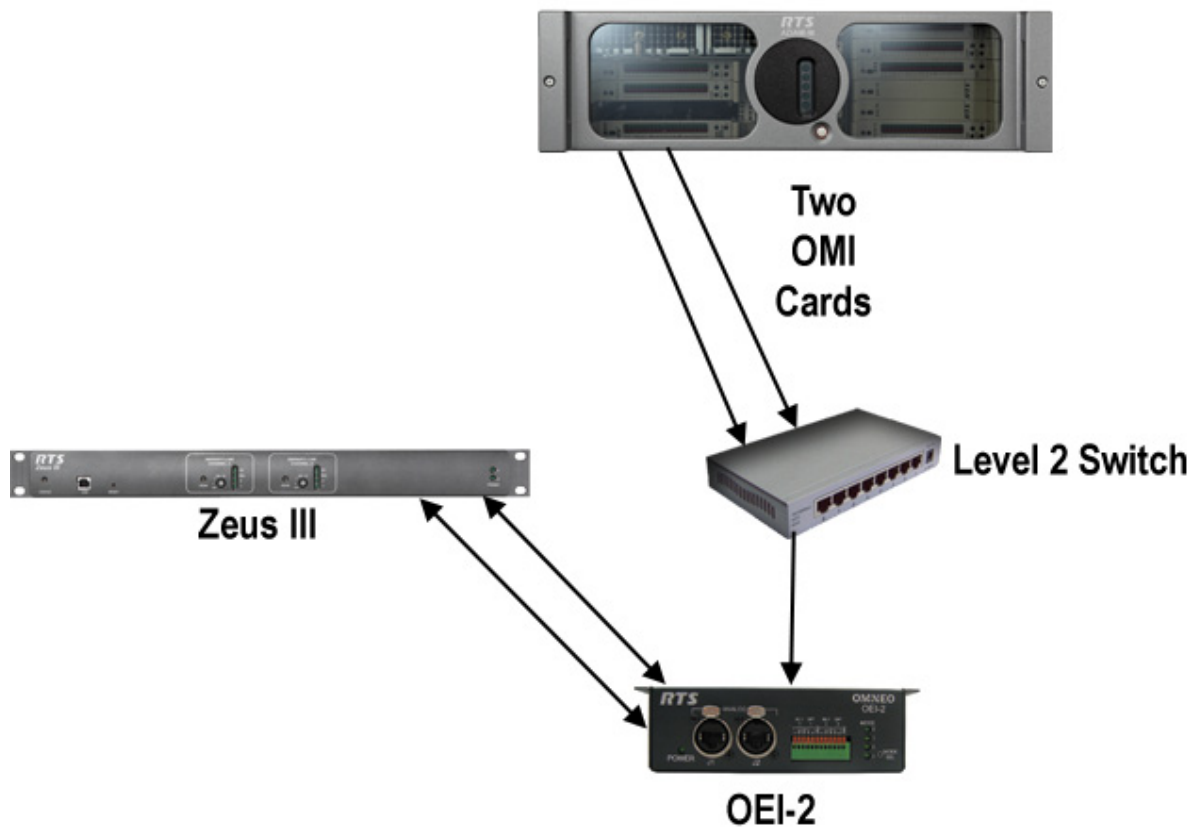

FIGURE 6. Audio Only System

IMPORTANT: ARNI is only required, if access beyond each subnet is desired by the OMI cards.

System Requirements

You must have the following:

- OEI-2 version 1.1.4 or later
- OMI version 5.1.3 or later
- OKI version 5.1.3 or later
- IPedit version 3.1.0 or later
OR
AZedit version 4.7.0 or later
- FWUT version 3.0.3 or later

Installation Instructions

Mounting the Unit

To **mount the OEI-2 to the underside of a desk**, do the following:

1. Holding the OEI-2 unit in the spot you want to mount it, make **guide marks**, using a marker, for the screw placement.

TIP: To make attaching the unit easier, pre-drilling the screw holes is suggested.

2. Using a screwdriver, attach the **OEI-2 unit** to the predefined mounting area with the four (4) screws supplied.

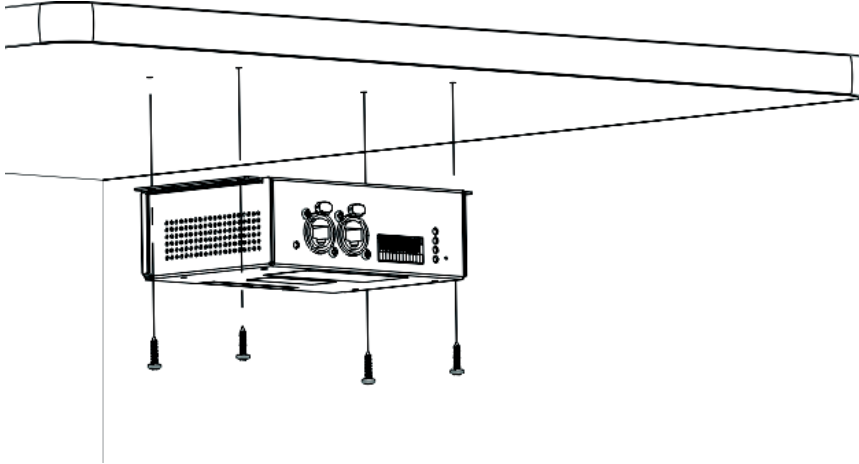

Cabling

To **install the OEI-2**, do the following:

1. On the rear of the OEI-2 unit, connect either the **Ethernet** (J3 or J4) or **Optical** connector (J5) to a switch or OMNEO device connected to the Matrix.

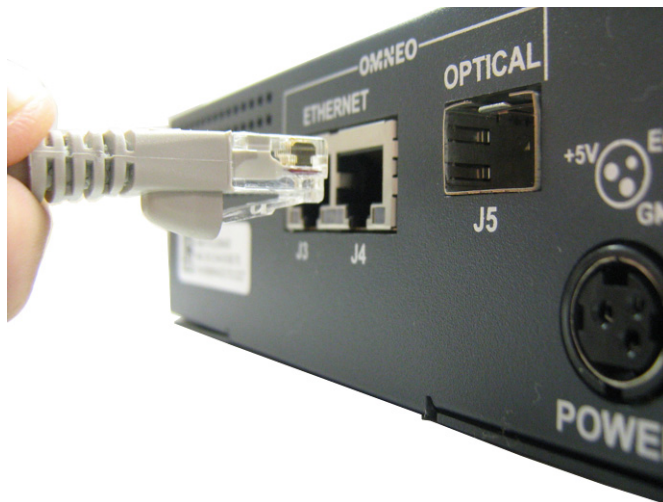

2. On the front of the OEI-2 unit, connect **J1** or **J2** to the Frame connector on the keypanel.



3. Connect **one end of the power supply** to the OEI-2 and the other end to the **wall outlet**.
The OEI-2 powers on. On initial power up, only the Power LED is seen.

NOTE: If you need to mount the power supply (P/N RP_OEI_PS_BRK), see “Optional Power Supply Mount” on page 37.



4. Using IPedit or AZedit, **configure the OMI with the OEI-2**. See “Configure an OEI-2 Using AZedit” on page 21 or “Configure an OEI-2 Using IPedit” on page 23.

OEI-2 Power Cycle

The OEI-2 has an external switch primarily used to power cycle the unit without disrupting power to the unit. For more information, see “Power On Reset” on page 36.

To **power cycle the OEI-2 unit**, do the following:

1. Using a straightened paperclip, press and hold the **MODE SEL button for 10 seconds**.
The POWER and MODE LEDs start blinking.
1. Remove the **straightened paperclip** from the MODE SEL button.
The POWER LED turns off. The OEI-2 is power cycled.

Software Configuration

Configure an OEI-2 Using AZedit

To **configure an OEI-2 with an OMI card using AZedit**, do the following:

1. Start **AZedit**.
2. From the Status menu, select **I/O Cards**.
The I/O Card Status window appears displaying a list of recognized cards.
3. Right-click an **OMI card**.
A pop-up menu appears.

- From the pop-up menu, select **OMNEO Configuration**.
The OMNEO Configuration window appears.

- Verify the **Settings for OMNEO Card** information is correct.
- From the Local Channel drop down list, select the **channel** you want to use to communicate from the OMI to the OEI-2 device.

NOTE: Non-allocated channels appear with an asterisk next to them.

- Select the **Browse icon** to open the Discovered Devices window from which you can choose the device.
The Partner IP Address field automatically populates.

OR

In the Partner Device Name field, enter the name of the **OEI-2** you want to communicate with.

- From the Partner Device Type drop down menu, select **OEI-2**.

NOTE: If the system detects the type of device it is, the Partner Device Type automatically populates.

- From the Partner Channel drop down menu, select the **channel** on the OEI-2 to which the OMI communicates.
- Click **Apply**.

Configure an OEI-2 Using IPedit

To configure an OEI-2 with an OMI card using IPedit, do the following:

IMPORTANT: You must be signed on with network administrator rights to complete these instructions.

1. Start **IPedit**.
2. From the Device menu, select **Add**.
The Add Devices window appears.

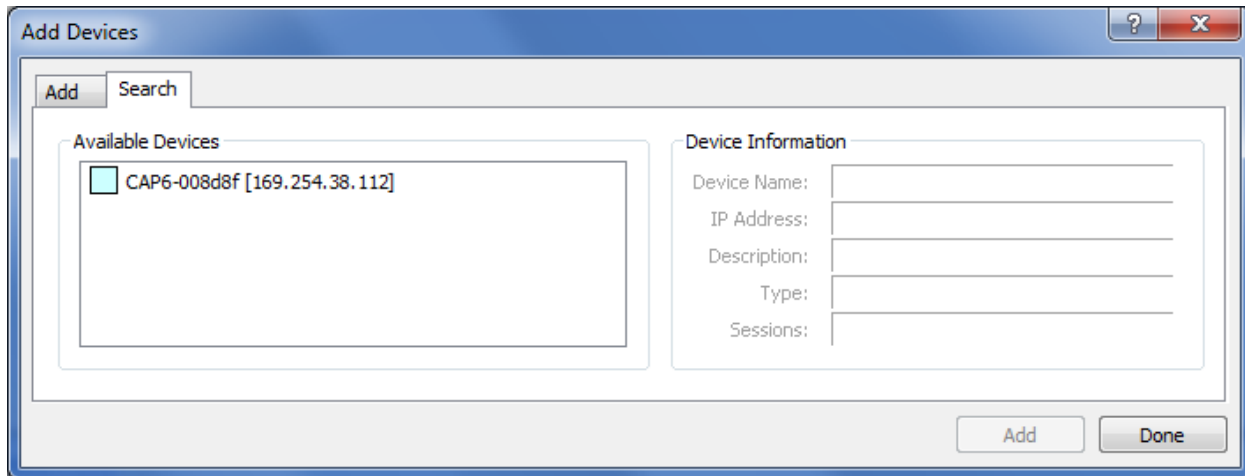

3. From the Available Devices pane, select the **OEI-2 device**.
The Add button becomes active.
4. Click **Add**.
The OEI-2 appears in the device catalog in the left panel.
5. Click **Done**.
The Add Devices window closes.

6. From the Device Catalog on the left, select the **OEI-2 device**.
The Channel Configuration and Status Section populates.

	Channel 1	Channel 2
Channel Configuration		
Channel Description		
Destination Type	<input type="checkbox"/> OMI-16	<input type="checkbox"/> OMI-16
Destination Device Name		
Destination IP Address	-	-
Destination Description		
Destination Channel	Channel 6 ▾	Channel 7
Destination Channel Description		
Channel Input Gain	0 dB	0 dB
Channel Output Gain	0 dB	0 dB
Invert Audio Direction	<input checked="" type="checkbox"/>	<input checked="" type="checkbox"/>
Channel Status		

7. From the column headings, select the **channel** you want to configure (for example, Channel 1 or Channel 2).
8. In the Channel Description field, enter a **channel description**, if applicable.
9. From the Destination Type drop down menu, select the **OMI card** to which the channel is connected.
10. In the Destination Device Name field, enter the **name** of the OMI card to which the channel is connected.
 OR
 Click the **browse button**.
The Discovered Devices window appears.
- Expand the **local tree** to view the destination devices available.
 - From the expanded tree, select the **device** you want for you destination device.
 - Click **OK**.
The Discovered Devices window closes.
11. From the Destination Channel drop down menu, select the **destination channel** to which the channel is connected.
12. From the File menu, click **Save**.

Firmware Upload – OEI-2

To upload firmware to the OEI-2 unit, do the following:

1. Start IPedit.

NOTE: The OEI-2 unit must be configured before you upgrade the firmware. For more information, see “Configure an OEI-2 Using IPedit” on page 23.

2. Select the **OEI-2 device** you want to update.
3. Right-click the **OEI-2 device** you want to update.
A popup menu appears.
4. From the popup menu, select **Download Firmware**.
The OMNEO Firmware Upload Tool starts.
5. From the Network adapter drop down menu, select the **network adapter** you are using.
6. Click **OK**.
The OMNEO Firmware Upload Tool window appears.
7. Click the **OEI-2 tab**.
The OEI-2 page appears.
8. Select the **OEI-2 device**.
9. Click **Upload**.
The Select firmware for upload window appears.

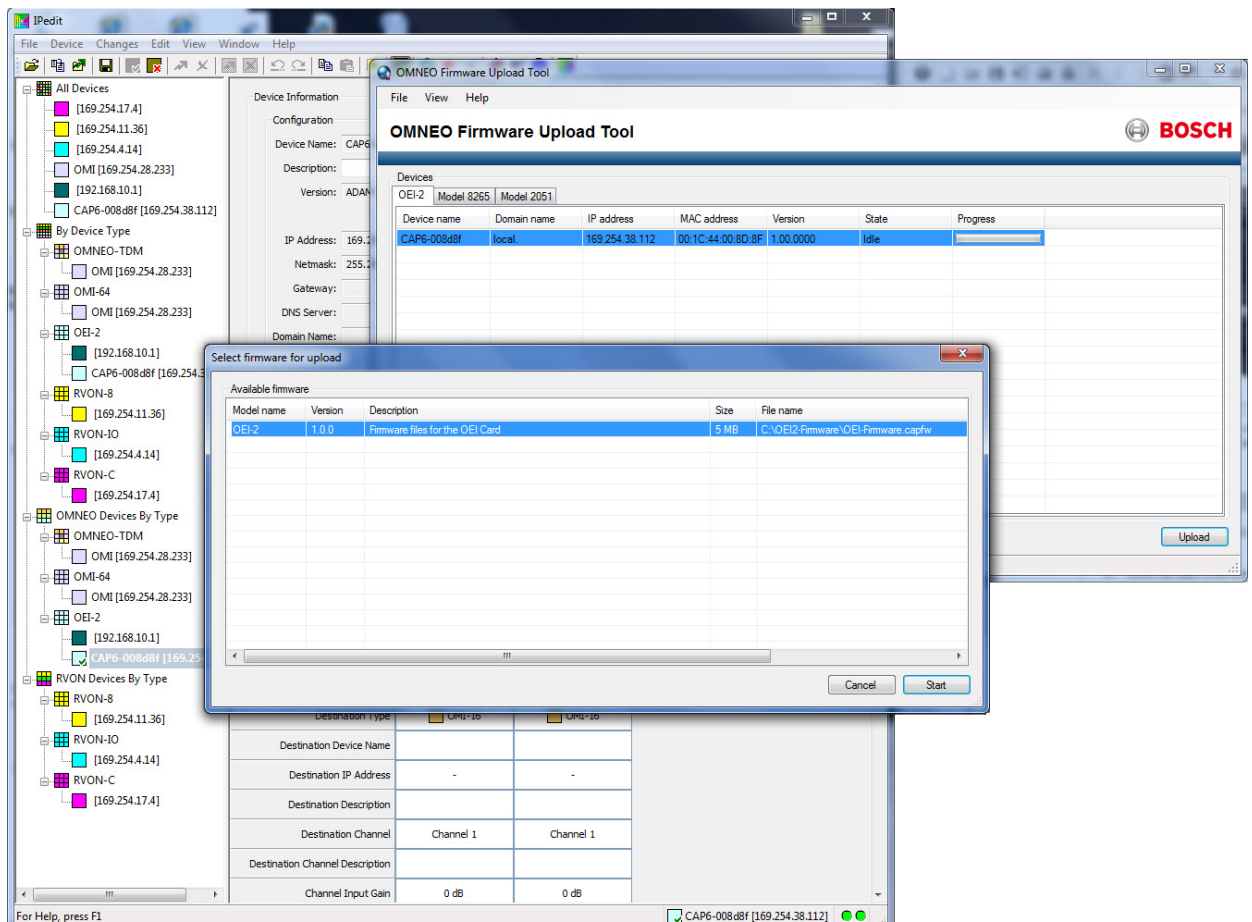

10. Select the **OEI-2 Firmware**.
The Start button becomes active.
11. Click **Start**.
The firmware begins to upload to the OEI-2 device.

LED Indicators

Power Indicator LED

The **Power Indicator** LED, located on the lower left corner of the OEI-2 front panel, indicates if power is being supplied to the unit or if there is a communication failure between the OEI-2 and the OMI.

When power is supplied to the unit, the power indicator LED is a constant green.



FIGURE 7. Powered OEI-2 Unit

NORMAL Operation

In **Normal** operation mode the OEI-2 unit displays LED indication for channel 1 and channel 2.

The channel indicator LEDs are as follows:

Channel 1 is represented by the LED 0

Channel 2 is represented by the LED 1

When blinking is seen on LED 0 or LED 1, this indicates the keypanels are connected and are configured.



FIGURE 8. Keypanels Connected and Configured

If a keypanel is connected to the OEI-2 unit, but is not configured, the LED is off.



FIGURE 9. Two (2) Keypanels Connected and One (1) Keypanel Not Configured

FAULT Indicator

When there is a communication failure, or a FAULT the power indicator starts blinking.



FIGURE 10. FAULT Indicator

User Modes

User Mode Selection

User Modes are used to define how the OEI-2 handles different requests, such as changing the IP Address of the OEI-2 unit, changing the direction of the audio, configuring GPIO Modes, and reset configuration options. The User Modes are as follows:

- Mode 0 – IP Change Mode*
- Mode 1 – Audio Direction*
- Mode 2 – Set GPIO Mode*
- Mode 3 – Select Port GPIO*

RTS IPedit Configuration Software must be used to configure the modes. Three (3) of the modes can be configured from the front panel of the OEI-2; IP Change Mode, Reset Configuration, and Power On Reset.

Mode 0 - IP Change Mode

IP Change Mode allows the user to change the IP address of the unit through the use of a keypanel connected to port 1 on the OEI-2 unit (see Figure 1, “OEI-2 Reference View,” on page 8).

NOTE: Once the mode is selected, any power cycles performed will not reset this selection to default.

By default, the IP Change Mode is disabled. However, it can be toggled on and off using the **MODE SEL** button, located in the lower-left corner on the front panel of the OEI-2 unit. The IP Change Mode also can be enabled and disabled through the IPedit interface software.

To **enable IP Change Mode from the OEI-2 unit**, do the following:

1. Using a straightened paper clip, press the **MODE SEL button** once.
IP Mode changes.
2. Continue pressing the **MODE SEL button** to cycle through the different modes.

IMPORTANT: To indicate the IP Change Mode is enabled, the **MODE 3 LED** flashes for five (5) seconds, and then it resumes its previous activity.

IMPORTANT: For instructions on changing the IP Address of the OEI-2 device from the Keypanel, refer to the specific keypanel manual.

IMPORTANT: Only OMNEO menu enabled devices can modify the IP Address of an OEI-2 device.



To **enable IP Change Mode from IPedit**, do the following:

1. Start **IPedit**.
2. From the left navigation, select the **OEI-2** device you want to configure.
The Device Information panel populates.

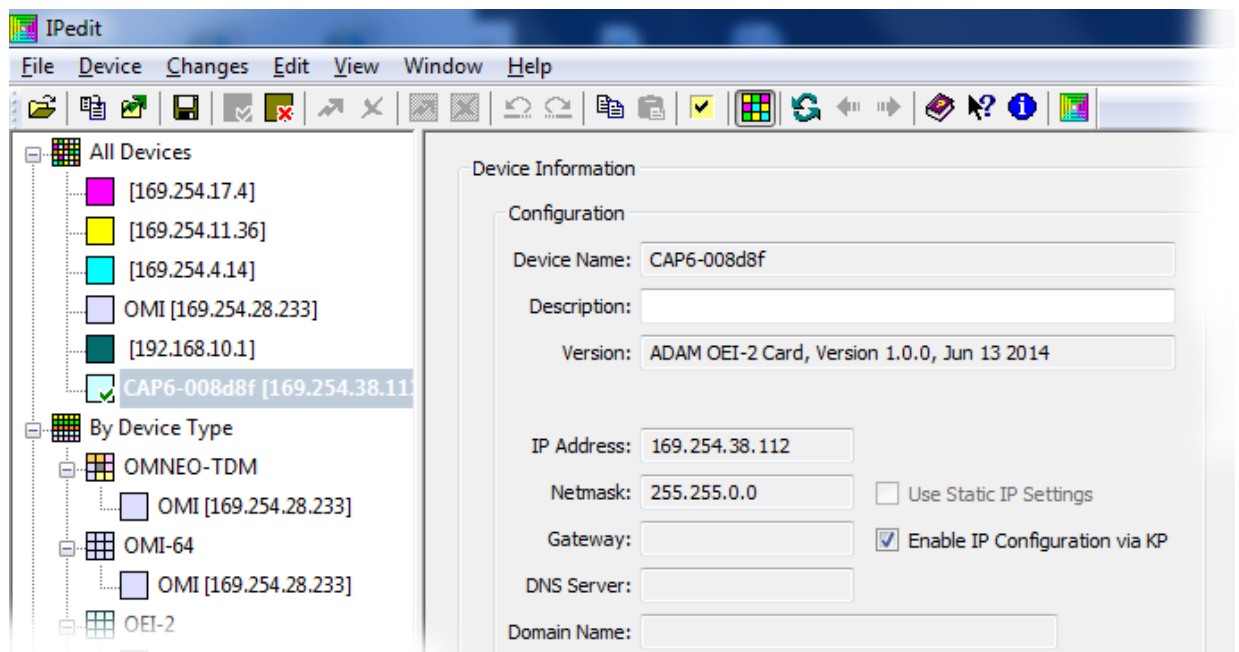

3. Select the **Enable IP Configuration via KP** check box.

IMPORTANT: For instructions on changing the IP Address of the OEI-2 device from a specific keypanel, refer to the appropriate keypanel manual.

Change the IP Address of the OEI-2 device from an RP-1000

NOTE: Only OMNEO menu enabled devices can modify the IP Address of an OEI-2 device.

To **select the fixed addressing for the OMNEO device**, do the following:

1. Using the arrow keys, select **OMNEO Setup**.
2. Tap **PGM**.
Device Name appears.
3. Using the arrow keys, scroll to **DHCP**
4. Tap **PGM**.
Disabled and Enabled appear in the display.
5. Using the arrow keys, select **Fixed IP**.
6. Tap **PGM**.
The addressing type is set.

To **configure the IP Parameters for the OMNEO device**, do the following:

1. Using the arrow keys, select **OMNEO Setup**.
2. Tap **PGM**.
Device Name, DHCP, and IP Parameters appear in the display.
3. Using the arrow keys, scroll to **IP Parameters**.
4. Tap **PGM**.
IP Address appears in the keypanel display.
5. Tap **PGM**.
The IP Address octet appears in the keypanel display with the first octet blinking.
6. Using the keypad, enter the **IP Address**.
Use the PGM key as the dots between octets.
7. When finished entering the IP Address, tap **PGM**.
Netmask appears in the keypanel display.
8. Tap **PGM**.
The Netmask octet appears in the keypanel display with the first octet blinking.
9. Using the keypad, enter the **Netmask**, if necessary.
Use the PGM key as the dots between octets.
10. When finished entering the Netmask, tap **PGM**.
Gateway appears in the keypanel display.
11. Using the keypad, enter the **Gateway**, if necessary.
Use the PGM key as the dots between octets.
12. When finished entering the Gateway, tap **PGM**.
The DNS Svr 1 appears in the keypanel display.
13. Using the keypad, enter the **DNS Svr 1 address**, if necessary.
Use the PGM key as the dots between octets.
14. When finished entering the DNS Svr 1 address, tap **PGM**.
Domain appears in the keypanel display.
15. Tap **PGM**.
The Domain name appears in the keypanel display with the first character blinking.
16. Using the arrows, scroll to the to the **first character of the device name** desired.

- 17. Tap **PGM**.
The focus moves to the next character in the device name.

NOTE: You can also use the volume control to move the cursor position to the left and right.

- 18. Repeat **steps 19 and 20** until the Domain Name is entered.
CLR deletes the current character. 0 can be used to insert a character at the current position. Scroll up/scroll down can also be used to move the current cursor position.
- 19. Tap **FWD** to exit.
- 20. Select **Save Cfg** to store the OMNEO Setup settings.

Mode 1 - Audio Direction Selection

Audio Direction Selection mode allows the user to change the direction of the audio on the OEI-2. This means the audio output port can be changed to become the audio input port for their respective ports. This allows the user to connect audio channels directly to an AIO-16 breakout panel or to the Zeus III ports.

By default, the OEI-2 channels receive audio from the matrix. However, you can modify the configuration to send audio to the matrix. This is done using the IPedit software application.



FIGURE 11. Audio Direction Mode

Mode 1a - Audio on CH1 and Audio+Data on CH2



FIGURE 12. Audio Direction Mode – Channel 1

Mode 1b - Audio+Data on CH1 and Audio on CH2



FIGURE 13. Audio Direction Mode – Channel 2

Change the Channel Audio Direction via IPedit

To change the channel audio direction using IPedit, do the following:

1. Start **IPedit**.
2. From the left navigation pane, select the **OEI-2** device you want to modify.
The Device Information and Channel Status information populates.

The screenshot shows the IPedit interface. On the left is a tree view of devices, including OMI [169.254.28.233], OEI-2 [192.168.10.1], CAP6-008d8f [169.254.38.1], and several RVON devices. On the right is a configuration table for Channel 1 and Channel 2. The 'Invert Audio Direction' row is highlighted in yellow, with the checkbox for Channel 2 being unchecked.

	Channel 1	Channel 2
Destination Type	<input type="checkbox"/> OMI-16	<input type="checkbox"/> OMI-16
Destination Device Name		
Destination IP Address	-	-
Destination Description		
Destination Channel	Channel 1	Channel 1
Destination Channel Description		
Channel Input Gain	0 dB	0 dB
Channel Output Gain	0 dB	0 dB
Invert Audio Direction	<input checked="" type="checkbox"/>	<input type="checkbox"/>
Channel Status		
Connection State	Idle	Idle

For Help, press F1

3. From the Channel Status, Invert Audio Direction Row, select the **Channel check box** you want to modify (either channel 1 or channel 2).

Mode 2 - Set GPIO Mode

NOTE: The Set GPIO Mode can only be configured using IPedit or from the front panel.

Set GPIO Mode allows the user to select between two (2) modes:



FIGURE 14. Single Keypanel – Channel 1 (LED 2 is solid)

1 Keypanel Mode (single-port mode) – All GPIOs are controlled by one (1) port. Associating the GPIO with one port allows you to access/address the GPIO in UPL Statements. Mode 3 is used to define the port to be used. The GPIO is associated with J1. This means that Port 0 has eight GPIO's mapped to it. Connected to J1 is a keypanel with the keypanel ID of 33 in AZedit.

To use the GPIO, you can create UPL statements. But be careful to assign the correct Output Action parameters:

RLY1 and OPT1 are Local GPIO 9 on the same keypanel
 RLY2 and OPT2 are Local GPIO 10 on the same keypanel



FIGURE 15. Single Keypanel – Channel 2 (LED 3 is solid)

All Keypanel Mode (multi-port mode) – Each port is associated with its corresponding GPIO. This means if keypanel 1 is connected to GPIO 1, it is associated with the corresponding GPIO port. GPIO1 and RLY1 are paired and assigned to the same panel. These cannot be split across devices.

When using this mode, an additional GPIO is available on each port.

RLY1 and OPT1 are represented in AZedit by Local GPIO 9 on the keypanel connected to J1

RLY2 and OPT2 are represented in AZedit by Local GPIO 9 on the keypanel connected to J2

To **configure the GPIO mode**, do the following:

1. Open **IPedit**.
2. From the left navigation, select the **OEI-2** unit you want to configure.
The Device Information Pane populates.
3. From the Mode drop down menu, select **All Keypanel** or **1 Keypanel**.

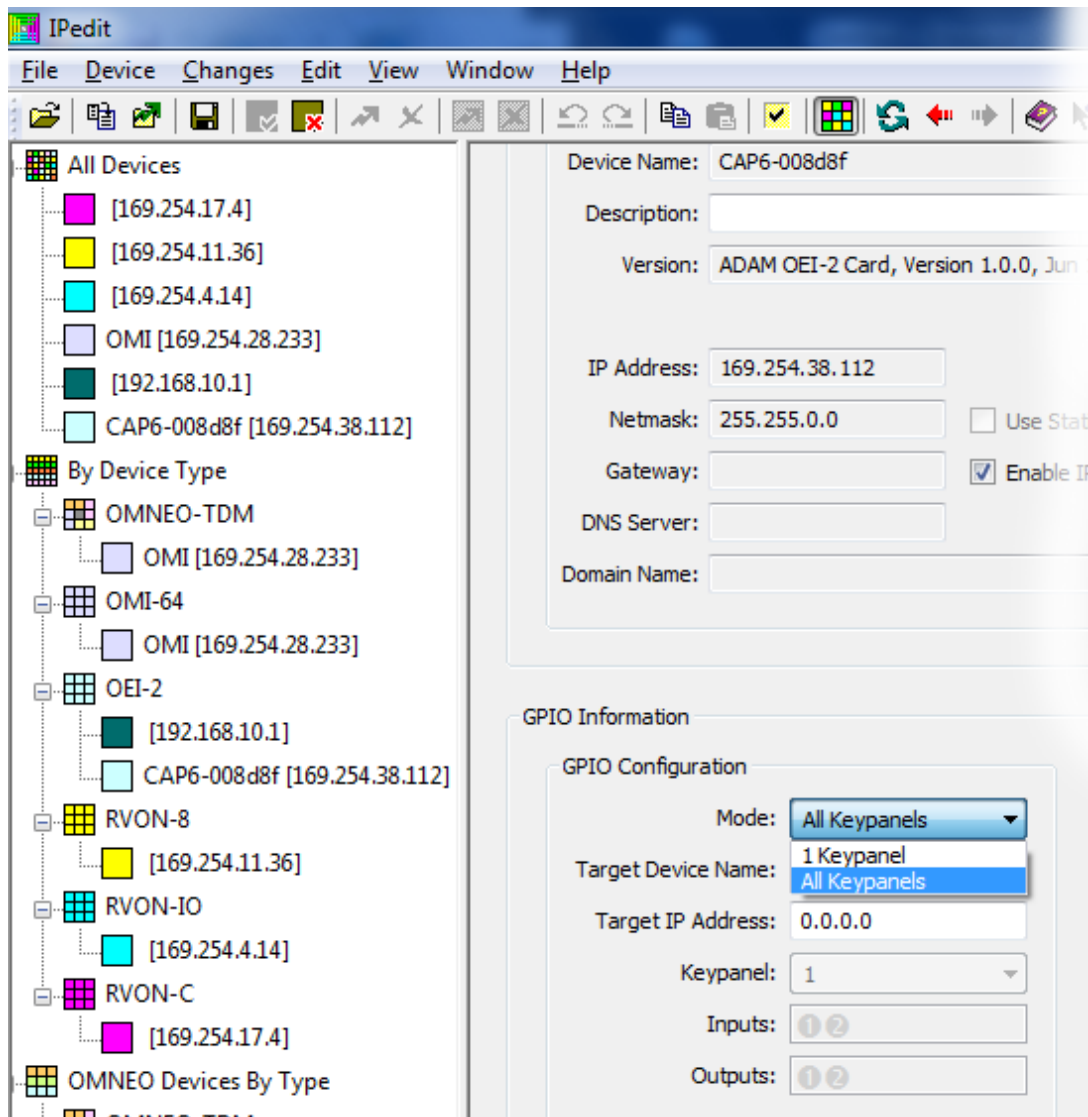

Mode 3 - Select Port for GPI

Select Port for GPIO Mode is used in conjunction with Mode 2. When *1 Keypanel Mode* is selected, the user can select the port the GPI/Os are assigned.

Reset Configuration

Reset Configuration Mode allows the user to reset all modes to the factory defaults. This also turns all the LEDs off.



FIGURE 16. Reset Configuration

To **reset the configuration from the front panel of the OEI-2**, do the following:

1. Using a straightened paperclip, press and hold the **MODE SEL** button for **six (6) seconds**.
All four (4) MODE LEDs start blinking.
2. Remove the **straightened paperclip** from the MODE SEL button.
The LEDs turn off. The OEI-2 is reset to Factory default.

IMPORTANT: If the MODE SEL button is held past eight (8) seconds the MODE LEDs stop flashing and show the existing MODE settings. This means the reset configuration did not occur.

Power On Reset

The **Power On Reset Mode** allows the user to cycle power to the OEI-2 unit.



FIGURE 17. Power On Reset

To **configure the Power On Reset mode from the front panel of the OEI-2**, do the following:

1. Using a straightened paperclip, press and hold the **MODE SEL** button for **10 seconds**.
The POWER and MODE LEDs start blinking.
2. Remove the **straightened paperclip** from the MODE SEL button.
The POWER LED turns off. The OEI-2 is configured for POWER ON Reset Mode.

IMPORTANT: If the MODE SEL button is held past 15 seconds the MODE LEDs stop flashing and show the existing MODE settings. This means the reset configuration did not occur.

Optional Power Supply Mount

Power Supply Rackmount Assembly Instructions

An optional power supply rackmount is available for purchase (P/N RP_OEI_PS_BRK), if needed.

To **mount the power supply rackmount assembly**, do the following:

1. Holding the rackmount assembly unit in the spot you want to mount it, make **guide marks**, using a marker, for the screw placement.

TIP: To make attaching the unit easier, pre-drilling the screw holes is suggested.

2. Using a screwdriver, attach the **rackmount assembly unit to the predefined mounting area** with the two (2) screws supplied.

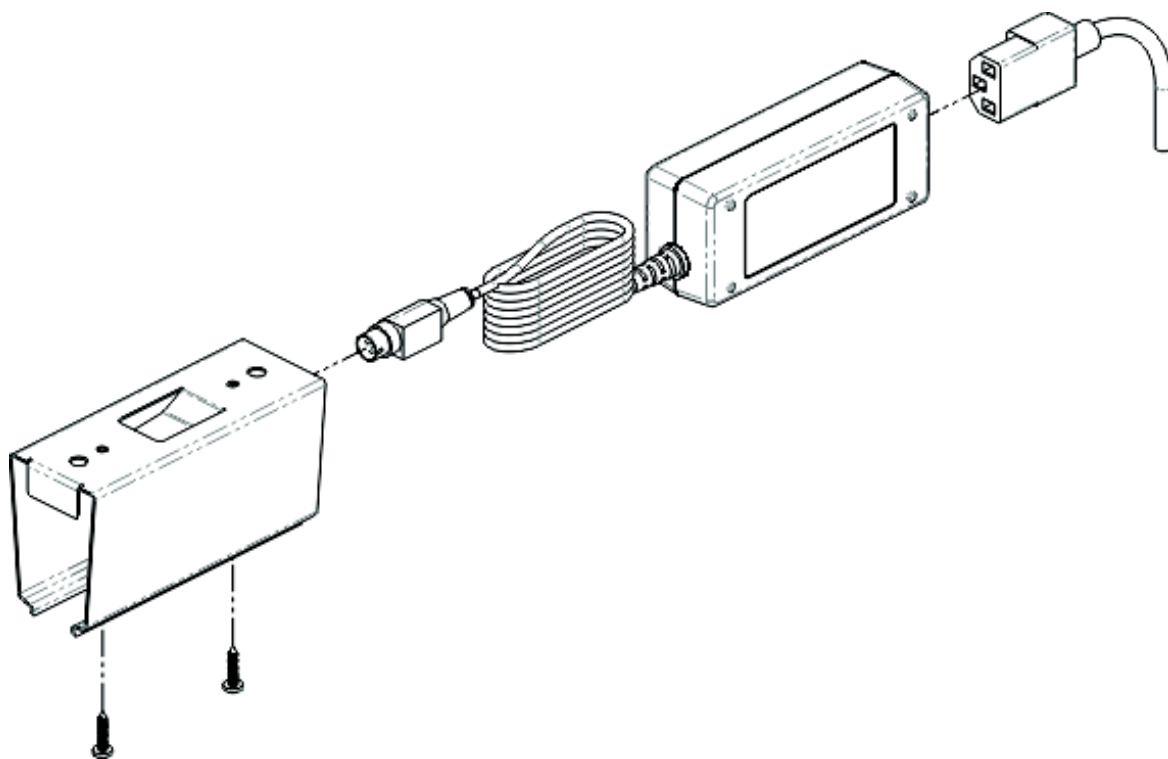

FIGURE 18. Power Supply Mounting Assembly

3. Carefully slide the **power supply** into the rackmount unit, as shown in Figure 18.

4. Attach the **power cord** to the power supply unit.

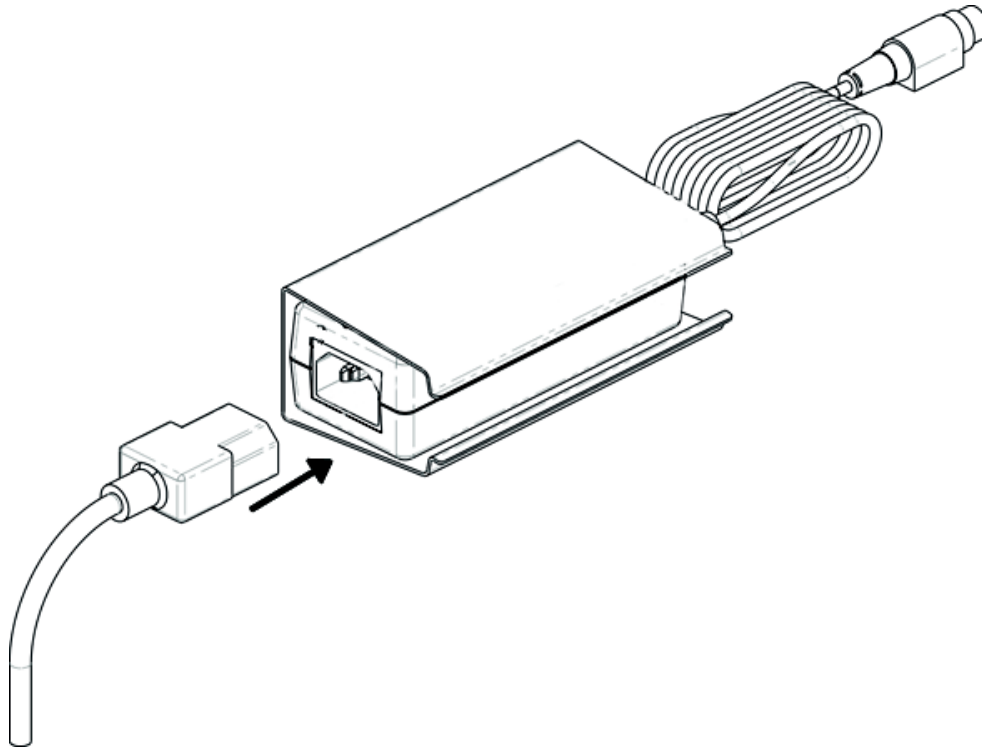

FIGURE 19. Attach Power Cord to Power Supply Unit

5. Attach the **other end of the power cord** to the power outlet.

NOTES

Bosch Security Systems, Inc.

12000 Portland Avenue South
Burnsville, MN 55337 U.S.A.
www.boschcommunications.com