

SEKONIC Color Meter

SPECTROMASTER C-700 C-700R Operating Manual



Please read the operating manual carefully to fully understand the features of this product before use and keep it for future use. Keep the operating manual in a safe place.





Congratulations on your purchase of a Sekonic SPECTROMASTER C-700/C-700R. Please read the operating manual carefully to properly utilize the many features and benefits of this precision instrument.

The Sekonic SPECTROMASTER C-700/C-700R is the first spectrometer that measures every light source (LED, HMI, Fluorescent and the natural light spectrum) PLUS wireless flash (C-700R only). In addition, with its CMOS linear image sensor, the SPECTROMASTER C-700/C-700R makes it possible to create output wavelength in 1 nm increments, capture spikes in light source output, especially fluorescent and LED lighting, and provide unmatched color measurement accuracy.

In addition, the "C-700/C-7000 Series Utility", included as an accessory of this product, can be used to save data, display measurement values and graphs, and perform settings when the meter is connected by USB to computers or tablets.

■ Safety Precautions

Before using this product, please read this "Safety Precautions" for proper operation.

 WARNING	The WARNING symbol indicates the possibility of death or serious injury if the product is not used properly.
 CAUTION	The CAUTION symbol indicates the possibility of minor to moderate personal injury or product damage if the product is not used properly.
 NOTICE	The NOTICE symbol indicates cautions or restrictions when using the product. Please read all notes to avoid errors in operation.
 NOTE	The reference symbol indicates additional information about the controls or related functions. Reading these is recommended.
	The arrow indicates reference pages.

WARNING

- Infants or toddlers may accidentally wrap the strap around their neck, so please place it in a location out of their reach. There is a danger of suffocation.
- Do not place batteries in open flames, attempt to short, disassemble or apply heat to them, use unspecified batteries, or recharge them (except rechargeable batteries). They may burst and cause fires, serious injury, or damage to the environment.

CAUTION

- Do not handle this product with wet hands, or leave it in the rain or in a location where it may be splashed with water, submerged, or come into contact with moisture. There is a danger of electric shock if the "Flash Light Cord (PC) Mode" is used.
This may also result in damage to the product.
- Do not attempt to disassemble the product for modification or parts replacement. It may affect measurement results or damage the meter.
- Do not attempt to play the included CD-ROM using an audio CD player. It may impair hearing or damage speakers and earphones.
- Gently tap the meter's LED panel when changing modes or making selections. Using pointed pens or pencils may scratch the LCD screen or damage the product.
- Infants or toddlers may accidentally grab the strap and swing the product, so please place it in a location out of their reach, as the meter may be damaged by impacts.
- Be careful that the neck strap does not come loose when carrying the product, as the meter may be damaged when dropped.
- This neck strap is made of polyester fiber.
Please refrain from using the product if synthetic fibers cause your skin to become irritated, inflamed or itchy in order to prevent worsening your symptoms.

■ Polyvinyl Chloride (PVC) cable and cord notice



WARNING

Handling the cord on this product or cords associated with accessories sold with this product will expose you to lead, a chemical known to the State of California to cause cancer, and birth defects or other reproductive harm. Wash hands after handling.

 **NOTICE**

- A protective sheet is attached to the LCD. Peel it off before use.
- Although the LCD monitor is manufactured to very high standards, it is possible to observe a few dead pixels on the screen. This is normal and not a malfunction of the meter.
- Do not use at altitudes above 2,000m (6,561 feet).
- Our company shall not be liable for any data loss caused by, but not limited to, malicious acts and control errors.
- You can install the software on the included CD-ROM only when you agree with all articles in the license agreement that comes with the CD-ROM.
- Be sure not to drop the meter or subject it to sudden impacts, as the meter will be damaged.
- Do not store the meter in areas of high temperature or high humidity, as the meter will be damaged.
- Be careful not to transport the meter from cold to warm moist conditions as condensation will form on the meter and may damage it.
- If the meter is operated in temperatures below -10°C , the response of the LCD will greatly slow down and the display may be difficult to view and read. This will not harm the meter. Also, if the temperature exceeds 50°C , the liquid crystal display will darken and become difficult to read, but when it returns to room temperature it will return to its normal condition.
- If the meter is left in direct sunlight, a vehicle, or near a heater, the unit's temperature will rise and may result in damage. Please be careful when using the meter in these types of locations.
- If the meter is left where corrosive gases may be generated, the gases may affect the product and may result in damage. Please be careful when using the meter in these types of locations.
- In case of disposing the meter, follow the rules of disposal in your area.

Maintenance Notes

- Be careful not to let the Light Receptor become dusty, dirty, or scratched as this may affect the precision of the measurement.
 - If the meter becomes dirty, wipe it with a dry, soft cloth. Never use organic solvents such as thinner or benzene.
-

 **NOTE**

- For used batteries, dispose of them according to the rules of your area, or bring them to a battery recycling shop near you.
 - Insulate plus and minus terminals with tape or other insulation material.
 - Do not disassemble the batteries.
-

■ Intended Usage

The meter is designed for:

- Measuring color temperatures and illuminance of natural or artificial lights for photographs, videos, and movies.
- Displaying the correction values of filters for camera or lighting to match to the target color temperature.
- Managing the lighting lamps' aging degradation by checking the color temperature.
- Managing the viewing light source by color temperature for printing color proof, digital/film production, etc.
- Check the quality of light source in color rendering index.

Main features of the C-700/C-700R

Model name	Usage	Features
C-700	Lighting control for still and motion capture	Controls ambient lights, flash lights and environment lights at shooting, and controls light sources as devices. <ul style="list-style-type: none"> • Correlated color temperature (Digital mode), Photographic color temperature (Film mode) (1,600K ~ 40,000K) • Illuminance measurement • Displayed in accordance with usage <ol style="list-style-type: none"> (1) Color temperature (2) LB/CC filter number (KODAK WRATTEN 2, LEE, FUJIFILM, ROSCO) (3) LB/CC index (4) CRI measurements (5) Spectral distribution graph display, graph display enlargement function (6) Illuminance/luminous exposure (ambient light/flash light) (7) Color deviation (Δuv) • White balance function
C-700R	Lighting control for still and motion capture	<ul style="list-style-type: none"> • Radio transmission function to trigger PocketWizard® Brand radios using 340-354Mhz (FCC models) or 433MHz (CE models).



NOTE

The C-700R is designed so that it complies with technical standards for human body absorption of electromagnetic waves established by the Japanese government *1 and electromagnetic wave protection tolerance that the international guideline recommends. These international guidelines were established by the International Commission on Non-ionizing Radiation Protection (ICNIRP) in cooperation with the World Health Organization (WHO). The tolerance includes a sufficient safety margin regardless of the user's age or health conditions.

*1 The technical standard is stipulated in the Ministerial Ordinances Related to Radio Law (Ordinance Regulating Radio Equipment Article 14.2).

■ Intended Users

The intended users of this product are the following.

Those who are engaged in shooting or related businesses, such as photographers, videographers, and cinematographers, light operators, gaffers and directors of photography.

In addition, lighting engineers of architecture, art, and interior, and those who manage light sources in rental studios and light shops.

■ Restrictions

There are some cautions and restrictions regarding the use of this product. Please read and understand the following before using the meter.



NOTE

- The operation of this meter may change without prior notice due to specification changes or other reasons. Therefore, the contents of this operating manual may differ from actual operation of the meter. Please visit www.sekonic.com for the latest information.
- Cautions regarding safety such as the Usage Precautions and the Safety Precautions comply with the legal and industrial standards at the time of the making of this operating manual. Therefore, the described contents may not comply with current precautions. Please visit www.sekionic.com for the latest version of the instruction manual.
- The product may contain printing material such as cautions related to safety and printing errors as a supplement to the operating manual.
- The contents of this operating manual may be reproduced for non-commercial purposes and for personal use only. However, the reproduced material must contain the copyright notice of our company.
- The screens in this operating manual may differ from the actual displays of the meter you are using. (Colors, letters, etc.)

■ Accompanying Accessories

The following items are included with the SPECTROMASTER C-700/C-700R. Confirm if any accessories are missing after unpacking.

If something is missing, contact the sales agent.

Batteries (size AA) and a USB cable are not included.

Neck Strap



Quick Guide



Soft Case

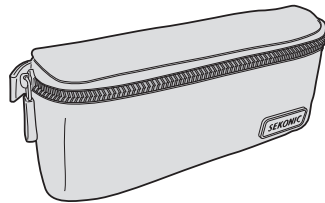

Safety Precaution

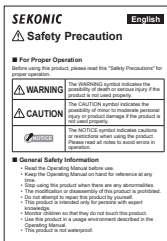

CD-ROM (Operating Manual, C-700 Series Utility)

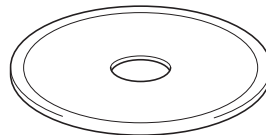

Table of Contents

■ Safety Precautions	i
■ Polyvinyl Chloride (PVC) cable and cord notice	iii
■ Intended Usage	v
■ Intended Users	vi
■ Restrictions	vi
■ Accompanying Accessories	vii
1. Parts Designations and Functions	1
■ 1-1 Parts Designations	1
■ 1-2 Parts Functions	2
2. Before Use	3
■ 2-1 Attaching the Strap	3
■ 2-2 Installing the Batteries	4
■ 2-3 Power ON/OFF	5
■ 2-4 Checking the Battery Capacity	9
■ 2-5 Automatic Power OFF Function	10
■ 2-6 Changing Batteries During Measurement	11
3. Basic Operation Methods	12
■ 3-1 Basic Operation Flow	12
■ 3-2 Screen and Operation	14
■ 3-2-1 Basic Screen and Operation	14
■ 3-2-2 Icon Operation	18
■ 3-2-3 Input of Numbers/Characters	19
■ 3-2-4 Locking and Unlocking the Screen	21
4. Setting the Measuring Conditions	22
■ 4-1 Selecting the Measuring Mode	22
■ 4-1-1 Matching Measuring Mode with Light Sources	22
■ 4-1-2 Selecting the Shutter Speed (Flash Modes Only)	24
■ 4-2 Setting the Indication and Items in Measurement Screen	26
■ 4-2-1 Setting Target Color Temperature	26
■ 4-2-2 Customizing Measuring Displays	28

4-3	Selecting the Display Mode	29
4-3-1	Displaying in Text [Text] Mode	33
4-3-2	Displaying in Spectrum Graph [Spectrum] Mode	36
4-3-3	Displaying in Spectrum Comparison [Spectrum Comp.] Mode	38
4-3-4	Displaying in Color Rendering Index [CRI] Mode	43
4-3-5	Displaying in Camera Filter [Camera Filter] Mode	45
4-3-6	Displaying in Lighting Filter [Lighting Filter] Mode	48
4-3-7	Displaying to Compare Light Sources [Multi Lights] Mode	51
4-3-8	Displaying in White Balance Correction Graph [WB Corr.] Mode	57
4-3-9	Displaying Setting [Setting] Screen	59
5.	Measuring Light Sources [Measurement Screen]	61
5-1	Measurement Method	61
5-1-1	Balancing Color Temperatures of Light Sources	61
5-2	Measurement in Ambient Light Mode	62
5-3	Measurement in Cordless Flash Mode	66
5-4	Measurement in Cord (PC) Flash Mode	71
5-5	Measurement in Radio Triggering Flash Mode (C-700R Only)	77
5-5-1	Measurement Method	79
5-5-2	Setting the Radio Channel	80
5-6	Contrast Function (in Ambient Light Mode only)	86
5-7	When [Over], [Under] or [Filter N/A] is Displayed	88
5-7-1	Display of [Over], [Under] or [Filter N/A]	88
5-7-2	Changing the Light Range	90
6.	Measurement Tool [Tool Box] Screen	91
6-1	Selecting Digital/Film	92
6-2	Setting Preset Contents [Preset Selection] Screen	94
6-3	Using the Memory Function	97
6-3-1	Naming Measurement Being Memorized [Memory Title] Screen	98
6-3-2	Recalling Measurement Results [Memory Recall] Screen	101
6-3-3	Renaming Memory Title [Memory Rename] Screen	107
6-3-4	Deleting Saved Measurement Results [Memory Clear] Screen	110
6-4	Setting the Radio Channel (C-700R Only)	115

7. Meter Settings [Setting] Screen	122
7-1 Setting Items	122
7-1-1 Item List	124
7-2 Customize	125
7-2-1 Item Specifications	126
7-2-2 Selecting the Shutter Speed Step	127
7-2-3 Selecting the LB Step	130
7-2-4 Selecting the Camera Filter Brand	132
7-2-5 Selecting the Lighting Filter Brand	134
7-2-6 Selecting the White Balance Step	136
7-2-7 Selecting the Unit of Illuminance	138
7-2-8 Selecting the Spectrum Y-axis Scale	140
7-2-9 Selecting the Auto Power Off Time	143
7-2-10 Selecting the Backlight Brightness	145
7-2-11 Selecting the Auto Dimmer Time	147
7-2-12 Selecting the Language	149
7-2-13 Selecting the Radio System Preference (C-700R Only)	151
7-2-14 Reset Customized Items	153
7-3 Preset Editing	154
7-3-1 Displaying the Preset Selection List	157
7-3-2 Setting the Present Name	159
7-3-3 Setting the Preset Target Color Temperature	161
7-3-4 Setting the LB Index Correction Value	164
7-3-5 Setting the CC Index Correction Value	166
7-4 Dark Calibration	168
7-5 Product Information Display	171
7-5-1 Regulation Display	173
8. Hardware Setting Screen	174
8-1 Adjust Touch Panel	176
8-2 Edit User Information	179
8-3 Factory Setting	181

9. Appendix	184
9-1 Glossary	184
9-2 Filter Types	186
9-3 Specifications	191
9-4 Legal Requirement	195
10. Optional Accessories	196
11. Troubleshooting	197

1. Parts Designations and Functions

1-1 Parts Designations

Front View

Rear View

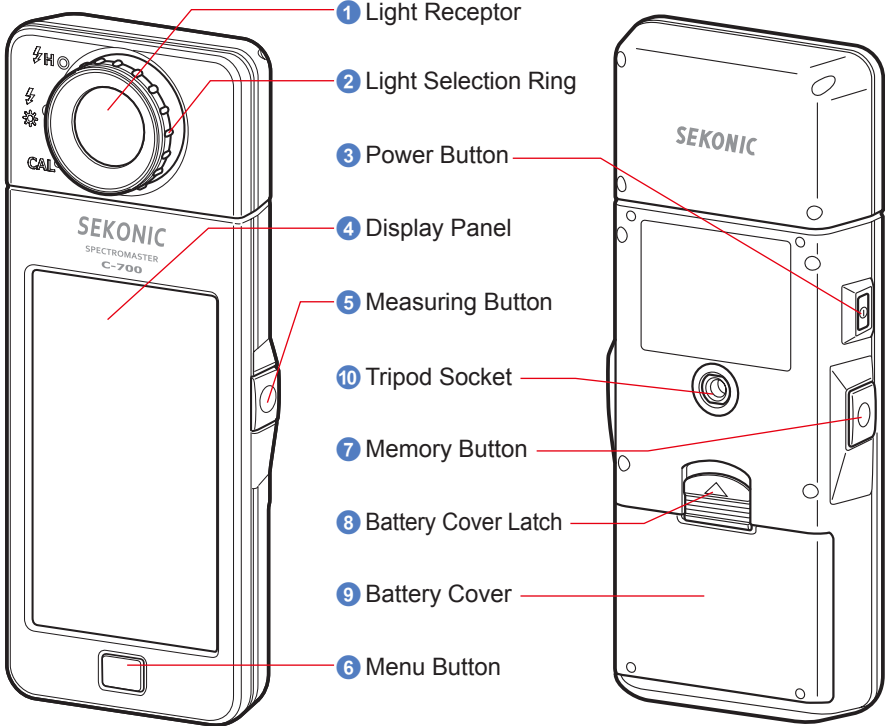

Bottom View

Battery Compartment Section

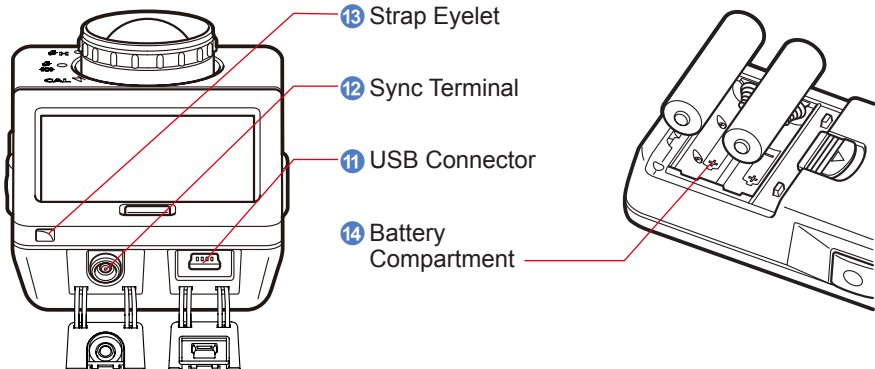

1-2 Parts Functions

The following table lists the functions of each part.

No.	Part Name	Functions
1	Light Receptor	Point light receptor directly at light source during reading. Head rotates 270 degrees to aid reading.
2	Light Selection Ring	Rotate to select dark calibration, normal measuring range or high range for flash light.
3	Power Button	Press to turn ON/OFF.
4	Display Panel	Displays the setting screens and measurement screens. The built-in touch panel function enables setting, selection or operation by touching the displayed screens. (➡ P18)
5	Measuring Button	Press for measurement.
6	Menu Button	Press to shift display to Display Mode Selection screen.
7	Memory Button	Press after measuring to record the measured data.
8	Battery Cover Latch	Latch for the battery cover.
9	Battery Cover	Secures the batteries.
10	Tripod Socket	Female mounting threads (1/4-20) for hands free mounting on tripods.
11	USB Connector	The USB connector for connecting to the PC with the installed application and USB bus power. USB terminal: Mini-B-5pin
12	Sync Terminal	Accepts an optional synchro cord when using meter in Cord (PC) Flash Mode.
13	Strap Eyelet	Used to attach the included strap.
14	Battery Compartment	Holds the batteries. Insert the batteries in the correct direction.

2. Before Use

2-1 Attaching the Strap

1. Pass the strap (included) through the outer hole of the Strap Eyelet **13**.
2. Pass the opposite end of the strap through the loop at the end of the strap.

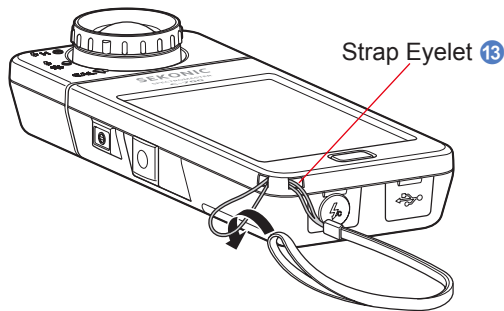

WARNING

Infants or toddlers may accidentally wrap the strap around their neck, so please place it in a location out of their reach. There is a danger of suffocation.

CAUTION

- Infants or toddlers may accidentally grab the strap and swing the product, so please place it in a location out of their reach, as the meter may be damaged by impacts.
- Be careful that the neck strap does not come loose when carrying the product, as the meter may be damaged when dropped.
- This neck strap is made of polyester fiber. Please refrain from using the product if synthetic fibers cause your skin to become irritated, inflamed or itchy in order to prevent worsening your symptoms.

2-2 Installing the Batteries

1. Prepare two AA batteries.
2. Slide the Battery Cover Latch **8** in the direction of the arrow and remove the Battery Cover **9**.
3. Insert the batteries according to the "+" and "-" symbols in the Battery Compartment **14**.
* As shown in the diagram below, please note both positive sides of the batteries are facing in the same direction.
4. While lining up the two tabs on the Battery Cover **9**, press the Battery Cover **9** back into place from above.

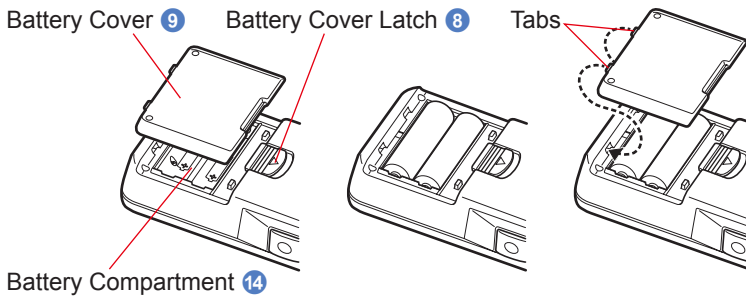

WARNING

Do not place batteries in open flames, attempt to short, disassemble, apply heat to, or recharge them (except rechargeable batteries). They may burst and cause fires, serious injury, or damage to the environment.



CAUTION

- Please insert the batteries minus "-" side first.
When removing the batteries, remove them plus "+" side first.
- Do not use batteries with any other rating than the one specified.
Also, do not mix old and new batteries.
- If the meter will not be used for an extended period of time, it is recommended to remove the batteries to avoid possible damage caused by battery leaking.

2-3 Power ON/OFF

Power ON

1. Turn the Light Selection Ring ② to set to the dark calibration position CAL ().
2. Press the Power Button ③.
The meter will turn on and the Opening screen will be displayed (for 2 seconds).

Light Selection Ring ②

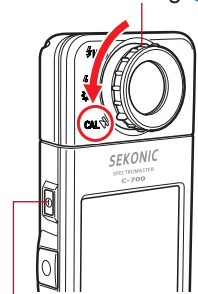

Power Button ③

C-700 Opening Screen



C-700R Opening Screen



NOTICE

- The blue lettered "SEKONIC" logo screen is displayed after battery replacement and 24 hours after power OFF.
- Movement of the blue status bar indicates that the meter is checking its memory and preparing to operate. Do not turn the power OFF. Otherwise, the meter may be damaged.

Logo Screen



3. Select the language. (Appears only when turned ON for the first time)

The Language Selection screen is displayed. Select the language to use.

Language Selection Screen



Language Selection Confirmation Screen



A blue highlight will appear behind the selected button.

4. Press the [OK] to select the language.

The language can be switched at any time. (➔ P149)

5. Dark calibration.

The C-700 series measuring system must be calibrated before use. Turn Light Selection Ring to calibration indication. "Dark calibration in progress. Please wait" and the status bar will appear while calibrating. The measurement screen will appear when operational.

Dark Calibration Process Screen

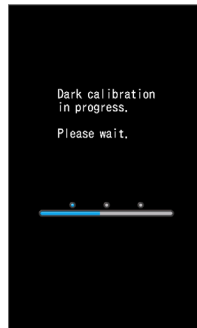

Dark calibration is performed when new batteries are used, 24 hours passed since last use or there is a big change in temperature between turning power OFF and ON. Except the cases above, dark calibration after power ON is skipped.

NOTICE

- When the Light Selection Ring ② is not set to the dark calibration position, the message "Please set Light Selection Ring for dark calibration." is displayed. Set the Light Selection Ring ② to the dark calibration position CAL () to calibrate the system.

Dark Calibration Position Confirmation Screen





- If dark calibration is not successful, "Dark calibration failed. Please check Light Selection Ring position." is displayed. Set the Light Selection Ring ② to the dark calibration position CAL () to calibrate the system.





Dark Calibration Confirmation Screen



6. Press the Measuring Button ⑤ to measure.

Turn the Light Selection Ring ② to select the range.

When measuring ambient light, make sure to select Range L  ().

When measuring flash units, select Range L  () or Range H  () depending on the brightness of of the flash. (➔ P88, ➔ P90)

NOTICE

When the Measuring Button ⑤ is pressed at the dark calibration position, the message "Measurement failed. Please check Light Selection Ring position." is displayed. Set the Light Selection Ring ② to the correct position and the Measurement screen will be displayed.



**NOTE**

Measurements and display will take longer in light levels below 30lx. The LCD illumination will normally switch off during measurements to avoid influence to measurements.

Power OFF

1. Press and hold the Power Button **3** for 1 second or longer.

The meter will turn OFF.

**NOTICE**

Please wait 3 seconds between repeated power on and power off sessions.

**NOTE**

- If the LCD screen shows no display, check if the batteries are installed properly (Pos/Neg positioning) and have enough capacity.
- All settings and measurements made during use are saved in memory even after the meter is powered off.

2-4 Checking the Battery Capacity

When the power is turned ON, the LCD screen will show the battery capacity indicator.



Sufficient battery life remaining.



Adequate battery life remaining.



Have a spare battery ready.



Replace the battery immediately.

Battery capacity indicator

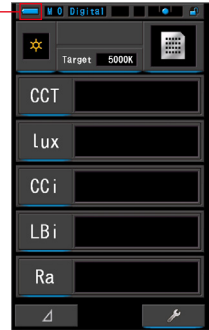

NOTE

- When battery power is low and the meter is turned ON, the LCD screen will appear and then turn off immediately. This is an indication that the batteries are depleted and should be replaced immediately.
Having spare batteries on hand is recommended.
- When the meter is continuously used at room temperature, the battery life should last 8 hours (based on Sekonic testing methods).

2-5 Automatic Power OFF Function

To save battery capacity, the meter will automatically turn off 20 minutes after the last button is pressed.

NOTE

- All measurements, settings and indications are saved in memory even after the meter has automatically turned off. When the power is turned ON, they will be displayed again.
- The automatic power off time setting can be selected according to your needs in the settings. (► P143)
- If, while in transport, the Power Button ③ is inadvertently and continually pressed in, the meter will turn ON for about 1 minute and then turn automatically turn OFF to save battery power.

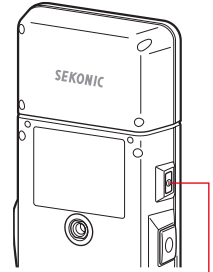

Power Button ③

2-6**Changing Batteries During Measurement**

- Please make sure the power is OFF when replacing batteries. If left ON, the meter circuit could be damaged and measurements taken during the last operation will not be saved.
- If an unexpected display appears on the LCD during battery replacement or measurement, ie. settings other than selected, or if the meter does not respond when a button is pressed, remove the batteries, wait at least 10 seconds, and then re-install them.

3. Basic Operation Methods

3-1 Basic Operation Flow

The basic operations and screens are as follows. Measurements and measurement changes are operated from the Measurement screen.

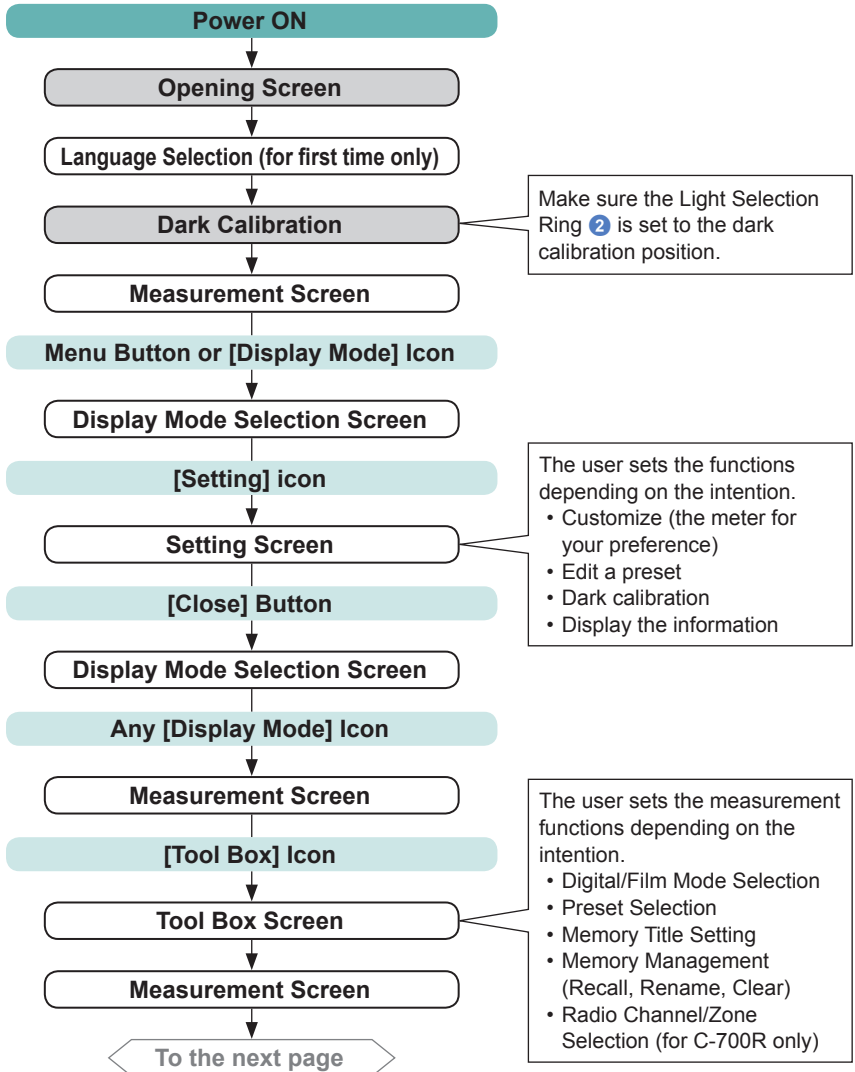

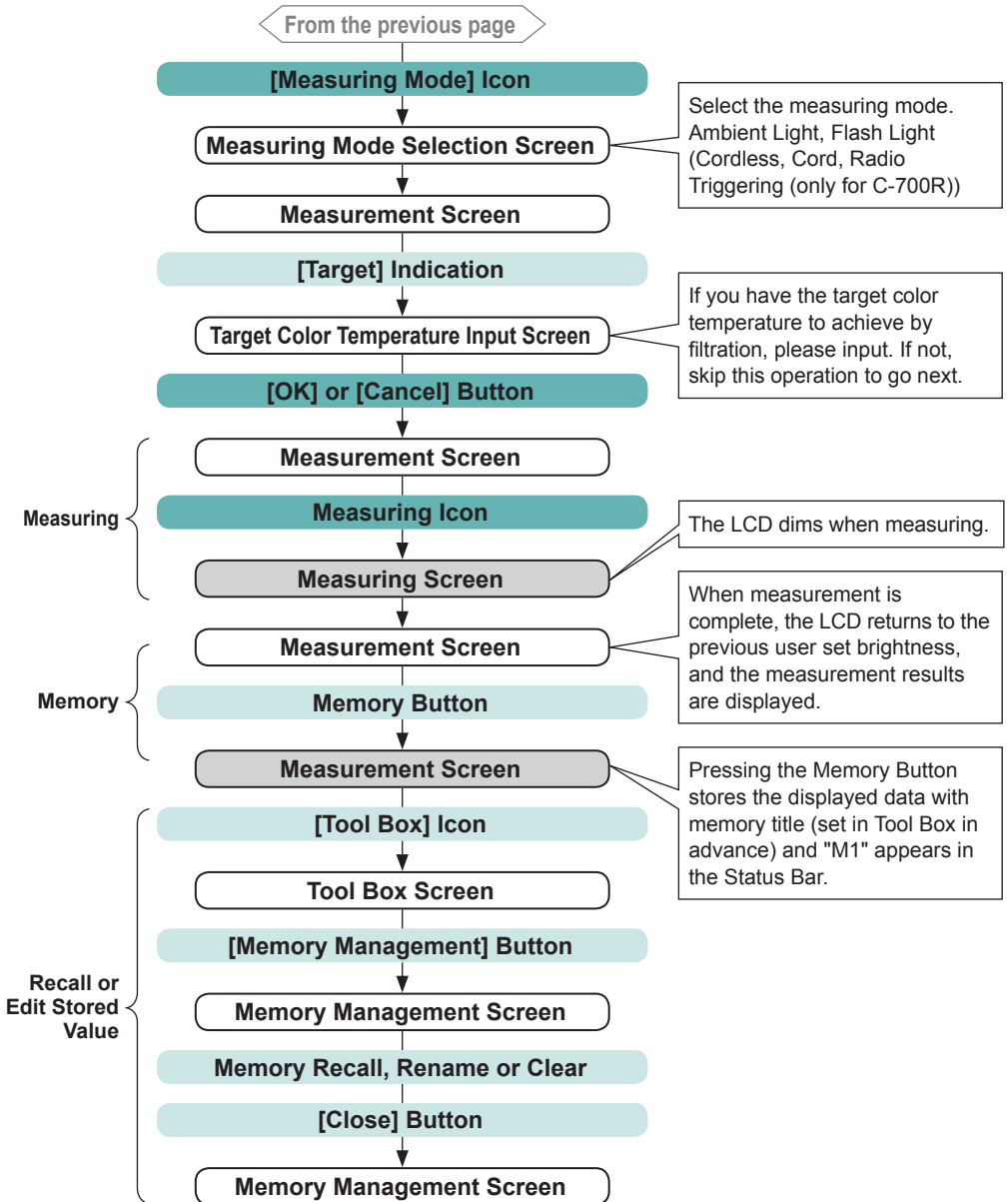

3-2 Screen and Operation

3-2-1 Basic Screen and Operation

The touch-screen display enables selecting Display Modes and settings with the touch of your finger.

Measurement Screen

The Measurement screen is displayed after the meter is turned ON and the dark calibration is complete.

Measurements can be made in the Text, Spectrum, Spectrum Comparison, CRI and Camera and Lens Filter and White Balance Correction modes. For details of Display Modes, please refer to "4-3 Selecting the Display Mode" (→ P29).

* Pressing the Menu Button **6** returns the meter to the Display Mode Selection screen.



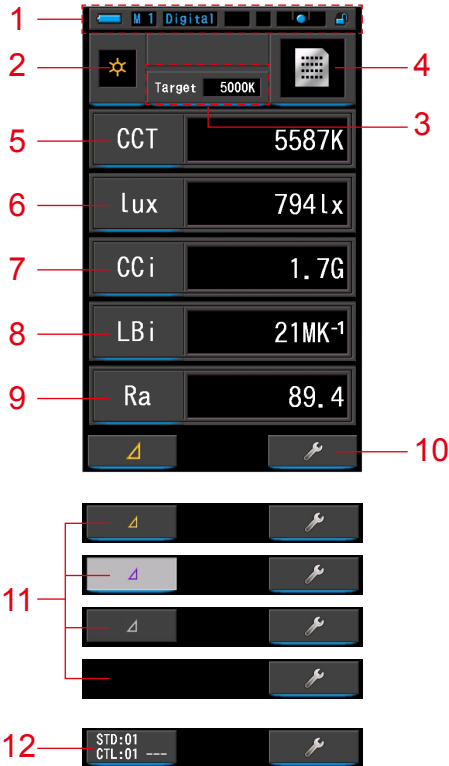

Measuring Screen in Text Mode

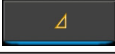
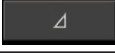

* The display changes depending on the set measuring mode.

* For this description, all icons and menus are displayed.

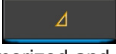
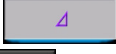
Item List

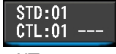
No.	Part Name	Description
1	Status Bar	Displays the setting contents. (➔ P16)
2	[Measuring Mode] Icon	Displays the measuring mode. (➔ P22) Switches to the Measuring Mode Selection screen.
3	[Target] Indication	Displays the reference color temperature. (➔ P26) Switches to the Target Color Temperature Input screen.
4	[Display Mode] Icon	Displays the display mode. (➔ P29) Switches to the Display Mode Selection screen.
5 ~ 9	[Display Item] Indication	Switches to the Item Selection screen. (➔ P28)
10	[Tool Box] Icon	Switches to the Tool Box screen. (➔ P91)
11	[Delta] Icon (in Ambient Light Mode only)	 Displayed when differential measurement can be performed.
		 When there is no reference measurement value, the icon is disabled.
		 When differential measurement cannot be performed, the (Δ) icon is not displayed.
		When  is touched, the displayed measurement is memorized and Contrast Function is activated. When holding the Measuring Button 5 , the value differences of the memorized items (except filter names) and the current reading will be displayed. When the Measuring Button 5 is released, the display will revert to memorized values of the first reading. (A graph displays the reference values) When  is touched, the icon returns to  and the values measured last are displayed. Contrast Function is cancelled when the power is turned OFF. Note Caution: When the Contrast Function icon is displayed, the Memory Button 7 is disabled.
12	[Channel Zone] Icon (C-700R in Radio Triggering Mode only)	When  is touched, it switches to the Radio Channel/Zone screen. (➔ P115)



NOTE

When values are outside the display or measurement range, [Under], [Over] or [Filter N/A] is displayed.

Under: Displayed if value is lower than measurement range (too dark) or color temperature value is too low.







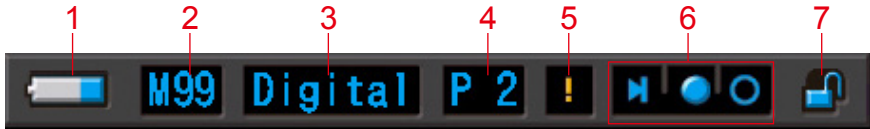







Over: Displayed if value is higher than measurement range (too bright) or color temperature value is too high.

Filter N/A: Displayed if there is no more combination of Filter name and number.

Status Bar



* For this description, all icons and menus are displayed.

No.	Part Name	Description	
1	Battery Capacity Indicator		Sufficient battery life remaining.
			Adequate battery life remaining.
			Have a spare battery ready.
			Replace the battery immediately.
			Appears when powered by USB.
2	Memory Count		Displays the number of measured data stored in memory. The number in memory is displayed until 99 to the right of the mark.
3	Digital/Film Mode		Displayed when in Digital Mode.
			Displayed when in Film Mode.
4	Preset Selection		Displays the preset number when a preset is selected.
5	Temperature Fluctuation Warning		When the mark appears, the color temperature reference is fluctuating, and accurate measurement may not be possible. Please perform dark calibration.
6	Light Selection Ring Status Indicator		Appears when the Light Selection Ring ② is selected by the dark calibration position.
			Appears when the Light Selection Ring ② has range "L" selected.
			Appears when the Light Selection Ring ② has range "H" selected.
7	Key Lock Status Indicator		Appears when the screen is unlocked.
			Appears when the screen is locked. When the screen is locked, touch panel operations are disabled.

Tool Box Screen

The following setting can be performed after touching the [Tool Box ()] icon on the measuring screen.

* All icons are displayed for explanatory purposes for the Tool Box screen. It is not the default.

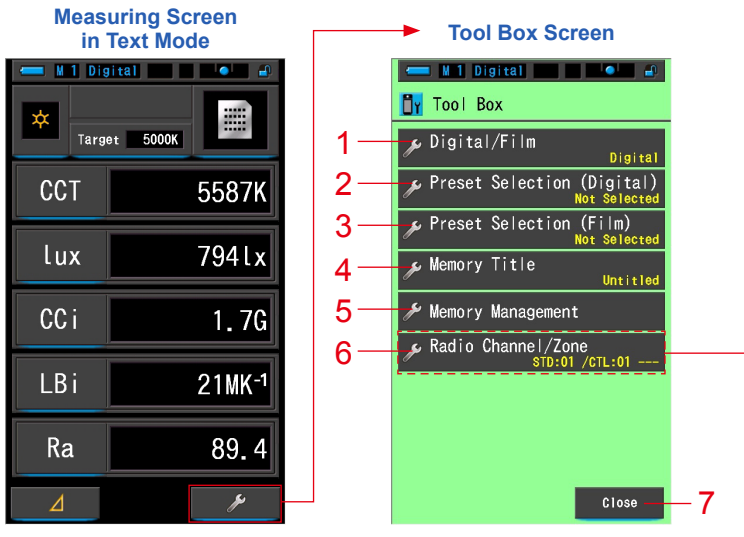

*Indicated only for C-700R model

[Tool Box: Item List]

No.	Part Name	Description
1	Digital/Film	Switches to the Digital/Film screen. (➔ P92)
2	Preset Selection (Digital)	Switches to the Preset Selection screen. (➔ P94)
3	Preset Selection (Film)	Switches to the Preset Selection screen. (➔ P94)
4	Memory Title	Switches to the Memory Title Input screen. (➔ P98)
5	Memory Management	Switches to the Memory Management screen. (➔ P101)
6	Radio Channel/Zone (only for C-700R model)	Switches to the Radio Channel/Zone screen. (➔ P115)
7	[Close] Button	Closes the Tool Box screen and returns to the Measurement screen.

3-2-2 Icon Operation

Touch operation

Touch the icons on screen to perform various operations.

(Ex.) Measuring Screen in Text Mode

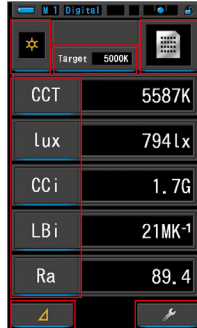

Touch-enabled Icons

A blue illumination under icons indicates which icons are operational.



Touch-enabled Icons



Touch-disabled Icons

Slide Operation

Slide your finger tip up or down over a value to change the value amount. Sliding your finger over scroll bar provides fast navigation of large menus.

(Ex.) Shutter Speed Selection Screen

Scroll Selection

Slide a finger up or down on the setting value areas to change setting values.

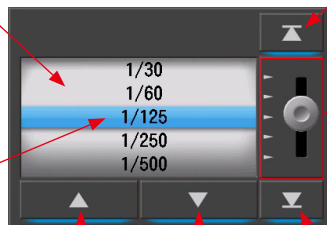

Top Icon

Touch to advance to the lowest value.

Scroll Bar

Touch and slide up or down to scroll settings.

One Step Icon

Touch the Up or Down icon to advance one position.

Bottom Icon

Touch to advance to the highest value.

* Blue bar indicates the value selected.

3-2-3 Input of Numbers/Characters

You can input numbers and characters.

Numeric Number Input Screen

(Ex.) Target Color Temperature (Digital) Display

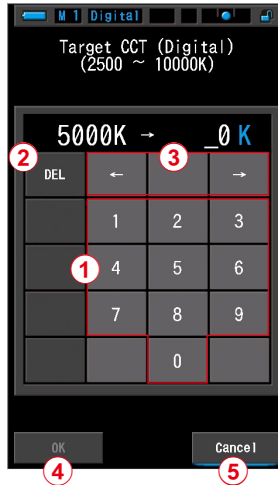

Numeric Number Method

No.	Key	Description
①	0-9	Value displayed on screen when key touched.
②	Delete	Deletes input value at cursor position.
③	← →	Moves input position.
④	OK	Confirms input value and returns to previous screen.
⑤	Cancel	Cancels input value and returns to previous screen.

Character Input Screen

Figure Input Screen

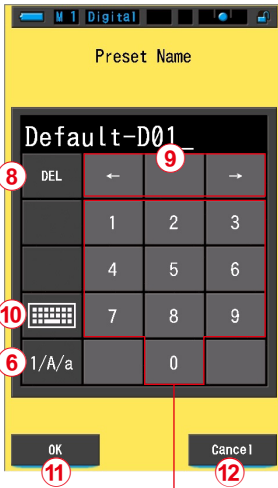

⑦ (Figures)

Upper Case Input Screen

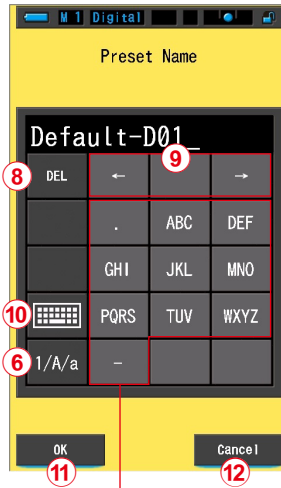

⑦ (Upper Case Letters)

Lower Case Input Screen

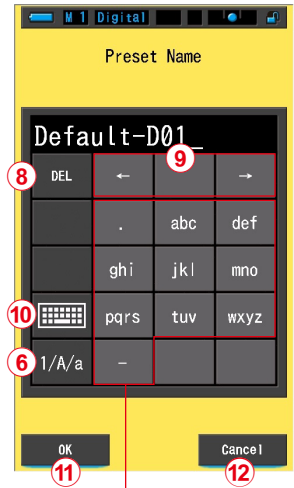

⑦ (Lower Case Letters)

Keypad (Upper Case Input Screen)

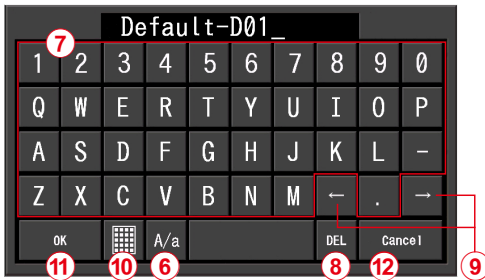

Keypad (Lower Case Input Screen)

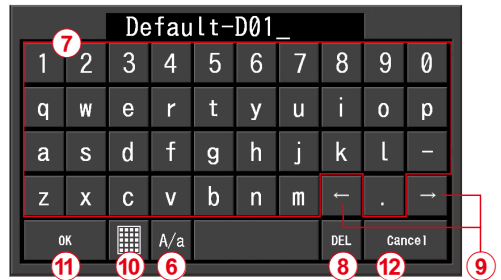

Input Method of Characters and Numbers

No.	Key	Description
⑥	1/A/a	Shifts between numbers/upper case letters/lower case letters.
⑦	0-9, ABC, abc, hyphen, period	Value displayed on screen when key touched. Repeated touching of the same button for alphabet (ABC/abc) will change the alphabet character in order.
⑧	Delete	Deletes the character at the cursored position.
⑨	← →	Moves input position.
⑩	Keypad	Shifts between Standard Keypad and Qwerty Keypad.
⑪	OK	Confirms input value and returns to previous screen.
⑫	Cancel	Cancels inputting and returns to previous screen.

3-2-4 Locking and Unlocking the Screen

You can lock the screen to prevent misoperation.

When the screen is locked, touch operation is disabled.

However, the Memory Button **7**, Measuring Button **5**, and Power Button **3** are still operational.

The screen will stay locked even when power is turned OFF and ON.

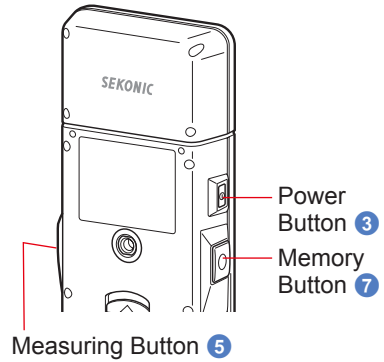

To Lock

In any measuring mode, press and hold the Menu Button **6** to see the Locked icon [] appear at the upper right corner of the LCD screen.

Function Icons cannot be operated while the screen is locked.



The Locked icon [] will appear for approximately 1 second at the center of the screen when function icons are touched or MENU button **6** is pressed.

* This lock function can be set in the Measuring screens only.

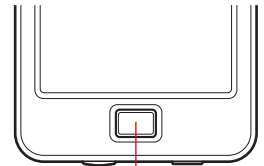

Menu Button **6**

To Unlock

When the Menu Button **6** is pressed and held again, the screen is unlocked.

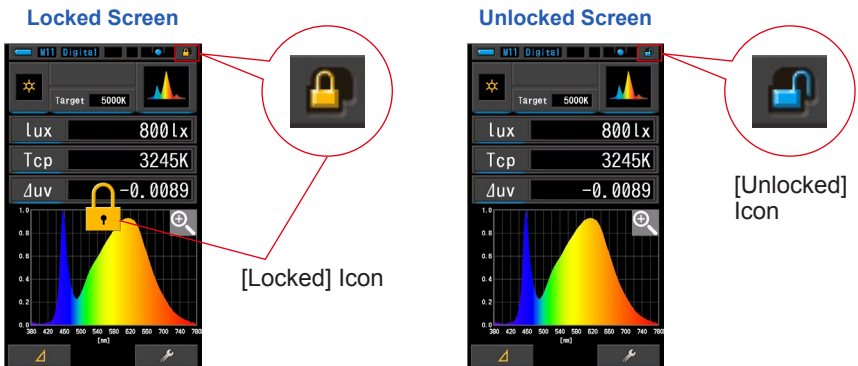

4. Setting the Measuring Conditions

4-1 Selecting the Measuring Mode

4-1-1 Matching Measuring Mode with Light Sources





Select the Measuring Mode to use.

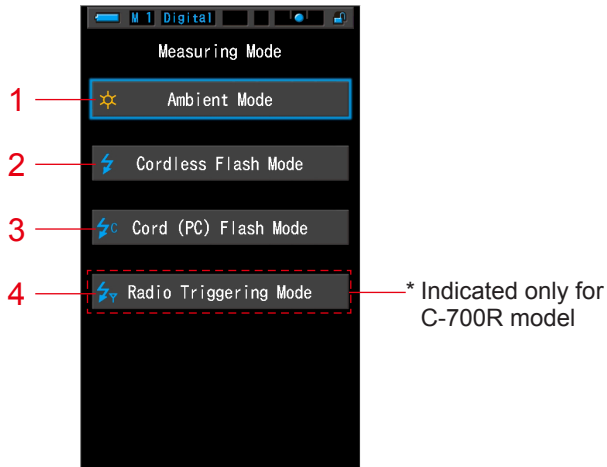

If you change measuring mode settings, the measurement data will be erased.

Measuring Mode Selection Screen



No.	Measuring Mode	Icon	Description
1	Ambient Light Mode		Measures continuous light such as sunlight, tungsten, fluorescent, and LED lights. (➔ P62)
2	Cordless Flash Mode		Detects flash color temperature without meter-flash connection after Measuring Button pressed to arm meter (for 90 seconds) and flash fired separately. Measure using a flash during the wait time. (➔ P66)
3	Cord (PC) Flash Mode		Detects flash color temperature with PC (synchro) cord meter-flash connection. (➔ P71)
4	Radio Triggering Flash Mode (only for C-700R model)		Detects flash color temperature without meter-flash connection after radio transmitted signal is received by radio-receiver connected flash. (➔ P77)

Operation

1. Touch the [Measuring Mode] icon in the upper left corner of the screen.
The Measuring Mode Selection screen will be displayed.

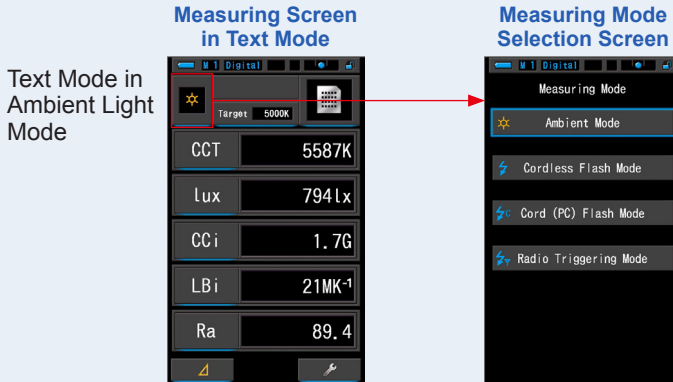

2. Touch an icon to select the measuring mode.

Select the desired measuring mode.

Making selection returns the display to previous measuring screen using selected mode.

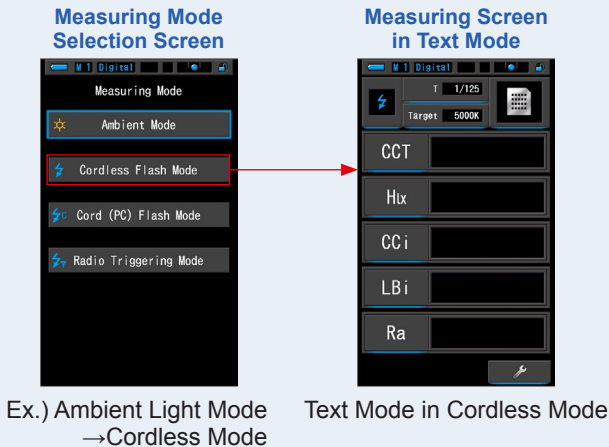

NOTE

- Ambient light includes continuous light sources such as natural light (sunlight), tungsten lamps, fluorescent lamps, LED lights, etc.
- Flash light includes brief and intense burst of light sources such as electronic flash units or flash bulbs.

4-1-2 Selecting the Shutter Speed (Flash Modes Only)

Set a shutter speed that is appropriate for the intended flash-ambient measurement.

Operation

1. Touch the [T (Shutter Speed)] indication.

Measuring Screen in Text Mode

Text Mode in
Cordless Mode

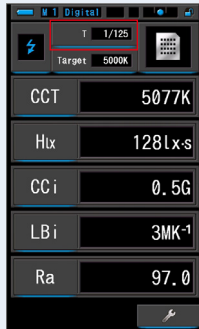

2. Select the desired shutter speed.

Shutter Speed Screen

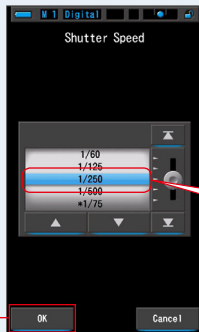

[OK] Button

[Shutter Speed 1/125]



[Shutter Speed 1/250]

3. Touch the [OK] button.

Confirms the settings, and returns to the previous Measurement screen.

Touch [Cancel] to return to the previous measurement screen without setting speed.

The shutter speed is set.

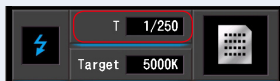

NOTE

Shutter speeds can be selected by the item [Shutter Speed Step] in page 1 of Setting. You can choose 1 step, 1/3 step, and 1/2 steps. (► P127)

Shutter Speed Options

1 Step (Factory default)	1/3 Step	1/2 Step	1 Step (Factory default)	1/3 Step	1/2 Step
1s	1s	1s		1/50	1/350
1/2	0.8	0.7		1/60	1/500
1/4	0.6	1/2		1/80	*1/75
1/8	0.5	1/3		1/100	*1/80
1/15	0.4	1/4		1/125	*1/90
1/30	0.3	1/6		1/160	*1/100
1/60	1/4	1/8		1/200	*1/200
1/125	1/5	1/10		1/250	*1/400
1/250	1/6	1/15		1/320	
1/500	1/8	1/20		1/400	
*1/75	1/10	1/30		1/500	
*1/80	1/13	1/45		*1/75	
*1/90	1/15	1/60		*1/80	
*1/100	1/20	1/90		*1/90	
*1/200	1/25	1/125		*1/100	
*1/400	1/30	1/180		*1/200	
	1/40	1/250		*1/400	

* Special shutter speed setting.

NOTICE

- When measuring flash-light color in high ambient light conditions (580lx-s or higher), select a shutter speed of 1/250 or 1/500 sec to reduce or eliminate the influence of the ambient light in the measurement. Using slower shutter speeds will include ambient light color in the measurement.
- Measuring data will be erased when the shutter speed setting is changed.

4-2

Setting the Indication and Items in Measurement Screen

4-2-1

Setting Target Color Temperature

Use this setting to establish a "target" color temperature for camera and light source filtration selection.

The target color temperature is displayed in the upper central part of the Measurement screen.

Operation

1. Touch the [Target] indication on the Measurement screen.

(Ex.) Measuring Screen Text Display

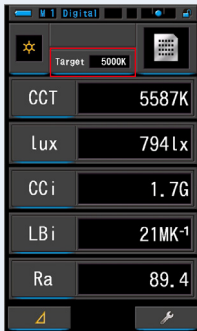

2. Enter the Target color temperature value.

The current target color temperature value and the entered value are displayed.

Target CCT Input Screen

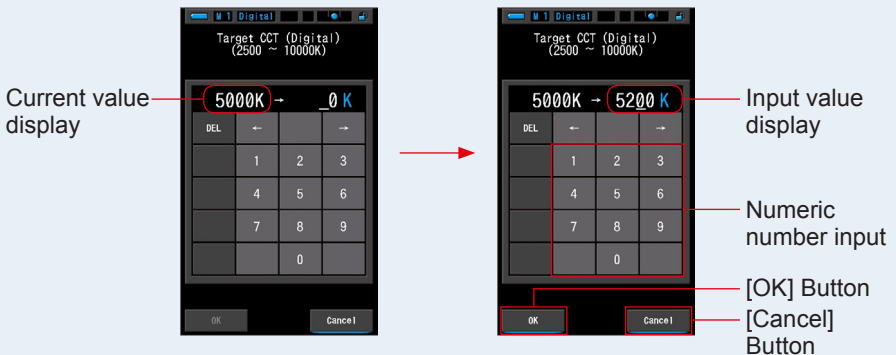

3. Touch the [OK] button.

Confirms input value and returns to previous measurement screen.

Touch [Cancel] to return to the previous measurement screen without setting Target value.

The target color temperature in Text Mode is set.



Setting Target for Digital Mode

- Set the meter to the same color temperature set on your camera. Please note that many digital cameras reproduce color better at certain color temperature settings. If your work requires optimum color reproduction and high color fidelity, select the camera manufacturers recommended color temperature for best color reproduction. (Please refer to your digital camera's operating manual.)
- You can set the color temperature from 2,500K to 10,000K in steps of 10K.
- When you frequently use multiple reference color temperatures, use preset for convenience. (➔ P94)

Setting Target for Film Mode

- Set the reference color temperature of the type of film you are using.
 - Daylight type : 5,500K
 - Tungsten Type-A : 3,400K
 - Tungsten Type-B : 3,200K
- You can set the color temperature from 2,500K to 10,000K in steps of 10K.

4-2-2 Customizing Measuring Displays

You can customize displayed information to see exactly what you need in single view.

Operation

1. Touch the [Display Item] indication on the Measurement screen.
The Display item library screen will be displayed. (⇒ P34)
2. Select the items to be displayed.
Selected items and the values will be displayed.

Measuring Screen
Text Display

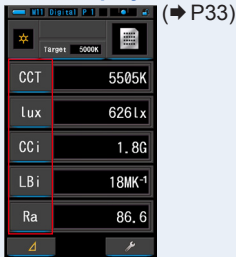

Measuring Screen
Spectrum Display

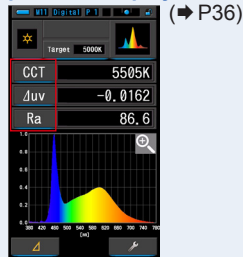

Measurement Screen
CRI Display

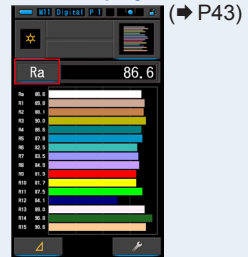

Display Item List

No.	Indication	Display Item Name	Description
1	CCT	Color Temperature Display	In Digital Mode: Displays correlated color temperature.
	PCT		In Film Mode: Displays photographic color temperature.
2	Δuv	Color Temperature Deviation	Displays deviation from the black-body radiation.
3	Lux, fc	Illuminance	Displays illuminance in lux or foot-candle.
4	Hlx, Hfc	Exposure	Displays exposure in lux-second or foot-candle-second.
5	CCI	CC Index Correction	Displays the CC correction value in CC index.
6	CCcf	CC Camera Filter Correction	Displays the CC corrected value in the compensation filter name. The filter brand is selected in the Measuring screens and Setting Mode.
	CClf	CC Lighting Filter Correction	
7	LBI	LB Index Correction	Displays the LB corrected value in LB index.
8	LBcf	LB Camera Filter Correction	Displays the LB corrected value in the compensation filter name. The filter brand is selected in the Measuring screens and Setting Mode.
	LBlf	LB Lighting Filter Correction	
9	Ra	Average CRI	Displays the average value of CRI R1 to R8.
10	R1 ~ R15	CRI Number	Displays Individual CRI number from R1 to R15.

* Models sold in some countries do not display illuminance and exposure in "fc (fc-s)" due to legal restrictions.







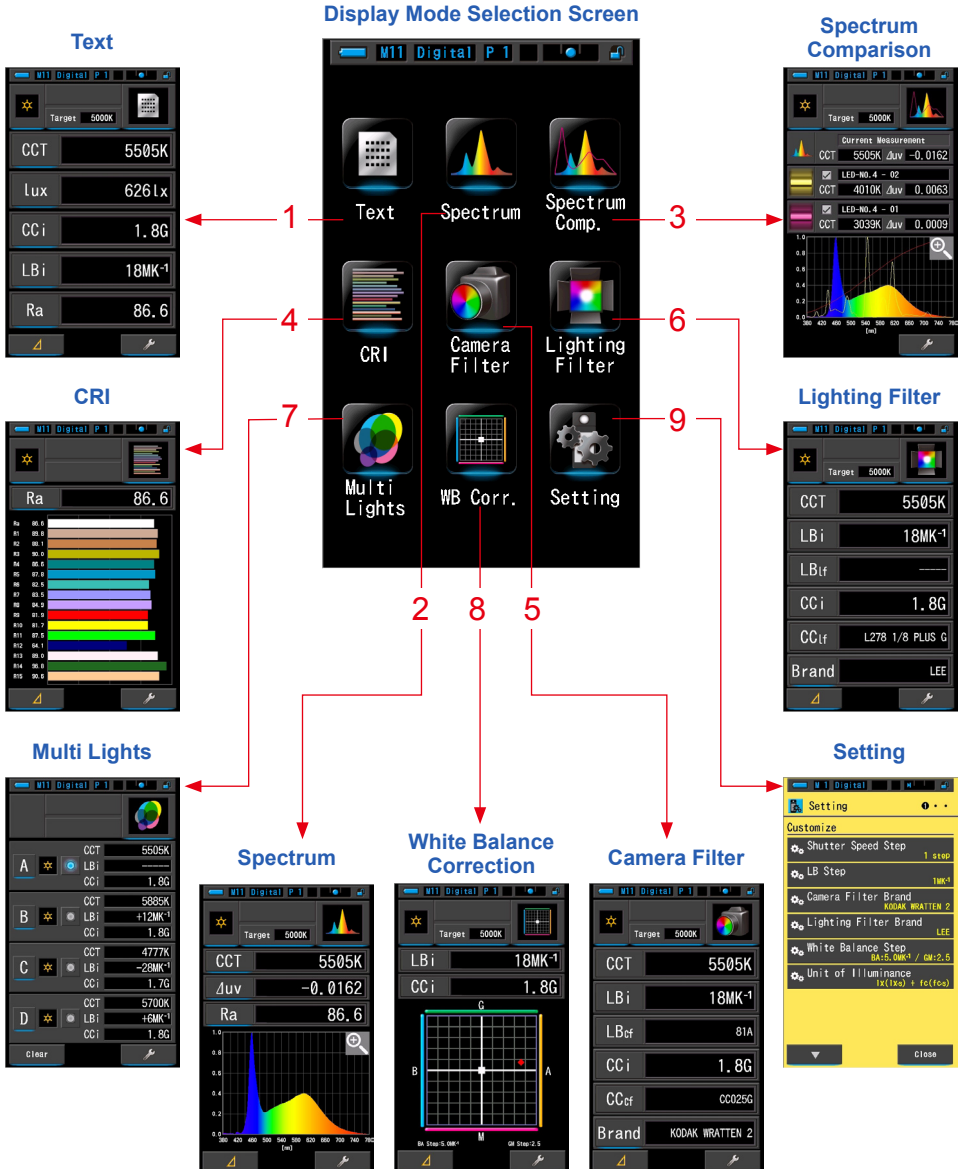

4-3 Selecting the Display Mode

Touching an icon on the Display Mode Selection screen displays lighting information in different ways to suit your needs.

* Pressing the Menu Button **6** returns the screen to the Display Mode Selection.



Display Mode Icons List

No.	Icon	Display Mode Name	Description
1		[Text] Icon	Displays user-selected 5 items in numeric values. (➔ P33)
2		[Spectrum] Icon	Displays 3 user-selected values and spectrum distribution graph. (➔ P36)
3		[Spectrum Comparison] Icon	Compares the current measurement value and up to 2 memorized values in the spectrum distribution graph. (➔ P38)
4		[CRI] Icon	Displays the selected average CRI (Ra) or individual CRI (R1 ~ R15) numerically. Each CRI is displayed in a bar graph. (➔ P43)
5		[Camera Filter] Icon	Displays correction values and camera filter names required to adjust measured source to Target Color temperature. (➔ P45)
6		[Lighting Filter] Icon	Displays correction values and light-source filter names required to adjust measured source to Target Color temperature. (➔ P48)
7		[Multi Lights] Icon	Displays comparative correction values from multiple measurements. (➔ P51)
8		[White Balance Correction] Icon	Displays the difference between the current measurement value and the target color temperature in a white balance graph. (➔ P57)
9		[Setting] Icon	Displays Setting screen. (➔ P59)

* 1 ~ 8 are the Measurement screen.

Operation

1. Touch the [Display Mode] icon on the Measurement screen or press Menu Button ⑥ on the meter.

The Display Mode Selection screen will be displayed. (→ P29)

Display modes from No.1 to 8 are for measurement.

Display mode No.9 is for settings.

2. Touch a desired Display Icon.

The measurement screen in selected Display Mode appears on the screen.

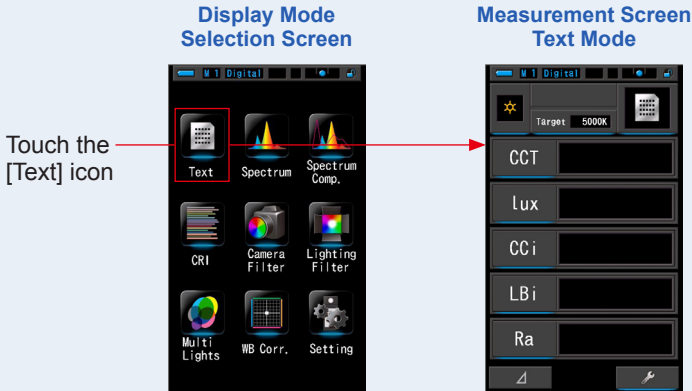

3. Press the Measuring Button ⑤ to measure. Light Selection Ring ②

The Light Selection Ring ② should be set to L (⚡ ()) when taking ambient light measurements.

When measuring flash units, select Range L (⚡ ()) or Range H (⚡ ()) depending on the brightness of the flash. (→ P88, → P90)

Measurements can now be made.

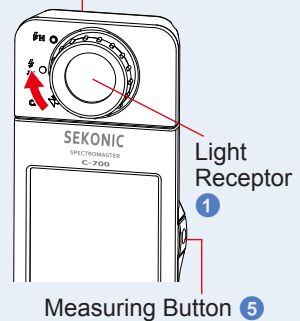

NOTE

- To measure the color temperature of a light source properly, point Light Receptor ① directly at light source during reading.
- Measurements and display will take longer in light levels below 30lx. The LCD illumination will normally switch off during measurements to avoid influence to measurements.

4. Observe measurement values on Text Mode.

Measurement Screen Text Mode

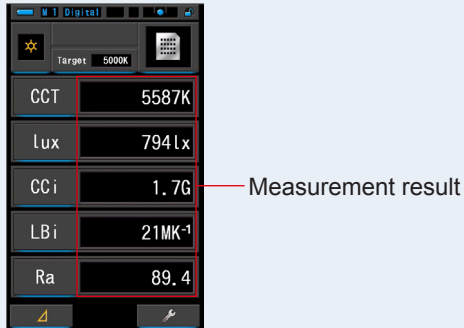

5. Memorize the measurement results.

Measurement results can be memorized.

To record measurements, press Memory Button **7**. (→ P97)

4-3-1 Displaying in Text [Text] Mode

Selected 5 items are displayed in text.

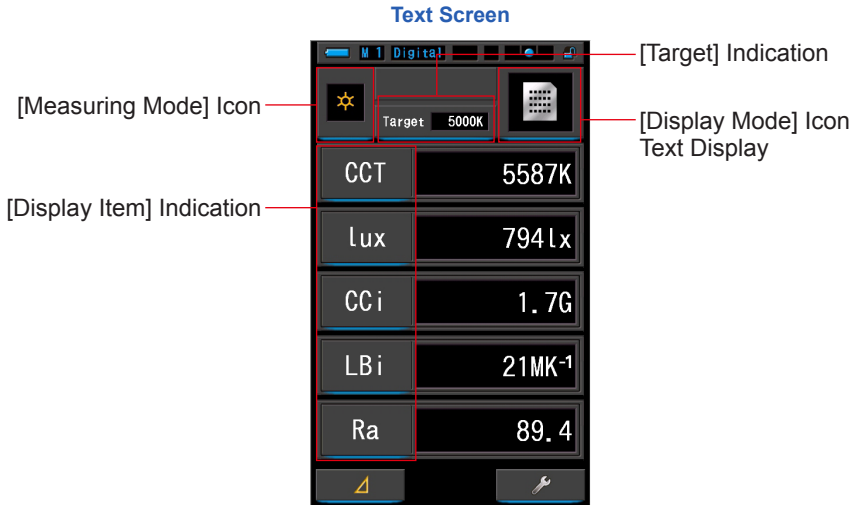

Operation

1. Touch the [Text] icon on the Display Mode screen.

A Text screen will be displayed. (⇒ P29)

2. Touch the [Measuring Mode] icon.

The Measuring Mode Selection screen will be displayed. Select the desired measuring mode to use. (⇒ P22)

3. Touch the [Target] indication.



Target CCT Input screen will be displayed. (⇒ P26)
Set the desired color temperature number.

4. Touch the [Display Item] indication to change.

The Display item library screen will be displayed.

The currently selected display item will be encircled in blue.

5. Touch the desired Display Item indication and [OK] button.

Confirms the settings, and returns to the Measurement screen.

To return to the Measurement screen without changing, touch the [Cancel] button.

Text Screen

Touch [Display Item] indication you want to change.

Display Item Library (in Ambient Light Mode) Page 1

Display Item Library (in Flash Light Mode) Page 1

Display Item Library (In Both Modes) Page 2

In Film Mode

PCT

To page 2

To page 1

Touch the desired Display Item. Indication will be encircled in blue.

[OK] Button

[Cancel] Button

New Display Item appears.

Text Screen

CCT	5587K
Lux	794Lx
CCi	1.7G
LBi	21MK ⁻¹
Ra	89.4

Display Item Library (in Ambient Light Mode) Page 1

CCT	Δuv	CCi	CCcf
CClf	LBi	LBcf	LBlf
Lux	fc		

Display Item Library (in Flash Light Mode) Page 1

CCT	Δuv	CCi	CCcf
CClf	LBi	LBcf	LBlf
Hlx	Hfc		

Display Item Library (In Both Modes) Page 2

Ra	R1	R2	R3
R4	R5	R6	R7
R8	R9	R10	R11
R12	R13	R14	R15

Display Item Library (in Ambient Light Mode) Page 1

CCT	Δuv	CCi	CCcf
CClf	LBi	LBcf	LBlf
Lux	fc		

Display Item Library (in Flash Light Mode) Page 1

CCT	Δuv	CCi	CCcf
CClf	LBi	LBcf	LBlf
Hlx	Hfc		

Display Item Library (In Both Modes) Page 2

Ra	R1	R2	R3
R4	R5	R6	R7
R8	R9	R10	R11
R12	R13	R14	R15

Display Item Library (in Ambient Light Mode) Page 1

CCT	Δuv	CCi	CCcf
CClf	LBi	LBcf	LBlf
Lux	fc		

Display Item Library (in Flash Light Mode) Page 1

CCT	Δuv	CCi	CCcf
CClf	LBi	LBcf	LBlf
Hlx	Hfc		

Display Item Library (In Both Modes) Page 2

Ra	R1	R2	R3
R4	R5	R6	R7
R8	R9	R10	R11
R12	R13	R14	R15

Display Item Library (in Ambient Light Mode) Page 1

CCT	Δuv	CCi	CCcf
CClf	LBi	LBcf	LBlf
Lux	fc		

Display Item Library (in Flash Light Mode) Page 1

CCT	Δuv	CCi	CCcf
CClf	LBi	LBcf	LBlf
Hlx	Hfc		

Display Item Library (In Both Modes) Page 2

Ra	R1	R2	R3
R4	R5	R6	R7
R8	R9	R10	R11
R12	R13	R14	R15



Text Screen

CCT	5587K
Δuv	-0.0151
CCi	1.7G
LBi	21MK ⁻¹
Ra	89.4

* Models sold in some countries do not display "fc (fc-s)" due to legal restrictions.

6. Press the Measuring Button 5 to measure.

The Light Selection Ring 2 should be set to L () when taking ambient light measurements.

When measuring flash units, select Range L () or Range H () depending on the brightness of the flash. (➔ P88, ➔ P90)

Measurements can now be made.

Light Selection Ring 2

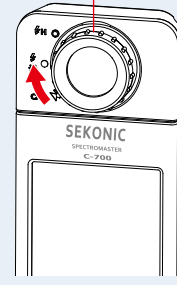

Measuring Button 5



NOTE

It may take longer time in case of taking measurement under low light (under 30lx).

It is not defect that LCD backlight becomes darker while taking measurement to avoid any influence.

7. Memorize the measurement results.

Measurement results can be memorized.

To record measurements, press Memory Button 7. (➔ P97)

4-3-2 Displaying in Spectrum Graph [Spectrum] Mode

Displays three user-selected values and spectral distribution graph.

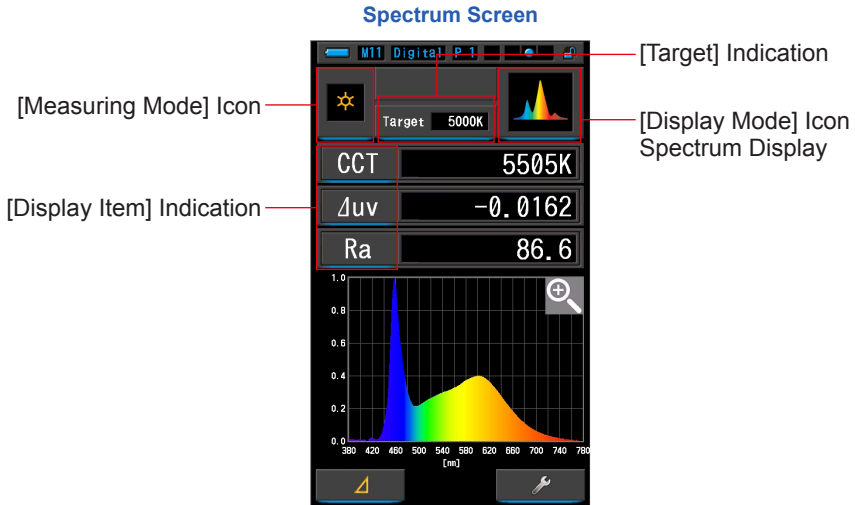

Operation

1. Touch the [Spectrum] icon on the Display Mode screen.

A spectrum distribution graph screen will be displayed. (⇒ P29)

2. Touch the [Measuring Mode] icon.

The Measuring Mode Selection screen will be displayed. Select the desired measuring mode to use. (⇒ P22)

3. Touch the [Target] indication.

Target CCT Input screen will be displayed. (⇒ P26)
Set the desired color temperature number.

4. Touch the [Display Item] indication to change.

The Display item library screen will be displayed. (⇒ P34)
Touch the desired Display Item and [OK] button.

5. Press the Measuring Button 5 to measure.

The Light Selection Ring 2 should be set to L (⚡ (☀️)) when taking ambient light measurements.

When measuring flash units, select Range L (⚡ (☀️)) or Range H (⚡⚡ (☀️)) depending on the brightness of the flash. (➡ P88, ➡ P90)

Measurements can now be made.

Light Selection Ring 2



Measuring Button 5



NOTE

Measurements and display will take longer in light levels below 30lx. The LCD illumination will normally switch off during measurements to avoid influence to measurements.

6. Touch the [Magnifying Glass (+)] icon on the screen.

The spectrum distribution graph will be enlarged.

The enlarged graph is displayed on the whole screen (landscape).

To return to the Spectrum screen, touch the [Magnifying Glass (-)] icon on the enlarged spectrum distribution graph.

Spectrum Screen

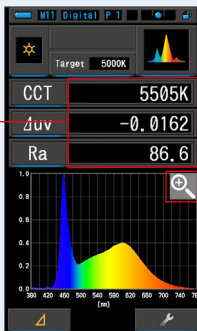

Measurement results are displayed.

Spectrum Distribution Graph Enlarged Display

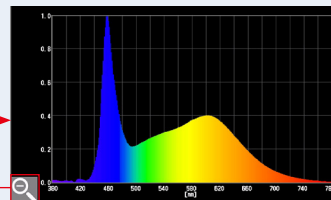

NOTICE

When the enlarged graph is displayed, measurement cannot be performed.



NOTE

The maximum display value of the Y-axis can be selected by the item [Spectrum Y-axis Scale] icon in page 2 of Setting. (➡ P140)

7. Memorize the measurement results.

Measurement results can be memorized.

To record measurements, press Memory Button 7. (➡ P97)

4-3-3

Displaying in Spectrum Comparison [Spectrum Comp.] Mode

Displays the current measured value plus up to two selected values from the meter's memory for comparison.

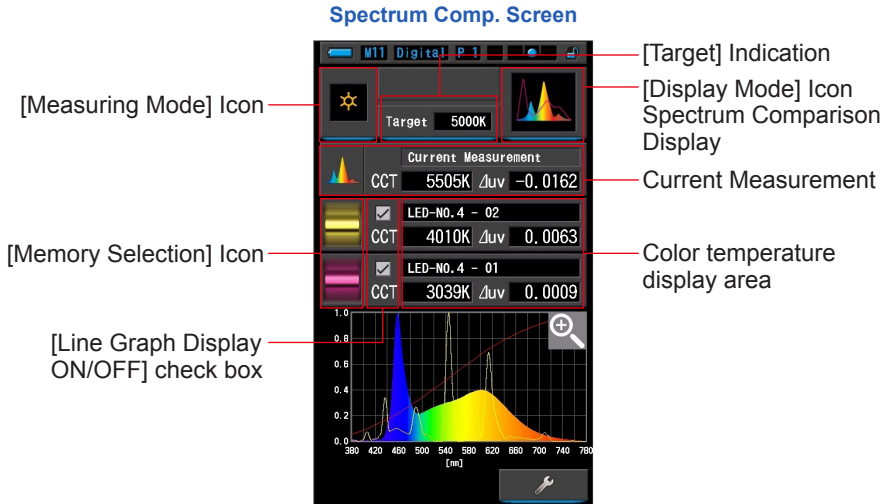



Operation

1. Touch the [Spectrum Comp.] icon on the Display Mode screen.
The Spectrum Comp. screen will be displayed. (➔ P29)
2. Touch the [Measuring Mode] icon.
The Measuring Mode Selection screen will be displayed. Select the desired measuring mode to use. (➔ P22)
3. Touch the [Target] indication.
Target CCT Input screen will be displayed. (➔ P26)
Set the desired color temperature number.

4. Press the Measuring Button 5 to measure.

The Light Selection Ring 2 should be set to L () when taking ambient light measurements.

When measuring flash units, select Range L () or Range H () depending on the brightness of the flash. (→ P88, → P90)

Measurements can now be made.

Light Selection Ring 2



Measuring Button 5



NOTE

Measurements and display will take longer in light levels below 30lx. The LCD illumination will normally switch off during measurements to avoid influence to measurements.

5. The current measurement is displayed at the top of display area.

6. Touch the [Memory Select] icon.

The [Spectrum Comp. Memory] screen will be displayed.

Spectrum Comp. Screen

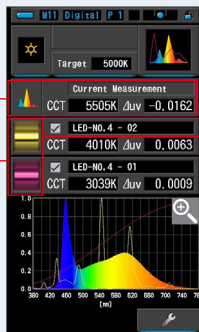

Current Measurement

[Memory Selection] Icon

Spectrum Comp. Memory Screen

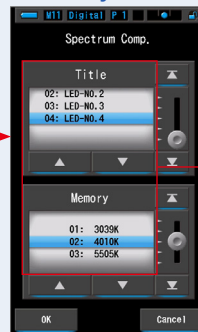

Memory Selection Area

If no measurements have been memorized, a message will be displayed to indicate this pop-up screen.

Memory Selection Pop-up Screen

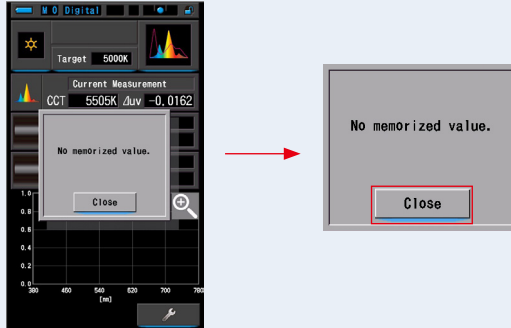

After you confirmed the message "No memorized value.", touch the [Close] button. Returns to the Spectrum Comp. screen.

7. Select the desired memory data to compare the spectrum.

When a title is selected, the memory linked to the title will be displayed. Select a memorized reading for display and comparison.

To select a title and a memory, match them with the blue background positions.

Spectrum Comparison Title/Memory Screen

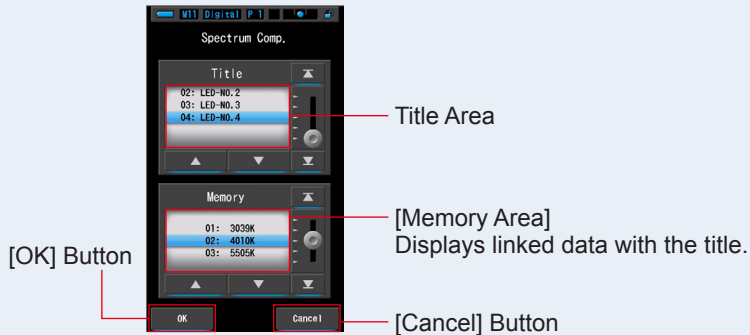

8. Touch the [OK] button.

Confirms the setting and returns to the Spectrum Comp. screen.

To cancel the setting, touch the [Cancel] button.

9. The titles and measurements of the selected memories will be displayed on the Spectrum Comp. screen.

Memory Title Display



10. Line graphs will be displayed in the spectrum graph.

Touch the [Line Graph Display ON/OFF] to hide/show a line graph on the screen.

* shows line. hides line.

Spectrum Comp. Screen

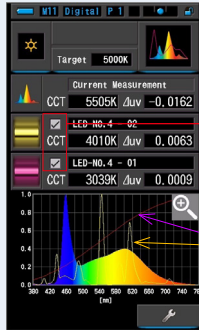

[Line Graph Display ON/OFF]
Check Box

Line Graph

11. Touch the [Magnifying Glass (+)] icon.

The spectrum comparison graph will be enlarged.

The enlarged graph is displayed on the whole screen (landscape).

To return to the Spectrum Comp. screen, touch the [Magnifying Glass (-)] icon on the enlarged spectrum comparison graph.

Spectrum Comp. Screen

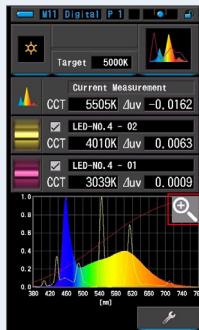

Spectrum Comparison Graph Enlarged Display

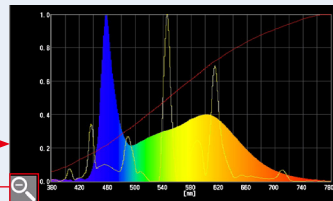

When the enlarged graph is displayed, measurement cannot be performed.

**NOTE**

- The maximum display value of the Y-axis can be selected by the item [Spectrum Y-axis Scale] icon in page 2 of Setting. (→ P140)
- During Spectrum Comparison, the Contrast Function is not available and [] button will be hidden.

12. Memorize the measurement results.

Measurement results can be memorized.

To record measurements, press Memory Button . (→ P97)

4-3-4 Displaying in Color Rendering Index [CRI] Mode

Displays the selected average CRI (Ra) or individual CRI (R1 ~ R15) numerically. Each CRI is also displayed in a bar graph.

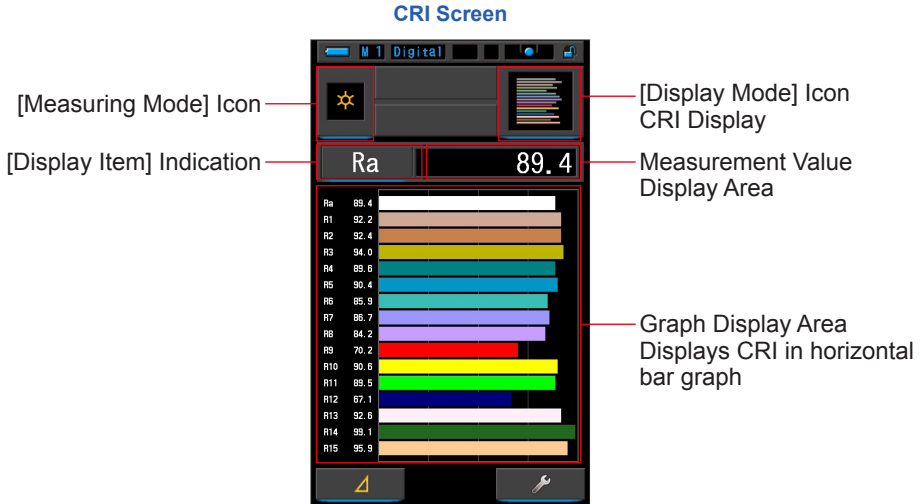

Operation

1. Touch the [CRI] icon on the Display Mode screen.

The CRI screen will be displayed. (→ P29)

2. Touch the [Measuring Mode] icon.

The Measuring Mode Selection screen will be displayed. Select the desired measuring mode to use. (→ P22)

3. Press the Measuring Button ⑤ to measure.

The Light Selection Ring ② should be set to L () when taking ambient light measurements.

When measuring flash units, select Range L () or Range H () depending on the brightness of the flash. (→ P88, → P90)

Measurements can now be made.

Light Selection Ring ②

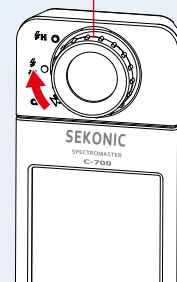

Measuring Button ⑤



- Graph display areas Ra, R1 ~ R15 are always displayed.
- Measurements and display will take longer in light levels below 30lx. The LCD illumination will normally switch off during measurements to avoid influence to measurements.
- Ra is the averaged value from R1 to R8 only. R9 to R15 are not included in the Ra.

4. Touch the [Display Item] indication to change.

The Display item library screen will be displayed.

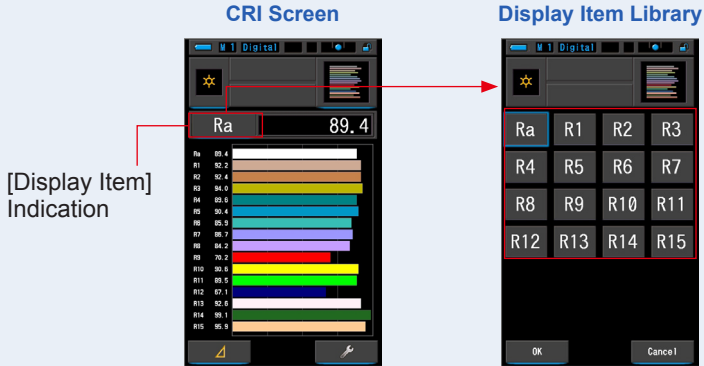

5. Touch the desired Display Item.

Select the item to display above the graph.
Indication will be encircled in blue.

6. Touch the [OK] button.

Returns to the CRI screen by the [OK] button.

Touching the [Cancel] button returns to the CRI screen without the display item being changed.

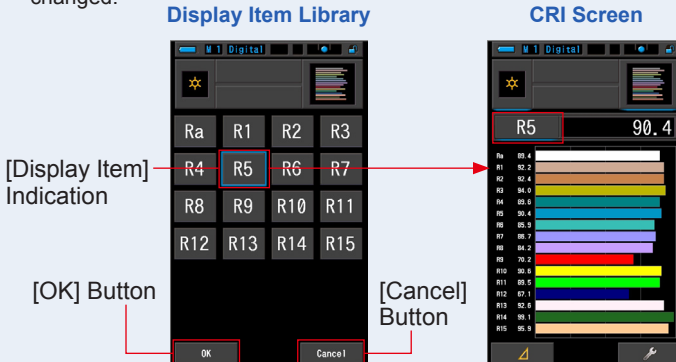

4-3-5 Displaying in Camera Filter [Camera Filter] Mode

Displays correction values and camera filter names required to adjust measured source to Target Color temperature.

You can select filter brand on this screen or in Setting screen. (Kodak WRATTEN 2, FUJIFILM or LEE).

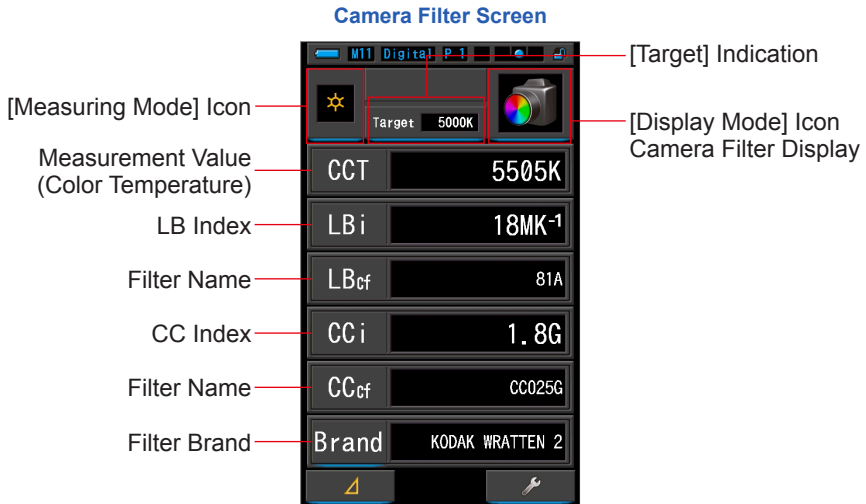

Operation

1. Touch the [Camera Filter] icon on the Display Mode screen.

The Camera Filter screen will be displayed. (⇒ P29)

2. Touch the [Measuring Mode] icon.

The Measuring Mode Selection screen will be displayed. Select the desired measuring mode to use. (⇒ P22)

3. Touch the [Target] indication.

Target CCT Input screen will be displayed. (⇒ P26)
Set the desired color temperature number.

4. Touch the Filter [Brand] indication to open the Camera Filter Brand selection screen. Then touch the indication for filter brand you are using and [OK] button to return to the measuring screen.

Filtration is available in KODAK WRATTEN 2, FUJIFILM or LEE.

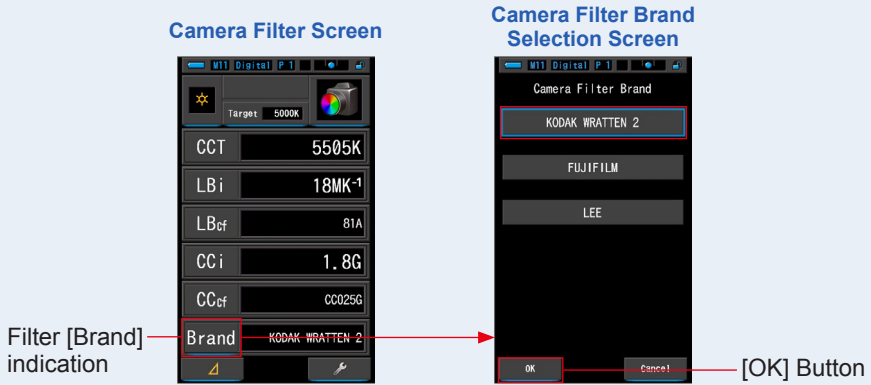

5. Press the Measuring Button 5 to measure.

The Light Selection Ring 2 should be set to L (⚡) when taking ambient light measurements.

When measuring flash units, select Range L (⚡) or Range H (⚡) depending on the brightness of the flash. (⇒ P88, ⇒ P90)

Measurements can now be made.

Light Selection Ring 2

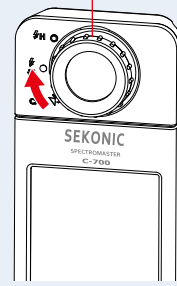

Measuring Button 5



Measurements and display will take longer in light levels below 30lx. The LCD illumination will normally switch off during measurements to avoid influence to measurements.

6. Memorize the measurement results.

Measurement results can be memorized.

To record measurements, press Memory Button **7**. (➔ P97)



NOTE

The filter manufacturer can also be selected by the item [Camera Filter Brand] in page 1 of Setting. (➔ P132)

4-3-6 Displaying in Lighting Filter [Lighting Filter] Mode

Displays correction values and light-source filter names required to adjust measured source to Target Color temperature.

You can select filter brand on this screen or in Setting screen (LEE, ROSCO E-COLOUR+ or CINEGEL).

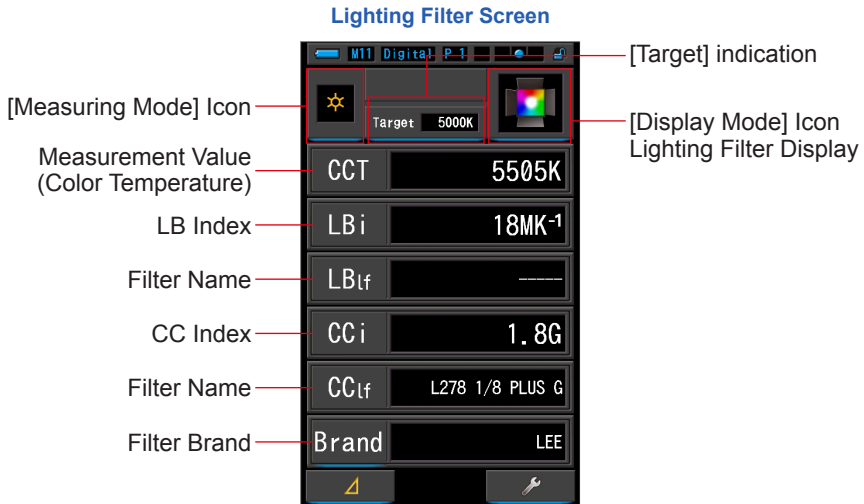

Operation

1. Touch the [Lighting Filter] icon on the Display Mode screen.

The Lighting Filter screen will be displayed. (⇒ P29)

2. Touch the [Measuring Mode] icon.

The Measuring Mode Selection screen will be displayed. Select the desired measuring mode to use. (⇒ P22)

3. Touch the [Target] indication.

Target CCT Input screen will be displayed. (⇒ P26)
Set the desired color temperature number.

4. Touch the Filter [Brand] indication to open the Lighting Filter Brand selection screen. Then touch the indication for filter brand you are using and [OK] button to return to the Measuring Screen.

Filtration is available in LEE, ROSCO CINEGEL or ROSCO E-COLOUR+.

The meter will display the brand filter number and generic filter value for both LB (CTO, CTB) and CC (Plus / Minus Green).

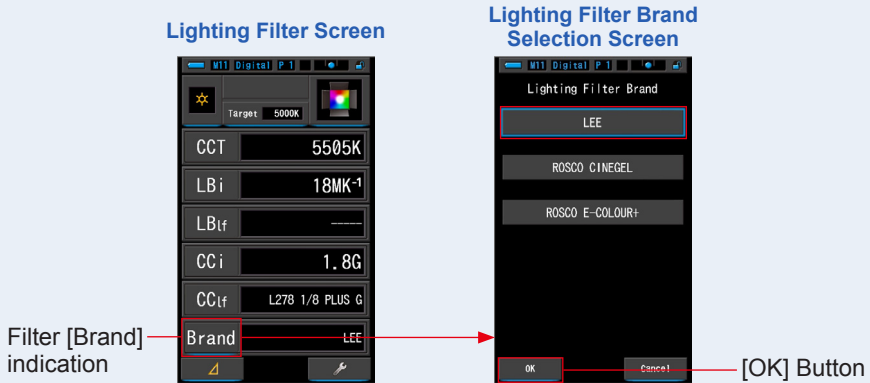

5. Press the Measuring Button 5 to measure.

The Light Selection Ring 2 should be set to L (⚡ (🔵)) when taking ambient light measurements.

When measuring flash units, select Range L (⚡ (🔵)) or Range H (⚡ (🔴)) depending on the brightness of the flash. (➔ P88, ➔ P90)

Measurements can now be made.

Light Selection Ring 2

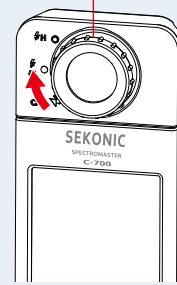

Measuring Button 5



Measurements and display will take longer in light levels below 30lx. The LCD illumination will normally switch off during measurements to avoid influence to measurements.

6. Memorize the measurement results.

Measurement results can be memorized.

To record measurements, press Memory Button **7**. (➔ P97)



NOTE

The filter manufacturer can also be selected by the item [Lighting Filter Brand] on the page 1 of Setting. (➔ P134)

4-3-7 Displaying to Compare Light Sources [Multi Lights] Mode

Displays comparative correction values from multiple measurements.

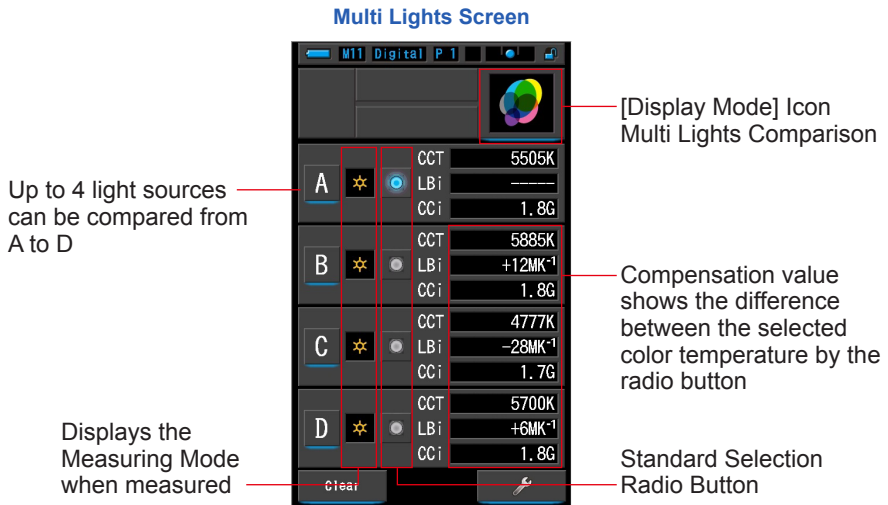

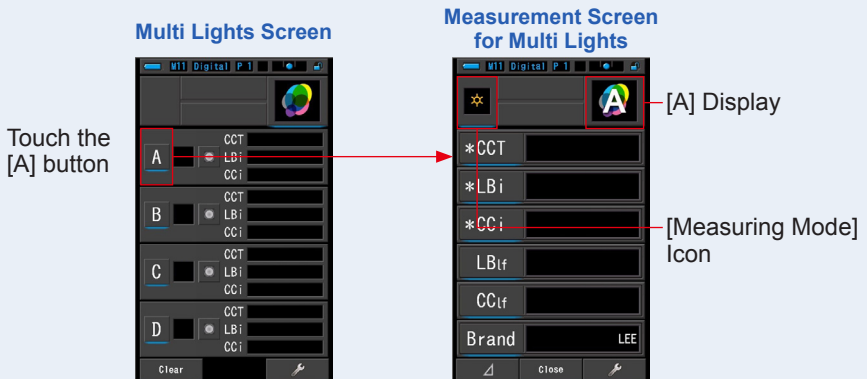

Operation

1. Touch the [Multi Lights] icon on the Display Mode screen.
The Multi Lights screen will be displayed. (→ P29)
2. Touch the [A] button.
The Measuring screen of [A] will be displayed.



3. Press the Measuring Button 5 to measure.

The Light Selection Ring 2 should be set to L () when taking ambient light measurements.

When measuring flash units, select Range L () or Range H () depending on the brightness of the flash. (→ P88, → P90)

The measurement results will be displayed.

Light Selection Ring 2

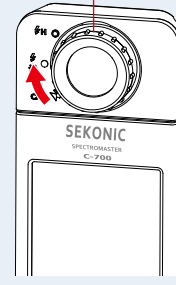

Measuring Button 5

Measurement Results Screen for Multi Lights

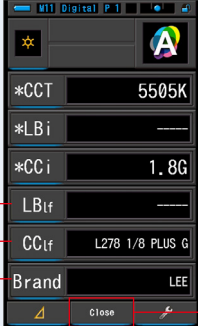

Filter Name — LBtf

Filter Name — CCtf L278 1/8 PLUS G

Filter Brand — Brand LEE

[Close] Button

NOTE

- Measurements and display will take longer in light levels below 30lx. The LCD illumination will normally switch off during measurements to avoid influence to measurements.
- When Memory button is pressed while in this Measurement Result Screen in Multi Lights, the value can be stored in memory.

4. Touch the [Display Item] indication to change.

The Display item library screen will be displayed.

The currently selected display item will be encircled in blue.

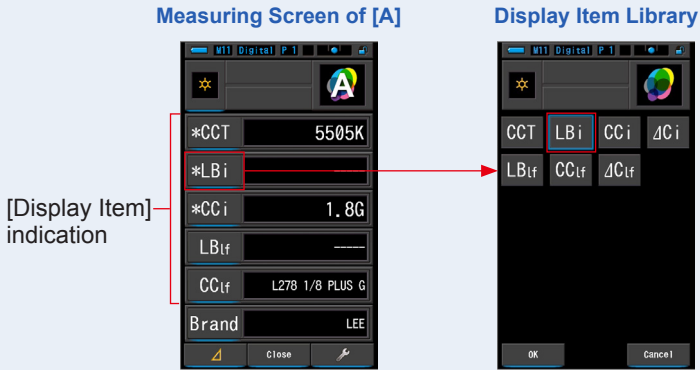

5. Touch the desired Display Item indication and [OK] button.

Confirms the settings, and returns to the Measurement screen. The first three selections marked by * will be displayed on the Multi Lights screen for this and subsequent measurements.

To return to the Measurement screen without changing, touch the [Cancel] button.

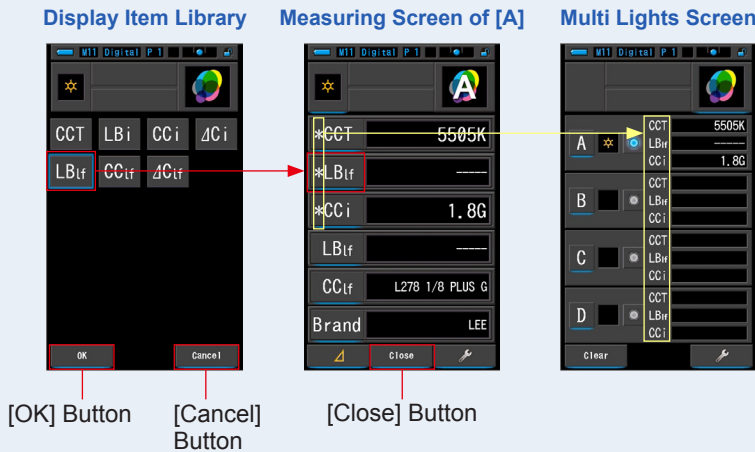

**NOTE**

- CC_i** CC index number is to compensate the difference from the black body radiation.
- ΔCC_i** Delta CC index number is the difference between standard light source and other light sources instead of difference from the black body radiation.
- CC_{lf}** CC Lighting Filter number is to compensate the difference from the black body radiation
- ΔCC_{lf}** Delta CC Lighting Filter number is to match to the CC value of light source selected as standard. This is useful when the light source selected as standard cannot be filtered to correct (such as fluorescent lamp on the ceiling), and need to match all other light sources to the standard light source in CC filter.

6. Touch the [Close] button.

The message "Set the measured value. Are you sure?" will be displayed.

Message Confirmation Screen

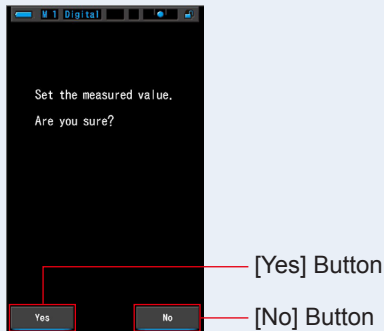

7. Touch the [Yes] button.

Returns to the Multi Lights screen. (Measurement results are reflected in the light source [A])

To return to the Multi Lights screen without reflecting the results, touch the [No] button.

Multi Lights Screen

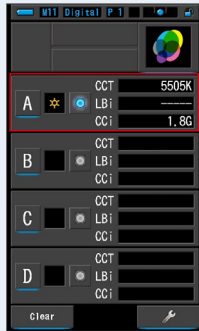

Measurement results are displayed.

8. Measure other light sources for comparison.

Repeat steps 1 through 7 for display areas B, C and D. Up to 4 light sources can be compared.



NOTE

- Touch the A, B, C or D button to confirm the measured values.
- Measurements and display will take longer in light levels below 30lx. The LCD illumination will normally switch off during measurements to avoid influence to measurements.
- When Memory button is pressed while in this Measurement Result Screen in Multi Lights, the value can be stored in memory.

9. Touch the radio button of the light source to set as the standard.

(●: Selected, ○: Not selected)

Correction value of each other light sources (not selected as standard) are displayed in any value you selected on the Display Item screen.

If LB/CC index or LB/CC Light Filter is selected, the reference value area will display "-----".

Also if any selected indication values in other light sources displays "-----", it means there is little value to correct.

Multi Lights Screen

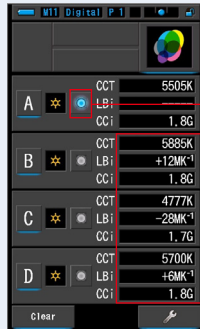

Standard Selection Radio Button Selected Status

Corrected Value Display



NOTE

To clear all of the measurement results and start a measurement comparison again, touch the [Clear] button.

The Multi Lights Clear Confirmation screen will be displayed.

Multi Lights Screen

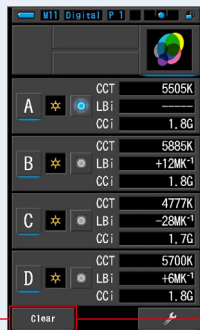

[Clear] Button

Clear Confirmation Screen

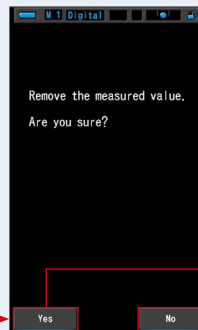

[Yes] Button

[No] Button

Touch the [Yes] button.

All (A ~ D) will be deleted, and it will return to the Multi Lights screen.

When the [No] button is touched, the display returns to the Multi Lights screen without deleting the values.

4-3-8

Displaying in White Balance Correction Graph [WB Corr.] Mode

Displays the difference between the current measurement value and the target color temperature in a white balance correction graph.

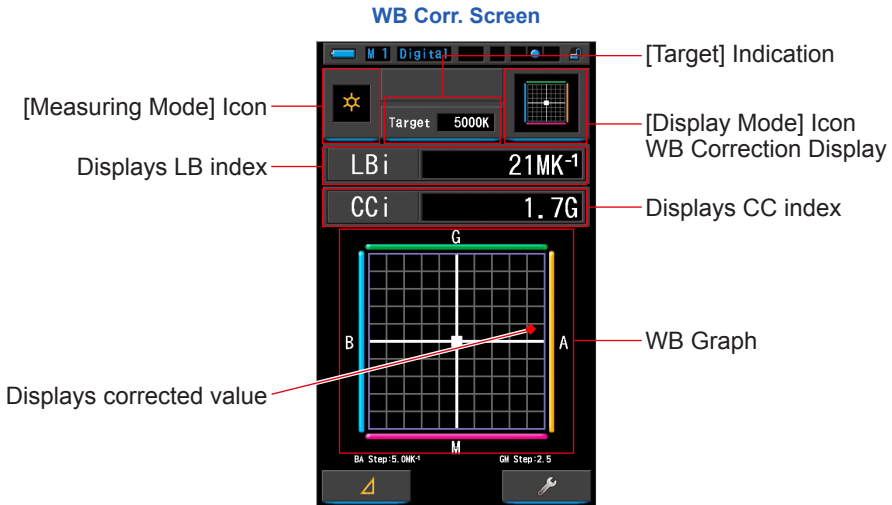



Operation

1. Touch the [WB Corr.] icon on the Display Mode screen.
The WB Corr. screen will be displayed. (⇒ P29)
2. Touch the [Measuring Mode] icon.
The Measuring Mode Selection screen will be displayed. Select the desired measuring mode to use. (⇒ P22)
3. Touch the [Target] indication.
Target CCT Input screen will be displayed. (⇒ P26)
Set the desired color temperature number.

4. Press the Measuring Button 5 to measure.

The Light Selection Ring 2 should be set to L () when taking ambient light measurements.

When measuring flash units, select Range L () or Range H () depending on the brightness of the flash. (➔ P88, ➔ P90)

Measurements can now be made.

Light Selection Ring 2



Measuring Button 5



NOTE

Measurements and display will take longer in light levels below 30lx. The LCD illumination will normally switch off during measurements to avoid influence to measurements.

5. The red point shows the correction value from the target color temperature.

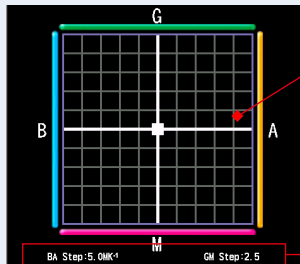

Displays corrected value

Displays value per one matrix

6. Memorize the measurement results.

Measurement results can be memorized.

To record measurements, press Memory Button 7. (➔ P97)



NOTE

The value per matrix can be changed by the item [White Balance Step] in page 1 of Setting. Match the value with your camera. (➔ P136)

4-3-9 Displaying Setting [Setting] Screen

Displays the settings. The contents can be changed according to usage.

For more information about how to set and the details of specifications, see "7-1-1 Item List". (➔ P124)

Setting Screen
Page 1

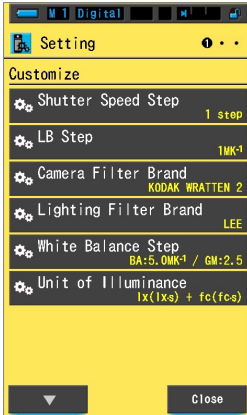

Setting Screen
Page 2

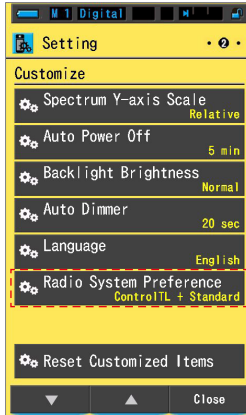

Setting Screen
Page 3



* Models sold in some countries do not display illuminance and exposure in "fc (fc·s)" due to legal restrictions. In this case, Unit of Illuminance is not displayed.

* Indicated only for C-700R model

NOTICE

Pressing the Menu Button ⑥ will terminate the settings and return to the Display Mode Selection screen.

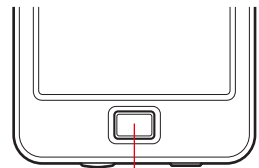

Menu Button ⑥

Operation

1. Touch the [Setting] icon on the Display Mode Selection screen.
The Setting screen will be displayed.

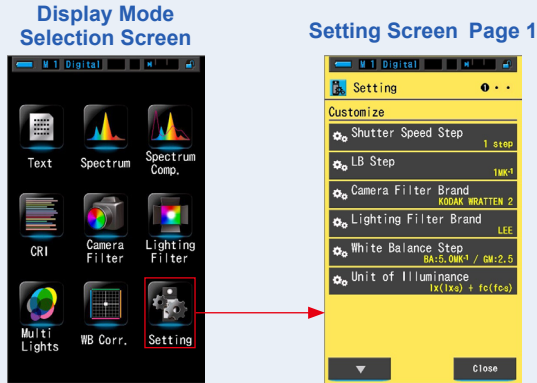

2. Setting shows items in white letters and setting contents in yellow letters.
Touch each item to change the setting.

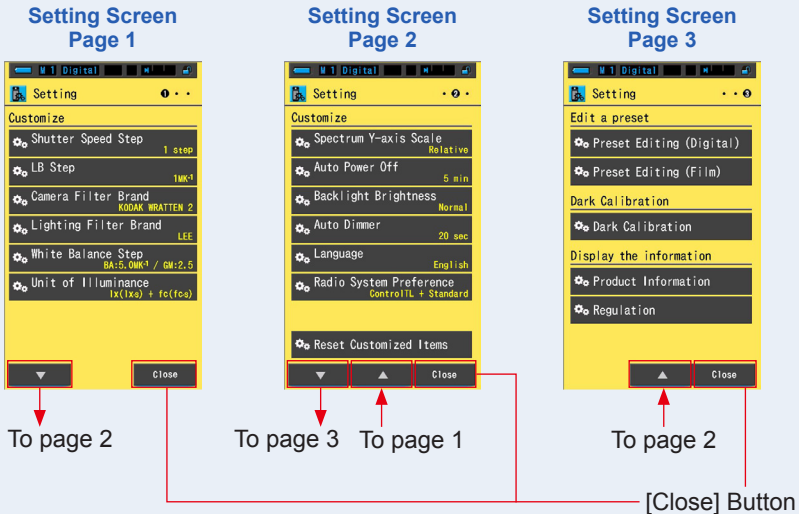

When the [Close] button is touched, the display returns to the Display Mode Selection screen. For more information about how to set and the details of specifications, see "7-1-1 Item List". (➔ P124)

5. Measuring Light Sources [Measurement Screen]

5-1 Measurement Method

5-1-1 Balancing Color Temperatures of Light Sources

When multiple light sources are being used, the color temperature of each light source must be measured separately. If light sources with different color temperatures are used together in the same image, inconsistent color will be present in the shadows and highlights. Take a measurement by facing the Light Receptor ① towards the light source to correctly measure the color temperature of the light source.

Light Receptor ①

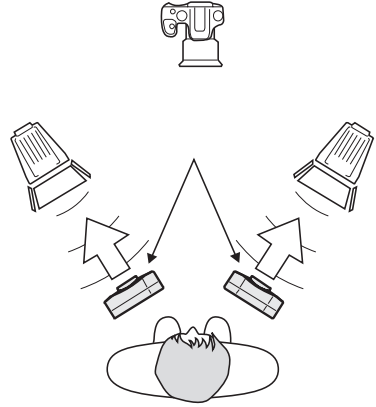

NOTICE

- It is always important to get the true color of the main light source. Then any influence from light reflected off of colored surfaces onto the subject will look as they do when observed by eye.
- When measuring the light source, be careful not to measure the light reflected off from ceiling, wall or floor because precision of measurements may be affected.
- Because it may affect the precision of the measurements, be careful not to damage or dirty the white surface of the Light Receptor ①. If the Light Receptor ① becomes dirty, wipe it with a dry and soft cloth. Never use organic solvents such as thinner or benzene.
- There may be those who are sensitive to flash or other strong lights (photosensitivity), and they may be negatively affected by light. Therefore, be careful when people are nearby during measurement.

5-2

Measurement in Ambient Light Mode

Select Ambient Light Mode when taking measurements of natural light (sunlight), and continuous light sources such as LED, tungsten lamps and fluorescent lights.



NOTICE

Do not look directly into sunlight or other strong light when measuring. It may cause severe eye damage or even loss of vision.

Operation

1. Touch the [Tool Box] icon.

Touch and select the [Digital/Film] button. (→ P92)

[Tool Box] icon
on the Measurement Screen



Tool Box Screen

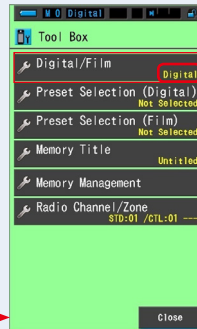

The set content is displayed in yellow letter at the lower right hand corner of the button.

2. Select the type of camera (Digital or Film) used.

Touch either the [Digital] or [Film] button.

Digital/Film Screen

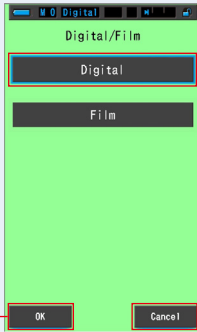

The selected icon will be displayed encircled in blue.

[OK] Button

[Cancel] Button

3. Touch the [OK] button.

Confirm and return to the Measurement screen.

To return to the Measurement screen without confirming, touch the [Cancel] button.

4. On the Measurement screen, touch the [Measuring Mode] icon and select the [Ambient Light Mode] icon on the next screen.

Select the measuring mode. (→ P22)

Measurement Screen



Measuring Mode Selection Screen

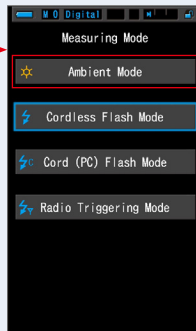

Measurement Screen



5. Touch the [Target] indication.

Target CCT screen will be displayed. (→ P26)
Set the color temperature.

Measurement Screen

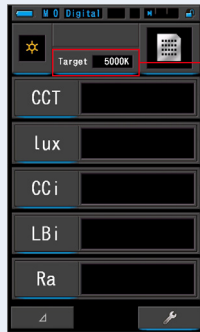

Target CCT Screen

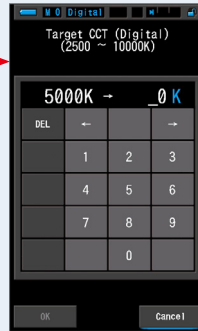

NOTE

If you are not using LB index/filter and CC index/filter values, you can omit this step.

You cannot set the target color temperature using the "CRI" or "Multi Lights Mode".



NOTE

If necessary, you can select a previously created Preset value from Preset Selection in the Tool Box. (→ P154)

Tool Box Screen

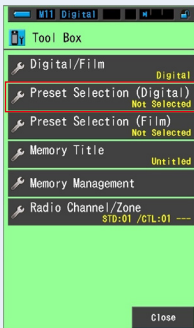

Preset Selection Screen

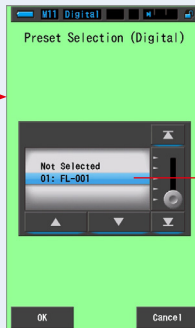

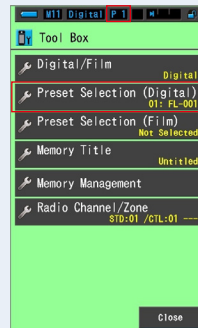

Tool Box Screen



The selected value is indicated by the blue background.

If no presets have been created, the Preset Selection will be grayed out and touching the button will not display the Preset Selection Display.
You can omit this step if unnecessary.

6. Confirm the light measuring range.

When you return to the Measurement screen, make sure to select Range L ( ).

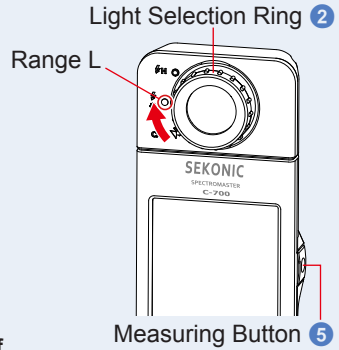

7. Press the Measuring Button 5.

Measurement will be taken and the light source values will be displayed.

While the button is held, the meter measures continuously.

When the button is released, the measurements will stop and the light source value at the time of release will be displayed.

NOTE

- [Over] or [Under] will be displayed if the light source illumination is too bright or not bright enough, or if the color temperature is out of the measurement range, when the Measuring Button is pressed. In this case, adjust the brightness or color temperature of light source.
- Measurements and display will take longer in light levels below 30lx. The LCD illumination will normally switch off during measurements to avoid influence to measurements.

Measurement in Ambient Light Mode is complete.

5-3

Measurement in Cordless Flash Mode

Cordless Flash Mode is preferable when the flash to subject distance is too far to use a sync cord or when wireless measuring is desired. In this measuring mode, the meter will go into measurement standby mode (for 90 seconds) to wait for a burst of flash to measure.

Operation

1. Touch the [Tool Box] icon.

Touch and select the [Digital/Film] button. (→ P92)

[Tool Box] Icon
on the Measurement Screen



Tool Box Screen

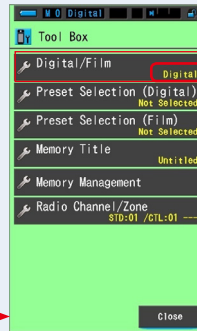

The set
content is
displayed.

2. Select the type of camera (Digital or Film) used.

Touch either the [Digital] or [Film] button.

Digital/Film Screen



The selected icon will be displayed
encircled in blue.

[OK] Button

[Cancel] Button

3. Touch the [OK] button.

Confirm and return to the Measurement screen.

To return to the Measurement screen without confirming, touch the [Cancel] button.

4. On the Measurement screen, touch the [Measuring Mode] icon and select the [Cordless Flash Mode] icon on the next screen.

Select the measuring mode. (→ P22)

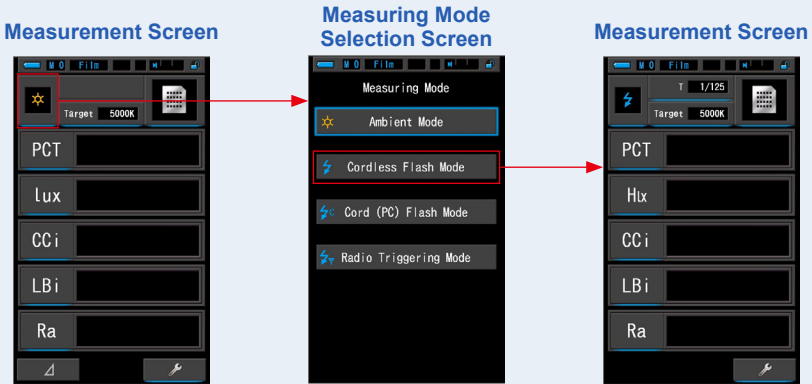

5. Touch the [Target] indication.

Target CCT screen will be displayed. (→ P26)

Set the color temperature.

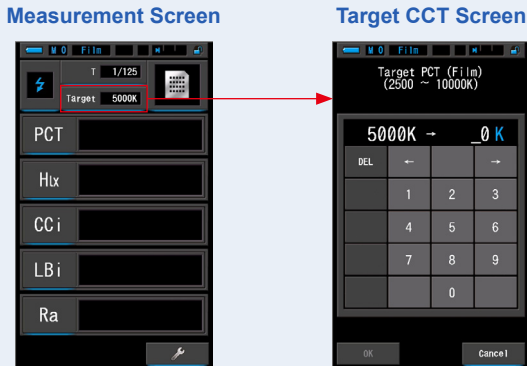

If you are not using LB index/filter and CC index/filter values, you can omit this step.

You cannot set the target color temperature using the "CRI" or "Multi Lights Mode".

6. Touch the [T (Shutter Speed)] indication on the Measurement screen.

Set the shutter speed used for measurements. (→ P24)

Match the blue background with the desired shutter speed.

Measurement Screen



Shutter Speed Display Screen

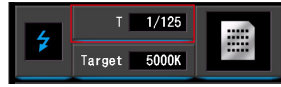

Shutter Speed Screen

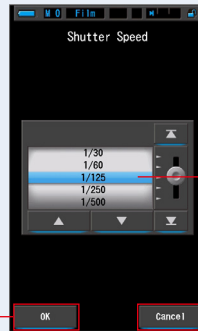

The selected value is indicated by the blue background.

[OK] Button



[Cancel] Button



NOTICE Select a shutter speed range that will synchronize with your camera and flash system.



7. Confirm the light measuring range.

When you return to the Measurement screen,

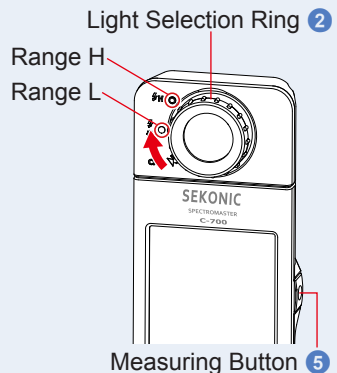
select Range L  or Range H  depending on the brightness of the flash.



**NOTE**

- Range L : Select when measuring small and low power flash units (lower than 640lx·s), [Over] will appear if flash power is too high. Select Range H.
- Range H : Select when measuring powerful flash units (brighter than 580lx·s) [Under] will appear if flash power is too low. Select Range L.

8. Press the Measuring Button .

The meter will enter measurement standby mode.

While the icon is blinking, manually trigger the flash.

The [Measuring Mode] icon will blink for 90 seconds when measuring.

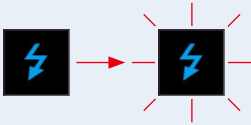

The display illumination will dim when the measuring button is pressed as the display illumination can affect the reading. This is normal.

When the flash light is fired, the measured value will be displayed for 3 seconds, and the display will return to measurement standby mode.

To cancel standby mode, touch the screen or press the Menu Button .

**NOTE**

When the icon stops blinking before triggering the flash, or when you want to take measurements again, press Measuring Button  again.

Measurement in Cordless Flash Mode is complete.



CAUTION

- Do not trigger flash while skin or other objects are in contact with the flash tube. Do not touch the flash tube after repeated flashes. (It may cause burns.)
- Do not trigger flash while near the eyes of people or animals. (It may temporarily affect vision.)
- The flash may be triggered suddenly. Because there is the possibility of burns or negative effects on vision, please handle with care.



NOTICE

- If the flash output power is too weak compared to the surrounding light, the meter may not detect the flash output. In this case, use "5-4 Measurement in Cord (PC) Flash Mode". (➔ P71)
- Pulsed light sources such as fluorescent lights or special lighting could cause the meter to take cordless flash measurements in rare cases. In these situations, use "5-4 Measurement in Cord (PC) Flash Mode". (➔ P71)
- If the Light Receptor ① detects a sudden and bright change in lighting intensity, the meter may mistakenly take a measurement. To avoid this, take "5-4 Measurement in Cord (PC) Flash Mode". (➔ P71)
- Because the light radiated from a flash bulb gradually builds, the meter will not detect the light when used in Cordless Flash Mode.
Be sure to take "5-4 Measurement in Cord (PC) Flash Mode". (➔ P71)
- When using Cordless Flash Mode, the LCD screen backlight dims during measurement, and the LCD backlight is illuminated for only 3 seconds after measurement. To cancel standby mode, touch the screen or press the Menu Button ⑥.



NOTE

- When using the meter in Cordless Flash Mode, it is possible to mount the meter to a light stand, tripod or similar support using the Tripod Socket ⑩.
- [Over] or [Under] will be displayed if the light source illumination is too bright or not bright enough, or if the color temperature is out of the measurement range, when the Measuring Button is pressed. In this case, adjust the brightness or color temperature of light source, or switch the light range. (➔ P90)

5-4

Measurement in Cord (PC) Flash Mode

Cord (PC) Flash Mode is preferable when lighting conditions prevent the use of cordless measurements or when certain types of equipment require a physical sync connection.

In Cord (PC) Flash Mode, the meter and flash unit are connected with a Sync Cord (sold separately).



CAUTION

- Do not handle this product with wet hands, or leave it in the rain or in a location where it may be splashed with water, submerged, or come into contact with moisture. There is a danger of electric shock in Cord (PC) Flash Mode. This may also result in damage to the product.
- When using flash with high voltage, there is a danger of electric shock if you touch the Sync Terminal ⑫. Handle the flash with care when using for measurement.

Operation

1. Touch the [Tool Box] icon.

Touch and select the [Digital/Film] button. (⇒ P92)

[Tool Box] Icon
on the Measurement Screen



Tool Box Screen

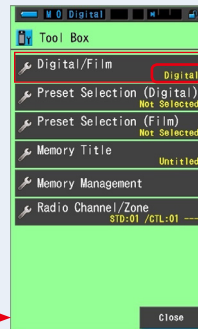

The set
content is
displayed.

2. Select the type of camera (Digital or Film) used.

Touch either the [Digital] or [Film] button.

Digital/Film Screen

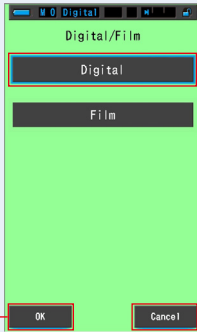

The selected icon will be displayed encircled in blue.

[OK] Button

[Cancel] Button

3. Touch the [OK] button.

Confirm and return to the Measurement screen.

To return to the Measurement screen without confirming, touch the [Cancel] button.

4. On the Measurement screen, touch the [Measuring Mode] icon and select the [Cord (PC) Flash Mode] icon on the next screen. Select the measuring mode. (→ P22)

Measurement Screen



Measuring Mode Selection Screen

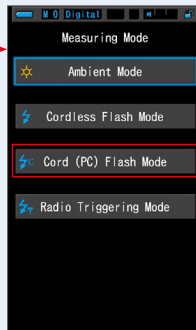

Measurement Screen



5. Touch the [Target] indication.

Target CCT screen will be displayed. (→ P26)
Set the color temperature.

Measurement Screen

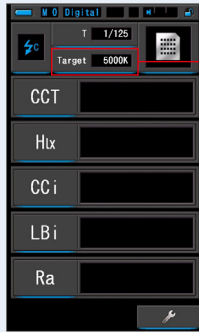

Target CCT Screen



NOTE

If you are not using LB index/filter and CC index/filter values, you can omit this step.

You cannot set the target color temperature using the "CRI" or "Multi Lights Mode".

6. Connect the sync cord (sold separately) to the Sync Terminal 12 of the meter.

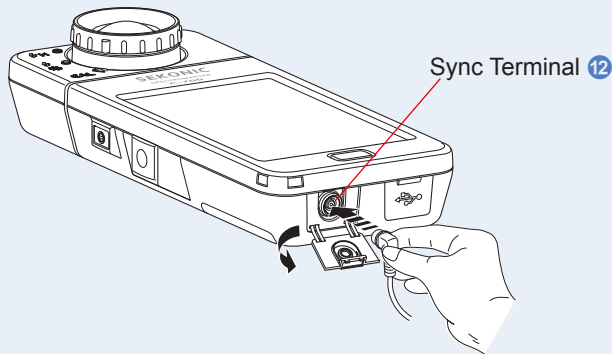

7. Touch the [T (Shutter Speed)] indication on the Measurement screen.

Set the shutter speed used for measurements. (→ P24)

Match the blue background with the desired shutter speed.

Measurement Screen



Shutter Speed Display Screen

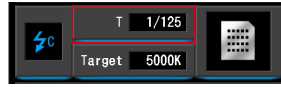

Shutter Speed Screen

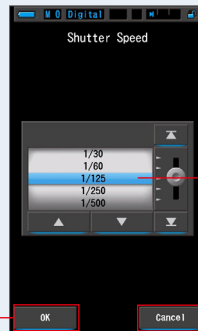

The selected value is indicated by the blue background.

[OK] Button

[Cancel] Button



CAUTION

- Depending on the flash equipment used, the flash may be triggered when the sync cord is connected to the Sync Terminal ⑫ or when operating the Power Button ③. Because there is the possibility of burns or negative effects on vision, please handle with care.

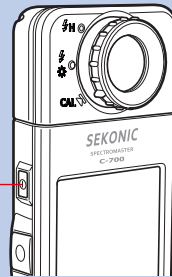



Power Button ③

NOTICE

- Select a shutter speed that will synchronize with your camera and flash system.
- If the triggering voltage of the flash used is extremely low, the flash may not trigger. In this case, use "5-3 Measurement in Cordless Flash Mode". (→ P66)



8. Confirm the light measuring range.

When you return to the Measurement screen,

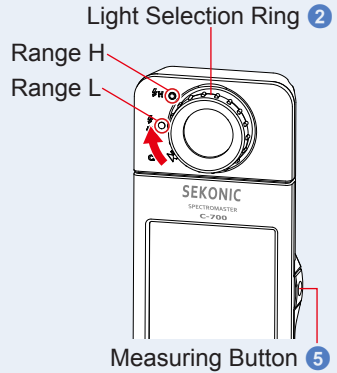
select Range L  or Range H  depending on the brightness of the flash.



NOTE

- Range L : Select this when measuring small and low power flash units (lower than 640lx·s), [Over] will appear if flash power is too high. Select Range H.
- Range H : Select when measuring powerful flash units (brighter than 580lx·s) [Under] will appear if flash power is too low. Select Range L.

9. Press the Measuring Button ⑤.

Measurement will be taken with flash, and the light source values will be displayed.

Because it affects measurement while measuring, the LCD backlight will dim. It is not a defect.

Measurement in Cord (PC) Flash Mode is complete.



CAUTION

- Depending on the flash equipment used, the flash may be triggered when the sync cord is connected to the Sync Terminal ⑫ or when operating the Power Button ③. Because there is the possibility of burns or negative effects on vision, please handle with care.
- Do not trigger flash while skin or other objects are in contact with the flash tube. Do not touch the flash tube after continuous flashes. (It may cause burns.)
- Do not trigger flash while near the eyes of people or animals. (It may temporarily affect vision.)
- The flash may be triggered suddenly. Because there is the possibility of burns or negative effects on vision, please handle with care.



NOTICE

- If the triggering voltage of the flash used is extremely low, the flash may not trigger. In this case, use "5-3 Measurement in Cordless Flash Mode". (➔ P66)
- When measuring flash bulbs, make sure the shutter sync speed is set to the proper synchronization range of your camera.



NOTE

[Over] or [Under] will be displayed if the light source illumination is too bright or not bright enough, or if the color temperature is out of the measurement range, when the Measuring Button is pressed.

In this case, adjust the brightness or color temperature of light source, or switch the light range. (➔ P90)

5-5

Measurement in Radio Triggering Flash Mode (C-700R Only)

The Radio Triggering Flash Mode is a measurement method that triggers flash from the meter wirelessly by connecting to the flash through a radio receiver (sold separately). This allows a single person to cordlessly perform flash measurement. Before taking a measurement, you must set the transmitter (meter) and the receiver to the same radio channel.

* Compatibility with C-700R

The PocketWizard® Series from LPA and other flash devices equipped with PocketWizard® systems are compatible. Read the instruction manual of the radio receiver for information about how to operate it.

For information about compatible devices, refer to LPA's website (www.pocketwizard.com).

**WARNING**

- **Do not use near industrial, scientific or medical devices such as pacemakers. The radio waves may affect the operation of pacemakers.**



CAUTION

- Do not use within hospitals and other medical institutions, or near medical electrical equipment.
The radio waves may cause accidents through misoperation.
- Do not use the meter inside airplanes.
The radio waves may cause accidents through misoperation.
- Stop using the meter when there is electromagnetic interference with other devices.
The radio waves may cause accidents through misoperation.
- To comply with local broadcast regulations, Sekonic wireless systems sold in the various markets around the world are designed to operate at different frequencies.
 - * Sekonic meters having a FCC&IC designation on the back of body are designed for operation in the USA and Canadian market.
[Frequencies]
 - Standard System: CH1 to 16 - 344.0MHz
CH17 to 32 - 346.5 to 354.0MHz
 - Control System: CH1 to 4 - 340.0 to 346.0MHz
CH5 to 20 - 341.5 to 351.0MHz
 - * Sekonic meters having a CE designation on the back of body are designed for operation in European countries.
[Frequencies]
 - Standard System: CH1 to 16 - 433.62MHz
CH17 to 32 - 434.22 to 354.0MHz
 - Control System: CH1 to 3 - 433.42 to 434.42MHz
- Both FCC and CE versions of C-700R have built-in transmitting antennas that are specifically tuned for their market area. When purchasing and/or using the meter with a receiver, be sure that the meter and receiver are designed to be used in your location and use the same frequency.

 **NOTICE**

The working distance of the wireless triggering system differs depending on the position and direction of the radio receiver. For the best conditions, follow these steps when placing the meter and the radio receiver.

1. Make sure nothing is between the meter and the radio receiver.
2. Place the radio receiver away from any large metallic objects, concrete, and objects with large amounts of water (people, plants, etc.).
3. Secure the radio receiver with tape or a tripod. When placing on the flash pack, make sure the antenna of the radio receiver is higher than the flash pack. Prevent the radio receiver antenna from directly contacting metallic material.
4. Depending on the shooting location, there may be times when the radio receiver receives no signal. This may be due to radio reflection from nearby objects or other causes. Under normal conditions, moving the radio receiver a few centimeters may improve reception.
Do not place the radio receiver behind things that absorb or easily intercept radio waves, such as concrete, metal, or hills.
5. Use within approximately 30m (100 feet) while following the above conditions.

5-5-1 Measurement Method

Selecting Radio Channels

ControlTL[®] channels and Standard channels are the radio channels of the meter that can be used for measurements.

ControlTL[®] Channels:

The C-700R is designed for use with PocketWizard[®] radios. There are 20 channels for FCC&IC, and 3 for CE. You can set 3 zones (A, B and C) for each channel. When used with ControlTL radios, the C-700R cannot control flash power, and can only trigger flash.

Standard Channels:

The C-700R is designed for use with PocketWizard[®] radios. There are 32 meter channels. Channels No.1 ~ 16 are single channels. Channels No.17 ~ 32 can have 4 zones (A, B, C, D).

5-5-2 Setting the Radio Channel

The radio channel can be set from the Tool Box or from the channel indication in the lower light corner of the Measurement screen.

For how to set the channel from the Tool Box, refer to the Tool Box item. (➔ P115)

Operation

1. Touch the [Tool Box] icon.

Touch and select the [Digital/Film] button. (➔ P92)

[Tool Box] Icon
on the Measurement Screen



Tool Box Screen

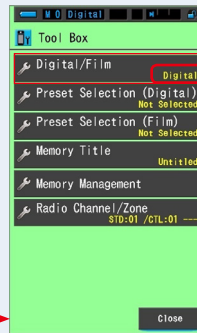

The set content is displayed.

2. Select the type of camera (Digital or Film) used.

Touch either the [Digital] or [Film] button.

Digital/Film Screen



The selected icon will be displayed encircled in blue.

[OK] Button

[Cancel] Button

3. Touch the [OK] button.

Confirm and return to the Measurement screen.

To return to the Measurement screen without confirming, touch the [Cancel] button.

4. On the Measurement screen, touch the [Measuring Mode] icon and select the [Radio Triggering Flash Mode] icon on the next screen.

Select the measuring mode. (⇒ P22)

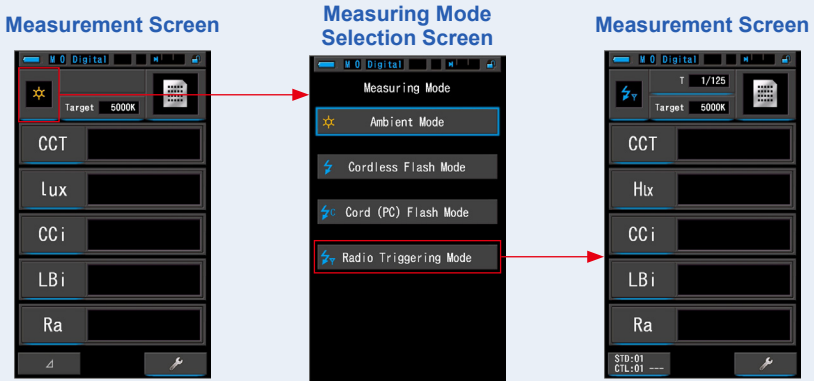

5. Touch the [Target] indication.

Target CCT will be displayed. (⇒ P26)

Set the color temperature.

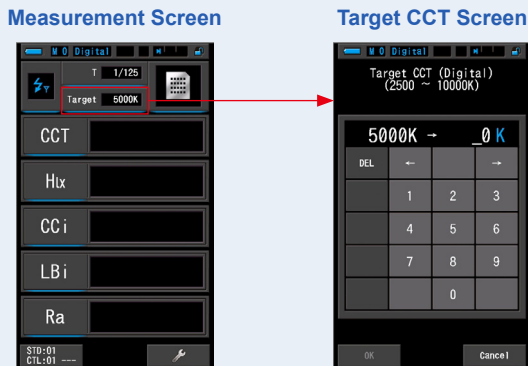

 **NOTE**

If you are not using LB index/filter and CC index/filter values, you can omit this step.
You cannot set the target color temperature using the "CRI" or "Multi Lights Mode".

6. Touch the [T (Shutter Speed)] indication on the Measurement screen.

Set the shutter speed used for measurements. (→ P24)

Match the blue background with the desired shutter speed.

Measurement Screen



Shutter Speed Display Screen

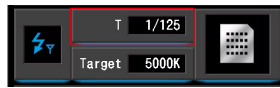

Shutter Speed Screen

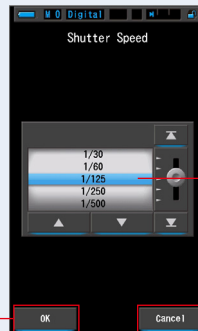

The selected value is indicated by the blue background.

[OK] Button

[Cancel] Button

 **NOTICE**

Select a shutter speed that will synchronize with your camera and flash system.

7. Touch the [Radio Channel/Zone] button.

Set the radio channel/zone to use. (→ P115)

When you touch the [CTL] tab or the [STD] tab, the screen will change.

Measurement Screen



Radio Channel/Zone (ControlTL® Channel) Screen

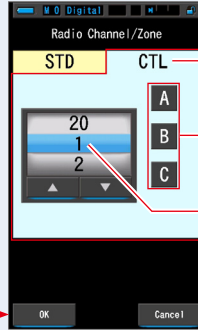

[CTL] Tab

[Zone] Button

Channel Number
(1 ~ 20)

Radio Channel/Zone (Standard Channel) Screen

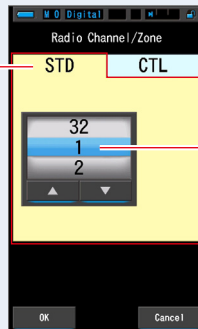

[STD] Tab

Channel Number
(1 ~ 16)

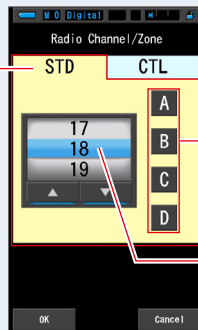

[STD] Tab

[Zone] Button

Channel Number
(17 ~ 32)



8. Confirm the light measuring range.

When you return to the Measurement screen,

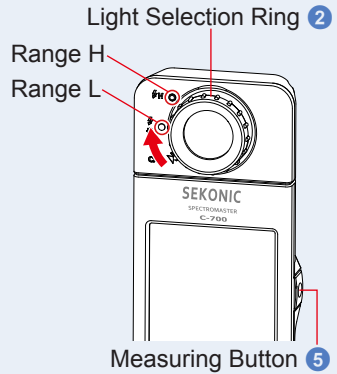
select Range L  or Range H  depending on the brightness of the flash.



NOTE

- Range L : Select when measuring small and low power flash units (lower than 640lx·s), [Over] will appear if flash power is too high. Select Range H.
- Range H : Select when measuring powerful flash units (brighter than 580lx·s) [Under] will appear if flash power is too low. Select Range L.

9. Press the Measuring Button .

Measurement will be taken with flash, and the light source values will be displayed.

The display illumination will dim when the measuring button is pressed as the display illumination can affect the reading. This is normal.

Measurement in Radio Triggering Flash Mode is complete.



CAUTION

- Do not trigger flash while skin or other objects are in contact with the flash tube. Do not touch the flash tube after continuous flashes. (It may cause burns.)
- Do not trigger flash while near the eyes of people or animals. (It may temporarily affect vision.)
- The flash may be triggered suddenly. Because there is the possibility of burns or negative effects on vision, please handle with care.





NOTICE

- If the flash output power is too weak compared to the surrounding light, the meter may not detect the flash output. In this case, use "5-4 Measurement in Cord (PC) Flash Mode". (➔ P71)
- Pulsed light sources such as fluorescent lights or special lighting could cause the meter to take cordless flash measurements in rare cases. In these situations, use "5-4 Measurement in Cord (PC) Flash Mode". (➔ P71)
- If the Light Receptor ① detects a sudden, bright change in lighting intensity, the meter may mistakenly take a measurement. To avoid this, take "5-4 Measurement in Cord (PC) Flash Mode". (➔ P71)
- Because the light radiated from a flash bulb gradually builds, the meter will not detect the light when used in Radio Triggering Flash Mode. Be sure to take "5-4 Measurement in Cord (PC) Flash Mode". (➔ P71)
- When using Flash Cordless Mode, the LCD screen backlight dims during measurement, and the LCD backlight is illuminated for only 3 seconds after measurement. To cancel standby mode, touch the screen or press the Memory Button ⑦.

5-6

Contrast Function (in Ambient Light Mode only)

In all item (except LB, CC filter name) modes, when you touch the [Delta] icon (), the [Delta] icon changes to ().

While this mode, the difference between standard value and currently being measured value is displayed as long as the Measuring Button **5** is pressed.

The reference value is the measurement value when the [Delta] icon is pressed.

When the Measuring Button **5** is released, the standard value is displayed as the last measurement.

The graphs in Spectrum, CRI and White Balance Correction modes show the standard value only even if Contrast Function is activated.

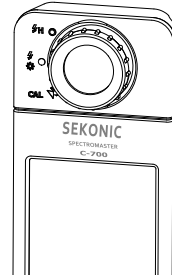

Measuring Button **5**

Operation

1. Press the Measuring Button **5** and start measurements.

The measurement results will be displayed.

Measurement Screen

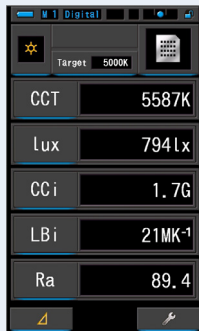

NOTE

Measurements and display will take longer in light levels below 30lx. The LCD illumination will normally switch off during measurements to avoid influence to measurements.

2. Touch the [Delta] () icon.

The measurement results right before touching the icon will become the standard values.

The [Delta] icon will change ().

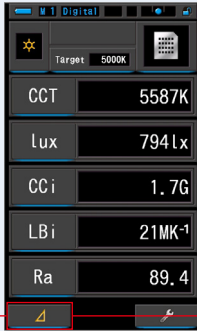

Measurement Screen

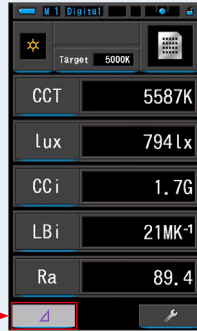

Measurement Screen



3. Press the Measuring Button .

While the [Delta] icon is change (), the difference with the standard value is displayed as long as the Measuring Button  is pressed.

Measurement Screen



4. Monitoring Function is complete.



When the Measuring Button  is released, the standard value is displayed.

5. Touch the [Delta] () icon.

The [Delta] icon will be deactivated ().



NOTE

- If the [Delta] icon () is touched before a first measurement is taken, Monitoring Function cannot be activated.
- The [Delta] icon () is deactivated when the power is turned OFF.
- When the [Delta] icon is displayed, the Memory Button  is disabled.

5-7

When [Over], [Under] or [Filter N/A] is Displayed

When [Over] or [Under] is displayed, measurement cannot be taken.
When [Filter N/A] is displayed, the indicated value is out of display while measurement can be taken.



5-7-1

Display of [Over], [Under] or [Filter N/A]

When [Over] is displayed:

If the indicated values are higher than the maximum measuring range, [Over] is displayed.



When measuring ambient light, decrease the brightness of the illumination.

When measuring flash light, turn the Light Selection Ring ②, and change the range from L ⚡ () to H ⚡H (), or lower the flash output power. ⚙️

When [Under] is displayed:

If the indicated values are lower than the minimum measuring range, [Under] is displayed.

When measuring ambient light, increase the brightness of the illumination.

When measuring flash light, turn the Light Selection Ring ②, and change the range from H ⚡H () to L ⚡ (), or raise the flash output power. ⚙️

When [Filter N/A] is displayed:

If [Filter N/A] appears in the filter number indication, it is out of display range (combination) of filter number.

Take a new measurement after changing the target color temperature.

Light Selection Ring ②

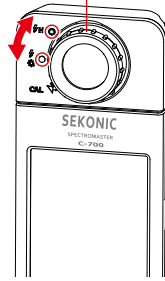

Measuring Button ⑤

**NOTE**

Measurements and display will take longer in light levels below 30lx. The LCD illumination will normally switch off during measurements to avoid influence to measurements.

**Display range:**

Color Temperature (Digital/Film) : Digital (C-700/C-700R) 1,600K ~ 40,000K
 : Film (C-700/C-700R) 1,600K ~ 40,000K

LB Index : -500 to +500MK⁻¹

LB Filter Numbers**Camera Filter**

Kodak WRATTEN 2/LEE : 80A+80B to 85B+85

FUJIFILM LBA/LBB : LBB-20 + LBB-16 to LBA-20 + LBA-16

Lighting Filter

LEE : L287 DOUBLE CTO + L204 FULL CTO to L200
 DOUBLE CTB + L283 1.5 CTB

ROSCO CINEGEL : R3420 DOUBLE CTO + R3407 FULL CTO to R3220
 DOUBLE CTB + R3202 FULL CTB

ROSCO E-COLOUR+ : E287 DOUBLE CTO + E204 FULL CTO to E200
 DOUBLE CTB + E283 1.5 CTB

CC Index : 80G to 80M

CC Filter Numbers : 200G to 200M

Camera Filter

Kodak WRATTEN 2/LEE : CC50M + CC40M to CC50G + CC40G

FUJIFILM CC : CC-50M + CC-40M to CC-50G + CC-40G

Lighting Filter

LEE : L247 MINUS GREEN + L248 1/2 MINUS GREEN to
 L244 PLUS GREEN + L245 1/2 PLUS GREEN

ROSCO CINEGEL : R3308 MINUS GREEN + R3309 3/4 MINUS GREEN to
 R3304 PLUS GREEN + R3315 1/2 PLUS GREEN

ROSCO E-COLOUR+ : E247 MINUS GREEN + E248 1/2 MINUS GREEN to
 E244 PLUS GREEN + E245 1/2 PLUS GREEN

Illuminance lux : 1lx ~ 200,000lx





Exposure lux-second : 20lx·s ~ 20,500lx·s

Illuminance foot-candle : 0.1FC ~ 18,600FC

Exposure foot-candle-second : 1.86fc·s ~ 1,902fc·s

5-7-2 Changing the Light Range

Change and use the light range depending on the brightness of the flash.

Light Selection Ring (Status Bar Display)			Content
Dark Calibration Position		CAL	Select for dark calibration only. Measurement cannot be made in this position.
Range L			Select for ALL ambient light measurement, and low power flash units (lower than 640lx·s)
Range H			Select for powerful flash units (brighter than 580lx·s) only.

Turn the Light Selection Ring ② and select the desired range.
The set range will be displayed on the LCD screen's status bar.

RANGE L Status Bar



RANGE H

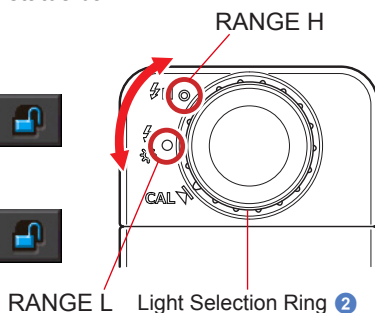

6. Measurement Tool [Tool Box] Screen

Selecting Screens from the Tool Box

Touch the [Tool Box ()] icon in the Measurement screen to display the Tool Box screen. (→ P17) You can select screens from the Tool Box as follows.

Memory Management (→ P101)

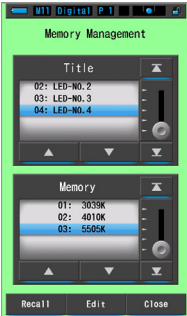

Tool Box

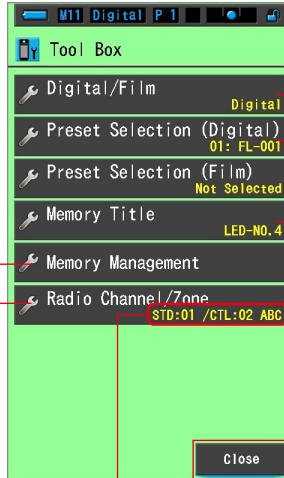

Digital/Film (→ P92)

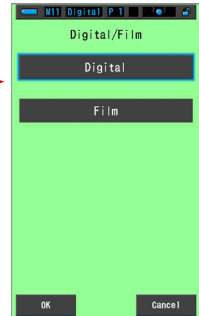

Radio Channel/Zone (→ P115)

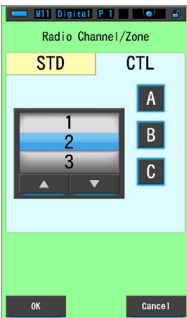

(Control[®] Channels only for C-700R model)

Preset Selection (When Using Digital) (→ P94)



Memory Title (→ P98)



The set content is displayed in yellow letter at the lower right hand corner of the button.

Return to the [Measurement Screen] by touching the [Close] button.

6-1 Selecting Digital/Film

Select "Digital" or "Film" in accordance with the type of camera.

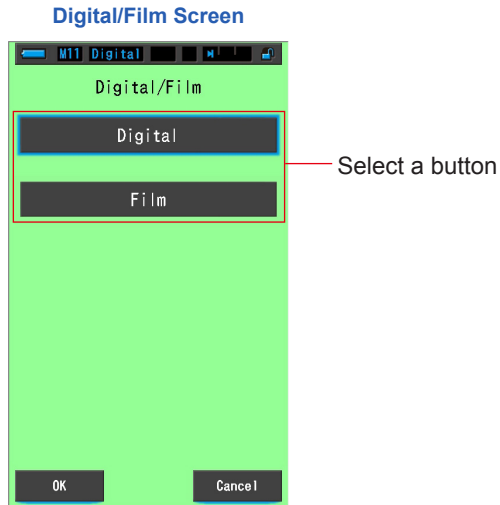

Operation

1. Touch the [Digital/Film] button.
[Digital] and [Film] button will be displayed.

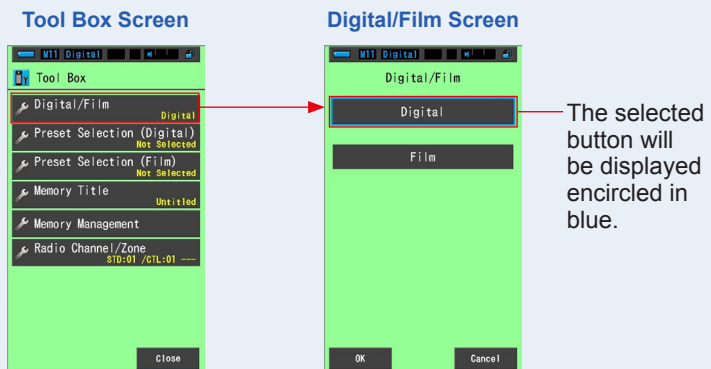

2. Touch either the [Digital] or [Film] button.

The selected button will be encircled in blue.

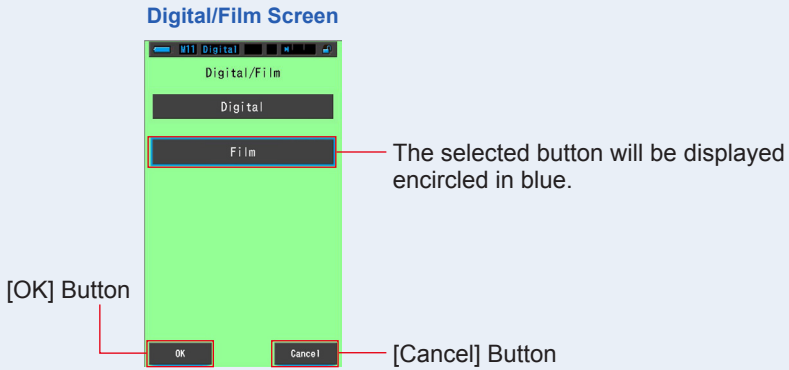

3. Touch the [OK] button.

Confirm and return to the Measurement screen.

To return to the Measurement screen without confirming, touch the [Cancel] button.

The selected status will be displayed on the status bar.



The camera type is set.

NOTICE

- If "Digital" is selected, settings based on human eye characteristics (correlated color temperature) are displayed.
If "Film" is selected, settings based on film's characteristics (photographic color temperature) are displayed.
- Please note that color reproduction may be inaccurate if "Digital" is selected when using a film camera, or vice versa.

6-2 Setting Preset Contents [Preset Selection] Screen

Presets are a quick way to introduce adjustments to the C-700's camera/light source filter recommendations.

You can create and store Presets for different lighting conditions or color effects to use when ever needed. (➔ P154)

Also, when you use several target color temperatures, setting them in "Edit a Preset" beforehand makes it easier to change target color temperatures by recalling one of presents in Tool Box even if you do not input a target color temperature every time.

Preset Selection Screen

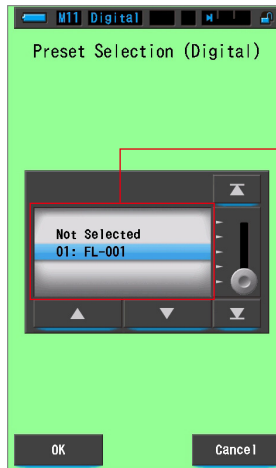

There are 19 Presets that can be displayed and used.

Operation

1. Touch the [Preset Selection] button in the Tool Box.

The Preset Selection screen will be displayed.

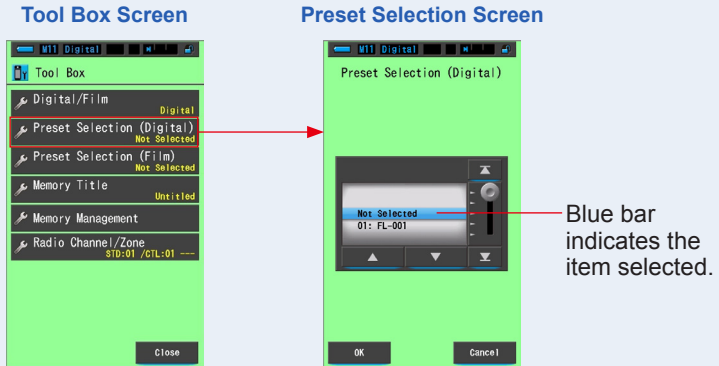

NOTICE

A Preset value must be created and saved in the Preset Editing function under the "Setting Mode" icon before it can be used.
Preset Selection buttons will be grayed out until settings are created.

2. Select desired preset no. (1 ~ 19).

Touch Up/Down buttons or move slide to position the desired Preset under the blue bar.

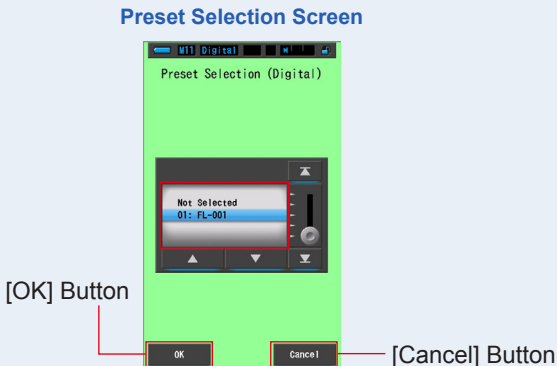

NOTICE

Be sure to set Preset Selection to "Not Selected" when no correction is desired.

3. Touch the [OK] button.

Confirm and return to the Measurement screen.

To return to the Measurement screen without confirming, touch the [Cancel] button.

The selected status will be displayed on the status bar.



The selected preset no. is displayed.

The preset is set.



When selected, the Preset Color Temperature is used by the meter in place of the Target Color Temperature that was selected from the Measuring screen.

6-3 Using the Memory Function

The memory function enables storing light source data for single sources and groups of sources for recall at any time. Up to 99 measurements can be stored. Memory function also enables naming or renaming the title of memory and clearing the stored value.

Memory Management Screen



Tool Box Screen



Memory Title Screen

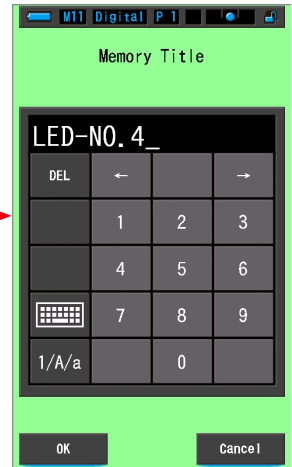

Memory Recall Screen



Memory Edit Screen



Renaming Memory Title

Clearing Memorized Value

6-3-1

Naming Measurement Being Memorized [Memory Title] Screen

You can create special titles for memorized values to make them easier to select, view and use data later.

To use this function the order of operation:

- * Create memory title
- * Measure light source
- * Press Memory button **7** to memorize

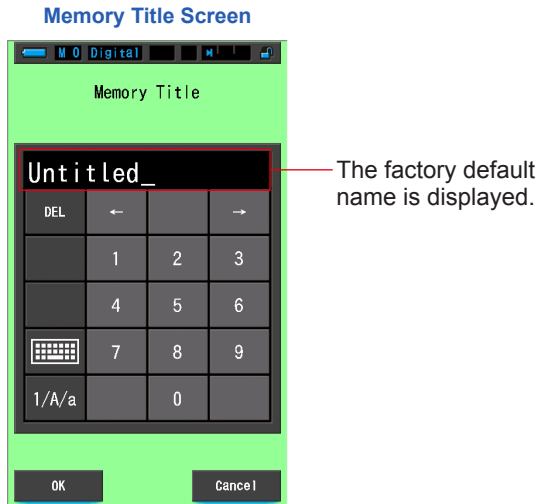

NOTE

- A title can be a maximum of 16 alphanumeric characters.
- Up to 99 titles can be created. More than one measurement can be stored under one title.

Operation

1. Touch and select the [Memory Title] button in the Tool Box.

The Memory Title screen will be displayed.



2. Enter the memory title. (→ P19)

Use the keyboard to create a name for the measured light.

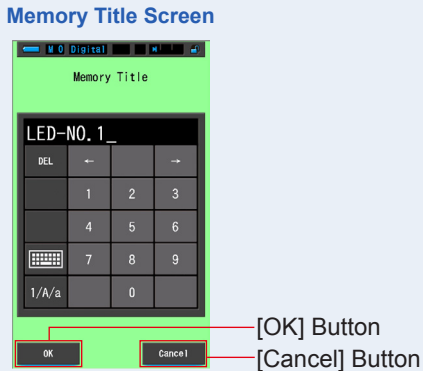

3. Touch the [OK] button.

Confirm and return to the Measurement screen.

To return to the Measurement screen without confirming, touch the [Cancel] button.

The memory title is entered.

NOTICE



The memory title needs to be entered before memorizing.

The title can be changed after memorizing in Memory Management function. (→ P107)

4. Measure light.

Press Measuring Button 5 to take a measurement.

The Light Selection Ring 2 should be set to L () when taking ambient light measurements.

When measuring flash units, select Range L () or Range H () depending on the brightness of the flash. (→ P88, → P90)

Light Selection Ring 2



Measuring Button 5

Measurement screen

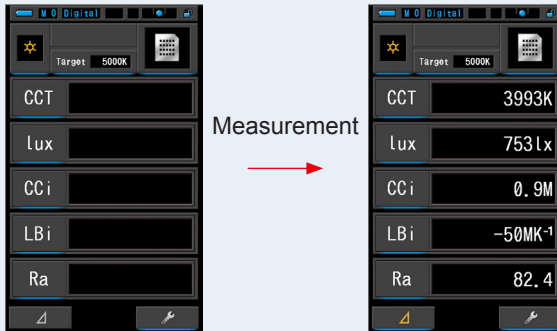

5. Press Memory Button 7 to memorize light source values and link the reading to the created title name.

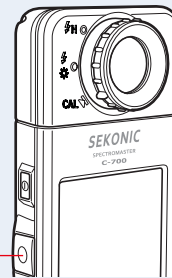

Memory Button 7

6-3-2 Recalling Measurement Results [Memory Recall] Screen

The Memory Recall screen enables selecting a specific Title and Memory number to view and inspect values stored in the memory under the specific combination.

Memory Recall Spectrum Screen

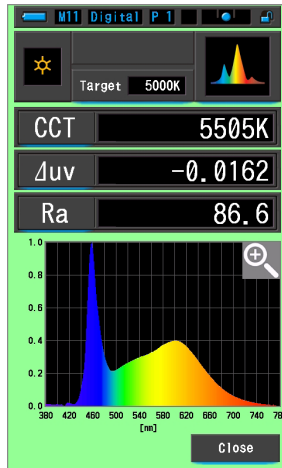

Operation

1. Touch the [Memory Management] button in the Tool Box.
Memory Management screen will be displayed.
2. Select the "Title" and "Memory" to recall with the blue background positions.

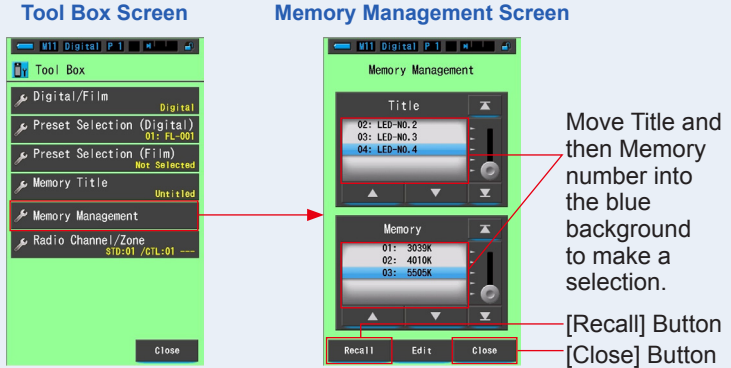

3. Touch the [Recall] button.

The meter will display the display mode viewed when the light source was memorized.

To return to the Measurement screen without confirming, touch the [Close] button.

4. Confirm the memory contents.

Display Mode at the time when memorized appears.

In Memory Recall Mode, the background color becomes green.

Memory Title of recalled value appears every two seconds on the status bar.

Ex.)

Memory Recall Mode Spectrum Screen

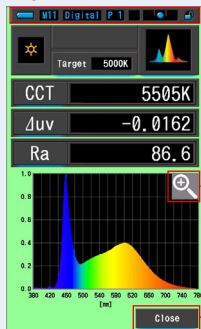

Spectrum Distribution Graph Enlarged Display

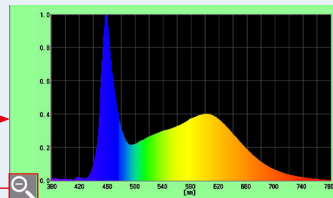

 **NOTICE**

- Only the current reading can be memorized in the [Spectrum Comparison] Mode. If the Spectrum Comparison screen is displayed when the memory button is pressed, the stored data will be displayed on the Spectrum display screen.
- In Memory Recall Mode, measurement cannot be made.





5. Touch the [Close] button.

Returns to the Measurement screen.

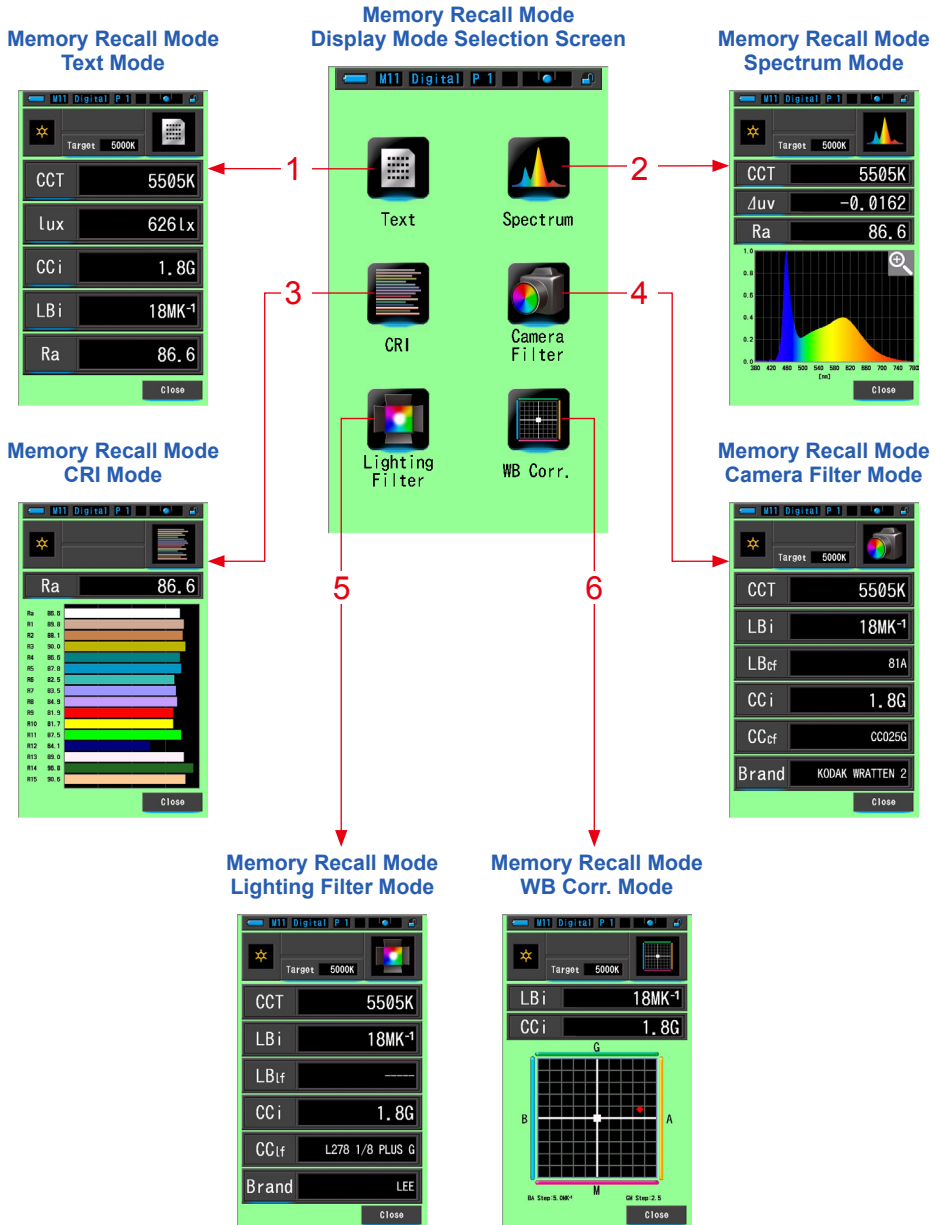
Changing Memory Recall Mode Display

Touch one of the [Display Mode] icons in Memory Recall Mode, and the specified display with memorized data for that Memory Recall Mode will appear.

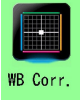

No.	Display Mode Icon	Part Name	Description
1	 Text	Memory Recall Mode [Text] Icon	Displays user-selected 5 items in numeric values. (➡ P33)
2	 Spectrum	Memory Recall Mode [Spectrum] Icon	Displays 3 user-selected values and spectrum distribution graph. (➡ P36)
3	 CRI	Memory Recall Mode [CRI] Icon	Displays the selected average CRI (RA) or individual CRI (R1 ~ R15). Each CRI is displayed in a bar graph. (➡ P43)
4	 Camera Filter	Memory Recall Mode [Camera Filter] Icon	Displays correction values and camera filter names required to adjust measured source to Target Color temperature. (➡ P45)
5	 Lighting Filter	Memory Recall Mode [Lighting Filter] Icon	Displays correction values and light-source filter names required to adjust measured source to Target Color temperature. (➡ P48)
6	 WB Corr.	Memory Recall Mode [WB Corr.] Icon	Displays the difference between the current measurement value and the reference color temperature in a white balance graph. (➡ P57)



NOTE

The contents of Memory Recall Mode display the selected display items in the current Measurement Screen instead of display items at the time when memorized.

Operation

1. Touch the [Display Mode] icon on the Memory Recall Mode.

Display modes of Memory Recall Mode will be displayed. Memory Title of recalled value appears every two seconds on the status bar.

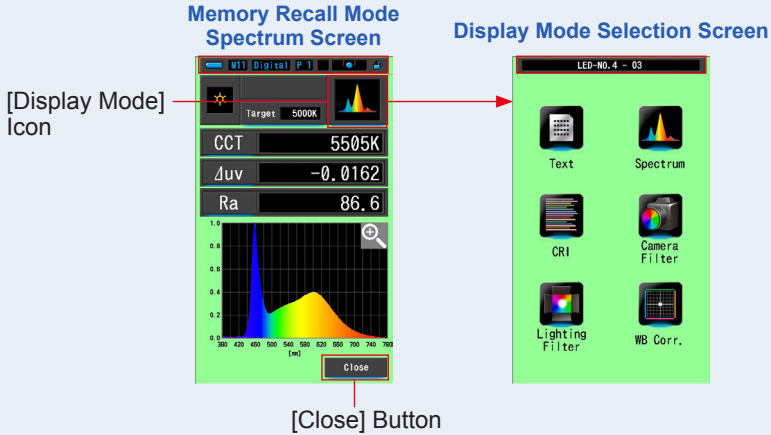

2. Touch the desired [Display Mode] icon to display.

Switches to each display mode screen.

3. Touch the [Close] button.

Returns to the Measurement screen.

6-3-3

Renaming Memory Title [Memory Rename] Screen

The title of measurements of the memory can be changed.

Memory Rename Screen

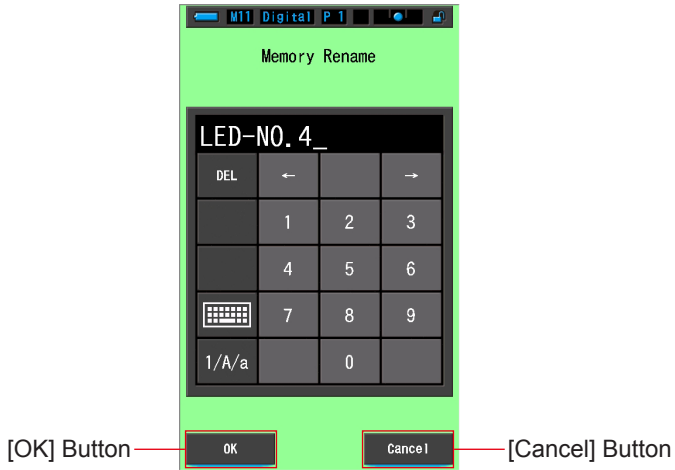

Operation

1. Touch the [Memory Management] button in the Tool Box.
Memory Management screen will be displayed.

Tool Box Screen



Memory Management Screen

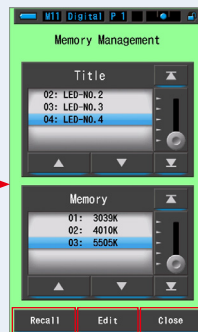

2. Touch the [Edit] button.

Memory Edit screen will be displayed.

Memory Management Screen



[Edit] Button

Memory Edit Screen



[Close] Button

[Rename] Button [Clear] Button

3. Select the "Title" and "Memory" to rename with the blue background positions.

4. Touch the [Rename] button.

Memory Rename screen will be displayed.

Memory Edit Screen



[Renem]
Button

Memory Rename Screen



5. Enter the Memory Title to rename. (➔ P19)

Use the keyboard to create a name for the memorized value.

Memory Rename Screen

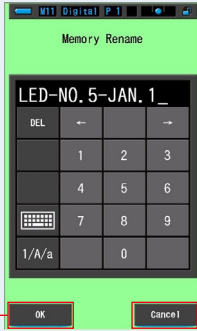

[OK] Button

[Cancel] Button

6. Touch the [OK] button.

Confirm and return to the Memory Edit screen.

To return to the “Memory Edit” screen without confirming, touch the [Cancel] button.

The memory title is entered.

7. Touch the [Close] button.

Close and return to the Memory Management screen. Touch the [Close] button to return to Measuring screen.

Memory Edit Screen



[Close] Button

Memory Management Screen



[Close] Button

6-3-4

Deleting Saved Measurement Results [Memory Clear] Screen

You can delete memorized measurement values individually or all at once. In Memory Clear, titles and memory contents (memory numbers and measurement values) are displayed in the registered order.

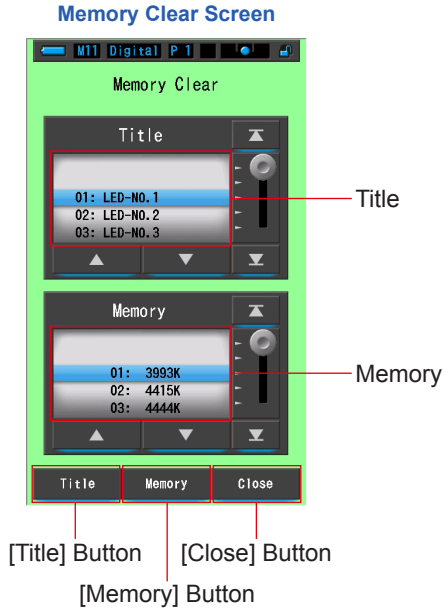

Operation

1. Touch and select the [Memory Management] button in the Tool Box.

The Memory Clear screen will be displayed.

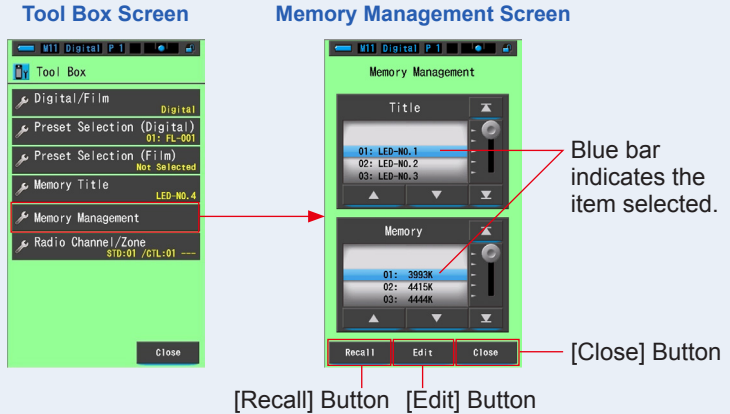

2. Touch the [Edit] button.

Memory Edit screen will be displayed.

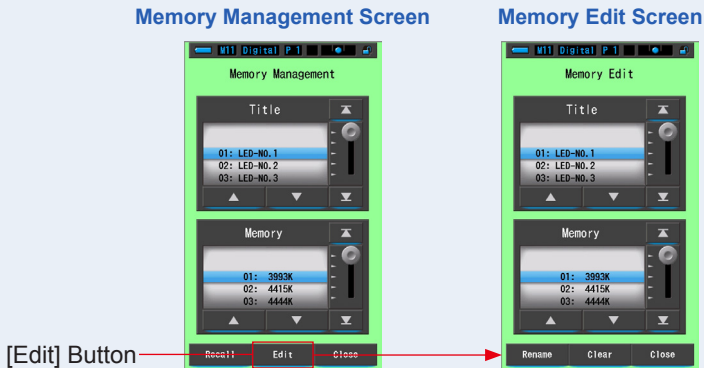

3. Select the "Title" and "Memory" to clear with the blue background positions.

4. Touch the [Clear] button.

Memory Clear screen will be displayed.

Memory Edit Screen



[Clear] Button

Memory Clear Screen

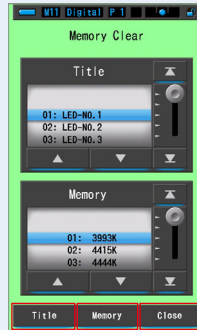

[Close] Button

[Title] Button [Memory] Button

[Erasing Individual Values]

1. Select the Title to display the memorized value you want to delete. Then select the specific light source value under that title, if more than one value has been memorized.

2. Touch the [Memory] button.

This will display the Memory Clear Confirmation screen. "Remove the selected memory data. Are you sure?" will be displayed.

Memory Clear Screen

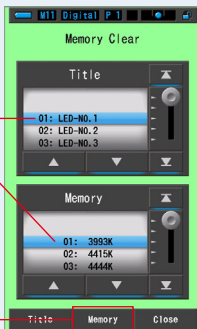

Select Title then the Memory that you want to clear.

[Memory] Button

Memory Clear Confirmation Screen



[Yes] Button

[No] Button

3. Touch the [Yes] button.

A progress bar will appear while the memory is being deleted.

When the memory has been cleared, the meter will return to the Memory Clear Screen.

You can clear (delete) additional memories (stroed data) by repeating steps 1-3.

If you decide not to delete a memory (stored data), touch the [No] button to return to the Memory Clear Screen.

Memory Clear Processing Screen

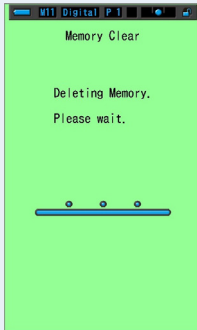

Memory Clear Screen

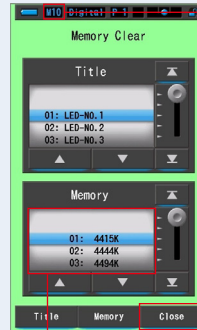

The number of memories will change.

[Close] Button

The selected memory will be deleted, and the numbers after the selected number will decrease by one.

4. Touch the [Close] button.

Returns to the Memory Edit screen.

When you do not delete other memories, touch the [Close] button. Returns to the Memory Edit screen.

[Erasing All]

1. Match the "Title" to be deleted with the blue background positions.

Select the "Title" to be deleted.

2. Touch the [Title] button.

This will delete the title. All the memory data linked to the title will be deleted.

This will display the Memory Clear Confirmation screen. "Remove the selected memory title. Are you sure?" will be displayed.

Memory Clear Screen

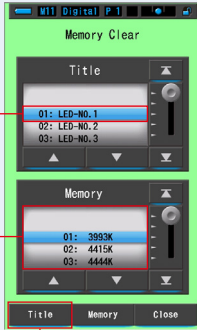

Move title into the blue background to select it.

All memorized measurements linked to the selected title will be displayed.

[Title] Button

Memory Clear Confirmation Screen

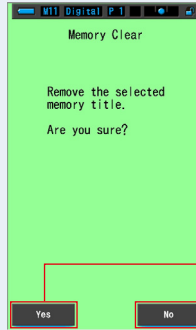

[Yes] Button

[No] Button

3. Touch the [Yes] button.

"Deleting Memory. Please wait." will be displayed. Returns to the Memory Clear screen after deletion.

While the progress bar is running, the deletion is in progress. The process may require time depending on the number of memories to be deleted. Do not perform other work.

When you do not delete the memories, touch the [No] button. Returns to the Memory Clear screen.

Memory Clear Processing Screen

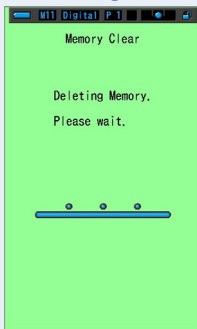

Memory Clear Screen

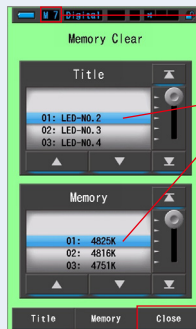

The number of memories will change.

After the selected memory and its linked data is deleted, the contents of title 01 are displayed.

[Close] Button

4. Touch the [Close] button.

Returns to the Memory Edit screen. Touch the [Close] button until returning to Measuring screen.

6-4

Setting the Radio Channel (C-700R Only)

Set the radio channel/zone to use.

■ Setting ControlTL® Channels

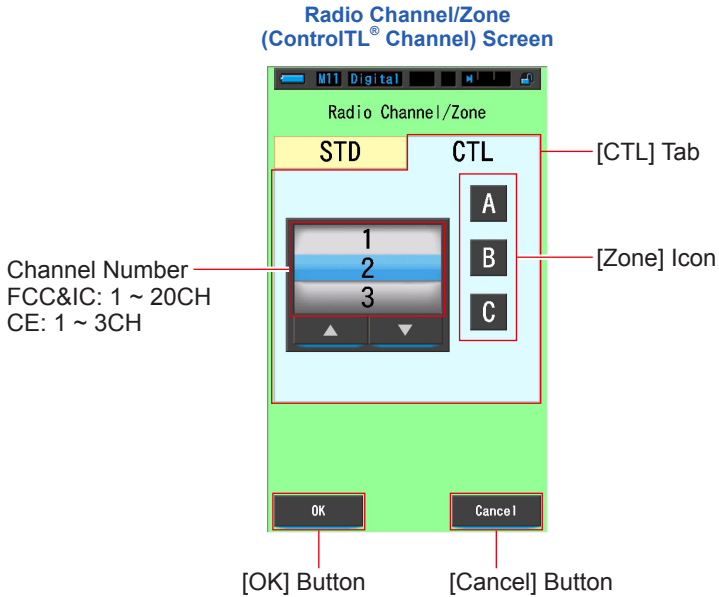

Operation

1. Touch the [Radio Channel/Zone] button in the Tool Box.
The radio channel/zone will be displayed.

2. Touch the [CTL] tab.

When [Radio Channel/Zone] is selected, the [CTL] tab comes forward.

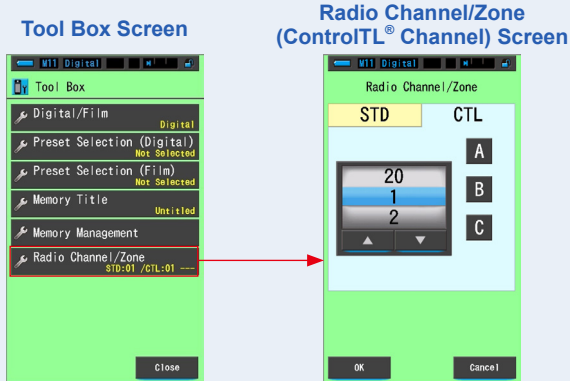

3. Select the channel number. (FCC&IC: 1 ~ 20, CE: 1 ~ 3)

Select the channel number that you want to use.

Radio Channel/Zone (ControlTL Channel) Screen

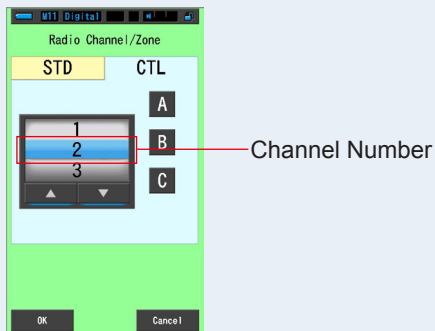

4. Touch the [Zone] icon.

Set one or more zones (A, B, C).

The selected zones will be displayed and encircled in blue.

Radio Channel/Zone (ControlTL® Channel) Screen

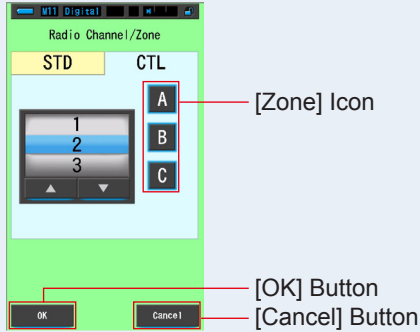

5. Touch the [OK] button.

Confirm and return to the Measurement screen.

To return to the Measurement screen without confirming, touch the [Cancel] button.

6. Confirm the set channel and zones on the Measurement screen.

You can see the settings on the button at the lower left hand corner.

Measurement screen

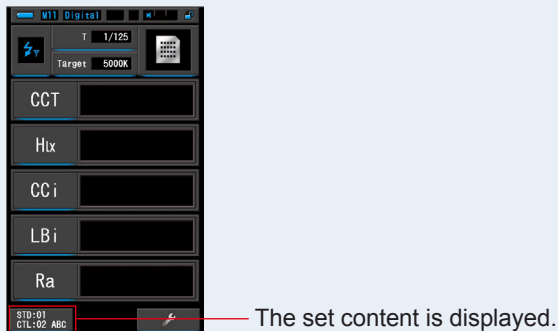

The ControlTL® channel and zones are set.

■ Setting Standard Channels

Radio Channel/Zone (Standard Channel) Screen

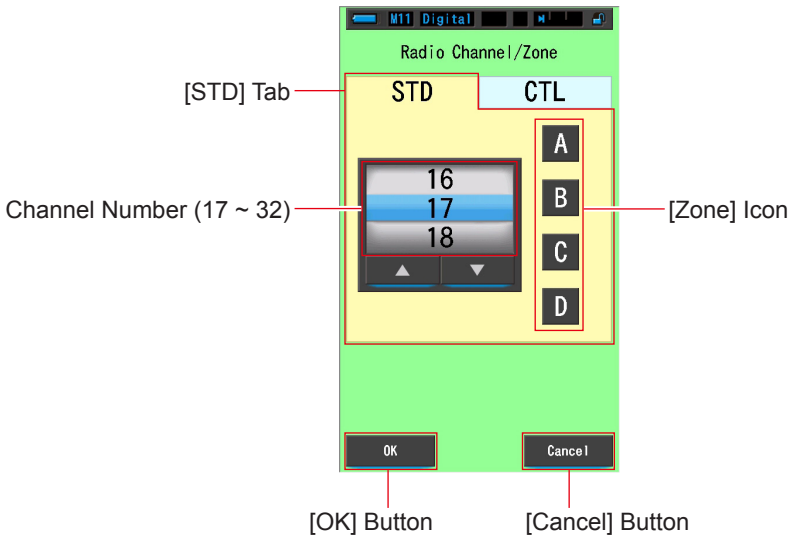
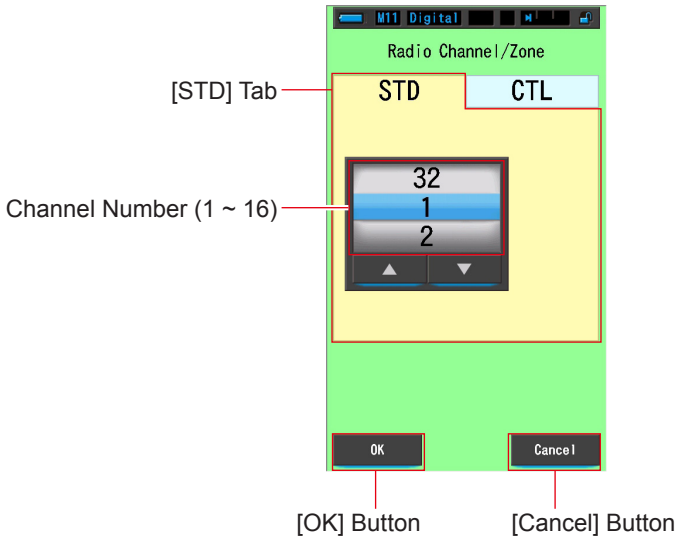

Operation

1. Touch the [Radio Channel/Zone] button in the Tool Box.
The radio channel/zone will be displayed.

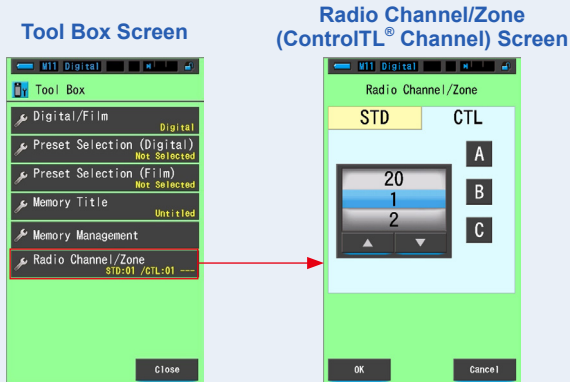

2. Touch the [STD] tab.
Standard channels will be displayed.

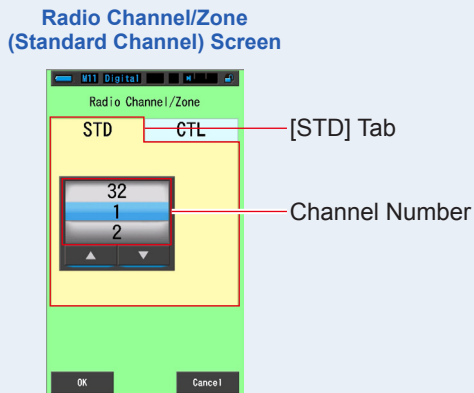

3. Select the channel number (1 ~ 32).

Select the channel number that you want to use.

Radio Channel/Zone (Standard Channel) Screen

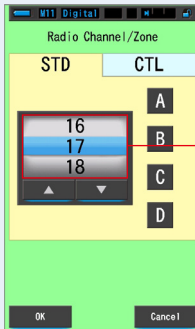

Channel Number (1 ~ 32)

4. Touch the [Zone] icon.

When a channel number is set to 17 to 32, zones (A, B, C, D) will appear to select.

Select the zone to trigger the flash.

Channel 1 to 16: No zone setting

Channel 17 to 32: Up to 4 (A, B, C, D) can be set.

The selected zone will be displayed and encircled in blue.

Radio Channel/Zone (Standard Channel) Screen

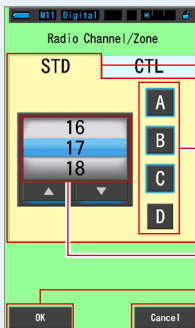

[STD] Tab

[Zone Number] Icon

Channel Number (17 ~ 32)

[OK] Button

[Cancel] Button

5. Touch the [OK] button.

Confirm and return to the Measurement screen.

To return to the Measurement screen without confirming, touch the [Cancel] button.

6. Confirm the set channel and zones on the Measurement screen.

You can see the settings on the button at the lower left hand corner.

Measurement screen



The set content is displayed.

The Standard channel is set.



NOTE

- Touching the [Radio Channel/Zone] button on the Measurement screen will display the Radio Channel/Zone screen. The background color is black.
- When shifted to the Radio Channel/Zone screen by the [Radio Cancel/Zone] button, touch the [OK] button or [Cancel] button to return to the Measurement screen.

Measurement Screen



Radio Channel/Zone (ControlTL® Channel) Screen

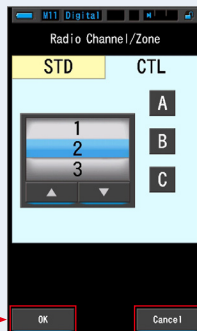

[OK] Button [Cancel] Button

Radio Channel/Zone (Standard Channel) Screen

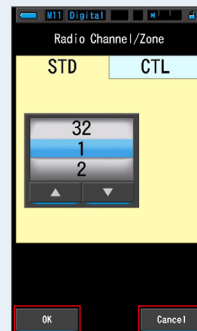

[OK] Button [Cancel] Button

- When you set Radio Channel/Zone from either screen, the last settings are reflected on both screens.

7. Meter Settings [Setting] Screen

7-1 Setting Items

Here you can customize your meter for your preference in advance.

Display Mode Selection Screen

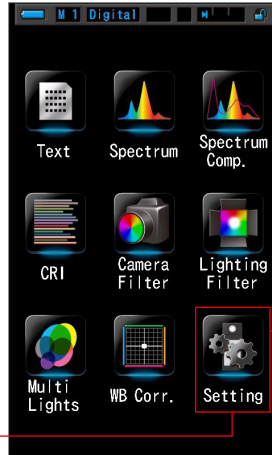

[Setting] Icon

Setting Page 1 Screen

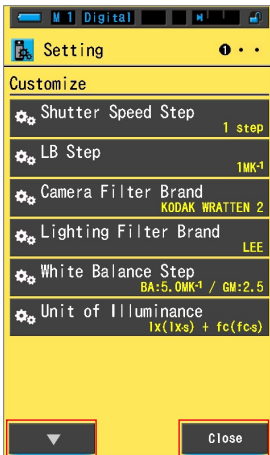

*1

To page 2

Setting Page 2 Screen

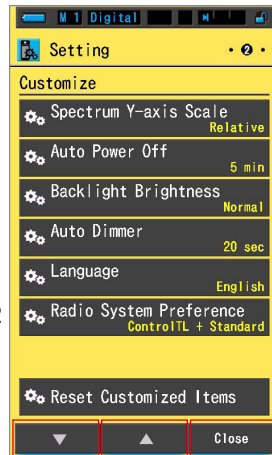

*2

To page 1 To page 3

Setting Page 3 Screen



To page 2

[Close] Button

*1: Models sold in some countries do not display illuminance and exposure in "fc (fc·s)" due to legal restrictions. In this case, Unit of Illuminance is not displayed.

*2: Indicated only for C-700R model.

Operation

1. Touch the [Setting] icon on the Display Mode screen.

Setting will be displayed.

2. Touch the one step icons [▲][▼] to display the desired page.

3. Touch the desired setting name.

That setting screen will be displayed.

When the [Close] button is touched, the display returns to the Display Mode Selection screen.

7-1-1 Item List

The Setting screen items are as follows.

Item Name	Description
Customize	
Shutter Speed Step	Select the shutter speed from 1 step, 1/3 step, and 1/2 step. (➔ P127)
LB Step	Select the LB index display step from 1MK^{-1} , 1daMK^{-1} (no decimal point) step, and 0.1daMK^{-1} (with decimal point) step. (➔ P130)
Camera Filter Brand	Select KODAK WRATTEN 2, FUJIFILM or LEE as the camera filter brand. (➔ P132)
Lighting Filter Brand	Select LEE, ROSCO CINEGEL or ROSCO E-COLOUR+ as the lighting filter brand. (➔ P134)
White Balance Step	Set the step for 1 grid square on the WB Corr. screen from the ranges below. BA: $0.5 \sim 100.0\text{MK}^{-1}$ GM: $0.5 \sim 20.0$. (➔ P136)
Unit of Illuminance*	Select the unit from lx(lx·s), fc(fc·s) or both when measuring illuminance. (➔ P138)
Spectrum Y-axis Scale	Select relative, auto, or spectral radiant intensity. (➔ P140)
Auto Power Off	Select the time before the power automatically turns off after last use (5min, 10min, 20min, No Auto Power Off). When No Auto Power Off is set, the automatic power OFF function is not activated. (➔ P143)
Backlight Brightness	Select the LCD backlight brightness from dark, normal, or bright. (➔ P145)
Auto Dimmer	Select the time before the backlight dims after last use to save extra power or adjust the visibility under the surrounding light condition. (20sec, 40sec, 60sec, No Dimmer) (➔ P147)
Language	Select the language displayed on the touch panel from English, Japanese or Chinese. (➔ P149)
Radio System Preference (for C-700R only)	Select from ControlTL, Standard, Control TL + Standard, or Not in Use. (➔ P151)
Reset Customized Items	Initialize (reset) only contents of "Customize" in Setting to the factory default (11 items for C-700 and 12 items for C-700R). (➔ P153)
Edit a preset	
Preset Editing	Edit a preset for film or digital separately. (➔ P154)
Dark Calibration	
Dark Calibration	Perform a dark calibration. (➔ P168)
Display the information	
Product Information	Display the product Information. (➔ P171)
Regulation	Display the complied regulations or certifications. (➔ P173)

* Models sold in some countries do not display illuminance and exposure in "fc (fc·s)" due to legal restrictions.

7-2

Customize

You can set the display contents of 11 items (C-700), 12 items (C-700R) in Customize (P1 to 2 of Setting) to customize your meter for your preference. The current setting for each item is displayed in yellow letters.

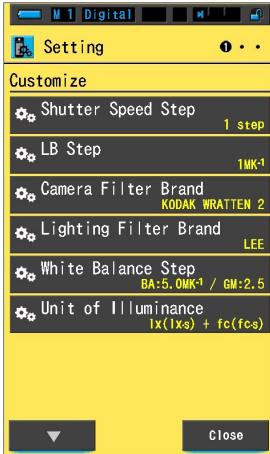
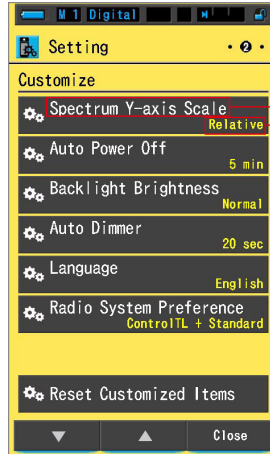
Setting
Page 1 ScreenSetting
Page 2 Screen

Item
(white letters)

Current Setting
Value
(yellow letters)

Operation

1. Touch the [Setting] icon on the Display Mode screen.
Setting will be displayed.
2. Touch the one step icons [\blacktriangle][\blacktriangledown] to display the desired page.
3. Touch the desired item.
The item screen will be displayed.
When the [Close] button is touched, the display returns to the Display Mode Selection screen.

7-2-1 Item Specifications

The specifications of each "Customize" item is as follows.

No.	Setting Name	Item				
						(Default)
1	Shutter Speed Step	1 Step	1/3 Step	1/2 Step	-	1 Step
2	LB Step	1MK ⁻¹ Step	1daMK ⁻¹ Step	0.1daMK ⁻¹ Step	-	1MK ⁻¹ Step
3	Camera Filter Brand	KODAK WRATTEN 2	FUJIFILM	LEE	-	KODAK WRATTEN 2
4	Lighting Filter Brand	LEE	ROSCO CINEGEL	ROSCO E-COLOUR+	-	LEE
5	White Balance Step	BA: 0.5 to 100.0MK ⁻¹ GM: 0.5 to 20.0				BA: 5MK ⁻¹ GM: 2.5
6	Unit of Illuminance*	lx(lx·s)+ fc(fc·s)	lx(lx·s)	fc(fc·s)	-	lx(lx·s)+ fc(fc·s)
7	Spectrum Y-axis Scale	Relative	Auto	Spectral Radiant Intensity 1.0μW to 100W·m ⁻² ·nm ⁻¹		Relative
8	Auto Power Off	5min	10min	20min	No Auto Power Off	5min
9	Backlight Brightness	Dark	Normal	Bright	-	Normal
10	Auto Dimmer	20sec	40sec	60sec	No Dimmer	20sec
11	Language	English	Japanese	Chinese	-	Selected by default
12	Radio System Preference	ControlTL	Standard	ControlTL +Standard	Not in Use	ControlTL +Standard
13	Reset Customized Items	When you touch the [OK] button, the Setting contents will be reset to factory default.				-

* Models sold in some countries do not display illuminance and exposure in "fc (fc·s)" due to legal restrictions.



NOTE

- 1MK⁻¹ is equivalent to 1Mired.
- The unit "MK⁻¹" is now used based on the International System of Units (SI) instead of traditional unit "Mired". The latest unit is adopted to the Spectromaster C-700/700R.

7-2-2

Selecting the Shutter Speed Step

Select the shutter speed from 1 step, 1/3 step, and 1/2 step.

Shutter Speed Step Screen

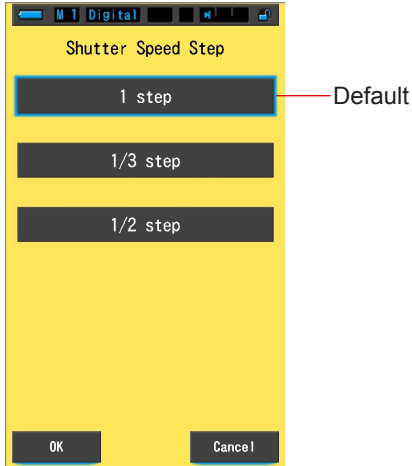

Selectable Shutter Speeds (in seconds)

1 Step (Default)	1, 1/2, 1/4, 1/8, 1/15, 1/30, 1/60, 1/125, 1/250, 1/500, 1/75, 1/80, 1/90, 1/100, 1/200, 1/400
1/3 Step	1, 0.8, 0.6, 0.5, 0.4, 0.3, 1/4, 1/5, 1/6, 1/8, 1/10, 1/13, 1/15, 1/20, 1/25, 1/30, 1/40, 1/50, 1/60, 1/80, 1/100, 1/125, 1/160, 1/200, 1/250, 1/320, 1/400, 1/500, 1/75, 1/80, 1/90, 1/100, 1/200, 1/400
1/2 Step	1, 0.7, 1/2, 1/3, 1/4, 1/6, 1/8, 1/10, 1/15, 1/20, 1/30, 1/45, 1/60, 1/90, 1/125, 1/180, 1/250, 1/350, 1/500, 1/75, 1/80, 1/90, 1/100, 1/200, 1/400

Operation

1. Touch the item [Shutter Speed Step] button on page 1 of Setting.
The shutter speed step will be displayed.

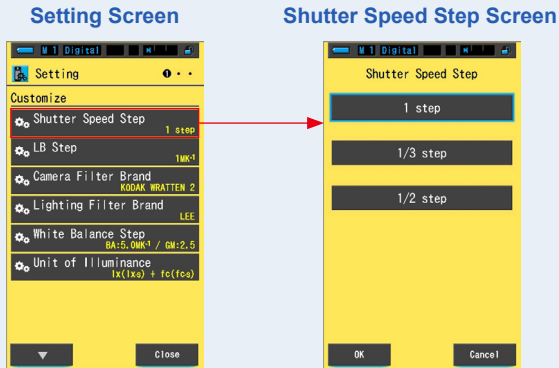

2. Touch the desired shutter speed step to use.
Select from 1 step, 1/3 step, or 1/2 step.

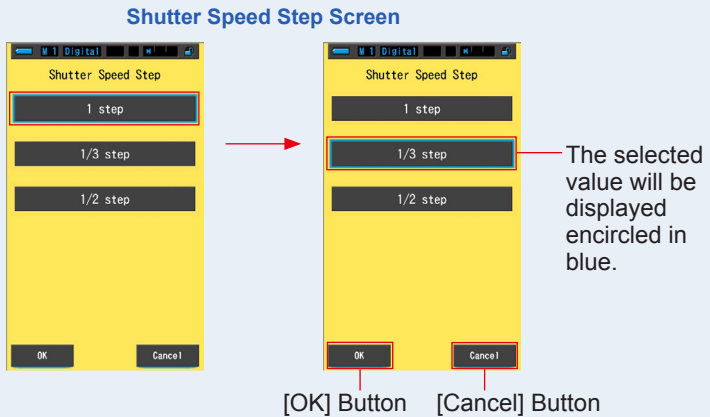

3. Touch the [OK] button.

Confirms the settings, and returns to Setting.

To return to Setting without confirming, touch the [Cancel] button.

Setting Screen

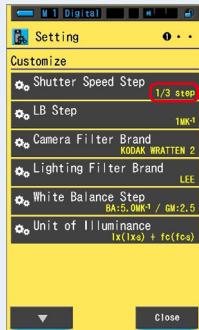

The set content is displayed.

The shutter speed step is set.

7-2-3 Selecting the LB Step

Select the LB index display step from 1MK^{-1} , 1daMK^{-1} (no decimal point) step, and 0.1daMK^{-1} (with decimal point) step.

Ex) 38MK^{-1} is displayed as 38MK^{-1} in 1MK^{-1} step, 4MK^{-1} in 1daMK^{-1} step, and 3.8MK^{-1} in 0.1daMK^{-1} step.

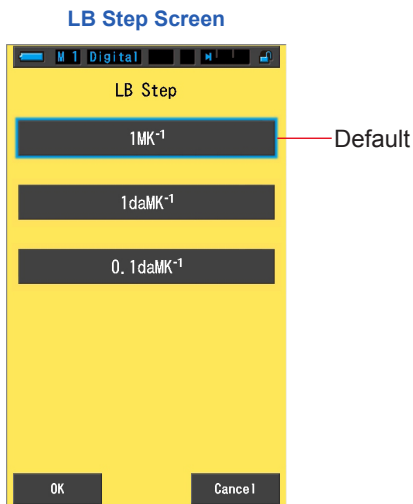

Operation

1. Touch the item [LB Step] button on page 1 of Setting.
The LB step will be displayed.

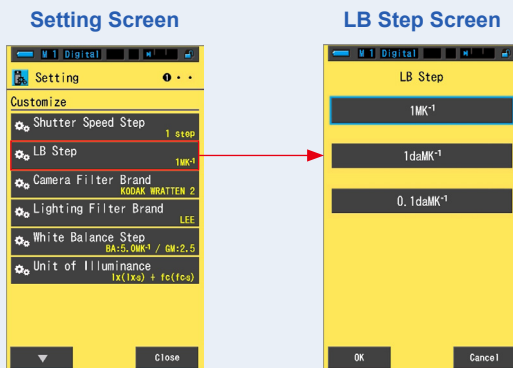

2. Touch the desired LB step value to use.

Select the LB Step value.

LB Step Screen

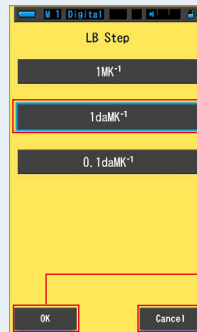
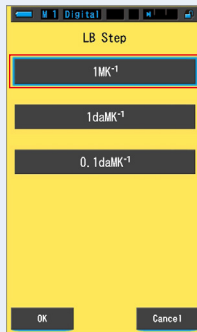

The selected value will be displayed encircled in blue.

[OK] Button

[Cancel] Button

Measurement Screen Display Example



3. Touch the [OK] button.

Confirms the settings, and returns to Setting.

To return to Setting without confirming, touch the [Cancel] button.

Setting Screen

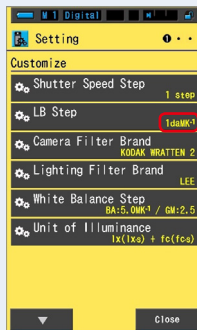

The set content is displayed.

The LB step is set.



NOTE

- 1MK^{-1} is equivalent to 1Mired.
- The unit " MK^{-1} " is now used based on the International System of Units (SI) instead of traditional unit "Mired". The latest unit is adopted to the Spectromaster C-700/700R.

7-2-4

Selecting the Camera Filter Brand

Select KODAK WRATTEN 2, FUJIFILM or LEE as the camera filter brand.

Camera Filter Brand Screen

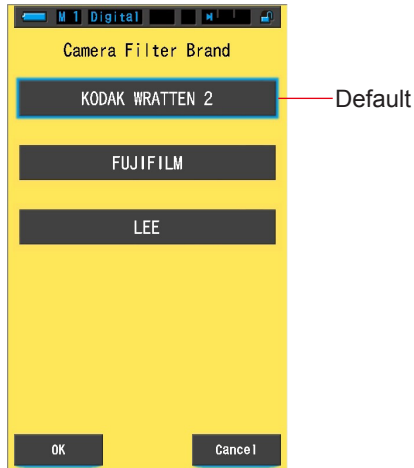

Operation

1. Touch the item [Camera Filter Brand] button on page 1 of Setting.
The camera filter brand will be displayed.

Setting Screen

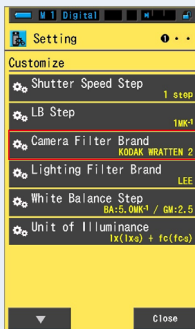

Camera Filter Brand Screen

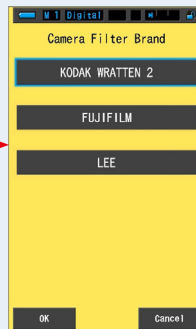

2. Touch the desired camera filter brand to use.

Select the filter brand of the camera used.

Camera Filter Brand Screen

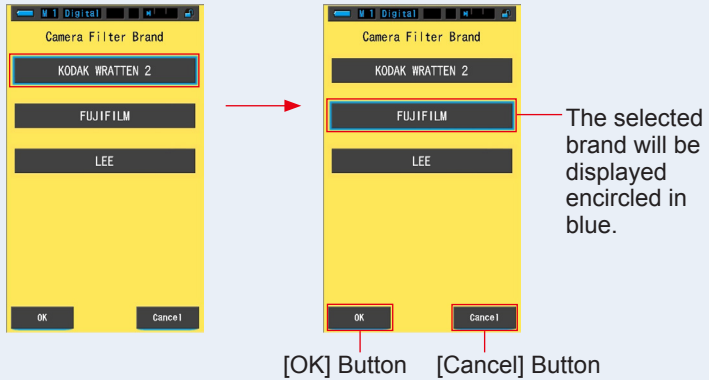

3. Touch the [OK] button.

Confirms the settings, and returns to Setting.

To return to Setting without confirming, touch the [Cancel] button.

Setting Screen

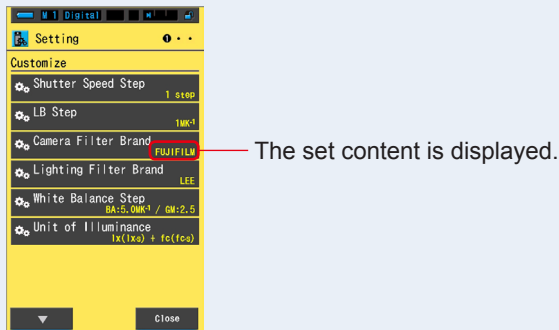

The camera filter brand is set.

7-2-5

Selecting the Lighting Filter Brand

Select LEE, ROSCO CINEGEL, or ROSCO E-COLOUR+ as the lighting filter brand.

Lighting Filter Brand Screen

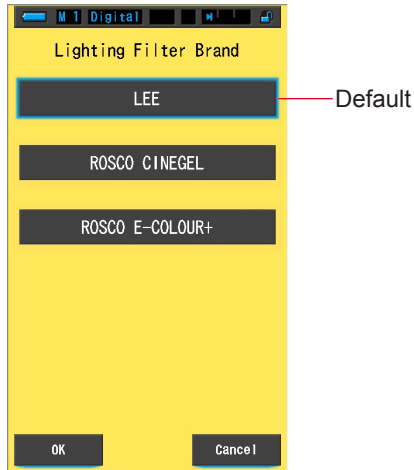

Operation

1. Touch the [Lighting Filter Brand] button on page 1 of Setting.
The lighting filter brand will be displayed.

Setting Screen

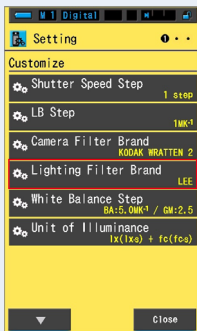

Lighting Filter Brand Screen

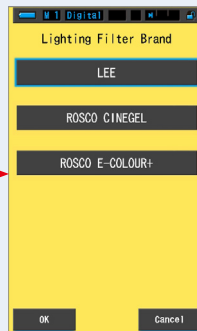

2. Touch the desired filter brand to use.

Select the filter brand of the lighting used.

Lighting Filter Brand Screen

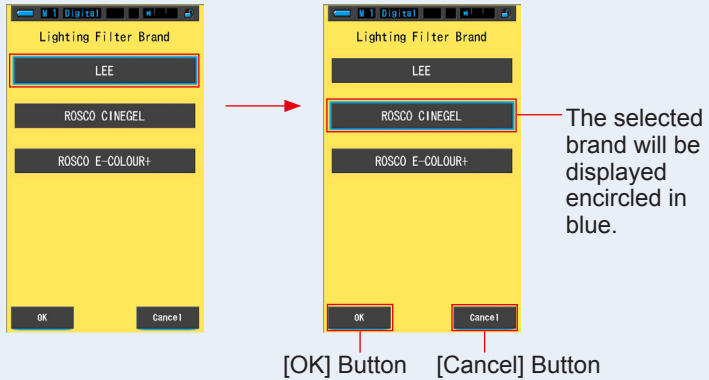

3. Touch the [OK] button.

Confirms the settings, and returns to Setting.

To return to Setting without confirming, touch the [Cancel] button.

Setting Screen



The lighting filter brand is set.

7-2-6

Selecting the White Balance Step

Select the unit per step displayed per grid cell on the WB Corr. Mode measurement screen from a range of BA: 0.5 to 100.0MK⁻¹, GM: 0.5 to 20.0.

White Balance Step Screen

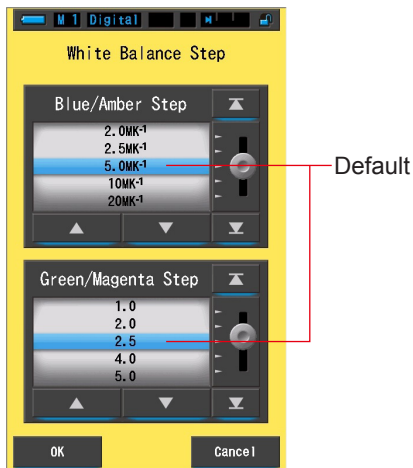

Operation

1. Touch the item [White Balance Step] button on page 1 of Setting. The white balance step will be displayed.

Setting Screen

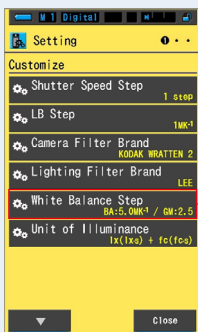

White Balance Step Screen

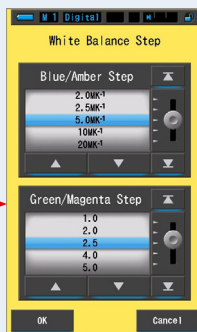

2. Select the desired white balance step to use.

White Balance Step Screen

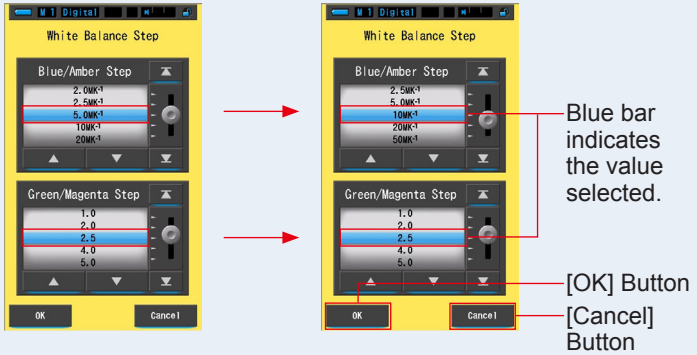

Measurement Screen Display Example

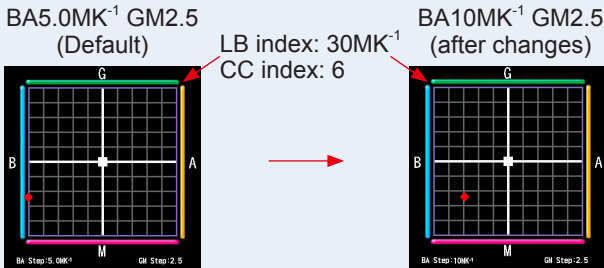

3. Touch the [OK] button.

Confirms the settings, and returns to Setting.

To return to Setting without confirming, touch the [Cancel] button.

Setting Screen

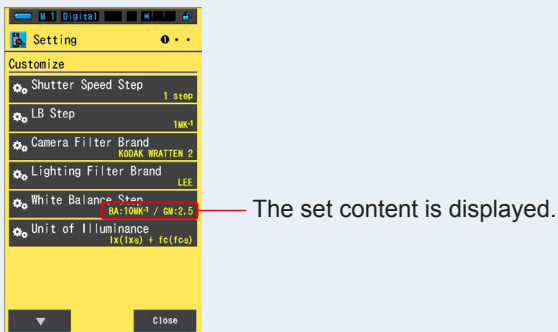

The white balance step is set.

7-2-7

Selecting the Unit of Illuminance

Select the unit when measuring illuminance.

* Models sold in some countries do not display illuminance and exposure in "fc (fc·s)" due to legal restrictions. In this case, "Unit of Illuminance" button will not appear in Setting screen.

Unit of Illuminance Screen

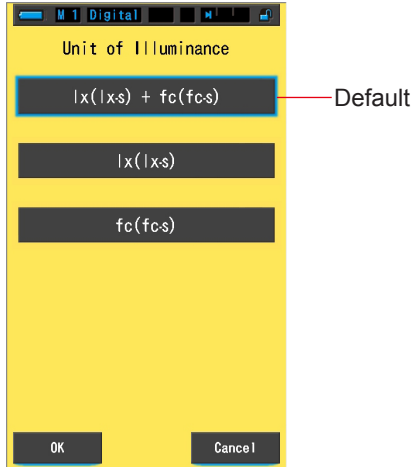

Operation

1. Touch the item [Unit of Illuminance] button on page 1 of Setting Screen.

The unit of illuminance will be displayed.

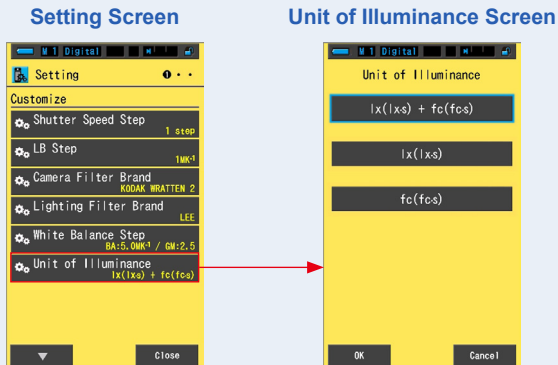

2. Touch the desired unit to use.

Select the unit of illuminance.

Unit of Illuminance Screen

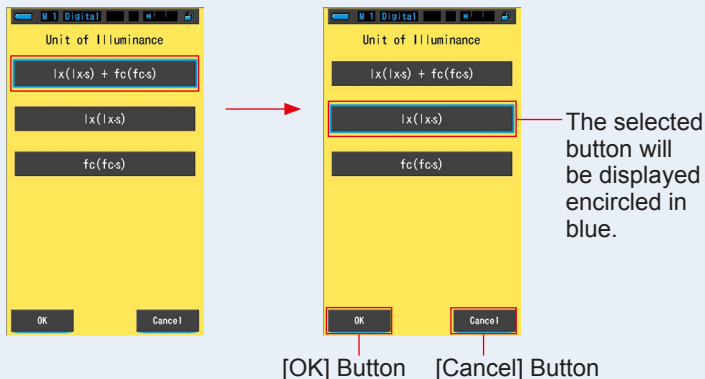

3. Touch the [OK] button.

Confirms the settings, and returns to Setting Screen.

To return to the Setting Screen without confirming, touch the [Cancel] button.

Setting Screen

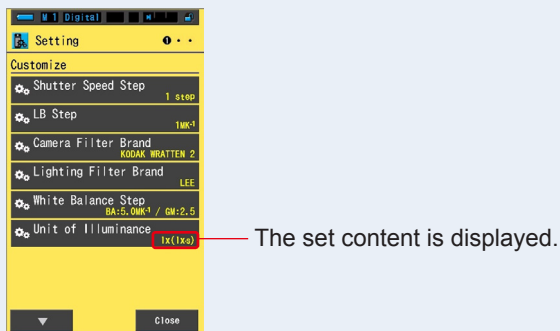

The unit of illuminance is set.

7-2-8

Selecting the Spectrum Y-axis Scale

Select Relative, Auto, or any specific number of spectral irradiance as the maximum display value for the spectrum Y-axis.

Spectrum Y-axis Scale Screen

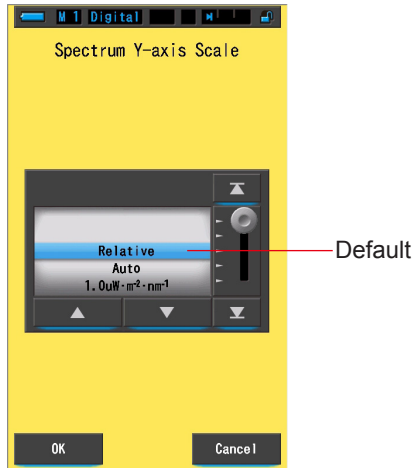

Operation

1. Touch the item [Spectrum Y-axis Scale] button on page 2 of Setting.

The maximum display value of the spectrum Y-axis scale will be displayed.

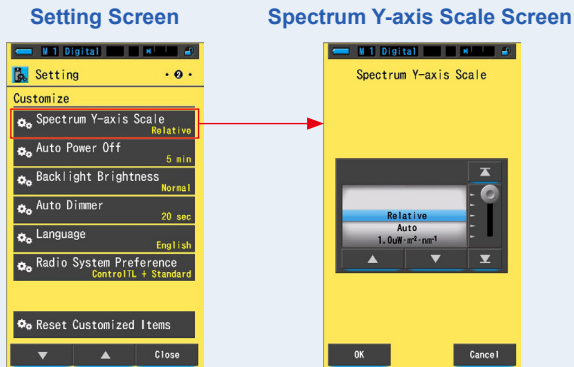

2. Select the desired spectrum Y-axis scale.

Select from relative, auto, or spectral radiant intensity.

Spectrum Y-axis Scale Screen

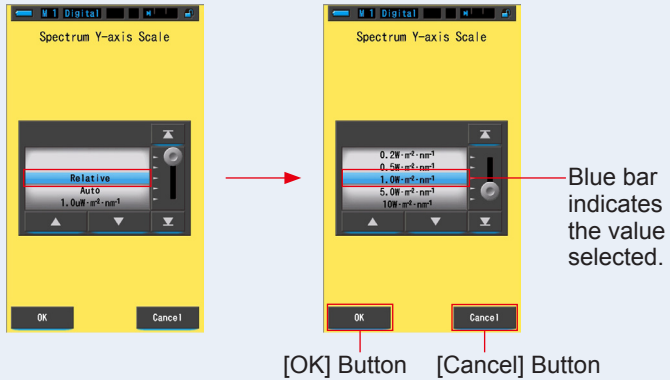

3. Touch the [OK] button.

Confirms the setting, and returns to Setting screen.

To return to Setting screen without confirming, touch the [Cancel] button.

Setting Screen

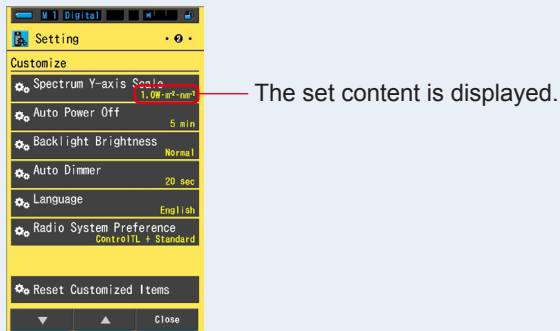

The spectrum Y-axis scale is set.



- Relative.....Regardless of brightness of light source, the peak of brightness in each measurement and memorized values is regarded as 1.0 to compare the light sources in shape of spectrum graph.
- AutoThe appropriate Y-axis value is automatically selected and spectral irradiance can be compared.
- Spectral IrradianceSpecific value can be selected from 1.0u to 100 W·m⁻²·nm⁻¹.

Relative

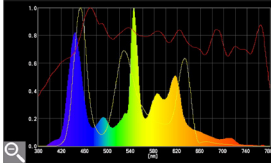

Auto

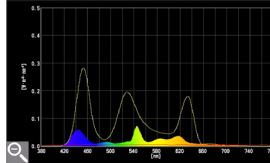

Spectral Irradiance

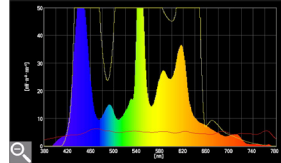

7-2-9

Selecting the Auto Power Off Time

Select the time before the power automatically turns off after last use (5min, 10min, 20min, No Auto Power Off). When No Auto Power Off is set, the automatic power OFF function is not activated.

Auto Power Off Screen

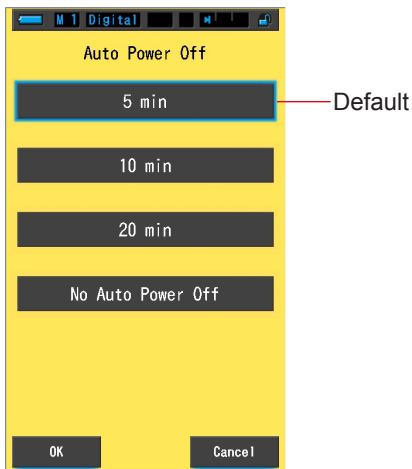

Operation

1. Touch the item [Auto Power Off] button on page 2 of Setting.
The auto power off time will be displayed.

Setting Screen

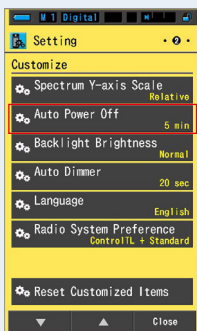

Auto Power Off Screen

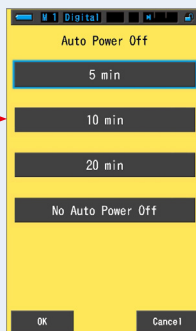

2. Touch the desired time on the Auto Power Off screen.

Select 5min, 10min, 20min, or No Auto Power Off.

Auto Power Off Screen

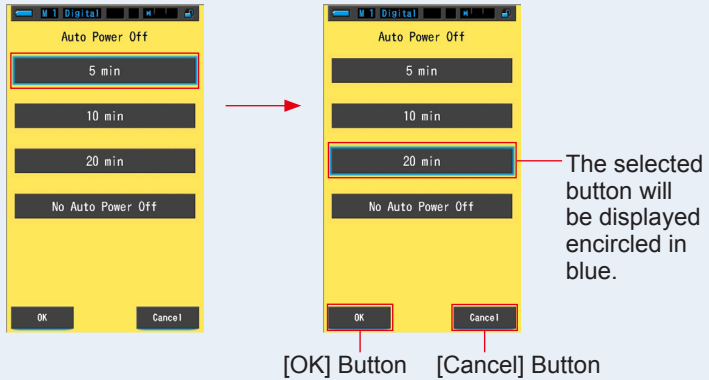

3. Touch the [OK] button.

Confirms the settings, and returns to Setting.

To return to Setting without confirming, touch the [Cancel] button.

Setting Screen

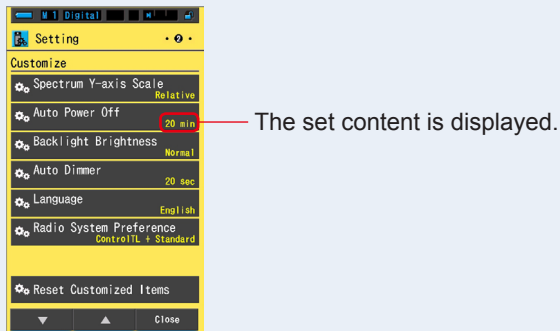

The auto power off time is set.

7-2-10

Selecting the Backlight Brightness

Select the LCD backlight brightness from Dark, Normal or Bright to save extra power or adjust the visibility under the surrounding light condition.

Backlight Brightness Screen



Operation

1. Touch the item [Backlight Brightness] button on page 2 of Setting.

The backlight brightness will be displayed.

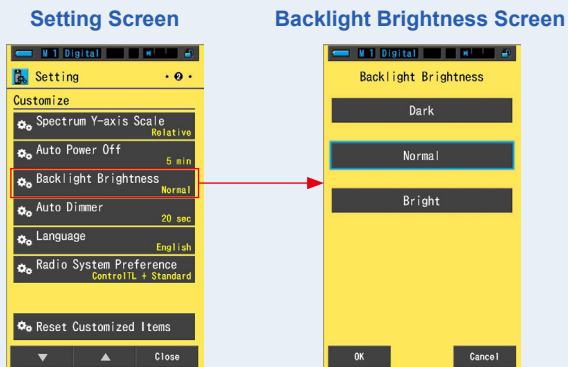

- 2. Touch the desired brightness on the Backlight Brightness screen.**
Select dark, normal or bright.

Backlight Brightness Screen

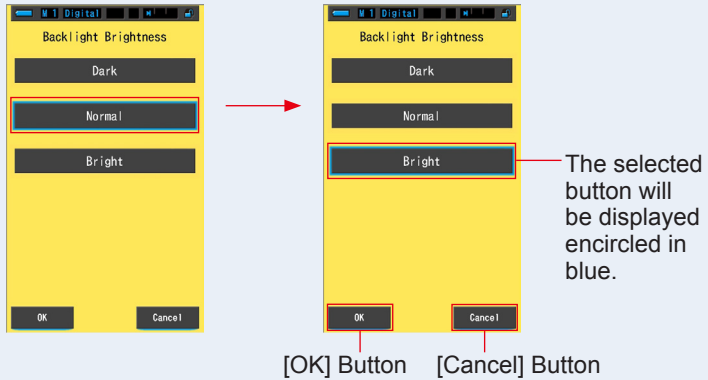

- 3. Touch the [OK] button.**

Confirms the settings, and returns to Setting.

To return to Setting without confirming, touch the [Cancel] button.

Setting Screen

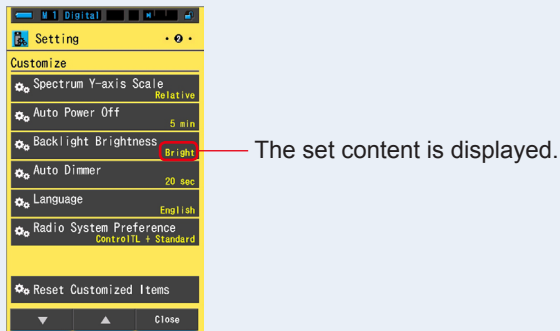

The backlight brightness is set.

7-2-11 Selecting the Auto Dimmer Time

Select the time before the backlight dims after last use to save extra power or adjust the visibility under the surrounding light condition.
(20sec, 40sec, 60sec, No Dimmer)

Auto Dimmer Screen

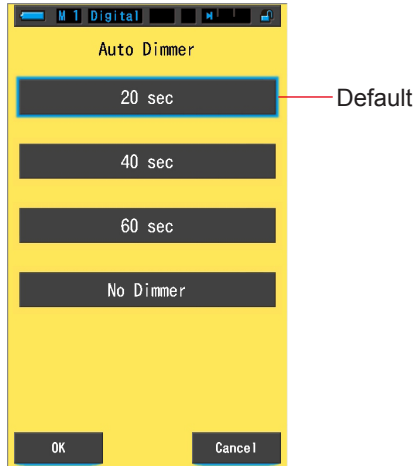

Operation

1. Touch the [Auto Dimmer] button on page 2 of Setting.
The auto dimmer time will be displayed.

Setting Screen

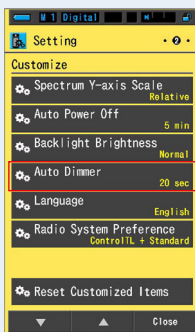

Auto Dimmer Screen

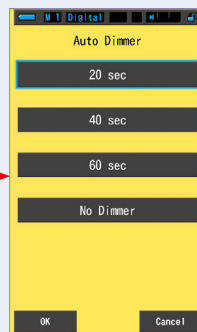

2. Touch the desired time on the Auto Dimmer screen.

Select 20sec, 40sec, 60sec, or No Dimmer.

Auto Dimmer Screen

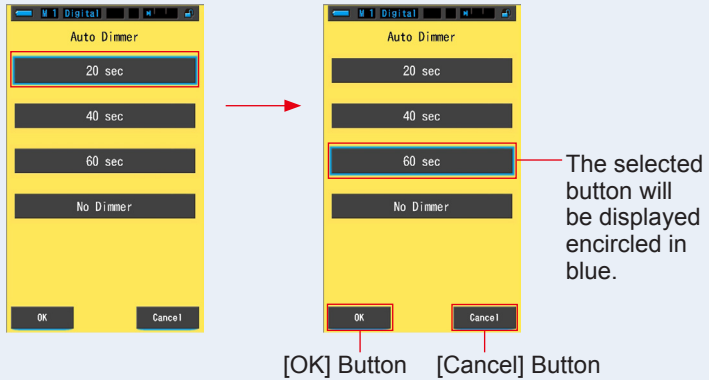

3. Touch the [OK] button.

Confirms the settings, and returns to Setting.

To return to Setting without confirming, touch the [Cancel] button.

Setting Screen

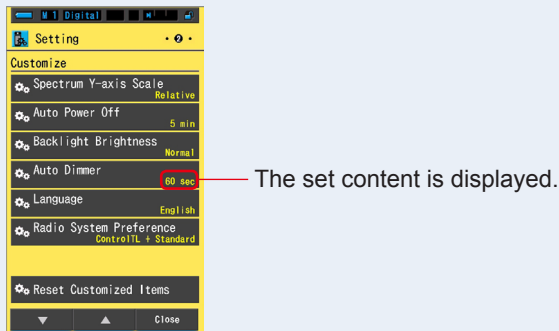

The auto dimmer time is set.

7-2-12 Selecting the Language

Select the language displayed in the meter setting or menu from English, Japanese or Chinese.

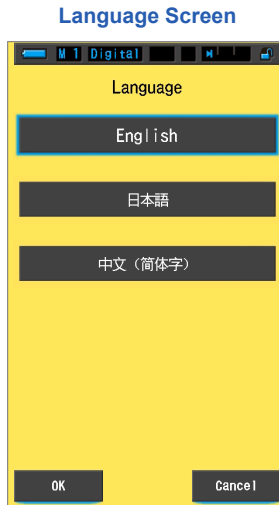

Operation

1. Touch the item [Language] button on page 2 of Setting.
The language will be displayed.

* You can change the language set when power is turned on for the first time.

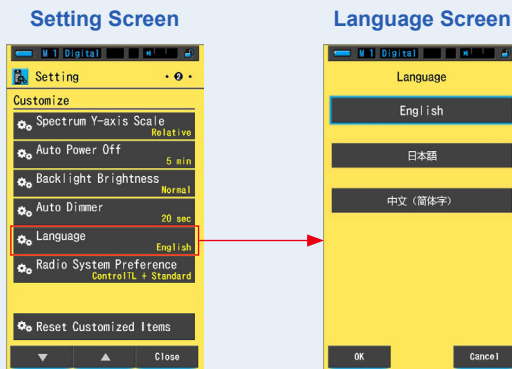

2. Touch the desired language to use.

Select English, Japanese or Chinese.

Language Screen

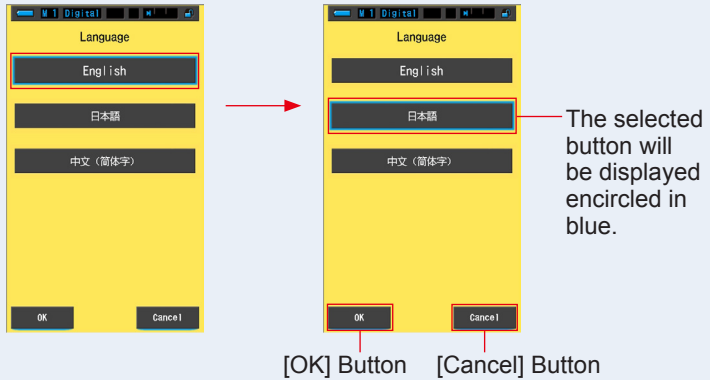

3. Touch the [OK] button.

Confirms the settings, and returns to Setting.

To return to Setting without confirming, touch the [Cancel] button.

Setting Screen

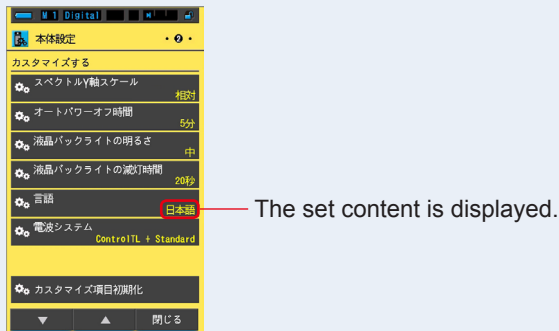

The language is set.

7-2-13 Selecting the Radio System Preference (C-700R Only)

Select from ControlTL, Standard, ControlTL+Standard, or Not in Use as the preference of the Radio Triggering Flash Mode. ControlTL+Standard is default setting.

Radio System Preference Screen

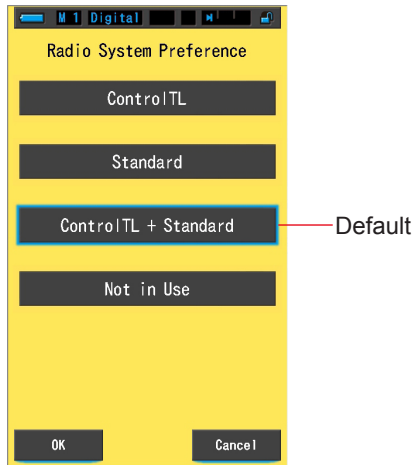

Operation

1. Touch the item [Radio System Preference] button on page 2 of Setting.

The radio system preference type and the Not in Use screen will be displayed.

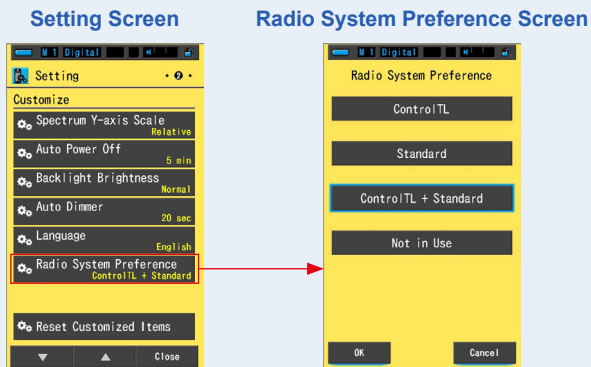

2. Touch the desired system to use.

Select from 4 options. (ControlTL, Standard, ControlTL+Standard, or Not in Use)

Radio System Preference Screen

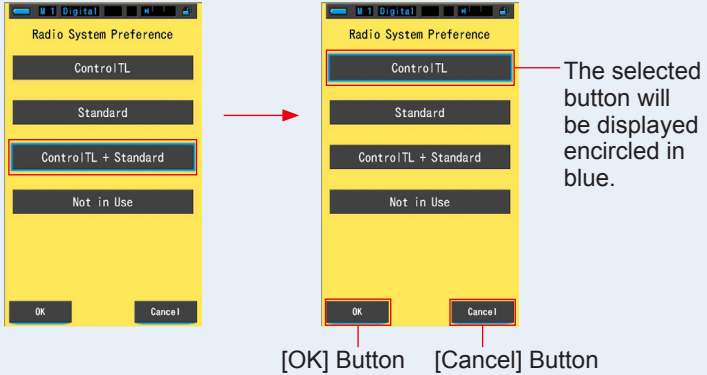

3. Touch the [OK] button.

Confirms the settings, and returns to Setting.

To return to Setting without confirming, touch the [Cancel] button.

Setting Screen

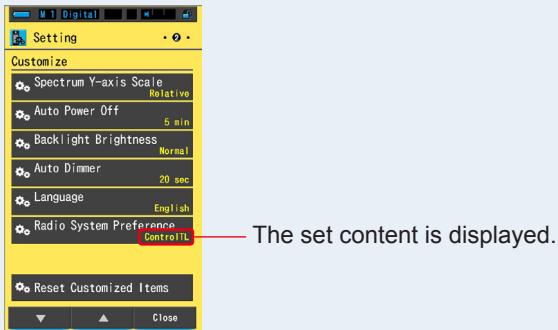

The radio system preference is set.

7-2-14 Reset Customized Items

Initialize (reset) only contents of "Customize" in Setting to the factory default.

Reset Customized Items Screen

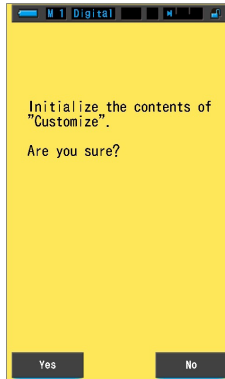

Operation

1. Touch the item [Reset Customized Items] button on page 2 of Setting.

"Initialize the contents of "Customize". Are you sure?" is displayed.

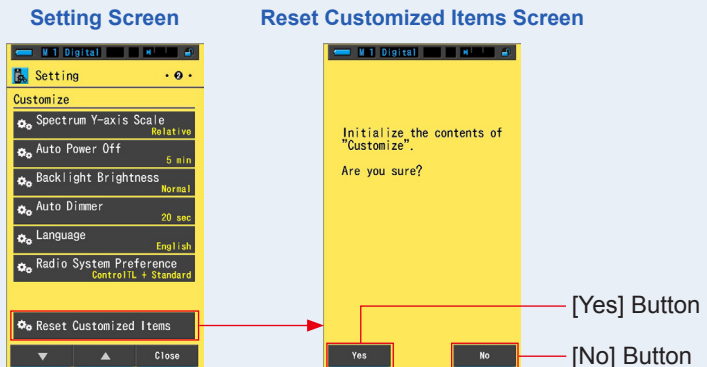

2. Touch the [Yes] button.

Custom settings are reset. After finishing initialization, returns to Setting.

To return to Setting without initializing, touch the [No] button.

7-3 Preset Editing

Presets are a quick way to introduce adjustments to the C-700's camera/light source filter recommendations.

You can create and store Presets for different lighting conditions or color effects to use when ever needed.

The Spectromaster C-700/700R has been calibrated to Sekonic standards. However if the indicated compensating values do not yield the desired or expected color reproduction, than it will be necessary to modify the filter compensation values.

In this case, if you save the compensation values in memory as a preset number and then take measurements, you can display results with the compensated values.

Also, when you use several target color temperatures, you can easily set the target color temperature by recalling one of presents in Tool Box even if you do not input a target color temperature every time.

Depending on the camera used, select either [Preset Editing (Digital)] or [Preset Editing (Film)].

Preset Editing (Digital) Screen

Preset Editing (Digital)

Preset No.
1

Preset Selection List
Hide

Preset Name
Default-D01

Target CCT
5000K

LB Index Correction Value
0Mk⁻¹

CC Index Correction Value
0.0

Close

Preset Editing (Film) Screen

Preset Editing (Film)

Preset No.
1

Preset Selection List
Hide

Preset Name
Default-F01

Target CCT
5000K

LB Index Correction Value
0Mk⁻¹

CC Index Correction Value
0.0

Close



NOTE

Up to 19 presets can be registered for each digital and film.

Operation

1. Touch the item [Preset Editing (Digital)] or [Present Editing (Film)] button on page 3 of Setting.

The Preset Editing screen of Setting will be displayed.

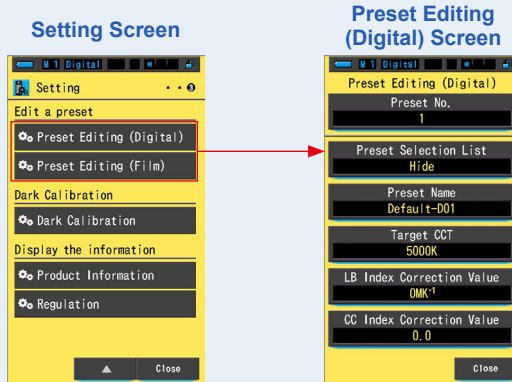

2. Touch the [Preset No.] button.

The preset number is displayed.

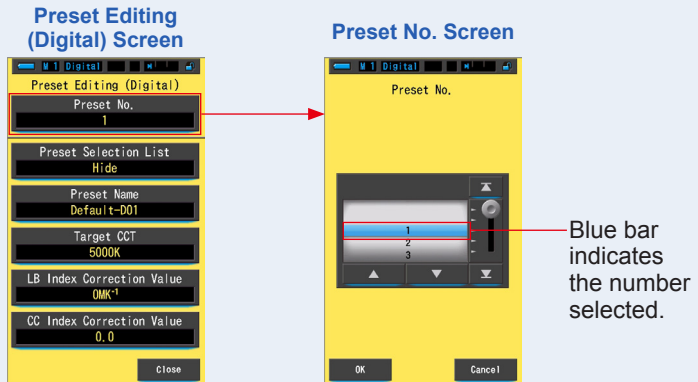

3. Select the desired present number (1 ~ 19) to edit.

Preset No. Screen

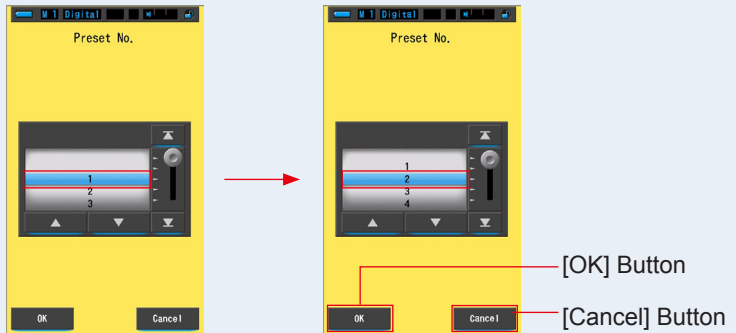

4. Touch the [OK] button.

The number is fixed, and returns to the Preset Editing screen.

The desired preset number to edit is displayed.

To return to the Preset Editing screen without confirming, touch the [Cancel] button.

Preset Editing (Digital) Screen

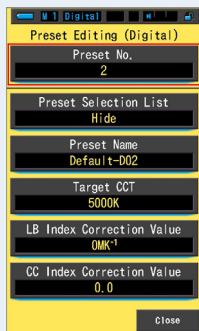

5. Edit each setting item.

Refer to the follow reference pages for editing each setting item.

- Preset Selection List (⇒ P157)
- Preset Name (⇒ P159)
- Target CCT (⇒ P161)
- LB Index Correction Value (⇒ P164)
- CC Index Correction Value (⇒ P166)

6. Touch the [Close] button.

Returns to Setting.

Preset editing is complete.

7-3-1 Displaying the Preset Selection List

Select to display or not in the Preset Selection list in the Tool Box.

Display in the Preset Selection List Screen

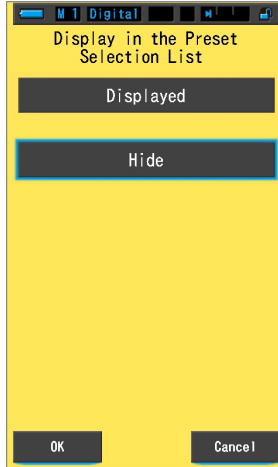

Operation

1. Touch the [Preset Selection List] button.

Display in the Preset Selection List will appear.



2. Select the [Displayed] to set.

The selected icon will be displayed encircled in blue.

Display in the Preset Selection List Screen

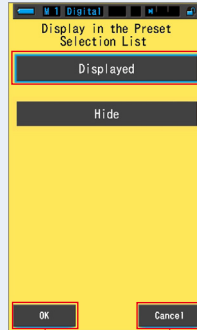
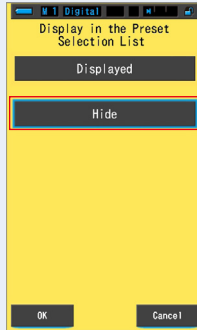

The selected button will be displayed encircled in blue.

[OK] Button

[Cancel] Button

3. Touch the [OK] button.

The set item is fixed, and returns to the Preset Editing screen.

To return to the Preset Editing screen without confirming, touch the [Cancel] button.

Preset Editing (Digital) Screen

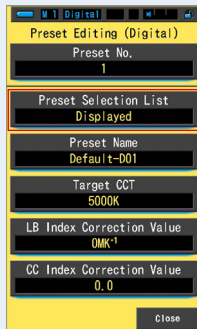

The Preset Selection List is set.

7-3-2 Setting the Present Name

Edit the preset name.



NOTE

Up to 16 alphanumeric characters can be input for Preset name.

Operation

1. Touch the [Preset Name] button.

The Preset Name Input screen is displayed.

Preset Editing (Digital) Screen

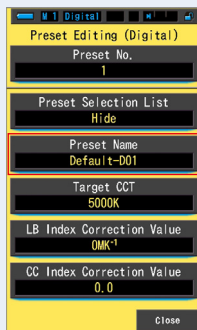

Preset Name Screen

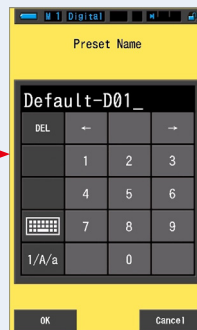

2. Use the keyboard to create a name for preset. (→ P19)

Preset Name Screen

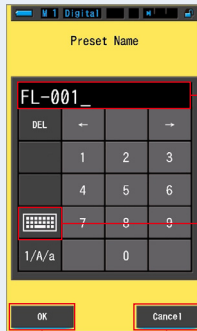

Input number

Keypad (Upper Case Input Screen)



[OK] Button [Cancel] Button

3. Touch the [OK] button.

The Preset name is fixed, and returns to Preset Editing screen.

To return to the Preset Editing screen without confirming (registering/editing), touch the [Cancel] button.

Preset Editing (Digital) Screen

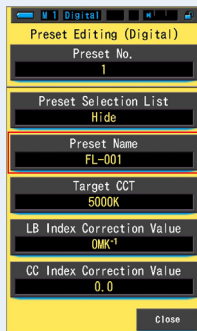

The preset name is set.

7-3-3 Setting the Preset Target Color Temperature

Input the target color temperature for preset.

Reference Color Temperature Screen

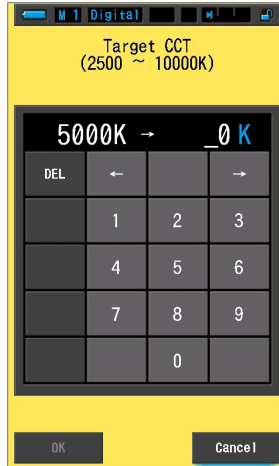

Operation

1. Touch the [Target CCT] button.
The Target CCT screen will be displayed.

Preset Editing (Digital) Screen

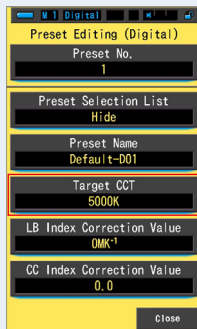

Target CCT Screen

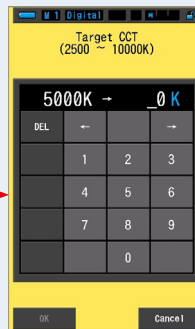

2. Enter the value of the target color temperature. (→ P19)

* The units place is fixed as 0.

Target CCT Screen

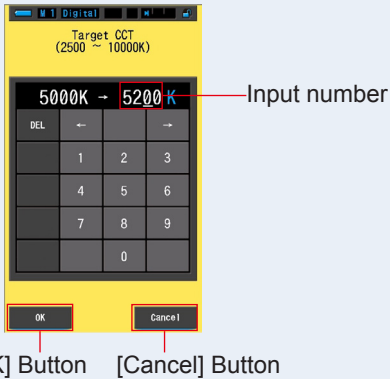

3. Touch the [OK] button.

The number is fixed, and returns to the Preset Editing screen.

To return to the Preset Editing screen without confirming, touch the [Cancel] button.

Preset Editing (Digital) Screen

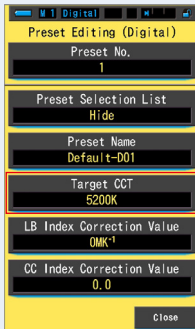

The reference target color temperature is edited.

**NOTE****Digital Mode**

- Set the meter to the same color temperature that was selected in your camera. Please note that many digital cameras reproduce color better at certain color temperature settings. If your work requires optimum color reproduction and high color fidelity, select the camera manufacturers recommended color temperature for best color reproduction. Please refer to your digital camera's operating manual.
- You can set the color temperature from 2,500K to 10,000K.
- When you frequently use several target color temperatures, use preset for convenience.

Film Mode

- Set the target color temperature of the type of film you are using.
 - Daylight Type : 5,500K
 - Tungsten Type-A : 3,400K
 - Tungsten Type-B : 3,200K
- You can set the target color temperature from 2,500K to 10,000K.

7-3-4 Setting the LB Index Correction Value

Sets the preset LB index Correction value.

LB Index Correction Value Screen



Operation

1. Touch the [LB Index Correction Value] button.

The LB index correction value will be displayed.

Preset Editing (Digital) Screen

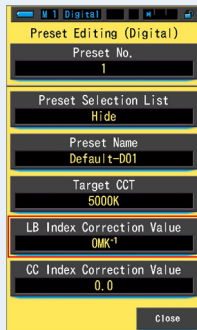

LB Index Correction Value Screen



2. Set the correction value within a range of $\pm 100\text{MK}^{-1}$. (→ P19)

LB Index Correction Value Screen

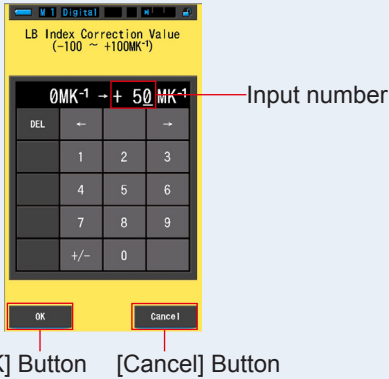

3. Touch the [OK] button.

The number is fixed, and returns to the Preset Editing screen.

To return to the Preset Editing screen without confirming, touch the [Cancel] button.

Preset Editing (Digital) Screen

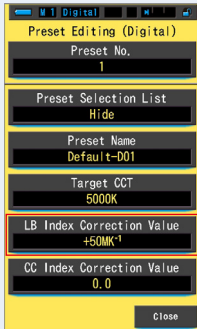

The LB index correction value is edited.

7-3-5

Setting the CC Index Correction Value

Sets the preset CC index Correction value.

CC Index Correction Value Screen

CC Index Correction Value
(40.0G ~ 40.0M)

0.0 →

DEL	←		→
	1	2	3
	4	5	6
	7	8	9
	G/M	0	.

OK Cancel

Operation

1. Touch the [CC Index Correction Value] button.

The CC index correction value will be displayed.

Preset Editing (Digital) Screen

Preset Editing (Digital)

Preset No.
1

Preset Selection List
Hide

Preset Name
Default-D01

Target CCT
5000K

LB Index Correction Value
0MK-1

CC Index Correction Value
0.0

Close

CC Index Correction Value Screen

CC Index Correction Value
(40.0G ~ 40.0M)

0.0 →

DEL	←		→
	1	2	3
	4	5	6
	7	8	9
	G/M	0	.

OK Cancel

2. Set the CC index correction value within a range of 40.0G ~ 40.0M.
(⇒ P19)

CC Index Correction Value Screen

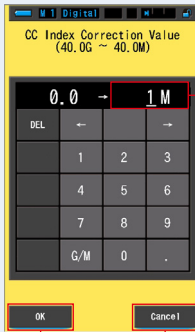

Input number

[OK] Button [Cancel] Button

3. Touch the [OK] button.

The number is fixed, and returns to the Preset Editing screen.

To return to the Preset Editing screen without confirming, touch the [Cancel] button.

Preset Editing (Digital) Screen

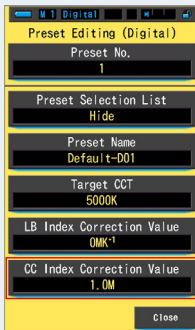

The CC index correction value is edited.



NOTE

Because the CC index correction value unit is an index, 1 of CC index is equivalent to 2.5 CC filter number.

7-4 Dark Calibration



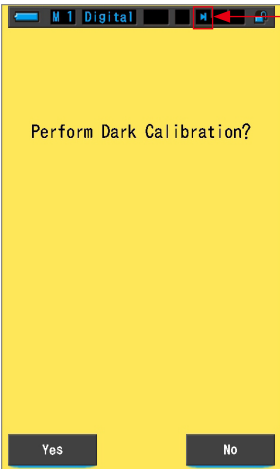

Dark calibration is performed when new batteries are used, 24 hours passed since last use or there is a big change in temperature between turning power OFF and ON again.

Except the cases above, dark calibration after power ON is skipped. Accordingly, when there are sudden changes in temperature experienced while using meter may effect measured values. When temperature changes are encountered, perform dark calibration manually.

Dark Calibration Confirmation Screen



Light Selection Ring Status Indicator Chart

Icon		Content
		If either of icons appears, set the Light Selection Ring ② to the dark calibration position.
		
	CAL	This icon is the dark calibration position. Perform dark calibration after making sure it is set to this position.

Operation

1. Touch the item [Dark Calibration] button on page 3 of Setting.

"Perform Dark Calibration?" will be displayed.

Setting Screen

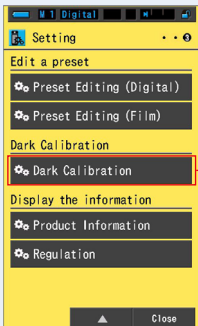

Dark Calibration Confirmation Screen

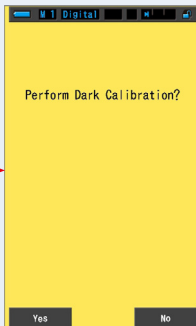

2. Turn the Light Selection Ring ② to set to the dark calibration position CAL ().

The status bar will display the dark calibration icon.

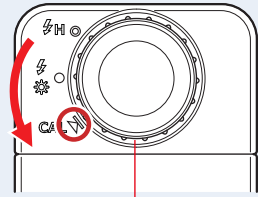
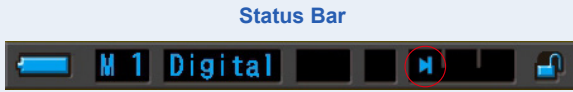

Light Selection Ring ②

3. Touch the [Yes] button.

"Dark calibration in progress. Please wait" and the status bar will appear while calibrating.

To return to Setting without performing dark calibration, touch the [No] button.

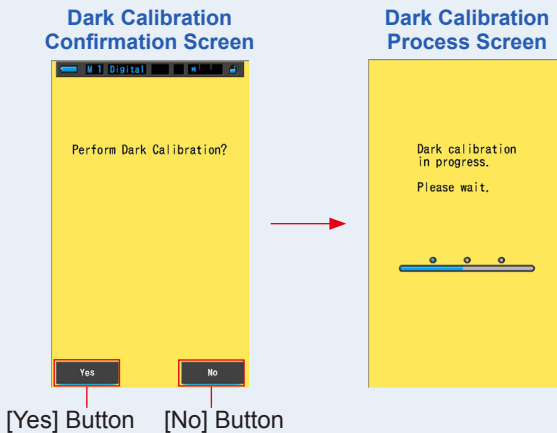

While the message "Dark calibration in progress. Please wait." or the progress bar is displayed, do not turn the power off. Otherwise, the meter may be damaged.

The dark calibration is completed.

When the Following Screen is Displayed

Dark Calibration Position Confirmation Screen



The Light Selection Ring ② is set to Range H (⚡) or Range L (⚡⚙️), and dark calibration could not be performed.

Set the Light Selection Ring ② to the dark calibration position **CAL** (⚡⚙️), and perform dark calibration.

Dark Calibration failure Screen

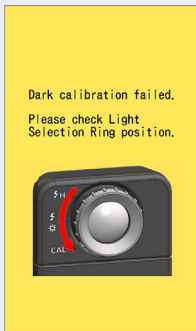

Dark calibration was performed, but it could not be completed normally.

Set the Light Selection Ring ② to the dark calibration position **CAL** (⚡⚙️) again, and perform dark calibration again.

NOTE

- Dark calibration can be done by turning the Light Selection Ring ② to set to the dark calibration position **CAL** (⚡⚙️) in Measuring Screen.
- Dark calibration is performed when new batteries are set, 24 hours passed since last use or there is a big change in temperature between turning power OFF and ON again. Except the cases above, dark calibration after power ON is skipped.

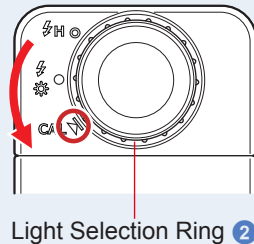

Light Selection Ring ②

7-5 Product Information Display

The Product Information screen displays detailed information not displayed in the Measurement screen.

Product Information Screen

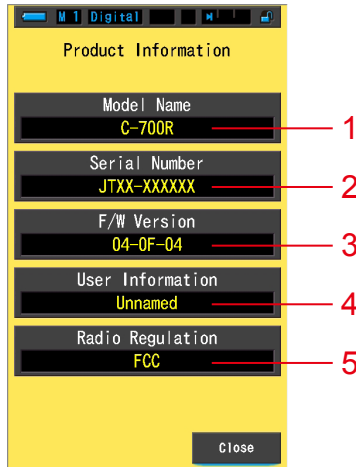

* The screen contents differs depending on model.

No.	Item Name	Description
1	Model Name	Displays the model number of the meter (C-700 or C-700R).
2	Serial Number	Displays the serial number of the meter.
3	F/W Version	Displays the firmware version.
4	User Information	Displays user-input information such as ownership or meter function, etc which is set in the "Hardware Setting". (➡ P174)
5	Radio Regulation	Displays the radio regulations used in Radio Triggering Flash Mode.

Operation

1. Touch the item [Product Information] button on page 3 of Setting.
The Product Information screen will be displayed.

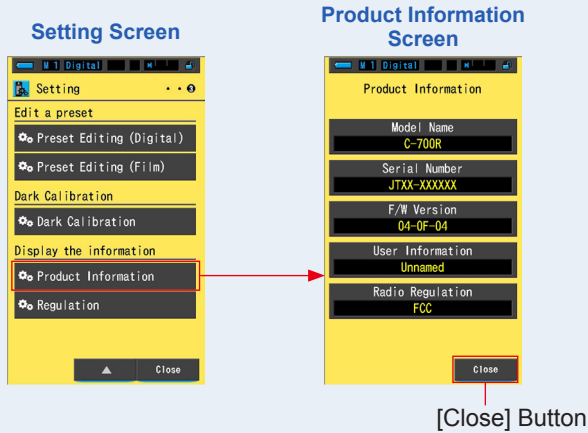

2. Touch the [Close] button.
Returns to Setting.

7-5-1 Regulation Display

The Regulation screen displays the symbols, approved number, regulation names, etc. which the meter is compliance with.

Regulation Screen (for C-700)

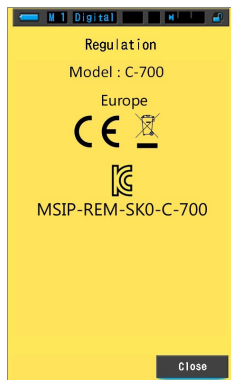

Regulation Screen (for C-700R)

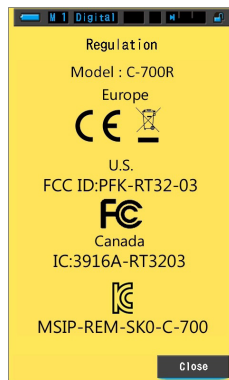

Operation

1. Touch the item [Regulation] button on page 3 of Setting.

The Regulation screen will be displayed.

The display contents will differ depending on the product you have purchased.

Setting Screen



Regulation Screen (for C-700)

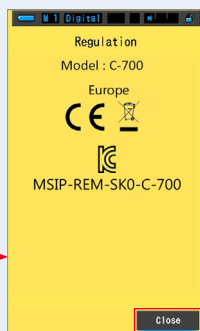

[Close] Button

2. Touch the [Close] button.

Returns to Setting.

8. Hardware Setting Screen

You can set the follow on the Hardware Setting screen.

- Adjust Touch Panel
- Edit User Information
- Factory Setting

Hardware Setting Screen

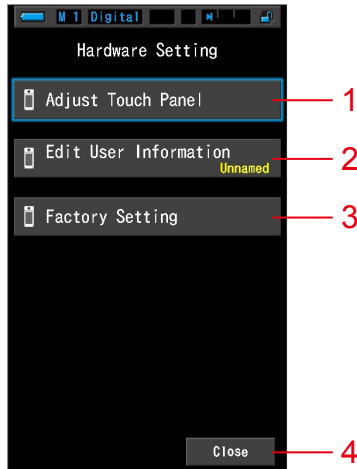

No.	Item Name	Description
1	Adjust Touch Panel	Adjust the position of touch panel display. (➡ P176)
2	Edit User Information	Edit user information to display the User Information screen in Setting. (➡ P179)
3	Factory Setting	Returns all display and setting contents to the factory default. (➡ P181)
4	Close	Closes the Hardware Setting screen and returns to Measuring screen.

Operation

1. While holding the Menu Button ⑥, press the Power Button ③.

* Until the Hardware Setting screen is displayed, do not release the Menu Button ⑥ and the Power Button ③.

If you release the button before the Hardware Setting screen is displayed, the Measurement screen will be displayed.

The Hardware Setting screen is displayed.

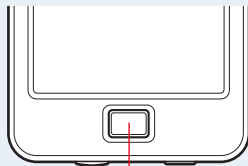

Menu Button ⑥

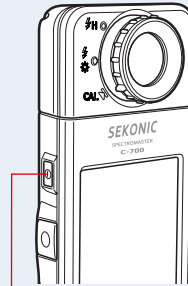

Power Button ③

2. Touch the desired menu item.

The setting screen of the selected item will be displayed.

Refer to the explanations on the following page for each item setting.

3. When finished, touch the [Close] button.

This will return the display to the Measuring screen.

8-1 Adjust Touch Panel

Adjust the position of touch panel display.

Adjust Touch Panel Screen

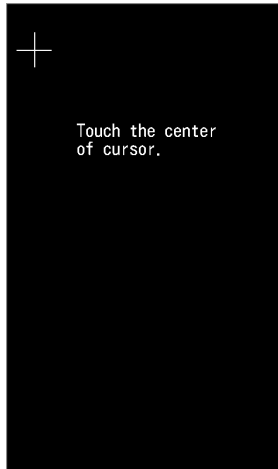

Operation

1. Touch the [Adjust Touch Panel] button on the Hardware Setting screen.

"Touch the center of cursor." will be displayed.

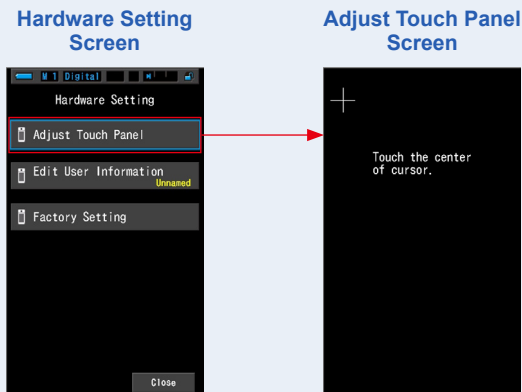

2. Touch the center of the white cross in the upper left corner of the screen.

The touch position will be shown with a red cross cursor, and the white cross cursor will move to the next position.

Adjust Touch Panel Screen

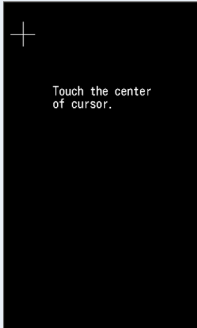

The touch position is showed with a red cross cursor

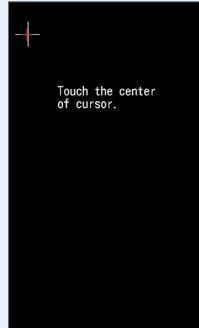

The white cross move to the next position

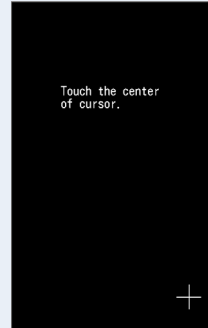

3. Repeat in 7 places.

Continue and repeat in 7 places.

The screen of "Press the "OK" to determine the touch panel adjustment." will be displayed.

Adjust Touch Panel Confirmation Screen

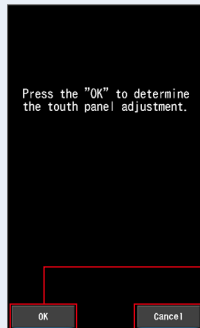

[OK] Button

[Cancel] Button

4. Touch the [OK] button.

Adjustment of touch panel is completed, and returns to the Hardware Setting screen.

To return to the Hardware Setting screen without adjusting the setting, touch the [Cancel] button.

Touch panel adjustment is completed.

 **NOTE**

When a point far from the white cursor is touched, the screen will blink to indicate adjustment failure.
Perform the adjustment again.

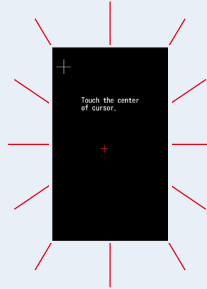
Adjust Touch Panel Screen

8-2 Edit User Information

User information can be input in this screen.

User Information Screen



NOTE

Up to 16 alphanumeric characters can be input.

Operation

1. Touch the [Edit User Information] button on the Hardware Setting screen.

The Edit User Information Input screen is displayed.

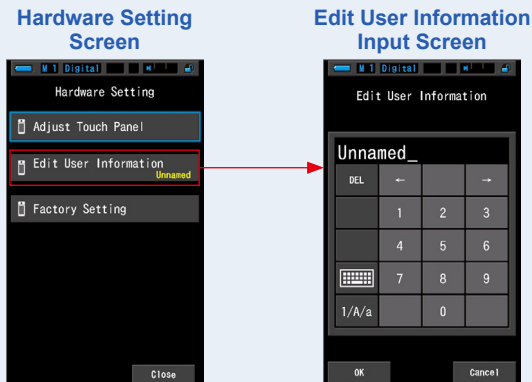

2. Edit the user information. (→ P19)

Edit User Information Input Screen

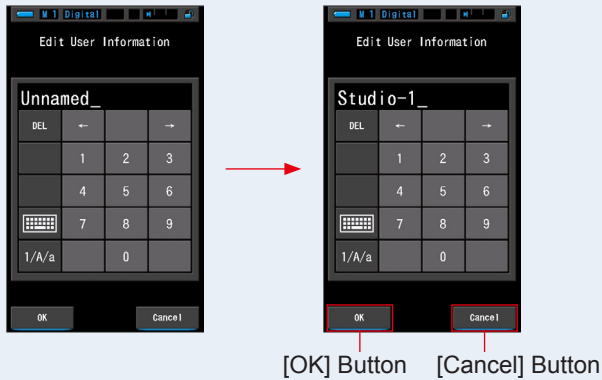

3. Touch the [OK] button.

Registers the user information, and returns to the Hardware Setting screen.

To return to the Hardware Setting screen without registering the user information, touch the [Cancel] button.

Hardware Setting Screen

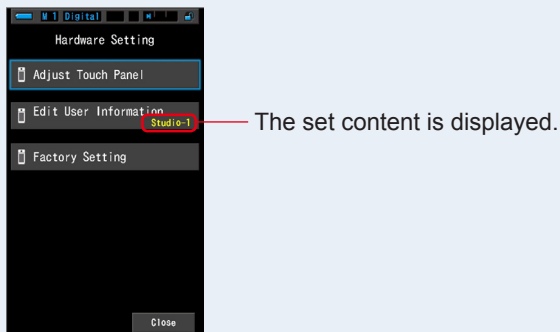

The user information is input.

8-3

Factory Setting

Return all display and setting contents of the meter to the factory default.

Factory Setting Screen



Operation

1. Touch the [Factory Setting] button on the Hardware Setting screen.

The screen of "Reset to factory default settings. Are you sure?" will be displayed.

Hardware Setting Screen

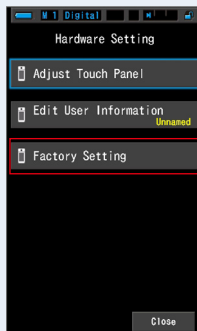

Factory Setting Screen

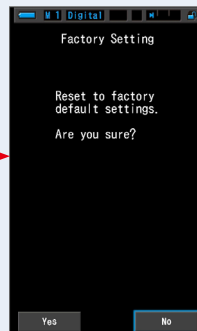

2. Touch the [Yes] button.

The factory setting confirmation message "All measurements will be lost when you perform this operation. Are you sure?" will be displayed.

Confirm again.

To return to the Hardware Setting screen without resetting to factory default settings, touch the [No] button.

Factory Setting Confirmation Screen

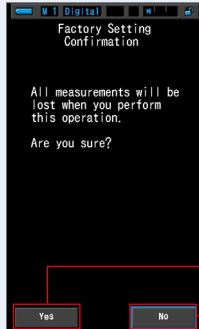

[Yes] Button

[No] Button

3. Touch the [Yes] button.



When the message "Deleting Memory. Please wait." or the progress bar is displayed, do not turn the power off. Otherwise, the meter may be damaged.

All measurement values are deleted, and returns to the Hardware Setting screen. (English display is the default factory setting.)

Factory Setting (Deleting) Screen Hardware Setting Screen

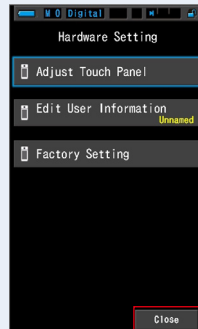

[Close] Button

4. Touch the [Close] button.

The Language Selection screen is displayed. Select the language to use. (→ P5)

Language Selection Screen



Language Selection Confirmation Screen

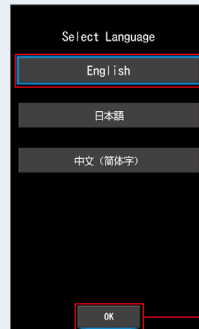

The selected button will be displayed encircled in blue.

[OK] Button

5. Touch the [OK] button.

The Measuring Screen will appear.

Measurement Screen



Factory setting is completed.

9. Appendix

9-1

Glossary

Term	Description
Color Temperature	<p>Color temperature refers to the chromaticity of a heated object (commonly refer to as a black body) that will vary according to its temperature. The color temperature is measured in units of Kelvin (K) and refers to the temperature of a heated object at a given color or chromaticity.</p> <p>The higher color temperature is, the bluer the light, and the larger the Kelvin value becomes. The lower the color temperature is, the redder the light, and the smaller the Kelvin value becomes.</p> <p>A figure that plots the changes of color temperatures on an xy chromaticity diagram is called the black body radiation locus.</p>
Correlated Color Temperature	<p>Not all light sources match the black body radiation locus when measuring light sources.</p> <p>In this case, the correlated color temperature is used. The correlated color temperature is a color temperature obtained by drawing an isothermperature line from the black body radiation locus which matches the measured value.</p>
Photographic Color Temperature	<p>Color temperature calculated by using the ratio of R, G and B characteristics obtained by measurement to match to the characteristic of film.</p>
Light	<p>This refers to the electromagnetic wavelength ranging from 380nm to 780nm that can be detected by the human eye.</p>
Black Body	<p>Theoretically, this is an object that absorbs all wavelengths and when heated, emits light equivalent to the applied color temperature.</p>
Black-body Radiation	<p>This refers to the light emitted by a black body.</p> <p>The amount of energy released for each wavelength changes with the applied color temperature, resulting in visible color variations.</p>
K	<p>Expressed in absolute Kelvin temperature, with units of "K". 0 (zero) K is equivalent to -273.15 °C or -459.67 °F.</p>
Δuv	<p>The deviation between the correlated color temperature and the black body radiation locus.</p> <p>When the correlated color temperature is above the black body radiation locus, a "+" sign is assigned; when below, a "-" sign is assigned.</p>
CRI (Color Rendering Index)	<p>Quantifies the faithfulness of color appearance under a measured light source as compared to the color appearance under a standard light source. Differences are expressed for individual hues, R1-R15, or as an average (Ra) of values R1 through R8.</p>

Term	Description
MK⁻¹	<p>Read as "per mega Kelvin", this unit is based on the International System of Units and is equivalent to the traditional unit of MIRED (mrd). It expresses the inverse of the color temperature. The inverse of the color temperature is 1,000,000 divided by the color temperature.</p> <p>Inverse color temperature = 1,000,000/Color temperature</p> <p>The inverse color temperature decreases as the color temperature increases. Ex.) 10,000K=100MK⁻¹, 3200K=312.5MK⁻¹</p> <p>If a 100K change is applied to both 10,000K and to 3,200K, the human eye perceives the change applied to 3,200K as larger. In other words, there is a difference in perception of the same change in color temperature depending on the color temperature's numerical value.</p> <p>When the inverse color temperature is used, the human eye perceives a given amount of change as the same for any color temperature.</p>
daMK⁻¹	<p>MK⁻¹ divided by 10. Because the unit MK⁻¹ is extremely small compared to the amount of change in color temperature the human eye can perceive, and because performing corrections is difficult, for practical purposes the unit daMK⁻¹ (deca per Mega Kelvin) is used. This unit is also used in conventional filters that change color temperature.</p>
LB Index	<p>The difference of the reciprocal of the selected color temperature and the reciprocal of the measured color temperature. It is expressed in units of MK⁻¹ (equivalent to MIRED) or daMK⁻¹.</p>
LB Filter	<p>Stands for "Light Balancing Filter", and refers to a filter used for correcting color temperature in photography. A blue filter is used to raise the light source color temperature, while an amber filter is used to lower it.</p> <p>By using the custom settings in the C-700/C-700R, the display can be changed to show the type of the filter brand being used.</p>
CC Index	<p>Number that expresses the amount of difference between the G component (Green range) of the measured light source and the base black body radiation of the color temperature. 1CC index is equivalent to 2.5CC filter number.</p>
CC Filter Number	<p>Stands for "Color Compensating Filter", and refers to a filter used for correcting color in lighting.</p> <p>There are 6 different types of filters Yellow (Y), Magenta (M), Cyan (C), Blue (B), Green (G), and Red (R), but the C-700/C700R only uses the Magenta (M) and Green (G) types.</p>

9-2 Filter Types

When using camera LB/CC filters based on the recommended compensation displayed in the meter (C-700 series), please note that camera lens filters block or absorb light to produce their effect and thus the amount of light passing through them for exposure will be reduced.

If your camera does not have a through the lens exposure system and you are using a handheld exposure meter to determine camera settings, consult the table below to find how much to increase the exposure to compensate for the light absorbed by the lens filter.

When you use a lighting filter, exposure compensation is not necessary, because the intensity of the light is already decreased.

■ Kodak WRATTEN 2/LEE Filter [Camera Filter]

Amber Type			Blue Type		
LB Index (MK ⁻¹)	Filter Number	Exposure Increase Increment (+EV)	LB Index (MK ⁻¹)	Filter Number	Exposure Increase Increment (+EV)
+9	81	1/3	-10	82	1/3
+18	81A	1/3	-21	82A	1/3
+27	81B	1/3	-32	82B	2/3
+35	81C	1/3	-45	82C	2/3
+42	81D	2/3	-56	80D	2/3
+52	81EF	2/3	-81	80C	1
+81	85C	1/3	-112	80B	1 2/3
+112	85	2/3	-131	80A	2
+131	85B	2/3			

Magenta Type			Green Type		
CC index	Filter Number	Exposure Increase Increment (+EV)	CC index	Filter Number	Exposure Increase Increment (+EV)
+1.0	CC025M	0	-1.0	CC025G	0
+2.0	CC05M	1/3	-2.0	CC05G	1/3
+4.0	CC10M	1/3	-4.0	CC10G	1/3
+8.0	CC20M	1/3	-8.0	CC20G	1/3
+12.0	CC30M	2/3	-12.0	CC30G	2/3
+16.0	CC40M	2/3	-16.0	CC40G	2/3
+20.0	CC50M	1	-20.0	CC50G	2/3

■ FUJIFILM Filter [Camera Filter]

Amber Type			Blue Type		
LB Index (MK ⁻¹)	Filter Number	Exposure Increase Increment (+EV)	LB Index (MK ⁻¹)	Filter Number	Exposure Increase Increment (+EV)
+10	LBA-1	0	-10	LBB-1	0
+20	LBA-2	1/3	-20	LBB-2	1/3
+30	LBA-3	1/3	-30	LBB-3	1/2
+40	LBA-4	1/3	-40	LBB-4	2/3
+60	LBA-6	2/3	-60	LBB-6	2/3
+80	LBA-8	2/3	-80	LBB-8	1
+120	LBA-12	2/3	-120	LBB-12	1 2/3
+160	LBA-16	1	-160	LBB-16	2
+200	LBA-20	1	-200	LBB-20	2 1/3

Magenta Type			Green Type		
CC index	Filter Number	Exposure Increase Increment (+EV)	CC index	Filter Number	Exposure Increase Increment (+EV)
+0.5	CC-1.25M	0	-0.5	CC-1.25G	0
+1.0	CC-2.5M	0	-1.0	CC-2.5G	0
+2.0	CC-5M	1/3	-2.0	CC-5G	1/4
+3.0	CC-7.5M	1/3	-3.0	CC-7.5G	1/3
+4.0	CC-10M	1/2	-4.0	CC-10G	1/3
+8.0	CC-20M	2/3	-8.0	CC-20G	1/2
+12.0	CC-30M	2/3	-12.0	CC-30G	2/3
+16.0	CC-40M	1	-16.0	CC-40G	2/3
+20.0	CC-50M	1 1/3	-20.0	CC-50G	1

■ LEE [Lighting Filter]

LB index (MK ⁻¹)	Filter No.	Filter Name	CCT(K) Conversion
-18	L218	1/8 CTB	3200 to 3400
-35	L203	1/4 CTB	3200 to 3600
-78	L202	1/2 CTB	3200 to 4300
-113	L281	3/4 CTB	3200 to 5000
-137	L201	FULL CTB	3200 to 5700
-200	L283	ONE AND 1/2 CTB (1.5 CTB)	3200 to 8888
-274	L200	DOUBLE CTB	3200 to 26000
+26	L223	1/8 CTO	6500 to 5550
+64	L206	1/4 CTO	6500 to 4600
+109	L205	1/2 CTO	6500 to 3800
+124	L285	3/4 CTO	6500 to 3600
+159	L204	FULL CTO	6500 to 3200
+245	L286	ONE AND 1/2 CTO (1.5 CTO)	6500 to 2507
+312	L287	DOUBLE CTO	6500 to 2147

CC index	Filter No.	Filter Name	CC Filter Equivalent
-1.4	L278	1/8 PLUS GREEN (1/8 PLUS G)	CC 035 Green
-3.0	L246	1/4 PLUS GREEN (1/4 PLUS G)	CC 075 Green
-6.0	L245	1/2 PLUS GREEN (1/2 PLUS G)	CC 15 Green
-12.0	L244	FULL PLUS GREEN (PLUS GREEN)	CC 30 Green
+1.4	L279	1/8 MINUS GREEN	CC 035 Magenta
+3.0	L249	1/4 MINUS GREEN	CC 075 Magenta
+6.0	L248	1/2 MINUS GREEN	CC 15 Magenta
+12.0	L247	FULL MINUS GREEN	CC 30 Magenta

() Displayed in C-700/C-700R

■ ROSCO CINEGEL [Lighting Filter]

LB index (MK ⁻¹)	Filter No.	Filter Name	CCT(K) Conversion
-12	R3216	1/8 CTB	3200 to 3300
-30	R3208	1/4 CTB	3200 to 3500
-49	R3206	1/3 CTB	3200 to 3800
-68	R3204	1/2 CTB	3200 to 4100
-100	R3203	3/4 CTB	3200 to 4700
-131	R3202	FULL CTB	3200 to 5500
-260	R3220	DOUBLE CTB	2800 to 10000
+20	R3410	1/8 CTO	5500 to 4900
+42	R3409	1/4 CTO	5500 to 4500
+81	R3408	1/2 CTO	5500 to 3800
+131	R3411	3/4 CTO	5500 to 3200
+167	R3407	FULL CTO	5500 to 2900
+320	R3420	DOUBLE CTO	10000 to 2400

CC index	Filter No.	Filter Name	CC Filter Equivalent
-1.4	R3317	1/8 PLUS GREEN (1/8 PLUS G)	CC 035 Green
-3.0	R3316	1/4 PLUS GREEN (1/4 PLUS G)	CC 075 Green
-6.0	R3315	1/2 PLUS GREEN (1/2 PLUS G)	CC 15 Green
-12.0	R3304	PLUS GREEN	CC 30 Green
+1.4	R3318	1/8 MINUS GREEN (1/8 MINUS G)	CC 035 Magenta
+3.0	R3314	1/4 MINUS GREEN (1/4 MINUS G)	CC 075 Magenta
+6.0	R3313	1/2 MINUS GREEN (1/2 MINUS G)	CC 15 Magenta
+9.0	R3309	3/4 MINUS GREEN (3/4 MINUS G)	CC 22.5 Magenta
+12.0	R3308	MINUS GREEN	CC 30 Magenta

() Displayed in C-700/C-700R

■ ROSCO E-COLOUR+ [Lighting Filter]

LB index (MK ⁻¹)	Filter No.	Filter Name	CCT(K) Conversion
-18	E218	1/8 CTB	3200 to 3400
-35	E203	1/4 CTB	3200 to 3600
-78	E202	1/2 CTB	3200 to 4300
-113	E281	3/4 CTB	3200 to 5000
-137	E201	FULL CTB	3200 to 5700
-200	E283	ONE AND 1/2 CTB (1.5 CTB)	3200 to 8900
-274	E200	DOUBLE CTB	2800 to 10000
+26	E223	1/8 CTO	Daylight to 5300
+64	E206	1/4 CTO	Daylight to 4600
+109	E205	1/2 CTO	Daylight to 3800
+124	E285	3/4 CTO	Daylight to 3500
+159	E204	FULL CTO	Daylight to 3200
+245	E286	ONE AND 1/2 CTO (1.5 CTO)	Daylight to 2507
+312	E287	DOUBLE CTO	Daylight to 2120

CC index	Filter No.	Filter Name	CC Filter Equivalent
-1.4	E278	1/8 PLUS GREEN	CC 035 Green
-3.0	E246	1/4 PLUS GREEN	CC 075 Green
-6.0	E245	1/2 PLUS GREEN	CC 15 Green
-12.0	E244	FULL PLUS GREEN	CC 30 Green
+1.4	E279	1/8 MINUS GREEN	CC 035 Magenta
+3.0	E249	1/4 MINUS GREEN	CC 075 Magenta
+6.0	E248	1/2 MINUS GREEN	CC 15 Magenta
+12.0	E247	FULL MINUS GREEN	CC 30 Magenta

() Displayed in C-700/C-700R

- * Kodak and Wratten are trademarks of Eastman Kodak Company.
- * Fujifilm is a registered trademark of Fujifilm Corporation.
- * LEE is a registered trade mark of Lee Filters, a division of Panavision Europe Ltd.
- * Rosco, Cinegel, and E-Colour+ are a registered trademarks of Rosco Laboratories Inc.
- * All other company or product names are trademarks or registered trademarks of the respective companies.

9-3

Specifications

Type

- Spectrometer with CMOS linear image sensor for digital or film cameras

Illuminance meter class

- Conforms to JIS C 1609-1:2006 for General Class A Illuminance Meters

Light receiving method

- Incident light

Light receptor

- White diffuser (fixed type)

Light receptor element

- CMOS linear image sensor 128 pixels

Measurement system

• Measuring mode	• Ambient light	Ambient light mode
	• Flash light	Cord flash mode with sync cord Cordless flash mode Radio triggering flash mode (C-700R Only)
• Measurement type	• Digital	Color temperature measurement based on color matching function (Correlated color temperature)
	• Film	Color temperature measurement based on approximation of film spectral characteristics (Photographic color temperature)
	• Illuminance	Complies with JIS C1609-1:2006 general A class illuminometer
• Display mode	• Digital/Film	Text mode, Spectrum mode Spectrum Comp. mode, CRI mode Camera Filter mode, Lighting Filter mode Multi Lights mode, WB Corr. mode
	• Illuminance/ luminous exposure	lux (lx), lx per second (lx·s) foot-candle (fc), foot-candle per second (fc·s) (in limited version only)

Measurement range

• Illuminance in color temperature measurement	Ambient light	5lx ~ 200,000lx 0.46FC ~ 18,600FC (in limited version only)
• Illuminance	• Ambient light	1lx to 200,000lx 0.1fc to 18,600fc (in limited version only)
	• Flash light	Range L: 20lx·s ~ 640lx·s (f/2.8 to f/16) Range H: 580lx·s ~ 20,500lx·s (f/16 to f/90)

Accuracy

• Illuminance	±5% ±1digit of indicated value (Complies with JIS C1609-1:2006 general A class illuminometer)
• Color temperature	±4MK ⁻¹ (Light source A, 800lx)

Repeatability (2σ)

• Illuminance	1% + 1digit (Light source A, 30lx ~ 200,00lx), 5% + 1digit (Light source A, 1lx ~ 30lx)
• Color temperature	• Light source A, 500lx ~ 100,000lx 2MK ⁻¹ • Light source A, 100lx ~ 500lx 4MK ⁻¹ • Light source A, 30lx ~ 100lx 8MK ⁻¹ • Light source A, 5lx ~ 30lx 17MK ⁻¹

Spectral response characteristics

• f1'	9% or less (Complies with JIS C1609-1:2006 general A class illuminometer)
-------	---

Oblique incident light characteristics

• f2	6% or less (Complies with JIS C1609-1:2006 general A class illuminometer)
------	---

Temperature characteristics

• Illuminance	±5% of indicated value (Complies with JIS C1609-1:2006 general A class illuminometer)
• Color temperature	12MK ⁻¹ (Light source A, 1000lx)

Humidity characteristics

• Illuminance	±3% of indicated value (Complies with JIS C1609-1:2006 general A class illuminometer)
• Color temperature	±12MK ⁻¹ (Light source A, 1000lx)

Display range

• Correlated color temperature	• Digital	1,600K ~ 40,000K (3 significant digits)
• Photographic color temperature	• Film	1,600K ~ 40,000K (3 significant digits)
• Target color temperature settings		2,500K ~ 10,000K
• LB Index	• 1MK ⁻¹ step	-500MK ⁻¹ ~ +500MK ⁻¹
	• 1daMK ⁻¹ step	Without decimal point: -50daMK ⁻¹ ~ +50daMK ⁻¹
	• 0.1daMK ⁻¹ step	With decimal point: -50.0daMK ⁻¹ ~ +50.0daMK ⁻¹
• CC index	• 80G ~ 80M	
• Illuminance	• Ambient light	1lx ~ 200,000lx (3 significant digits) 0.1fc ~ 18,600fc (3 significant digits) (in limited version only)
• Shutter speed	• Flash light	1 second ~ 1/500 second (in 1, 1/2, 1/3 step) plus: 1/75, 1/80, 1/90, 1/100, 1/200, 1/400 second

Other functions

- Preset setting
- Setting
- Memory function
- Memory clear/recall function
- Out of measurement range or out of display range
- Battery capacity indicator display
- Automatic power OFF function
- LCD backlight
- Touch panel lock function
- Tripod socket
- Preset 1 ~ 19 settings for each digital or film mode
- 11 item settings (C-700R: 12 item settings possible)
- Up to 99 measurements or titles
- [Under]/[Over]/[Filter N/A] warning display
- With 4 level status icons
- Time elapsed after last operation: selectable from 20min., 10min., 5min., none
- Brightness can be selected from bright, normal, or dark
- Dimmer time after last operation: selectable from about 20second, about 40second, about 60second, none
- 1/4-inch, 20 threads

Used radio frequency

- Standard System
 - FCC&IC (CH1 to 16) 344.04MHz
(CH17 to 32) 346.5 ~ 354.0MHz
 - CE (CH1 to 16) 433.62MHz
(CH17 to 32) 434.22MHz
- ControlTL® System
 - FCC&IC (CH1 to 4) 344 to 346.0MHz
(CH5 to 20) 341.5 to 351.0MHz
 - CE (CH1 to 3) 433.42 ~ 434.42MHz

Display

- LCD display resolution • 4.3 inch QVGA 480×800 dots

Recommended battery

- AA batteries • 1.5V × 2 alkaline, manganese
- USB bus-power • 5V/500mA or less (via USB cable when connected to computer)

Operating temperature

- -10°C ~ 40°C (without condensation)

Operating humidity

- 85%RH or less (at 35°C) (without condensation)

Transportation and storage conditions

- -10°C ~ 60°C (without condensation)

Dimensions

- Approx. 73 (width) × 183 (height) × 27 (depth) mm
(excluding protruding part of light receiving) (max. thickness 40mm)

Weight

- (C-700) approx. 230g (without batteries)
- (C-700R) approx. 238g (without batteries)

Included accessories

- CD-ROM (this Operating Manual and applications (Win & Mac)), Soft case, Strap, Start-up Guide, Safety Precaution



* Specifications and appearance described in this Operating Manual are subject to change without prior notice for improvements.

9-4

Legal Requirement

■ Legal Requirement

This product complies with the following legal requirements.

Destination	Standard		Details
Europe	CE 	SAFETY	EN 60950-1:2006 + A11:2009 + A1:2010 + A12:2011 + A2:2013
		EMC	EMS: EN55024:2010 EMI: EN55022:2010
		Wireless	R&TTE Directive 1999/5/EC EN300 220-2 V2.4.1 (2012-05) EN301 489-1 V1.9.2 (2011-09) EN301 489-3 V1.6.1 (2013-08) EN62479:2010
		Environmental	WEEE, RoHS, REACH
North America	FCC (US) 	EMC	FCC Part15 SubpartB ClassB
		Wireless	FCC Part15 SubpartC
	IC (Canada)	EMC	ICES-003
		Wireless	RSS-210 Issue8
Japan		Environmental	Containers and Packaging Recycling Law
China		Environmental	China RoHS (GB 189455)
South Korea	KC	EMC	KN11, KN61000-4-2/-3/-4/-6/-8
		1. 기자재의명칭 (모델명) : COLOR METER (C-700) 2. 식별부호 : MSIP-REM-SK0-C-700 3. 상호명 : SEKONIC CORPORATION 4. 제조자 : SEKONIC CORPORATION 5. 제조국가 : 일본	

10. Optional Accessories

■ Synchro Cord

A convenient five-meter (=16.4 feet) long cord with three plugs, allowing you to connect and synchronize between a color meter, flash unit and camera, so there is no need to plug or unplug the cord during a shooting. Also, one terminal of the sync cord has a locking mechanism to ensure connection when used with a color meter.

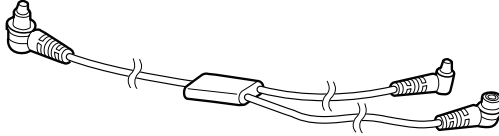

11. Troubleshooting

The following cases may not suggest failures. Please check again before requesting repair. When the meter does not function normally after checking the following, it may be damaged. Remove the battery, and ask the retailer or us to repair it.

Status	Check item	Measure
It does not turn on (It does not display)	Are you pressing and holding the Power Button for one or more seconds?	Press and hold the Power Button for one or more seconds.
	Are ⊕ ⊖ of the batteries inserted properly?	Check the ⊕ ⊖ signs. (➔ P4)
	Is there enough battery?	Replace the battery. (➔ P9)
	Are the battery terminals dirty?	Wipe them off with a dry cloth.
	Are you using the specified batteries?	Check the batteries. (➔ P4)
The LCD does not respond	Is the screen locked?	Press and hold the Menu Button 6 to unlock the screen. (➔ P21)
The measurement cannot be made	Are you using the "C-700 Series Utility"?	Stop using the "C-700 Series Utility".
The measured values are wrong	Is the Light Selection Ring in the middle position? The light distribution characteristics change and suitable measurements cannot be made.	Rotate the Light Selection Ring until it clicks.
	Are any unnecessary corrections or filter corrections set?	Check the Target (reference color temperature) to see if the setting is wrong. (➔ P26)
		Check the Preset Target Color Temperature and confirm the setting is correct. (➔ P161)
	Is the measuring mode wrong? (Such as measuring in Ambient Light Mode in flash light)	Check if the measuring mode is correct. (➔ P22)
Are you using the pre-flash function when measuring in Cordless Flash Mode?	In Cordless Flash Mode, the measurement value of the main flash may not be displayed because the pre-flash is measured at first. Cancel the pre-flash function.	

Status	Check item	Measure
Setting values and measurement values of the spectrometer are not in the camera settings	Do the shutter speed and iris setting step of the camera and the shutter speed and iris setting step of the spectrometer match?	Some cameras can select 1/3 step, 1 step and 1/2 step, like a spectrometer. Match the step of the spectrometer with the step of the camera. (Shutter Speed Step) (▶ P127)
The memory function cannot be used	Is the differential measurement icon displayed?	The memory function cannot be used when the differential measurement icon is displayed. Cancel the differential measurement mode.
	Is "Memory Full" displayed when pressing the Memory Button?	The memory can store up to 99 values. Clear unnecessary memory values in advance, measure, and memorize it.
Flash cannot be triggered in Radio Triggering Flash Mode. (C-700R only)	Do you use a receiver that installs the PocketWizard® system? Or do you use a radio system of other brands or manufacturers?	Use a receiver that installs the PocketWizard® system. www.pocketwizard.com
	Do the radio destination of the spectrometer that is a transmitter and the receiver match?	There are two types, FCC&IC (344 MHz band) and CE (433 MHz band). Check if the destinations (frequency) of the transmitter and the receiver are the same.
	Did you set the same channel number to the transmitter and the receiver? Are you mixing the Standard system and the ControlTL® system?	Check if the transmitter and the receiver use the same system, either the Standard system or the ControlTL® system, and set the same channel number.

SEKONIC CORPORATION

7-24-14, Oizumi-Gakuen-Cho, Nerima-Ku, Tokyo
178-8686 Japan

Tel +81-3-3978-2335 Fax +81-3-3978-5229

<http://www.sekonic.com>

JT109761-B_en-02
JULY 2015