

## AD2 -- Handheld Transmitter

---

### WARNING

- Battery packs may explode or release toxic materials. Risk of fire or burns. Do not open, crush, modify, disassemble, heat above 140°F (60°C), or incinerate.
- Follow instructions from manufacturer
- Only use Shure charger to recharge Shure rechargeable batteries
- **WARNING:** Danger of explosion if battery incorrectly replaced. Replace only with same or equivalent type.
- Never put batteries in mouth. If swallowed, contact your physician or local poison control center
- Do not short circuit; may cause burns or catch fire
- Do not charge or use battery packs other than Shure rechargeable batteries
- Dispose of battery packs properly. Check with local vendor for proper disposal of used battery packs.
- Batteries (battery pack or batteries installed) shall not be exposed to excessive heat such as sunshine, fire or the like

**Note:** Use only with the included power supply or a Shure-approved equivalent.

**WARNING:** Danger of explosion if incorrect battery replaced. Operate only with AA batteries.

Please follow your regional recycling scheme for batteries, packaging, and electronic waste.

**WARNING:** This product contains a chemical known to the State of California to cause cancer and birth defects or other reproductive harm.

低功率電波輻射性電機管理辦法

第十二條

經型式認證合格之低功率射頻電機，非經許可，公司、商號或使用者均不得擅自變更頻率、加大功率或變更原設計之特性及功能。第十四條

低功率射頻電機之使用不得影響飛航安全及干擾合法通信；經發現有干擾現象時，應立即停用，並改善至無干擾時方得繼續使用。前項合法通信，指依電信法規定作業之無線電通信。低功率射頻電機須忍受合法通信或工業、科學及醫療用電波輻射性電機設備之干擾。

---

## AD2 Handheld Transmitter

AD series hand-held transmitters deliver impeccable audio quality and RF performance with wide-tuning, High Density (HD) mode, and encryption. The transmitter features durable metal construction, AA or SB900A rechargeable power (with dockable charging), and black or nickel finish options.

# Features

## Performance

- 20 Hz to 20 kHz range with flat frequency response
- Automatic input staging optimizes gain setting
- AES 256-bit encryption-enabled for secure transmission
- >120 dB dynamic range
- 100 meter (300 feet) line-of-sight operating range
- Selectable modulation modes optimize performance for spectral efficiency or audio quality:
  - Standard – optimal coverage, low latency
  - High density – dramatic increase in max system channel count
- Switchable Power Levels = 2/10/35 mW (region dependent)
- Built-in tone generator and RF markers to facilitate range-testing

## Design

- Interchangeable Shure microphone cartridges
- Backlit LCD with easy to navigate menu and controls
- Rugged metal construction
- Menu and power lockout

## Power

- Up to 8 hours continuous use with 2 x AA alkaline batteries
- Shure SB900A lithium-ion rechargeable battery provides extended battery life, precision metering, and zero memory effect
- External charging contacts for docked charging

## Included Components

Zipper Bag	95B2313
Euro-Threaded Adapter	31B1856
Swivel Adapter, black	90F4046
AA Alkaline Battery (2)	80B8201
Battery Contact Cover	WA618

Choice of (1) of the following Shure microphone cartridges:

<b>SM58</b> (RPW112)	<b>KSM9 Nickel</b> (RPW188)
<b>BETA 87C</b> (RPW122)	<b>BETA 87A</b> (RPW120)
<b>BETA 58A</b> (RPW 118)	<b>KSM9 Black</b> (RPW184)
<b>KSM8 Black</b> (RPW174)	<b>KSM8 Nickel</b> (RPW170)
<b>KSM9HS Black</b> (RPW186)	<b>KSM9HS Nickel</b> (RPW190)

## Optional Accessories

SB900A Rechargeable lithium-ion battery	SB900A
Radome Color ID Kit for AD2	WA617M
Microphone stand adapter	WA371

Optional Shure microphone cartridges:

**SM58** (RPW112)

**SM86** (RPW114)

**SM87A** (RPW116)

**BETA 58A** (RPW118)

**BETA 87A** (RPW120)

**BETA 87C** (RPW122)

**VP68** (RPW124)

**KSM9 Nickel** (RPW188)

**KSM9HS Nickel** (RPW190)

**KSM9 Black** (RPW184)

**KSM9HS Black** (RPW186)

## AD2 Transmitter Overview

### ① Microphone Cartridge

See Optional Accessories for a list of compatible cartridges.

### ② Display

View menu screens and settings. Press any control button to activate the backlight.

### ③ Infrared (IR) Port

Align with the receiver IR port during an IR Sync for automated transmitter programming.

### ④ Menu Navigation Buttons

Use to navigate through parameter menus and change values.

### ⑤ Battery Compartment

Requires Shure SB900A rechargeable battery or 2 AA batteries.

### ⑥ AA Battery Adapter

Remove to accommodate a Shure SB900A battery.

### ⑦ On/Off Switch

Powers the unit on or off.

### ⑧ Battery Door

Latch to secure batteries.

### ⑨ Handle

Unscrew to access controls and batteries.

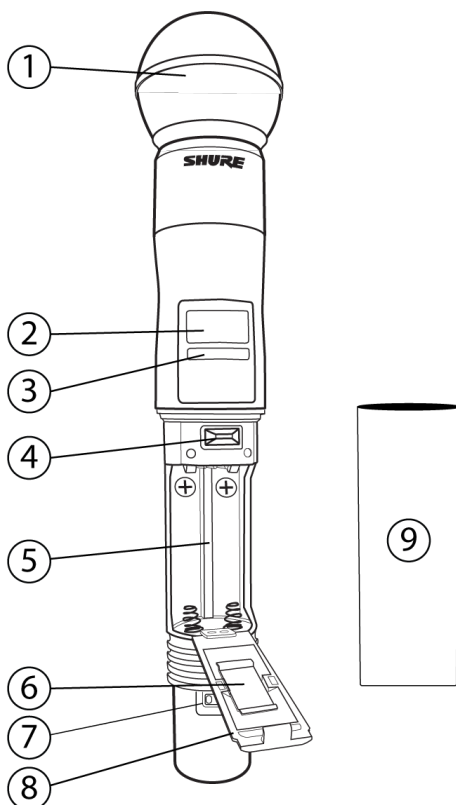

## Transmitter Controls

Use to navigate through parameter menus and change values.

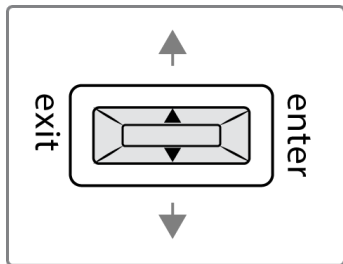

exit	Acts as a 'back' button to return to previous menus or parameters without confirming a value change
enter	Enters menu screens and confirms parameter changes
∨∧	Use to scroll through menu screens and to change parameter values

Tip: Use the following control shortcuts for quick set up:

- Hold the ∨ button while powering-on to lock or unlock the transmitter controls
- Hold the exit button while powering-on to set the transmitter RF output to mute

## Home Screen Display



The home screen shows transmitter information and status.

Tip: There are four options to choose the information shown on the home screen. Use the arrow buttons to select one of the following choices:

<ul style="list-style-type: none"> <li>• Name</li> <li>• Frequency Setting</li> <li>• Group (G) and Channel (C)</li> <li>• Device ID</li> </ul>	A screenshot of a transmitter's home screen. It features the "Shure" logo at the top left, a key icon with a lock symbol at the top right, the frequency "470.200MHz" in the center, and the time "7:45" in a box at the bottom.
---	--

The following icons appear to indicate transmitter settings:

	Battery runtime in hours and minutes or bar display
	Key: Displayed when encryption is enabled

	Lock: Displayed when controls are locked. Icon will flash if access is attempted to a locked control (power or menu).
STD	STD: Standard Transmission Mode
HD	HD: High Density Transmission Mode
	Box: When the box has an "X", Mute Mode is on and engaged. If the box is empty, Mute Mode is on, but not engaged.

## Locking the Interface

Lock transmitter interface controls to prevent accidental or unauthorized changes to parameters. The lock icon appears on the home screen when the interface lock is enabled.

- From the Utilities menu, navigate to Locks and select one of the following lock options:
  - None: The controls are unlocked
  - Power: The power switch is locked
  - Menu: The menu parameters are locked
  - All: The power switch and menu parameters are locked
- Press enter to save.

Tip: To quickly unlock a transmitter: Press enter twice, select None, and press enter.

## Battery Installation

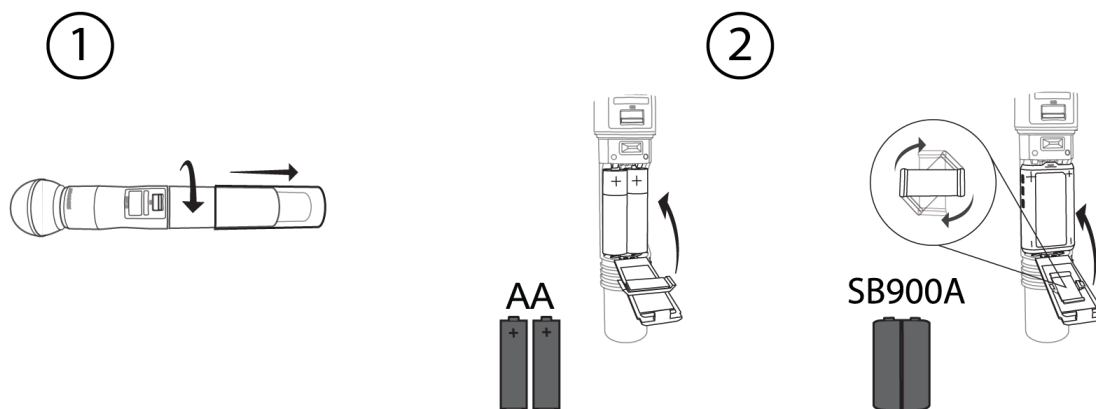

① Accessing the Battery Compartment	Unscrew the cover on the transmitter as shown to access the battery compartment.
-------------------------------------	--

## ② Installing Batteries

- **AA Batteries:** Place batteries (note polarity markings) and AA Adapter as shown. Close the door to secure the batteries.
- **Shure SB900A Battery:** Place battery as shown (note polarity markings). Remove the AA adapter and stow it in the door. Close the door to secure the battery.

**Note:** If using AA batteries, set the battery type using the transmitter menu.

## Setting the AA Battery Type

To ensure accurate display of transmitter runtime, set the battery type in the transmitter menu to match the installed AA battery type.

Note: If a Shure SB900A rechargeable battery is installed, selecting a battery type is not necessary and the battery type will display Shure.

1. Navigate to the Utilities and select Battery.
2. Use the ▼ ▲ buttons to select the installed battery type:
  - Alkaline = Alkaline
  - NiMH = Nickel Metal Hydride
  - Lithium = Lithium Primary
3. Press enter to save.

Battery  
Battery: Alkaline

Battery  
Battery: NiMH

Battery  
Battery: Lithium

## Installing the Battery Contact Cover

Use battery contact covers to prevent reflections from the battery contacts during broadcasts or live performances.

1. Remove the transmitter handle.
2. Pull gently on the antenna cover to remove. Install a battery contact cover in its place.
3. Reinstall the transmitter handle.

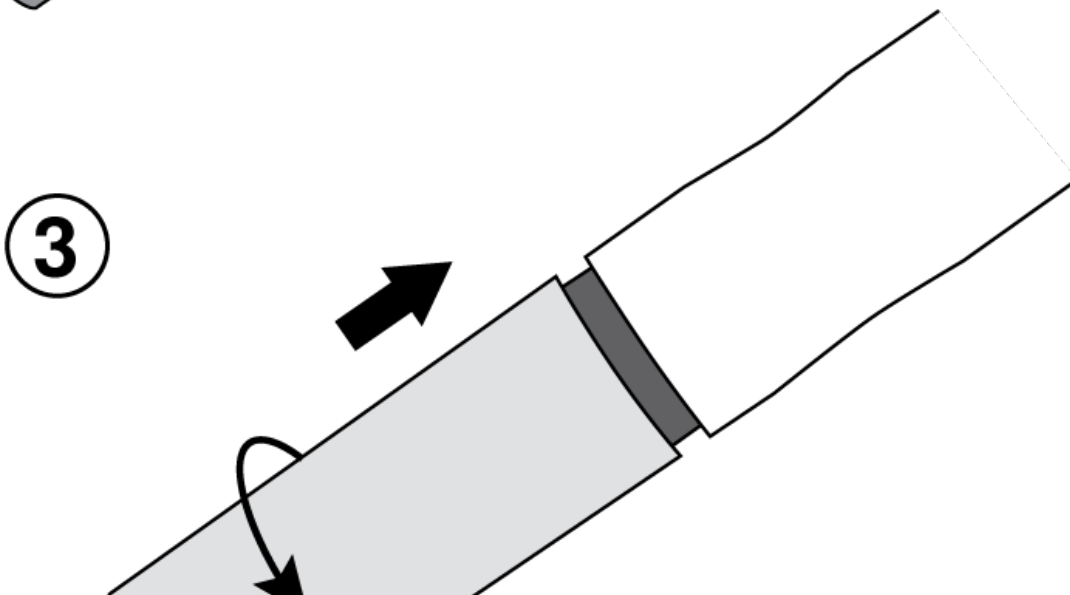
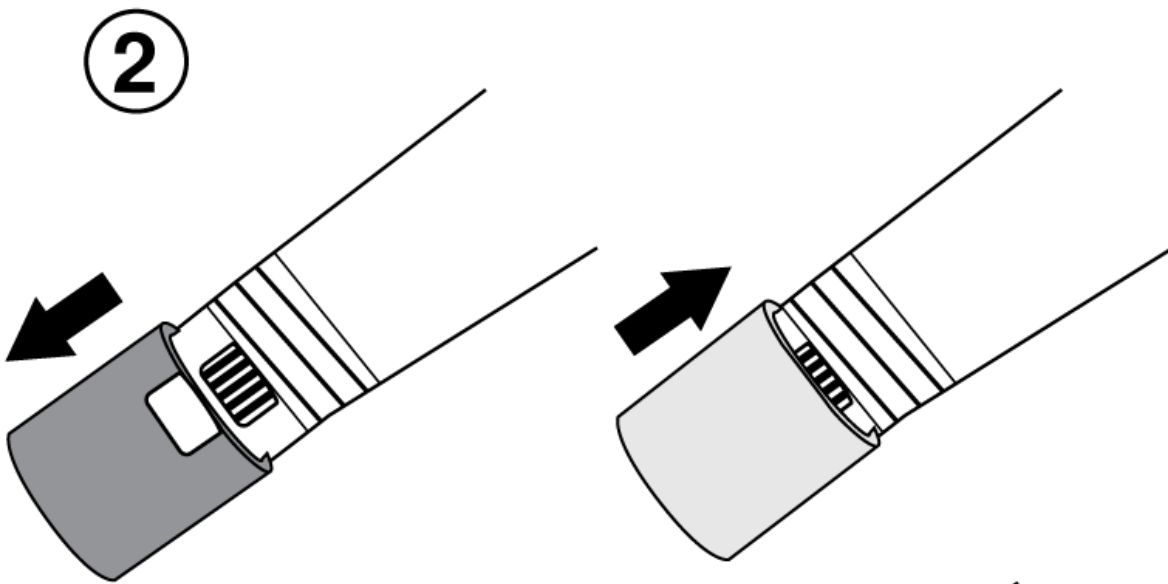
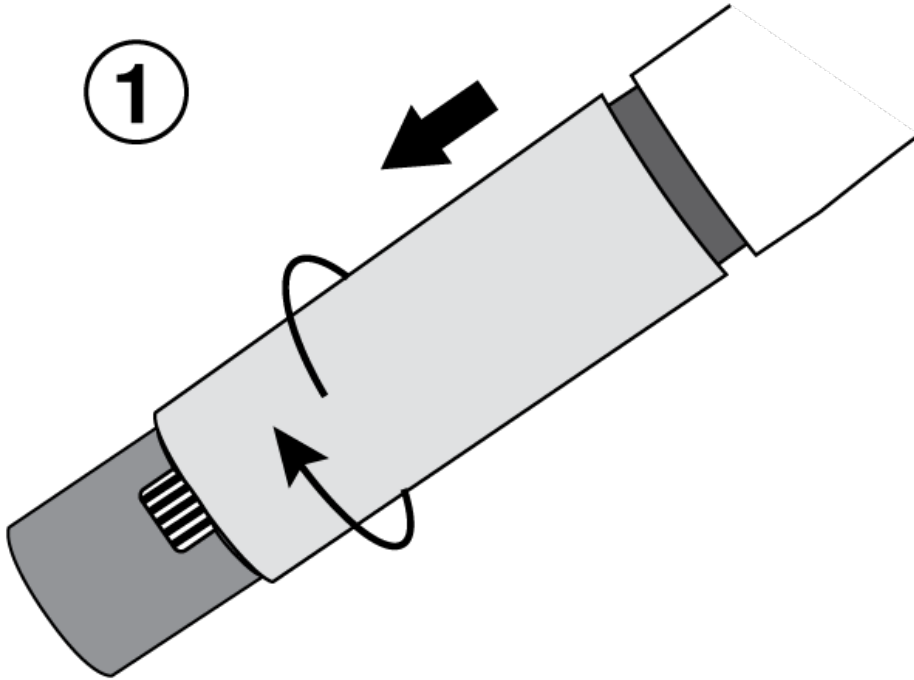



# Shure SB900A Rechargeable Battery

Shure SB900A lithium-ion batteries offer a rechargeable option for powering the transmitters. Batteries quickly charge to 50% capacity in one hour and reach full charge within three hours.

Single chargers and multiple bay chargers are available to recharge the Shure batteries.

**Caution:** Only charge Shure rechargeable batteries with a Shure battery charger.

## Shure SB900A Runtime

2 mW	10 mW	35 mW
Up to 9 hours	Up to 9 hours	Up to 5 hours

## Checking Battery Info

When using a Shure rechargeable battery, the receiver and transmitter home screens display the number of hours and minutes remaining.

Detailed information for the battery is displayed Battery menu of the transmitter: `Utilities > Battery`

- Battery: The chemistry type of for the installed battery (Shure, Alkaline, Lithium, NiMH)
- Bars: Indicates the number of bars displayed
- Time: Battery runtime
- Charge: Percentage of charge capacity
- Health: Percentage of current battery health
- Cycle Count: Total of the number of charging cycles for the installed battery
- Temperature: Battery temperature reported in Celsius and Fahrenheit

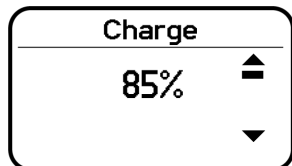

## Important Tips for Care and Storage of Shure Rechargeable Batteries

Proper care and storage of Shure batteries results in reliable performance and ensures a long lifetime.

- Always store batteries and transmitters at room temperature
- Ideally, batteries should be charged to approximately 40% of capacity for long-term storage
- Periodically clean the battery contacts with alcohol to maintain ideal contact
- During storage, check batteries every 6 months and recharge to 40% of capacity as needed

For additional rechargeable battery information, visit [www.shure.com](http://www.shure.com).

## AA Batteries and Transmitter Runtime

Transmitters are compatible with the following AA battery types:





- Alkaline
- Nickel Metal Hydride (NiMH)
- Lithium Primary

A 5-segment battery indicator representing the charge level of the transmitter battery is displayed on the screens of the transmitter and receiver. The following tables contain the approximate remaining transmitter runtime in hours:minutes.







Note: Battery runtimes vary by manufacturer, battery age, and environmental conditions.

### AA Batteries and Transmitter Runtime







Alkaline

Battery Indicator	Approximate Runtime Remaining (hours:minutes)
	8:00 - 6:00
	> 4:00
	> 1:45
	≅ 1:45
	≅ 0:45
	≅ 0:15

NiMH (2700 mAh)

Battery Indicator	Approximate Runtime Remaining (hours:minutes)
	11:00 - 8:00
	> 5:00
	> 2:00
	≅ 2:00
	≅ 0:45
	≅ 0:15

## Lithium Primary (3500 mAh)

Battery Indicator	Approximate Runtime Remaining (hours:minutes)
	14:00 - 10:00
	> 6:00
	> 2:00
	≅ 2:00
	≅ 0:45
	≅ 0:15

## Menu Parameters

The Main menu organizes the available transmitter parameters into three categories:

- Radio
- Audio
- Utilities

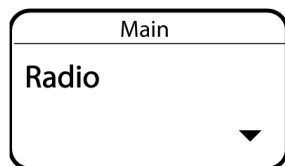

## Tips for Editing Menu Parameters

- To access the menu options from the home screen, select enter. Select enter again to access the menu parameters.
- A menu parameter will blink when editing is enabled
- To increase, decrease or change a parameter, use the arrow buttons
- To save a menu change, select enter
- To exit a menu without saving a change, select exit

## Menu Map

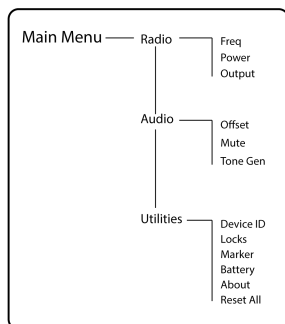

## Menu Parameter Descriptions

### Radio Menu

#### Freq

Press the enter button to enable editing of a group (G:) channel (C:) or frequency (MHz). Use the arrow buttons to adjust the values. To edit the frequency, press the enter button once to edit the first 3 digits, or twice to edit the second 3 digits.

#### Power

Higher RF power settings can extend the range of the transmitter.

Note: Higher RF power settings decrease battery runtime.

#### Output

Sets the RF output to On or Mute.

- On: RF signal is active
- Mute: RF signal is inactive

### Audio Menu

#### Offset

Adjust Offset level to balance mic levels when using two transmitters or when assigning multiple transmitters to receiver slots. Adjustment range: -12 dB to +21 dB.

#### Mute

When enabled, the power switch is configured as a mute switch for the audio:

- Power switch on: Audio signal on
- Power switch off: Audio signal muted

Exit mute mode to return the power switch to its normal functionality.

#### Tone Gen

Transmitter will generate a continuous test tone:

- Freq: The tone can be set to 400 Hz or 1000 Hz.
- Level: Adjusts the output level of the test tone.

## Utilities Menu

### Device ID

Assign a device ID of up to 9 letters or numbers.

### Locks

Locks the transmitter controls and power switch.

- None: The controls are unlocked
- Power: The power switch is locked
- Menu: The menu parameters are locked
- All: The power switch and menu parameters are locked

### Marker

When enabled, press the enter button to drop a marker in Wireless Workbench.

### Battery

Displays battery information:

- Battery Life: Runtime reported in bar display and time (hours:minutes)
- Charge: Percentage of charge capacity
- Health: Percentage of current battery health
- Cycle Count: Total of the number of charging cycles for the installed battery
- Temperature: Battery temperature reported in Celsius and Fahrenheit

### About

Displays the following transmitter information:

- Model: Displays the model number
- Band: Displays the tuning band of the transmitter
- FW Version: Installed firmware
- HW Version: Hardware version
- Serial Num: Serial number

### Reset All

Restores all transmitter parameters to factory settings.

---

## IR Sync

Use IR Sync to form an audio channel between the transmitter and receiver.

Note: The receiver band must match the band of the transmitter.

1. Select a receiver channel.
2. Tune the channel to an available frequency using group scan or manually turn to an open frequency.
3. Power on the transmitter.
4. Press the SYNC button on the receiver.
5. Align the IR windows between the transmitter and the receiver so that the IR LED illuminates red. When complete, Sync Success! appears. The transmitter and receiver are now tuned to the same frequency.

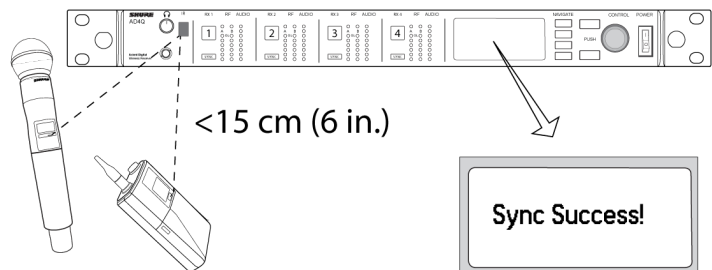

Note:

Any change to the encryption status on the receiver (enabling/disabling encryption) requires a sync to send the settings to the transmitter. New encryption keys for the transmitter and receiver channel are generated on every IR sync, so to request a new key for a transmitter, perform an IR sync with the desired receiver channel.

---

## Setting the Frequency Manually

The transmitter can be manually tuned to a specific group, channel, or frequency.

1. Navigate to the Radio menu and select Freq.
2. Scroll to select G: and C: to edit the group and channel, or select the frequency parameter (MHz). When editing the frequency, press enter once to edit the first 3 digits, or twice to edit the last 3 digits.
3. Use the  $\wedge$   $\vee$  buttons to adjust the group, channel, or frequency.
4. Press enter to save, and then press exit when finished.

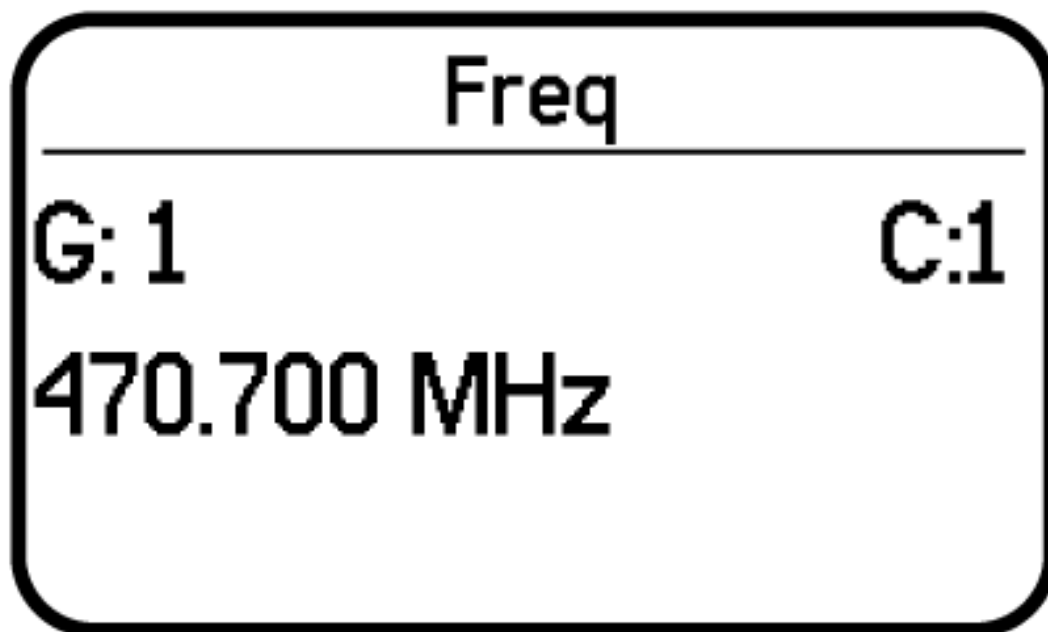

---

## Updating Firmware

Firmware is embedded software in each component that controls functionality. Periodically, new versions of firmware are developed to incorporate additional features and enhancements. To take advantage of design improvements, you can upload and install new versions of the firmware by using the Shure Update Utility. The Shure Update Utility is available for download from <http://www.shure.com/>.

### Firmware Versioning

When performing an update, first download firmware to the receiver, and then update transmitters to the same firmware version to ensure consistent operation.

The firmware numbering for Shure devices uses the following format: MAJOR.MINOR.PATCH (e.g., 1.2.14). At a minimum, all devices on the network (including transmitters), must have the same MAJOR and MINOR firmware version numbers (e.g., 1.2.x).

### Updating the Transmitter

1. Download the firmware to the receiver.
2. Access the following menu from the receiver: `Device Configuration > Tx Firmware Update`.
3. Align the IR ports between the transmitter and the receiver. IR ports must be aligned for the entire download, which can take 50 seconds or longer.

Tip: The red alignment LED will turn on when the alignment is correct.

4. Press ENTER on the receiver to begin the download to the transmitter. The receiver will display the progress of the update as a percentage.

---

## RF Mute

RF Mute prevents transmission of the audio by suppressing the RF signal, while allowing the transmitter to remain powered-on. The home screen displays RF MUTED in this mode.

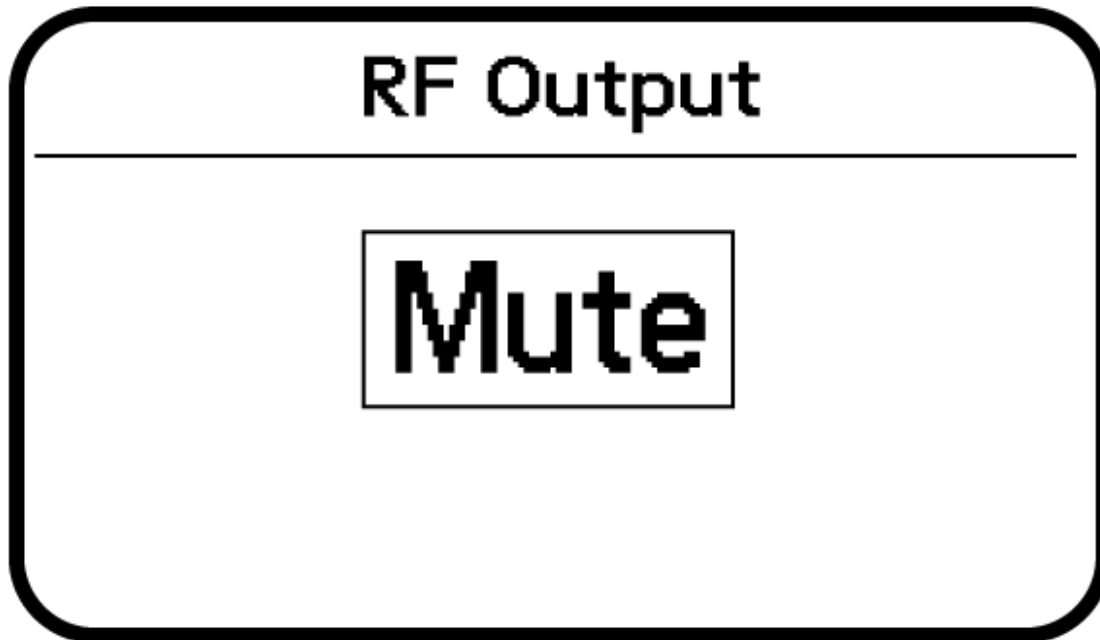

1. From the Radio menu, navigate to Output.
2. Choose one of the following options:
  - On: RF signal is active
  - Mute: RF signal is disabled
3. Press enter to save.

Turning the transmitter off and on, or replacing the battery will restore Output to On.

---

## Power-on RF Mute

Power-on RF Mute places the transmitter in RF Mute mode immediately when turned on.

- Starting with the transmitter off, press and hold the exit button, and then switch on the power
- Continue to hold the exit button until the RF Muted message appears on the home screen

---

## Input Overload

The OVERLOAD message is displayed when the audio input experiences a high-level input signal. Reduce the input signal or move mic away from the source to remove the overload.



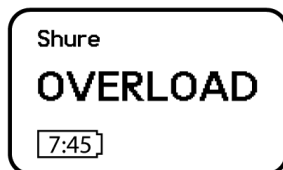

---

## Tone Generator

The transmitter contains an internal tone generator that produces a continuous audio signal. The tone is helpful when conducting a sound check or for troubleshooting the audio signal chain. The level of the tone is adjustable from -60 dB to 0 dB and the frequency can be set to 400 Hz or 1000 Hz.

Tip: Always start with the level set to -60 dB to avoid overloading speakers or headphones.

1. From the Audio menu select Tone Gen.
2. Set the frequency to 400 Hz or 1000 Hz.
3. Select Level and use the arrow buttons adjust the value between -60 dB and 0 dB.

Turn off the tone by selecting Off from the menu or by cycling the transmitter power.

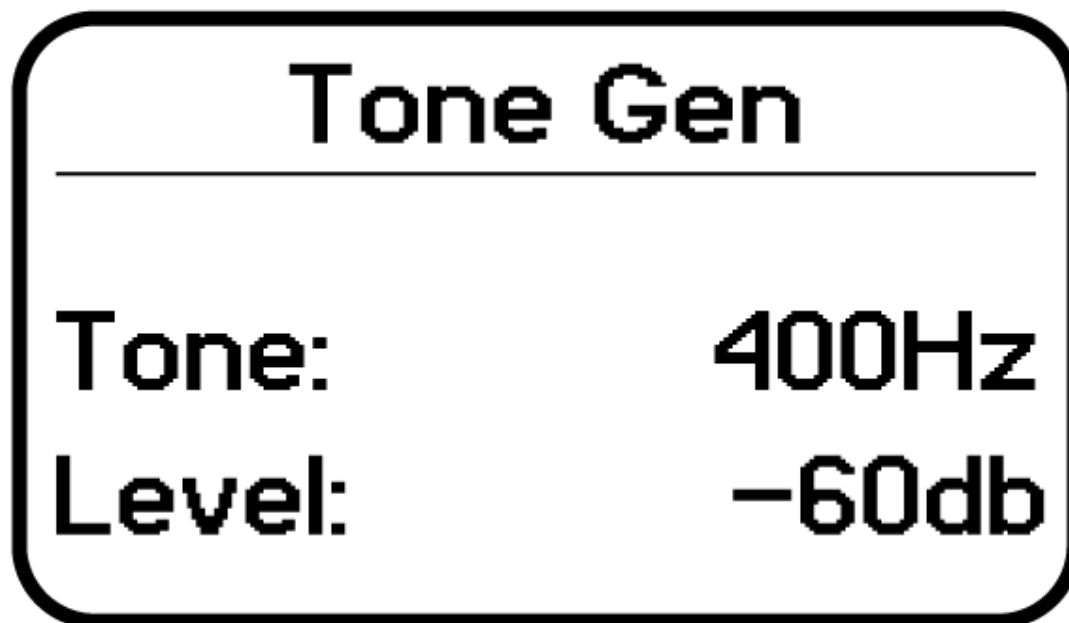

## Matching Audio Levels with Offset

When linking two or more transmitters to a receiver, there may be a difference in volume levels between microphones or instruments. If this occurs, use the Offset function to match the audio levels and eliminate audible volume differences between transmitters. If using a single transmitter, set Offset to 0 dB.

1. Turn on the first transmitter and perform a sound check to test the audio level. Turn off the transmitter when finished.
2. Turn on the second transmitter and perform a sound check to test the audio level. Repeat for any additional transmitters.
3. If there is an audible difference in the sound level between the transmitters, navigate to the Offset menu ( Audio > Offset ) in the transmitter to increase or decrease the Offset in realtime to match the audio levels.

Audio  
Offset: +1dB

## Specifications

### Mic Offset Range

-12 to 21 dB (In 1 dB steps)

### Battery Type

Shure SB900A Rechargeable Li-Ion or LR6 AA batteries 1.5 V

### Battery Runtime

@ 10 mW

Shure SB900A	up to 9 hours
alkaline	up to 8 hours

See Battery Runtime Chart

### Dimensions

256 mm x 51 mm (10.1 in. x 2.0 in.) L x Dia.

### Weight

340 g (12.0 oz.), Without Battery

### Housing

Cast Aluminum

**Operating Temperature Range**

-18°C (0°F) to 50°C (122°F)

Note: Battery characteristics may limit this range.

**Storage Temperature Range**

-29°C (-20°F) to 74°C (165°F)

Note: Battery characteristics may limit this range.

## Audio Input

**Configuration**

Unbalanced

**Maximum Input Level**

1 kHz at 1% THD

145 dB SPL (SM58), typical

Note: Dependent on microphone type

## RF Output

**Antenna Type**

Integrated Single Band Helical

**Occupied Bandwidth**

<200 kHz

**Channel-to-Channel Spacing**

Standard Mode	350 kHz
High Density Mode	125 kHz

varies by region

**Modulation Type**

Shure Axient Digital Proprietary

**Power**

2 mW, 10 mW, 35 mW

See Frequency Range and Output Power table, varies by region

## Frequency Bands and Transmitter RF Power

Band	Frequency Range (MHz)	RF Power (mW) <sup>***</sup>
G53	470 to 510	2/10/35
G54	479 to 565	2/10/20
G55†	470 to 636*	2/10/35
G56	470 to 636	2/10/35
G57	470 to 616*	2/10/35
G62	510 to 530	2/10/35
H54	520 to 636	2/10/35
K53	606 to 698*	2/10/35
K54 △	606 to 663**	2/10/35
K55	606 to 694	2/10/35
K56 ◇	606 to 714	2/10/35
K57 △	606 to 790	2/10/35
K58	622 to 698	2/10/35
L54	630 to 787	2/10/35
R52†	794 to 806	2/10
JB	806 to 810	2/10
X51	925 to 937.5	2/10
X55	941 to 960	2/10/35

\*with a gap between 608 to 614 MHz.

\*\*with a gap between 608 to 614 MHz and a gap between 616 to 653 MHz.

\*\*\*power delivered to the antenna port.

†operation mode varies according to region. In Brazil, High Density mode is used.

△ Output power limited to 10 mW above 608 MHz.

◇ Korea defines power as conducted (ERP) which is 1dB less than declared in table.

## K55 606-694 MHz

<b>Country Code</b> <b>Code de Pays</b> <b>Codice di paese</b> <b>Código de país</b> <b>Länder-Kürzel</b>	<b>Frequency Range</b> <b>Gamme de frequences</b> <b>Gamme di frequenza</b> <b>Gama de frecuencias</b> <b>Frequenzbereich</b>
A, B, BG, CH, CY, CZ, D, DK, EST, F	*
FIN, GB, GR, H, HR, I, IRL, IS, L, LT	*
M, N, NL, P, PL, RO, S, SK, SLO, TR	*
all other countries	*

\* This equipment may be capable of operating on some frequencies not authorized in your region. See Licensing Information.

## G56 470-636 MHz

<b>Country Code</b> <b>Code de Pays</b> <b>Codice di paese</b> <b>Código de país</b> <b>Länder-Kürzel</b>	<b>Frequency Range</b> <b>Gamme de frequences</b> <b>Gamme di frequenza</b> <b>Gama de frecuencias</b> <b>Frequenzbereich</b>
A, B, BG, CH, CY, CZ, D, DK, EST, F	*
FIN, GB, GR, H, HR, I, IRL, IS, L, LT	*
M, N, NL, P, PL, RO, S, SK, SLO, TR	*
all other countries	*

\* This equipment may be capable of operating on some frequencies not authorized in your region. See Licensing Information.

## K57 606-790 MHz

Country Code Code de Pays Codice di paese Código de país Länder-Kürzel	Frequency Range Gamme de frequences Gamme di frequenza Gama de frecuencias Frequenzbereich
A, B, BG, CH, CY, CZ, D, DK, EST, F	*
FIN, GB, GR, H, HR, I, IRL, IS, L, LT	*
M, N, NL, P, PL, RO, S, SK, SLO, TR	*
all other countries	*

\* This equipment may be capable of operating on some frequencies not authorized in your region. See Licensing Information.

## Certifications

Certified under FCC Part 15 and FCC Part 74.

Certified in Canada to RSS-210.

**FCC ID:** DD4AD2G55, DD4AD2G57, DD4AD2K53, DD4AD2K54, DD4AD2X55. **IC:** 616A-AD2G55, 616A-AD2K53.

This device complies with Industry Canada licence-exempt RSS standard(s). Operation of this device is subject to the following two conditions: (1) this device may not cause interference, and (2) this device must accept any interference, including interference that may cause undesired operation of the device. Le présent appareil est conforme aux CNR d'Industrie Canada applicables aux appareils radio exempts de licence. L'exploitation est autorisée aux deux conditions suivantes : (1) l'appareil ne doit pas produire de brouillage, et (2) l'utilisateur de l'appareil doit accepter tout brouillage radioélectrique subi, même si le brouillage est susceptible d'en compromettre le fonctionnement.

Meets essential requirements of the following European Directives:

- WEEE Directive 2002/96/EC, as amended by 2008/34/EC
- RoHS Directive 2011/65/EU

**Note:** Please follow your regional recycling scheme for batteries and electronic waste

This product meets the Essential Requirements of all relevant European directives and is eligible for CE marking.

Hereby, Shure Incorporated declares that the radio equipment is in compliance with Directive 2014/53/EU. The full text of the EU declaration of conformity is available at the following internet address: <http://www.shure.com/europe/compliance> (<http://www.shure.com/europe/compliance>)

Authorized European representative:

Shure Europe GmbH

Headquarters Europe, Middle East & Africa

Department: EMEA Approval

Jakob-Dieffenbacher-Str. 12

75031 Eppingen, Germany

Phone: +49-7262-92 49 0

Fax: +49-7262-92 49 11 4

Email: [EMEAsupport@shure.de](mailto:EMEAsupport@shure.de)

## LICENSING INFORMATION

Licensing: A ministerial license to operate this equipment may be required in certain areas. Consult your national authority for possible requirements. Changes or modifications not expressly approved by Shure Incorporated could void your authority to operate the equipment. Licensing of Shure wireless microphone equipment is the user's responsibility, and licensability depends on the user's classification and application, and on the selected frequency. Shure strongly urges the user to contact the appropriate telecommunications authority concerning proper licensing, and before choosing and ordering frequencies.

## Information to the user

This equipment has been tested and found to comply with the limits for a Class B digital device, pursuant to Part 15 of the FCC Rules. These limits are designed to provide reasonable protection against harmful interference in a residential installation. This equipment generates uses and can radiate radio frequency energy and, if not installed and used in accordance with the instructions, may cause harmful interference to radio communications. However, there is no guarantee that interference will not occur in a particular installation. If this equipment does cause harmful interference to radio or television reception, which can be determined by turning the equipment off and on, the user is encouraged to try to correct the interference by one or more of the following measures:

- Reorient or relocate the receiving antenna.
- Increase the separation between the equipment and the receiver.
- Connect the equipment to an outlet on a circuit different from that to which the receiver is connected.
- Consult the dealer or an experienced radio/TV technician for help.

This device operates on frequencies shared with other devices. Consult the Federal Communications Commission White Space Database Administration website to determine available channels in your area prior to operation.

No user-operated control of power, frequency, or other parameters are available beyond those specified in this operating manual.

## Australia Warning for Wireless

This device operates under an ACMA class licence and must comply with all the conditions of that licence including operating frequencies. Before 31 December 2014, this device will comply if it is operated in the 520-820 MHz frequency band. **WARNING:** After 31 December 2014, in order to comply, this device must not be operated in the 694-820 MHz band.

### Canada Warning for Wireless

This device operates on a no-protection, no-interference basis. Should the user seek to obtain protection from other radio services operating in the same TV bands, a radio licence is required. For further details, consult Innovation, Science and Economic Development Canada's document Client Procedures Circular CPC-2-1-28, Voluntary Licensing of Licence-Exempt Low-Power Radio Apparatus in the TV Bands.

Ce dispositif fonctionne selon un régime de non-brouillage et de non-protection. Si l'utilisateur devait chercher à obtenir une certaine protection contre d'autres services radio fonctionnant dans les mêmes bandes de télévision, une licence radio serait requise. Pour en savoir plus, veuillez consulter la Circulaire des procédures concernant les clients CPC-2-1-28, Délivrance de licences sur une base volontaire pour les appareils radio de faible puissance exempts de licence et exploités dans les bandes de télévision d'Innovation, Sciences et Développement économique Canada.

This device complies with Industry Canada licence-exempt RSS standard(s). Operation of this device is subject to the following two conditions: (1) this device may not cause interference, and (2) this device must accept any interference, including interference that may cause undesired operation of the device.

Le présent appareil est conforme aux CNR d'Industrie Canada applicables aux appareils radio exempts de licence. L'exploitation est autorisée aux deux conditions suivantes : (1) l'appareil ne doit pas produire de brouillage, et (2) l'utilisateur de l'appareil doit accepter tout brouillage radioélectrique subi, même si le brouillage est susceptible d'en compromettre le fonctionnement.