

SHURE®

LEGENDARY
PERFORMANCE™

BRH440M/BRH441M Broadcast Headsets



English

Français

Deutsch

Español

Italiano

日本語

한국어

中文

Bahasa Indonesia





©2014 Shure Incorporated
27A20060 (Rev. 8)

Printed in China

BRH440M and BRH441M Broadcast Headset

SAFETY PRECAUTIONS

The possible results of incorrect use are marked by one of the two symbols—"WARNING" and "CAUTION"—depending on the imminence of the danger and the severity of the damage.

	WARNING: Ignoring these warnings may cause severe injury or death as a result of incorrect operation.
	CAUTION: Ignoring these cautions may cause moderate injury or property damage as a result of incorrect operation.

CAUTION

- Never disassemble or modify the device, as failures may result.
- Do not subject to extreme force and do not pull on the cable or failures may result.
- Keep the product dry and avoid exposure to extreme temperatures and humidity.

WARNING

- If water or other foreign objects enter the inside of the device, fire or electric shock may result.
- Do not attempt to modify this product. Doing so could result in personal injury and/or product failure.

This device is able to produce sound volume higher than 85 dB SPL. Please check your maximum allowed continuous noise exposure level based on your national employment protection requirements.

WARNING

LISTENING TO AUDIO AT EXCESSIVE VOLUMES CAN CAUSE PERMANENT HEARING DAMAGE. USE AS LOW A VOLUME AS POSSIBLE. Over exposure to excessive sound levels can damage your ears resulting in permanent noise-induced hearing loss (NIHL). Please use the following guidelines established by the Occupational Safety Health Administration (OSHA) on maximum time exposure to sound pressure levels before hearing damage occurs.

90 dB SPL at 8 hours	95 dB SPL at 4 hours	100 dB SPL at 2 hours	105 dB SPL at 1 hour
110 dB SPL at ½ hour	115 dB SPL at 15 minutes	120 dB SPL Avoid or damage may occur	

WARNING: This product contains a chemical known to the State of California to cause cancer and birth defects or other reproductive harm.

BRH440M and BRH441M Broadcast Headsets

The BRH441M Broadcast Headset and the BRH440M Broadcast Stereo Headset are developed especially for use in broadcast and media production. Circumaural ear cups block out background noise, and the dynamic, cardioid microphone delivers natural, highly intelligible vocal reproduction. Wearable on the left or right side, the flexible boom features a flip-up mute function that deactivates the microphone when raised vertically. A detachable cable with unterminated ends enables connection to a variety of devices, and is easily replaceable for a lifetime of use. The BRH440M features stereo monitoring, while the BRH441M leaves one ear open to the surrounding environment.

- Closed-back, circumaural design provides excellent isolation from background noise
- Dynamic microphone delivers natural, highly intelligible vocal reproduction with cardioid polar pattern and frequency response optimized for communication in loud environments
- Ergonomic, lightweight design with adjustable, padded headband for long wearing comfort
- Flexible boom microphone pivots 250 degrees for left or right side wear
- Flip-up mute function deactivates the microphone when boom is raised vertically
- Single-side, detachable cable with unterminated ends (stripped and tinned) enables connection to a variety of devices
- User-replaceable cable, earpads, and windscreen for a long product life
- Legendary Shure durability to withstand the rigors of professional use

Care and Maintenance

Clean using a soft, damp cloth.

CAUTION: Do not use cleansers that contain solvents. Keep liquid and foreign objects out of the driver openings.

Detachable Cable

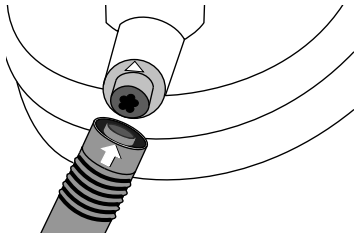

Attach the cable by aligning the arrows and pressing firmly into place until locked.

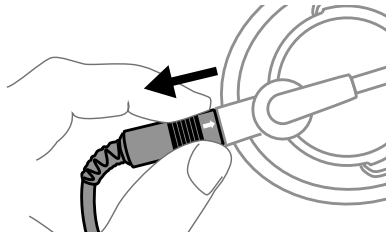

Pull on the knurled collar to disengage lock and remove cable.

Wearing the Headset

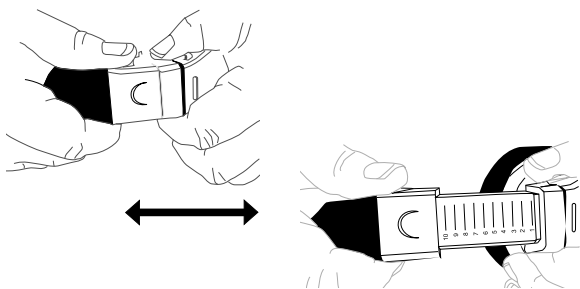

Adjust the headband for a comfortable fit.

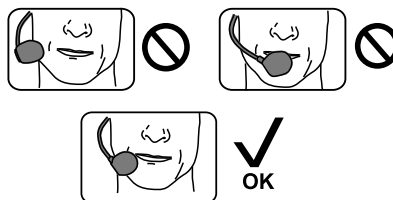

Position the boom so the microphone is within 13 mm (1/2 inch) of the right corner of your mouth. To avoid "popping" or other breath noise, do not place directly in front of mouth.

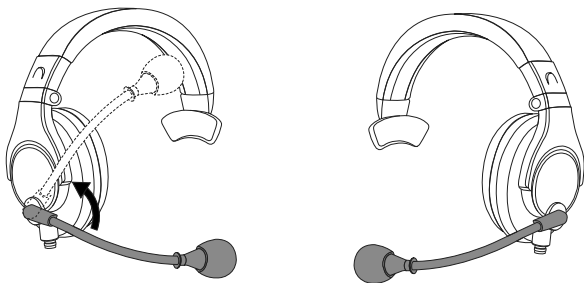

The boom swivel allows the headset to be worn with the microphone on the left or the right side.

Flip-Up Mute Function

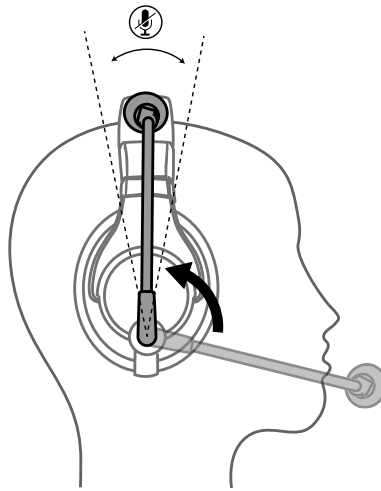

Swivel the boom vertically to the indented position at the headband to mute the microphone.

Replacement Parts

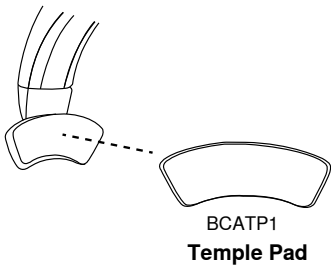

BCATP1
Temple Pad

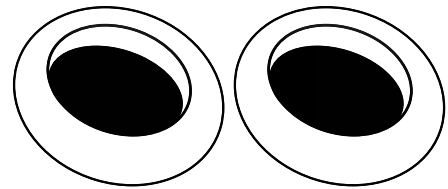

BCAEC440
1 Pair of Replacement Earcup Pads

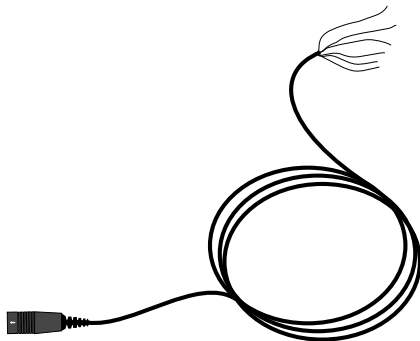

BCASCA1
Replacement Cable

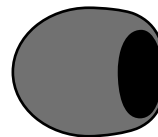

BCAWS1
Windscreen

Specifications

Weight

BRH440M	Net (without cable)
376 g (13.26 oz.)	Packaged
0.8 kg (1.75 lbs)	BRH441M
Net (without cable)	240 g (8.5 oz.)
Packaged	0.69 kg (1.52 lbs)

Cable

2.1 m, detachable, non-PVC, 6-conductor, unterminated

Environmental Conditions

Operating Temperature	18° to 60° C (0° to 140° F)
Storage Temperature	-29° to 74° C (-29° to 165° F)
Relative Humidity	0 to 95%

Microphone

Type

Dynamic, Neodymium magnet, 12.5 mm

Polar Pattern

Cardioid

Frequency Response

50 to 15,000 Hz

Output Impedance

150 Ω

Sensitivity

at 1 kHz, open circuit voltage

-66.5 dBV/Pa* (0.47 mV)

*1 Pa = 94 dB SPL

Polarity

Positive pressure on diaphragm produces positive voltage on pin 1 (red wire) with respect to pin 2 (black wire).

Headphone

Transducer Type

Dynamic, Neodymium magnet

Driver Size

40 mm

Frequency Response

20 to 18,000 Hz

Sensitivity

@ 1 kHz

101 dB SPL/mW

Impedance

@ 1 kHz

300 Ω

Maximum Input Power

1000 mW

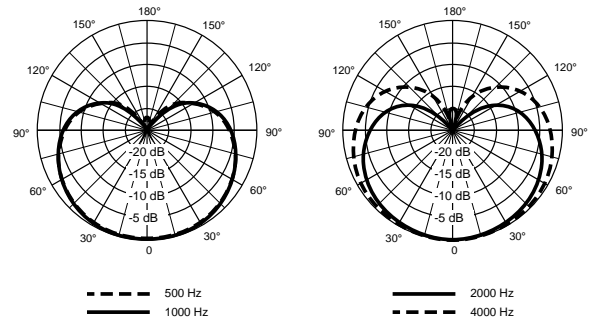
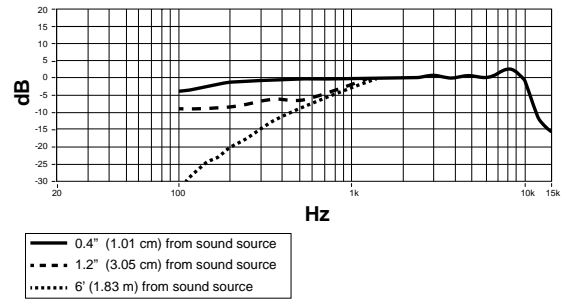

BRH Broadcast Cable Accessories

The following tables describe wiring for BRH detachable cables. All BRH detachable cables contain six conductors with discrete termination at the Shure 6-pin connector that plugs into the headset. For pre-terminated cables, conductors (and signal) are tied to common contacts at the other end of the cable where shown.

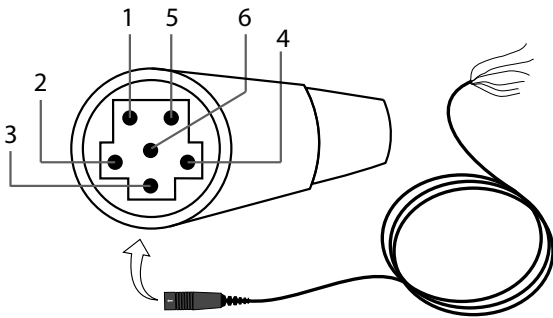

6-Pin Headset Connector

BCASCA1 (unterminated)

Signal	Wire	6-Pin Headset Connector
Mic +	Red	1
Mic -	Black	2
Mic Ground	Shield (uncoated)	3
Headphone Audio 1	Orange	4
Headphone Audio 2 (boom side)	Green	5
Headphone Audio Ground	White	6

BCASCA-XLR4

4-Pin XLR	Signal	Wire	6-Pin Headset Connector
1	Mic -	Black	2
2	Mic +	Red	1
3	Mic Ground	Shield (uncoated)	3
	Headphone Audio Ground	White	6
4	Headphone Audio 1	Orange	4
	Headphone Audio 2 (boom side)	Green	5

BCASCA-XLR5

5-Pin XLR	Signal	Wire	6-Pin Headset Connector
1	Mic -	Black	2
2	Mic +	Red	1
3	Mic Ground	Shield (uncoated)	3
	Headphone Audio Ground	White	6
4	Headphone Audio 2 (boom side)	Green	5
5	Headphone Audio 1	Orange	4

BCASCA-XLR3QI

Connector	Contact	Signal	Wire	6-Pin Headset Connector
3-Pin XLR	1	Mic Ground	Shield (uncoated)	3
	2	Mic +	Red	1
	3	Mic -	Black	2
6.3 mm (1/4") TRS	Sleeve	Headphone Audio Ground	White	6
	Tip	Headphone Audio 2 (boom side)	Green	5
	Ring	Headphone Audio 1	Orange	4

CERTIFICATION

Eligible to bear CE Marking. Conforms to European EMC Directive 2004/108/EC. Meets Harmonized Standards EN55103-1:1996 and EN55103-2:1996, for residential (E1) and light industrial (E2) environments.

The Declaration of Conformity can be obtained from:

Authorized European representative:
Shure Europe GmbH
Headquarters Europe, Middle East & Africa
Department: EMEA Approval
Jakob-Dieffenbacher-Str. 12
75031 Eppingen, Germany
Phone: 49-7262-92 49 0
Fax: 49-7262-92 49 11 4
Email: info@shure.de

HOMOLOGATION

Autorisé à porter la marque CE. Conforme à la directive européenne CEM 2004/108/CE. Conforme aux normes harmonisées EN55103-1:1996 et EN55103-2:1996 pour les environnements résidentiels (E1) et d'industrie légère (E2).

La déclaration de conformité peut être obtenue de l'adresse suivante:

Représentant agréé européen :
Shure Europe GmbH
Siège Europe, Moyen-Orient et Afrique
Homologation EMEA
Jakob-Dieffenbacher-Str. 12
75031 Eppingen, Allemagne
Téléphone : 49-7262-92 49 0
Télécopie : 49-7262-92 49 11 4
Courriel : info@shure.de

ZERTIFIZIERUNG

Zur CE-Kennzeichnung berechtigt. Entspricht der europäischen Richtlinie zur elektromagnetischen Verträglichkeit 2004/108/EG. Entspricht den Anforderungen der harmonisierten Normen EN55103-1:1996 und EN55103-2:1996 für Wohngebiete (E1) und Leichtindustriegebiete (E2).

Die Konformitätserklärung ist über die unten stehende Adresse erhältlich:

Bevollmächtigter Vertreter in Europa:
Shure Europe GmbH
Headquarters Europe, Middle East & Africa
Abteilung: EMEA-Zulassung
Jakob-Dieffenbacher-Str. 12
75031 Eppingen, Deutschland
Telefon: +49 (0) 7262 9249 0
Telefax: +49 (0) 7262 9249 114
E-Mail: info@shure.de

CERTIFICACIONES

Califica para llevar la marca CE. Cumple con la directiva europea de EMC 2004/108/EC. Satisface las normas armonizadas EN55103-1:1996 y EN55103-2:1996 para entornos de uso residencial (E1) e industrial ligero (E2).

La declaración de conformidad se puede obtener de la siguiente dirección:

Representante autorizado en Europa:
Shure Europe GmbH
Casa matriz para Europa, Medio Oriente y Africa
Aprobación para región de EMEA
Jakob-Dieffenbacher-Str. 12
75031 Eppingen, Alemania
Teléfono: 49-7262-92 49 0
Fax: 49-7262-92 49 11 4
Correo electrónico: info@shure.de

認証

CEマーキングに適合。欧州EMC指令2004/108/ECに適合。住宅(E1)および軽工業(E2)環境に関し、EN55103-1:1996およびEN55103-2:1996の整合規格に対応。

CE適合宣言書は以下より入手可能です: www.shure.com/europe/compliance

ヨーロッパ認可代理店:
Shure Europe GmbH
ヨーロッパ、中東、アフリカ地区本部:
部門: EMEA承認
Jakob-Dieffenbacher-Str. 12
75031 Eppingen, Germany
Tel: 49-7262-92 49 0
Fax: 49-7262-92 49 11 4
Eメール: EMEAsupport@shure.de

OMOLOGAZIONI

Contrassegnabile con il marchio CE. Conforme alla direttiva europea sulla compatibilità elettromagnetica 2004/108/CE. Conforme alle norme armonizzate EN55103-1:1996 ed EN55103-2:1996 per l'uso in ambienti domestici (E1) e industriali leggeri (E2).

La dichiarazione di conformità può essere ottenuta da:

Rappresentante europeo autorizzato:
Shure Europe GmbH
Sede per Europa, Medio Oriente e Africa
Approvazione EMEA
Jakob-Dieffenbacher-Str. 12
75031 Eppingen, Germania
Telefono: 49-7262-92 49 0
Fax: 49-7262-92 49 11 4
E-mail: info@shure.de

인증

CE 마크에 적합. 유럽 EMC Directive 2004/108/EC를 준수합니다. 주거용 (E1) 및 경공업용 (E2) 환경을 위한 표준 EN55103-1:1996 과 EN55103-2:1996 에 부합합니다.

CE 적합성 선언은 다음 사이트에서 확인할 수 있습니다: www.shure.com/europe/compliance

공인 유럽 대리점:
Shure Europe GmbH
유럽, 중동, 아프리카 본부
부서: EMEA 승인
Jakob-Dieffenbacher-Str. 12
75031 Eppingen, Germany
전화: 49-7262-92 49 0
팩스: 49-7262-92 49 11 4
이메일: EMEAsupport@shure.de

认证

允许使用 CE 标志。符合欧盟 EMC 指导原则 2004/108/EC。符合 Harmonized 标准 EN55103-1 : 1996 和 EN55103-2 : 1996 适用于民用 (E1) 和轻工业 (E2) 环境。

可从以下地址获得“CE 符合性声明” : www.shure.com/europe/compliance

授权的欧洲代表 :
Shure Europe GmbH
欧洲、中东、非洲总部
部门 : 欧洲、中东、非洲批准部
Jakob-Dieffenbacher-Str. 12
75031 Eppingen, Germany
电话 : 49-7262-92 49 0
传真 : 49-7262-92 49 11 4
电子邮件 : EMEAsupport@shure.de

Sertifikasi

Memenuhi syarat untuk memakai tanda CE. Sesuai Petunjuk EMC Eropa 2004/108/EC. Memenuhi Standar Harmonis EN55103-1:1996 dan EN55103-2:1996, untuk lingkungan tempat tinggal (E1) dan lingkungan industri kecil (E2).

Pernyataan Kesesuaian CE bisa diperoleh di: www.shure.com/europe/compliance

Perwakilan Eropa Resmi:
Shure Europe GmbH
Markas Besar Eropa, Timur Tengah & Afrika
Bagian: Persetujuan EMEA
Jakob-Dieffenbacher-Str. 12
75031 Eppingen, Germany
Telepon: 49-7262-92 49 0
Faks: 49-7262-92 49 11 4
Email: EMEAsupport@shure.de

LIMITED WARRANTY

Shure Incorporated ("Shure") hereby warrants to the original consumer purchaser only that, except as otherwise specified below, this product will be free in normal use of any defects in materials and workmanship for a period of two (2) years from the consumer's original date of purchase directly from Shure or from a Shure-authorized reseller.

Any rechargeable batteries contained in or packaged with this product are so warranted for a period of one (1) year from the consumer's original date of purchase. However, rechargeable batteries are consumable and their capacity will be reduced over time based on temperature, amount of time in storage, charging cycles, and other factors; hence reduction in battery capacity does not constitute a defect in material or workmanship.

At its sole option, Shure will repair or replace the defective product and promptly return it to you. In order for this warranty to be valid, the consumer must, at the time the product is returned, provide proof of purchase in the form of the original purchase receipt directly from Shure or from a Shure-authorized reseller. If Shure elects to replace the defective product, then Shure reserves the right to replace the defective product with another product of the same model or a model of at least comparable quality and features in Shure's sole determination.

If you believe this product is defective within the warranty period, carefully repack the unit, insure it and return it with proof of purchase, postage prepaid, to Shure Incorporated, Attention: Service Department, at the address below.

Outside of the United States, return the product to your dealer or Authorized Service Center. Addresses are listed on www.Shure.com or can be obtained by contacting Shure at the address listed below.

This warranty is not transferable. This warranty does not apply in cases of abuse or misuse of the product, use contrary to Shure's instruction, ordinary wear and tear, an act of God, negligent use, purchase from a party other than Shure or a Shure-authorized reseller, unauthorized repair, or modification of the product.

ALL IMPLIED WARRANTIES OF MERCHANTABILITY OR FITNESS FOR A PARTICULAR PURPOSE ARE HEREBY DISCLAIMED TO THE EXTENT PERMITTED UNDER APPLICABLE LAWS AND, TO THE EXTENT NOT PERMITTED, ARE HEREBY LIMITED TO THE DURATION AND TERMS OF THIS WARRANTY. SHURE ALSO HEREBY DISCLAIMS ALL LIABILITY FOR INCIDENTAL, SPECIAL, OR CONSEQUENTIAL DAMAGES.

Some states do not allow limitations on how long an implied warranty lasts, or the exclusion or limitation of incidental or consequential damages, so the above limitation may not apply to you. This warranty gives you specific legal rights, and you may have other rights which vary from state to state.

This warranty does not restrict the rights of the consumer mandated under applicable laws.

THIS WARRANTY SUPERSEDES ALL OTHER WARRANTIES THAT ARE ASSOCIATED OR INCLUDED WITH THIS PRODUCT, EXCEPT THAT ANY SOFTWARE CONTAINED IN OR PACKAGED WITH THIS PRODUCT IS EXCLUDED FROM THIS WARRANTY AND INSTEAD SHALL BE COVERED BY THE WARRANTY, IF ANY, PROVIDED IN SHURE'S END USER LICENSE AGREEMENT ACCOMPANYING SUCH SOFTWARE.

FOR ORIGINAL PURCHASES IN AUSTRALIA ONLY

LIMITED WARRANTY AGAINST DEFECTS

Shure Incorporated ("Shure") hereby warrants to the original consumer purchaser in Australia only that, except as otherwise specified below, this product will be free in normal use of any defects in materials and workmanship for a period of two (2) years from the consumer's original date of purchase directly from Shure or from a Shure-authorized reseller.

Any rechargeable batteries contained in or packaged with this product are so warranted for a period of one (1) year from the consumer's original date of purchase. However, rechargeable batteries are consumable and their capacity will be reduced over time based on temperature, amount of time in storage, charging cycles, and other factors; hence reduction in battery capacity does not constitute a defect in material or workmanship.

At its sole option, Shure will repair or replace the defective product and promptly return it to you. In order for this warranty to be valid, the consumer must, at the time the product is returned, provide proof of purchase in the form of the original purchase receipt directly from Shure or from a Shure-authorized reseller. If Shure elects to replace the defective product, then Shure reserves the right to replace the defective product with another product of the same model or a model of at least comparable quality and features in Shure's sole determination.

If you believe this product is defective within the warranty period, carefully repack the unit, insure it (at your expense, if you want the benefit of insurance) and return it with proof of purchase, postage paid by you, to Shure Incorporated, Attention: Service Department, at the address below.

Outside of the United States, return the product to your dealer or Authorized Service Center. Addresses are listed on www.Shure.com or can be obtained by contacting Shure at the address listed below.

This warranty is not transferable. This warranty does not apply in cases of abuse or misuse of the product, use contrary to Shure's instruction, ordinary wear and tear, an act of God, negligent use, purchase from a party other than Shure or a Shure-authorized reseller, unauthorized repair, or modification of the product.

ALL IMPLIED WARRANTIES OF MERCHANTABILITY OR FITNESS FOR A PARTICULAR PURPOSE ARE HEREBY DISCLAIMED TO THE EXTENT PERMITTED UNDER APPLICABLE LAWS AND, TO THE EXTENT NOT PERMITTED, ARE HEREBY LIMITED TO THE EXTENT PERMITTED TO THE DURATION AND TERMS OF THIS WARRANTY. SHURE ALSO HEREBY DISCLAIMS ALL LIABILITY FOR INCIDENTAL, SPECIAL, OR CONSEQUENTIAL DAMAGES FOR ANY PURCHASER ACQUIRING THIS PRODUCT, EXCEPT THAT THIS DOES NOT CONSTITUTE A DISCLAIMER OF RIGHTS GUARANTEED TO ANY "CONSUMER" UNDER THE AUSTRALIAN CONSUMER LAW.

This warranty gives purchasers of this product in Australia specific legal rights which are in addition to the rights and remedies of consumers under the Australian Consumer Law, which cannot be excluded or limited. If you are a "consumer" under the Australian Consumer Law, you are entitled to a replacement or refund for a major failure and for compensation for any other reasonably foreseeable loss or damage. You are also entitled to have the goods repaired or replaced if the goods fail to be of acceptable quality and the failure does not amount to a major failure.

THIS WARRANTY SUPERSEDES ALL OTHER WARRANTIES THAT ARE ASSOCIATED OR INCLUDED WITH THIS PRODUCT, EXCEPT THAT ANY SOFTWARE CONTAINED IN OR PACKAGED WITH THIS PRODUCT IS EXCLUDED FROM THIS WARRANTY AND INSTEAD SHALL BE COVERED BY THE WARRANTY, IF ANY, PROVIDED IN SHURE'S END USER LICENSE AGREEMENT ACCOMPANYING SUCH SOFTWARE.

Service Centers

United States, Canada, Latin America, Carribean
Shure Incorporated
Attn: Service Department
5800 W. Touhy Avenue
Niles, IL 60714-4608 U.S.A.

Europe, Middle East, and Africa
Shure Europe GmbH
Attn: Service
Jakob-Dieffenbacher-Str. 12
74078 Eppingen, Germany

Asia
Shure Asia Limited
Attn: Service
22/F, 625 King's Road
North Point, Island East
Hong Kong

GARANTIE LIMITÉE

Shure Incorporated (« Shure ») garantit par la présente seulement au consommateur acquéreur d'origine, sauf indication contraire ci-dessous, pour un usage normal, que ce produit est exempt de défauts de matériaux et de fabrication pour une période de deux (2) ans à compter de la date d'achat d'origine par le consommateur directement à Shure ou à un revendeur Shure agréé.

Tout accu rechargeable contenu dans ce produit ou emballé avec lui est garanti pour une période d'un (1) an à compter de la date d'achat d'origine par le consommateur. Toutefois, les accus rechargeables sont des consommables et leur capacité diminue avec le temps en fonction de la température, de la durée de stockage, des cycles de charge et d'autres facteurs ; par conséquent, la réduction de la capacité de l'accu ne constitue pas un défaut de matériaux ou de fabrication.

À sa seule appréciation, Shure réparera ou remplacera les produits défectueux et les retournera promptement à leur propriétaire. Pour que cette garantie soit valide, le consommateur doit fournir, au moment où le produit est retourné, la preuve d'achat sous la forme de la facture d'origine reçue directement de Shure ou d'un revendeur Shure agréé. Si Shure choisit de remplacer le produit défectueux, Shure se réserve le droit de remplacer le produit défectueux par un autre produit du même modèle ou par un modèle de qualité et aux fonctions au moins comparables à la seule discrétion de Shure.

Si le produit est considéré comme défectueux au cours de la période de garantie, le remballer soigneusement, l'assurer et le retourner accompagné de la preuve d'achat, en port payé, à Shure Incorporated, Attention: Service Department, à l'adresse ci-dessous.

À l'extérieur des États-Unis, renvoyer le produit au distributeur ou au Centre de réparations agréé. Les adresses sont listées sur www.Shure.com ou peuvent être obtenues en contactant Shure à l'adresse indiquée ci-dessous.

Cette garantie n'est pas transférable. Cette garantie n'est pas applicable en cas d'utilisation abusive ou incorrecte du produit, d'utilisation contraire aux instructions de Shure, d'usure normale, de catastrophes naturelles, d'utilisation négligente, d'achat auprès d'une partie autre que Shure ou un revendeur Shure agréé, de réparation non autorisée ou de modification du produit.

TOUTES LES GARANTIES IMPLICITES DE QUALITÉ MARCHANDE OU D'APTITUDE À UN USAGE PARTICULIER SONT REFUSÉES PAR LA PRÉSENTE DANS LA MESURE PERMISE PAR LA LOI ET, DANS LA MESURE OÙ CE N'EST PAS PERMIS, SONT PAR LA PRÉSENTE LIMITÉES À LA DURÉE ET AUX TERMES DE CETTE GARANTIE. EN OUTRE, SHURE N'ACCEPTE AUCUNE RESPONSABILITÉ CONCERNANT DES DOMMAGES FORTUITS, SPÉCIAUX OU CONSÉQUENTS.

Certains états n'acceptent pas les limitations sur la durée des garanties implicites ni l'exclusion ou la limitation des dommages fortuits ou conséquents et par suite, il est possible que la limitation ci-dessus ne soit pas applicable. La présente garantie donne des droits légaux spécifiques et l'utilisateur peut également avoir d'autres droits qui varient d'une province à l'autre.

Cette garantie ne limite pas les droits du consommateur autorisés par les lois applicables.

CETTE GARANTIE REMPLACE TOUTES LES AUTRES GARANTIES INCLUSES AVEC CE PRODUIT OU QUI LUI SONT ASSOCIÉES, EXCEPTÉ QUE TOUT LOGICIEL CONTENU DANS CE PRODUIT OU EMBALLÉ AVEC LUI EST EXCLU DE LA PRÉSENTE GARANTIE ET SERA COUVERT À LA PLACE PAR LA GARANTIE FOURNIE LE CAS ÉCHÉANT PAR LE CONTRAT DE LICENCE POUR LES UTILISATEURS FINAUX DE SHURE QUI ACCOMPAGNE LE LOGICIEL.

GARANTIA LIMITADA

Shure Incorporated ("Shure") garantiza por este medio al comprador original del producto solamente que, salvo indicación contraria en el presente, este producto, utilizado normalmente, estará libre de defectos de materiales y de fabricación por un periodo de (2) años contados a partir de la fecha de compra original directamente de Shure o de un revendedor autorizado por Shure.

Las baterías recargables contenidas en este producto o empacadas con el mismo se encuentran igualmente garantizadas por un período de un (1) año contado a partir de la fecha de compra original. Sin embargo, las baterías recargables son artículos consumibles y su capacidad se reducirá con el tiempo dependiendo de la temperatura, el tiempo de almacenamiento, los ciclos de carga y otros factores; por lo que la reducción en la capacidad de la batería no constituye un defecto de materiales ni de fabricación.

Shure reparará o reemplazará exclusivamente a discreción propia el producto defectuoso y lo devolverá oportunamente al cliente. Para que esta garantía tenga validez, el consumidor deberá, al momento de devolver el producto, presentar un comprobante de compra en forma del recibo de compra original directamente de Shure o de un revendedor autorizado por Shure. Si Shure elige reemplazar el producto defectuoso, Shure se reserva el derecho de reemplazar el producto defectuoso por otro del mismo modelo o por un modelo de calidad y características comparables, a discreción exclusiva de Shure.

Si usted cree que el producto está defectuoso dentro del período de la garantía, embale cuidadosamente la unidad junto con su comprobante de compra y envíela porte pagado a Shure Incorporated, atención: Service Department, a la dirección que se da abajo.

Fuera de los EE.UU., devuelva el producto al distribuidor más cercano o al centro de servicio autorizado de productos Shure. Las direcciones se indican en www.Shure.com o pueden obtenerse comunicándose con Shure en la dirección dada abajo.

Esta garantía no es transferible. La garantía no tiene vigencia en caso de abuso o mal uso del producto, uso contrario a las instrucciones dadas por Shure, desgaste ordinario, actos de fuerza mayor, uso negligente, compra de una entidad diferente de Shure o de un revendedor autorizado por Shure, reparaciones no autorizadas o modificación del producto.

POR ESTE MEDIO SE DESCARGA LA RESPONSABILIDAD DE TODAS LAS GARANTIAS IMPLICITAS DE UTILIDAD COMERCIAL O IDONEIDAD PARA UN FIN PARTICULAR HASTA DONDE LO PERMITAN LAS LEYES CORRESPONDIENTES, Y EN EL CASO DE NO PERMITIRSE EL DESCARGO DE RESPONSABILIDADES, TALES GARANTIAS QUEDAN LIMITADAS POR ESTE MEDIO A LA DURACION Y TERMINOS DE ESTA GARANTIA. SHURE TAMBIEN DESCARGA TODA RESPONSABILIDAD POR DAÑOS INCIDENTALES, ESPECIALES O CONSECUENTES.

Algunos estados no permiten la fijación de limitaciones a la duración de una garantía implícita ni la exclusión o limitación de daños incidentes o consecuentes, por lo cual la limitación anterior puede no corresponder en su caso. Esta garantía le otorga derechos legales específicos; se puede contar con otros derechos adicionales que varían entre un estado y otro.

Esta garantía no restringe los derechos del consumidor que se estipulen bajo leyes aplicables.

ESTA GARANTIA SUSTITUYE A TODAS LAS DEMAS GARANTIAS RELACIONADAS O INCLUIDAS CON ESTE PRODUCTO, CON LA EXCEPCION DE QUE CUALQUIER SOFTWARE CONTENIDO O EMPACADO CON ESTE PRODUCTO QUEDA EXCLUIDO DE ESTA GARANTIA Y EN SU LUGAR DEBERA SER CUBIERTO POR LA GARANTIA, SI LA HUBIERA, OFRECIDA EN EL ACUERDO DE LICENCIA DE USUARIO DE SHURE QUE ACOMPAÑE A TAL SOFTWARE.

Service Centers

United States, Canada, Latin America, Carriibbean
Shure Incorporated
Attn: Service Department
5800 W. Touhy Avenue
Niles, IL 60714-4608 U.S.A.

Europe, Middle East, and Africa
Shure Europe GmbH
Attn: Service
Jakob-Dieffenbacher-Str. 12
74078 Eppingen, Germany

Asia
Shure Asia Limited
Attn: Service
22/F, 625 King's Road
North Point, Island East
Hong Kong

BEGRENZTE GARANTIE

Shure Incorporated („Shure“) garantiert hiermit dem Einzelhandels-Erstkäufer nur, sofern im Folgenden nichts anderes angegeben ist, dass dieses Produkt für einen Zeitraum von zwei (2) Jahren ab dem ursprünglichen Datum des vom Verbraucher vollzogenen Kaufs direkt von Shure oder von einem Shure-Vertragshändler bei normalem Gebrauch keine Material- und Herstellungsfehler aufweist.

Die Garantiefrist für jegliche wiederaufladbaren Batterien, die in diesem Produkt enthalten oder damit verpackt sind, beträgt ein (1) Jahr ab dem ursprünglichen Datum des vom Verbraucher vollzogenen Kaufs. Wiederaufladbare Batterien sind allerdings Verbrauchsgüter und ihre Kapazität verringert sich im Laufe der Zeit je nach Umgebungstemperatur, Aufbewahrungszeitraum, Anzahl der Ladezyklen und anderen Faktoren; eine Verringerung der Batteriekapazität stellt deshalb keinen Material- oder Herstellungsfehler dar.

Nach unserem eigenen Ermessen wird Shure ein schadhafes Produkt reparieren oder umtauschen und Ihnen umgehend zurücksenden. Die Gültigkeit der Gewährleistung setzt voraus, dass der Verbraucher zum Zeitpunkt der Produktrücksendung einen Kaufnachweis in Form des Originalkaufbelegs direkt von Shure oder von einem Shure-Vertragshändler vorlegt. Falls sich Shure dazu entschließt, das defekte Produkt zu ersetzen, behält sich Shure nach eigenem Ermessen das Recht vor, das defekte Produkt durch ein anderes Produkt desselben Modells oder durch ein Modell, das mindestens vergleichbare Qualität und technische Eigenschaften aufweist, zu ersetzen.

Falls sich das Produkt innerhalb der Garantie als schadhaft erweist, das Gerät wieder sorgfältig verpacken, versichern und portofrei mit Kaufbeleg an Shure Incorporated, Attention: Service Department (siehe nachfolgende Adresse) zurücksenden.

Für Kundendienst in Deutschland kontaktieren Sie Ihren Händler oder senden das Produkt an:

Shure Europe GmbH
Service
Jakob-Dieffenbacher-Str. 12.
74078 Eppingen, Germany

Für Kundendienst in anderen Regionen / Ländern das Produkt bitte an Ihre jeweils zuständige Vertriebszentrale einsenden. Die Adressen sind im Internet unter www.Shure.com aufgeführt, oder können über die unten aufgeführten Adressen von Shure bezogen werden.

Diese Garantie ist nicht übertragbar. Diese Garantie gilt nicht bei unsachgemäßer Verwendung oder Zweckentfremdung des Produkts, bei Einsatz entgegen den Anweisungen von Shure, bei normalem Verschleiß, bei Schäden durch höhere Gewalt, bei nachlässiger Verwendung, bei Kauf von Dritten außer Shure oder einem Shure-Vertragshändler, bei nicht genehmigter Reparatur oder bei Modifizierung des Produkts.

ALLE STILLSCHWEIGENDEN GARANTIEEN DER HANDELSÜBLICHEN QUALITÄT ODER EIGNUNG FÜR EINEN BESTIMMTEN ZWECK WERDEN HIERMIT IN DEM MASSE AUSGESCHLOSSEN, IN DEM DIE GELTENDEN GESETZE DIES ZULASSEN, UND SO WEIT SIE ES NICHT ZULASSEN, WERDEN DIESE GARANTIEEN DURCH DIE DAUER UND BEDINGUNGEN DIESER GARANTIE EINGESCHRÄNKT. SHURE SCHLIESST HIERMIT AUCH JEDLICHE HAFTUNG FÜR ZUFÄLLIGE, BESONDERE ODER FOLGESCHÄDEN AUS.

Einige Staaten gestatten die Einschränkung des Zeitraums für stillschweigende Garantien nicht; die Einschränkung bzw. der Ausschluss der zufälligen oder Folgeschäden trifft daher auf Sie u. U. nicht zu. Diese Garantie gibt Ihnen bestimmte Rechtsmittel; je nach Gesetzeslage können Sie auch noch andere Rechte haben.

Diese Garantie schränkt die unter den anwendbaren Gesetzen geltenden Rechte des Verbrauchers nicht ein.

DIESE GARANTIE ERSETZT ALLE ANDEREN GARANTIEEN, DIE SICH AUF DIESES PRODUKT BEZIEHEN ODER IN DER PACKUNG ENTHALTEN SIND, AUSSER DER IN DIESEM PRODUKT ENTHALTENEN ODER DAMIT VERPACKTEN SOFTWARE, DIE VON DIESER GARANTIE AUSGENOMMEN IST UND GEGEBENENFALLS

GARANZIA LIMITATA

La Shure Incorporated ("Shure") garantisce al solo acquirente originario del prodotto che, se non diversamente specificato di seguito ed in condizioni di uso regolare, il prodotto sarà esente da difetti di materiali e manodopera per un periodo di due (2) anni a decorrere dalla data del primo acquisto avvenuto direttamente presso Shure o presso un rivenditore autorizzato.

Le batterie ricaricabili contenute nel prodotto o ad esso a corredo vengono garantite per un periodo di un (1) anno a decorrere dalla data del primo acquisto. Tuttavia, le batterie ricaricabili sono materiali di consumo la cui capacità si riduce nel tempo in relazione a temperatura, durata di stoccaggio, cicli di carica ed altri fattori; quindi, la riduzione della capacità delle batterie non rappresenta un difetto di materiale o manodopera.

A propria ed esclusiva discrezione, Shure provvederà a riparare o sostituire il prodotto difettoso e ve lo restituirà in tempi brevi. Ai fini della validità della presente garanzia, al momento della restituzione del prodotto, l'acquirente è tenuto a presentare lo scontrino originale, emesso da Shure o da un rivenditore autorizzato, comprovante l'acquisto. In caso di sostituzione del prodotto difettoso, Shure si riserva il diritto di effettuare tale sostituzione con un altro prodotto dello stesso modello o altro modello avente caratteristiche e qualità almeno comparabili ad insindacabile giudizio di Shure stessa.

Se ritenete che questo prodotto sia difettoso, durante il periodo di garanzia, imballatelo accuratamente e speditelo assicurato e franco destinatario, unitamente allo scontrino, all'indirizzo indicato in fondo alla pagina.

Fuori degli USA, consegnate il prodotto al rivenditore o ad un centro di assistenza autorizzato. Gli indirizzi dei rivenditori sono consultabili sul sito Internet www.Shure.com oppure possono essere richiesti direttamente a Shure contattandola all'indirizzo indicato.

La presente garanzia non è trasferibile. Inoltre, non si applica in caso di abuso o uso improprio del prodotto, uso contrario alle istruzioni Shure, usura ordinaria, danni di forza maggiore, negligenza, acquisto da terzi diversi da Shure o rivenditori autorizzati Shure, riparazioni non autorizzate o modifiche al prodotto.

QUALSIASI GARANZIA DI COMMERCIALITÀ O IDONEITÀ AD UNO SCOPO SPECIFICO VIENE DECLINATA DA SHURE NELLA MISURA CONSENTITA DALLA LEGISLAZIONE VIGENTE E, LADDOVE TALE LEGISLAZIONE NON CONSENTA DECLINAZIONE ALCUNA, VIENE LIMITATA ALLA DURATA ED ALLE CONDIZIONI DELLA PRESENTE GARANZIA. SHURE SI RITIENE, INOLTRE, ESENTE DA RESPONSABILITÀ DI DANNI CASUALI, SPECIALI O INDIRETTI.

Poiché la legge potrebbe non permettere limitazioni sul periodo di validità di una garanzia implicita, o l'esclusione o la limitazione di danni casuali o indiretti, la suddetta limitazione potrebbe non riguardarvi. Questa garanzia fornisce specifici diritti legali, che possono variare a seconda dei vari Stati/Paesi.

Questa garanzia non limita i diritti dell'acquirente istituiti dalla legislazione vigente.

QUESTA GARANZIA ANNULLA QUALSIASI ALTRA GARANZIA RELATIVA O ACCLUSA A QUESTO PRODOTTO, A MENO CHE L'EVENTUALE SOFTWARE CONTENUTO IN QUESTO PRODOTTO O AD ESSO ALLEGATO SIA ESCLUSO DA QUESTA GARANZIA E VENGA INVECE COPERTO DALLA GARANZIA, SE PRESENTE, FORNITA NELLA LICENZA DELL'UTENTE FINALE SHURE IN DOTAZIONE A TALE SOFTWARE.

Service Centers

United States, Canada, Latin America, Caribbean
Shure Incorporated
Attn: Service Department
5800 W. Touhy Avenue
Niles, IL 60714-4608 U.S.A.

Europe, Middle East, and Africa
Shure Europe GmbH
Attn: Service
Jakob-Dieffenbacher-Str. 12
74078 Eppingen, Germany

Asia
Shure Asia Limited
Attn: Service
22/F, 625 King's Road
North Point, Island East
Hong Kong

제한 보증

Shure Incorporated(“Shure”)는 아래에 기술한 예외를 제외하고, 제품을 최초로 구입한 소비자에게 본 제품을 정상적인 용도로 사용하는 경우에 대해 Shure로부터 또는 Shure 공식 대리점으로부터 직접 구입한 일로부터 2년 동안 사용 자재 및 제작기술 측면에서 제품에 하자가 없음을 보증합니다.

본 제품 내에 포함되어 있거나 함께 포장된 모든 충전용 건전지는 소비자가 최초로 구입한 날로부터 1년 간 보증됩니다. 하지만, 충전용 건전지는 소모품이고 온도, 보관기간, 충전 주기 및 기타 요인에 의해 그 용량이 감소하기 때문에, 용량의 감소는 재료 또는 제작기술의 결함으로 간주되지 않습니다.

Shure는 자체 결정에 따라 결함이 있는 제품을 수리 또는 교환하여 사용자에게 신속하게 돌려 드립니다. 이 보증의 효력을 유지하려면, 소비자는 반드시 제품을 돌려받는 시점에, Shure 또는 Shure 공식 대리점으로부터 직접 발급받은 최초 구입 영수증을 구입 증빙자료로 제공해야 합니다. Shure가 불량품을 교체하기로 결정한 경우에는, Shure는 불량품을 동일 모델의 다른 제품 또는 Shure가 최소한 대등한 기능과 품질을 제공한다고 판단한 별도 모델의 제품으로 교체할 권리를 보유합니다.

보증 기간 내에 본 제품에 하자가 있다고 판단하는 경우, 기기를 조심스럽게 다시 포장하여, 보험에 들고 제품 구입 증빙과 함께 반환용 우편 요금을 미리 지불한 후 Shure Incorporated의 다음 부서로 반송하십시오: 서비스 부서, 주소는 하기 참조.

미국 이외의 지역에서는, 그 지역의 대리점 또는 공인 서비스 센터로 제품을 보내십시오. 반송 주소는 www.Shure.com의 목록을 참조하거나 하기 주소로 Shure 에 연락하여 문의하기 바랍니다.

이 보증은 제3자에게 양도할 수 없습니다. 이 보증은 제품을 규정외의 용도에 사용하거나 사용방법이 잘못된 경우, Shure가 제공한 지침을 무시하거나, 사용누적에 따른 일반적인 성능 열화, 천재지변, 부주의한 사용, Shure 또는 Shure 공식 대리점을 통하지 않은 제품 구입, 제품을 무단 수리 또는 개조한 경우에는 적용되지 않습니다.

관련법에 의해 허용되는 범위 내에서, 상품성 또는 특정 용도에 대한 적합성에 관해 명백하게 표현된 바 없는 일체의 보증은 이에 인정되지 아니하며, 단 관련법에 의해 이것이 허용되지 않는 경우에는 이 보증서의 유효기간 및 보증 조건의 제한을 받습니다. SHURE는 또한 일체의 우발적, 특정적, 또는 인과적 손상에 대한 일체의 책임을 인정하지 않습니다.

일부 주에서는 암묵적 보증의 지속 기간에 대한 제한이나, 우연적이거나 필연적인 손해의 배제 또는 제한을 허용하지 않으므로, 위 제한 문구는 귀하에게 적용되지 않을 수도 있습니다. 본 보증은 귀하에게 구체적 법적 권리를 부여하며, 귀하는 주에 따라 다른 여타의 권리를 가질 수도 있습니다.

본 보증은 적용되는 법률에 의해 명령된 소비자의 권리를 제한하지 않습니다.

본 보증은 본 제품과 연계되거나 포함된 모든 다른 종류의 보증을 대체합니다. 단, 본 제품에 포함되거나 함께 포장된 임의의 소프트웨어가 본 보증의 적용을 받지 않고 그 대신 해당 소프트웨어에 등반된 Shure 의 사용자 라이선스 계약에서 제공된 보증의 적용을 받는 경우에는 예외로 합니다.

有限保修

Shure Incorporated (“Shure”)特此向原始消费购买者保证 (除非下文另说明), 自消费者直接从 Shure 或 Shure 授权的经销商初次购买本产品之日起两 (2) 年内, 本产品在正常方法的使用中不会有材料和工艺上的缺陷。

本产品附带的任何充电电池, 保修期为自消费者初次购买之日起的一 (1) 年。但是, 充电电池为消耗性部件, 它在使用过程中会受到温度、存放时间、冲放电次数以及其它因素的影响, 电池容量可能会降低; 这种电池容量的降低不是材料或工艺上的缺陷。

Shure 将自行决定修理或更换有缺陷的产品, 并及时返还给您。为使本保修生效, 消费者必须在产品退还之时提供直接从 Shure 或 Shure 授权的经销商处取得的原始购买收据作为购买凭证。如果 Shure 选择更换不合格的产品, Shure 有权自行决定用同型号的另一件产品或质量和性能大体相符的型号替换有缺陷的产品。

如果您认为本产品在本保修期内出现故障, 请将其仔细地重新包装, 办好保险, 预付邮资后, 连同购买凭证一起退给 Shure 公司, 收件人: Service Department, 地址见下文。

美国境外的消费者, 应将产品退回给您的经销商或授权服务中心。网站 www.Shure.com 列出了地址, 或可按以下地址与 Shure 联系, 索取退回地址。

此保修不可转让。本保修不适用于下列情况: 对产品的滥用或使用不当、未按照 Shure 的指导使用产品、正常磨损、天灾、使用中的疏忽、并非从 Shure 或 Shure 授权的经销商处购买的产品、未经授权修理或更改后的产品。

在适用法律允许的范围内, 谨在此明确排除针对某一特定用途或目的的适销性或适用性的任何暗示保证, 而若法律不允许, 则限制在本保修的有效期和条款范围内。Shure 还在此排除对偶然、特殊或间接损害赔偿的全部责任。

一些州不允许对默示保证的期限设定限制条款, 或排除或限制间接或后果性损害赔偿, 因此上述限制条款可能不适用于您。本保修给予您特定的法律权利, 并且您还可以拥有其它权利, 这些权利在州与州之间不尽相同。

本保修不限制适用法律所赋予消费者的各项权利。

本保修替代与本产品相关的或包括的所有其它保修, 但本产品包含的或与本产品合装的任何软件不在本保修范围内, 而应在此等软件附带的 Shure 最终用户许可协议中的保修条款的范围内。

Service Centers

United States, Canada, Latin America, Caribbean
Shure Incorporated
Attn: Service Department
5800 W. Touhy Avenue
Niles, IL 60714-4608 U.S.A.

Europe, Middle East, and Africa
Shure Europe GmbH
Attn: Service
Jakob-Diefenbacher-Str. 12
74078 Eppingen, Germany

Asia
Shure Asia Limited
Attn: Service
22/F, 625 King's Road
North Point, Island East
Hong Kong

限定保証

Shure Incorporated (「Shure」)は、下記に記載された場合を除き、最初に購入した消費者に対し、本製品が通常の使用において材質・製造ともに欠陥がないことを、ShureまたはShure認定再販業者から消費者が直接購入した最初の購入日から2年間にわたり保証いたします。

本製品に含まれる、または同梱されている充電式バッテリーは、消費者の最初の購入日から1年間保証されます。ただし、充電式バッテリーは消耗品であり、温度、保管期間、充電間隔等の要因により容量が減少していきます。したがって、バッテリー容量の低下は材質または製造の欠陥には含まれません。

Shureでは、自らの判断により、欠陥製品を修理または交換して速やかに返送いたします。本保証を有効にするには、製品返品時にShureまたはShure認可再販業者が直接発行した購入領収書の実物を、購入証明書として提出する必要があります。Shureが欠陥製品を交換する場合は、Shureの独自の判断により、欠陥製品を、同モデルの製品または少なくとも品質と機能が適合するモデルの製品と交換いたします。

保証期間中、本製品に欠陥があると思われる場合は、製品を注意して梱包し、購入証明書を同封し、保険をかけて郵便料金前払いにて以下の住所のShure IncorporatedのService Department宛にご返送ください。

米国外にお住まいの場合は、販売店または認可サービスセンターまで製品をお持ちください。住所のリストはwww.Shure.comでご覧になるか、以下の住所のShureまでお問い合わせください。

本保証は譲渡できません。本保証は、本製品の濫用や誤用、Shureの使用説明書に反する使用、自然の消耗や摩耗、天災、過失による使用、ShureまたはShure認定再販業者以外からの購入、非認可の修理、製品の改造の場合には適用されません。

商品性または特定目的の適合性などの黙示保証は、該当する法律が許す範囲ですべて放棄され、法律が許さない範囲では本保証の期間および条件に限定されます。Shureはまた、付随的損害または特別損害、間接的損害については一切の責任を負いません。

黙示保証期間の制限または付随的損害もしくは間接的損害の除外や制限を認めていない州がありますので、上記の保証制限はお客様には適用されない場合があります。本保証によりお客様は特定の法的権利を付与されますが、州によって異なる他の権利を持つ場合があります。

本保証は準拠法の下で義務付けられた消費者の権利を制限するものではありません。

本保証は本製品に関連するまたは含まれるその他すべての保証に優先するものとします。ただし、本製品に含まれるまたは同梱されているソフトウェアは、本保証の対象外であり、当該ソフトウェアに伴うSHURE社のエンドユーザーライセンス合意内容が適用されます。

GARANSI TERBATAS

Shure Incorporated (「Shure」) dengan ini memberikan garansi kepada pembeli atau konsumen dari produk Shure bahwa hanya produk ini yang akan bebas dari pemakaian normal terhadap cacat-cacat dalam pembuatan selama jangka waktu 2 (dua) tahun dari tanggal pembelian semula oleh konsumen langsung dari Shure atau dari agen resmi Shure.

Semua baterai isi ulang yang terdapat di dalam dan dikemas dengan produk ini juga mendapat garansi selama satu (1) tahun sejak tanggal pembelian semula. Namun, baterai isi ulang bisa habis masa pakainya dan kapasitasnya akan berkurang dari waktu ke waktu yang disebabkan oleh suhu, lama penyimpanan, siklus pengisian daya, dan faktor lain; oleh karenanya berkurangnya kapasitas baterai ini tidak termasuk cacat dalam pembuatan.

Dengan opsi tunggalnya, Shure bersedia untuk memperbaiki atau mengganti produk yang cacat dan segera mengirimkan ke alamat Anda. Agar garansi ini berlaku, pada saat produk ini dikembalikan, konsumen harus memberikan tanda bukti pembelian dalam bentuk kuitansi asli pembelian langsung dari Shure atau dari agen resmi Shure. Seandainya Shure memilih untuk mengganti produk yang cacat, maka Shure berhak untuk mengganti produk yang cacat itu dengan produk lain dari model yang sama atau model yang sedikit-tidaknya dengan kualitas dan fitur yang setara dengan penentuan tunggal oleh Shure.

Jika Anda yakin produk ini cacat dalam jangka waktu garansi, silakan kemas kembali unit produk tersebut dengan hati-hati, pastikan dan kirim kembali bersama bukti pembelian, melalui pos, kepada Shure Incorporated, U.p.: Service Department, pada alamat di bawah ini. Service Department, pada alamat di bawah ini.

Di luar Amerika Serikat, silakan kirim kembali produk tersebut ke agen Anda atau Pusat Servis Resmi. Alamat dicantumkan di www.Shure.com atau dapat diperoleh dengan menghubungi Shure di alamat yang tercantum berikut.

Garansi ini tidak dapat dipindahkan. Garansi ini tidak berlaku jika kerusakan produk tersebut disebabkan oleh penyalahgunaan atau kesalahan tata cara pemakaian, pemakaian yang bertentangan dengan petunjuk Shure, aus normal, bencana alam, kelalaian pemakaian, dibeli dari pihak lain selain dari Shure atau agen resmi Shure, perbaikan yang dilakukan bukan di dealer resmi, atau produk tersebut telah dimodifikasi.

SEMUA GARANSI YANG TERMASUK DARI YANG DAPAT DIJUAL-BELIKAN ATAU PUN KEMAMPUAN UNTUK MAKSUD TERTENTU DENGAN INI DITOLAK PADA TINGKAT YANG DIBOLEHKAN BERDASARKAN UNDANG-UNDANG YANG BERLAKU DAN, PADA TINGKAT YANG TIDAK DIBOLEHKAN, DENGAN INI DIBATASI PADA LAMANYA DAN JANGKA WAKTU GARANSI INI. SHURE JUGA DENGAN INI MENOLAK SEMUA KEWAJIBAN DARI KERUSAKAN YANG BERSIFAT KEBETULAN, KHUSUS MAUPUN KERUSAKAN YANG DIAKIBATKANNYA.

Beberapa negara tidak mengizinkan pembatasan pada berapa lama garansi tersebut berlangsung, atau larangan maupun pembatasan terhadap kerusakan yang bersifat kebetulan atau yang ditimbulkan, maka pembatasan di atas tidak bisa berlaku pada Anda. Garansi ini memberikan Anda hak hukum khusus, dan Anda mungkin memiliki hak lain yang berbeda dari setiap negara.

Garansi ini tidak membatasi hak-hak konsumen yang diharuskan menurut undang-undang yang berlaku.

GARANSI INI MENGGANTIKAN SEMUA GARANSI LAINNYA YANG TERKAIT DENGAN ATAU YANG TERMASUK DALAM PRODUK INI, KECUALI PERANGKAT LUNAK YANG TERDAPAT DALAM DAN DIKEMAS DENGAN PRODUK INI TIDAK TERCAKUP DALAM GARANSI INI DAN SEBALIKNYA AKAN DICAKUP OLEH GARANSI, JIKA ADA, YANG DIBERIKAN DALAM PERNYATAAN LISENSI PENGGUNA AKHIR SHURE YANG MENYERTAI PERANGKAT LUNAK TERSEBUT.

United States, Canada, Latin America, Carribean
Shure Incorporated
Attn: Service Department
5800 W. Touhy Avenue
Niles, IL 60714-4608 U.S.A.

Europe, Middle East, and Africa
Shure Europe GmbH
Attn: Service
Jakob-Dieffenbacher-Str. 12
74078 Eppingen, Germany

Asia
Shure Asia Limited
Attn: Service
22/F, 625 King's Road
North Point, Island East
Hong Kong

Service Center Resmi:
Jakarta Hotline (021) 612 6286
Medan (061) 6612550
Surabaya (031) 5032219
Jogjakarta (0274) 371710
Denpasar (0361) 766788
Makasar (0411) 324652

SHURE[®]
LEGENDARY
PERFORMANCE™

**United States, Canada, Latin
America, Caribbean:**

Shure Incorporated
5800 West Touhy Avenue
Niles, IL 60714-4608 USA

Phone: 847-600-2000
Fax: 847-600-1212 (USA)
Fax: 847-600-6446
Email: info@shure.com

Europe, Middle East, Africa:

Shure Europe GmbH
Jakob-Dieffenbacher-Str. 12,
75031 Eppingen, Germany

Phone: 49-7262-92490
Fax: 49-7262-9249114
Email: info@shure.de

Asia, Pacific:

Shure Asia Limited
22/F, 625 King's Road
North Point, Island East
Hong Kong

Phone: 852-2893-4290
Fax: 852-2893-4055
Email: info@shure.com.hk

PT. GOSHEN SWARA INDONESIA

Kompleks Harco Mangga Dua Blok L No. 35 Jakarta Pusat

I.16.GSI31.00501.0211