

DDS 5900 Digital Discussion System

The DDS 5900 Digital Discussion System is a conferencing solution with plug-and-play setup and online discussion management. With excellent audio quality and programmable touch-button controls, compact microphone units facilitate clear communication in large groups and meeting spaces. The system manages up to eight talkers at a time and dedicates two channels for interpretation, supporting bilingual events without additional equipment.

The DDS 5900 Digital Discussion System is comprised of one central unit, the control browser, and discussion units for up to 250 participants. Supporting multiple user types, a gooseneck microphone, loudspeaker, and control buttons are combined in a compact discussion unit. With highly flexible layout options and a choice of tabletop or flushmount units, the system seamlessly integrates into a wide range of professional environments, such as:

- Corporate meeting rooms
- City councils and regional government bodies
- Educational institutions
- Courtrooms
- Videoconferencing rooms



Features

<p>Clear, Natural Communication</p>	<p>DDS 5900 discussion units enhance group communication, allowing natural conversation to be heard in large meeting spaces. Gooseneck microphones provide excellent speech isolation, while the LED light ring indicates who is talking. A 24-bit digital audio signal is transported to each discussion unit for real-time monitoring from the loudspeaker. Several microphone operation modes provide manual and automatic microphone activations.</p>
<p>Sleek, Professional Design</p>	<p>Modern, low-profile design integrates into a variety of spaces, from historic buildings to contemporary boardrooms. DDS 5900 discussion units are intuitive and functional, reducing clutter and increasing tabletop workspace. Two model variations are available to support the needs of any event:</p> <ul style="list-style-type: none"> • Compact flushmount unit for permanent installation • Portable unit for quick setup and easy removal
<p>Flexible Setup and Easy Installation</p>	<p>The DDS 5900 system uses a proprietary protocol to transport digital audio, control data, and power over the same cable (shielded Cat5e). The system supports large events of up to 250 participants, easily scaling with additional components added inline for a simplified layout topology.</p>
<p>Remote Management</p>	<p>For comprehensive system management, open the browser-based control app using a computer or tablet. The interface adds system configuration and discussion setup capabilities, enabling an administrator to prepare the discussion with participant names and seat numbers. The chairman or moderator uses a dedicated page for speaker management during the discussion. The system is also compatible with Crestron, AMX, and other control systems. The CCU easily interconnects with teleconferencing equipment and external audio components.</p>

System Concepts

The DDS 5900 Discussion system is an important communication tool for meetings of any size. Participants use the discussion unit microphone and loudspeaker to communicate using natural speech levels.

The Discussion Unit: A Personal Sound System

The DDS 5900 Discussion System improves communication amongst a group of people by combining the microphone, loudspeaker, interpretation audio, and user controls in an integrated unit. When a participant speaks, their voice is heard at the other units' loudspeakers. The DDS 5900 is a perfect solution when every participant is both a talker and a listener.

In contrast, traditional sound systems support the communication of one or two speakers to a crowd of people. In those systems, it is impossible to have the dialog required in a discussion setting.

Discussion Participants and Roles

The DDS 5900 discussion unit is programmable to support different functions required by different people involved in the discussion. For example, as the moderator of the discussion, the chairman has an extra control that immediately turns off all delegate microphones. In a typical event, there are three categories of participants:

The following is an overview of each participant role and how they function in a typical discussion.

<p>Delegate (member, participant)</p>	<p>The majority of participants fall into this category. The delegate role is for anyone involved in the discussion that is not a chairman or interpreter. Delegates use the discussion unit to speak and listen to other participants. Depending on the discussion settings, the delegate may send a request to speak before the microphone is activated by the Chair.</p> <ul style="list-style-type: none"> • Up to 250 participants are supported in the DDS 5900 system.
<p>Chairman (chair, moderator, president)</p>	<p>The chairman, or simply the Chair, is the moderator of the discussion. Typically seated at the head of the meeting space, the Chair has the ultimate authority over who is speaking. Using the browser interface, the moderator has ability to turn microphones on or off for specific participants, and view the order in which participants request to speak. Providing immediate control of the discussion, an 'all-delegates off' button is available on discussion units programmed to chairman mode.</p> <ul style="list-style-type: none"> • There is typically only one chairman for each event, though more can be added.
<p>Interpreter</p>	<p>When an additional language is spoken in a discussion, an interpreter provides simultaneous interpretation using the discussion unit. Interpreters select from one of two channels to transmit to other participants speaking the same language. This system supports bilingual, two-way discussion, facilitating the back-and-forth communication between delegates speaking two different languages.</p> <ul style="list-style-type: none"> • The system supports simultaneous interpretation for two languages

Component Overview

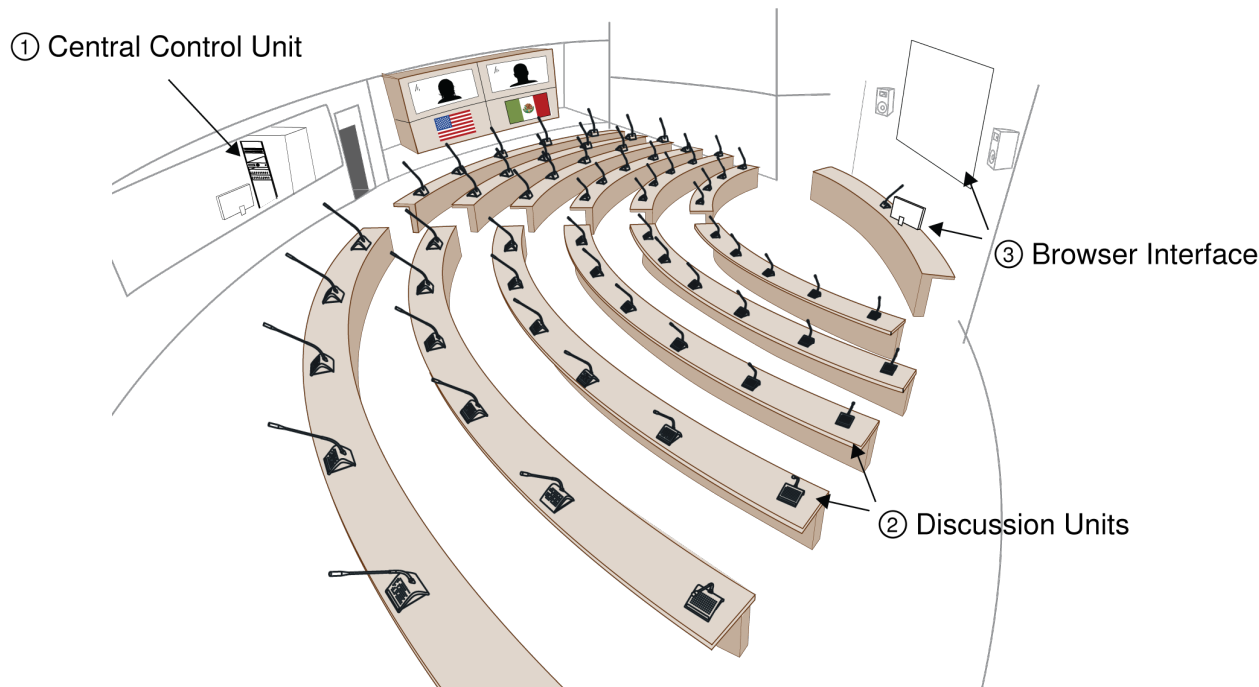

The DDS 5900 Discussion System consists of the following components:

<p>① DIS-CCU Central Control Unit</p>	<p>The central control unit (CCU) is the processor for the DDS 5900 system. It provides power and control to the discussion units, analog audio inputs and outputs for external equipment, and a web server that hosts the browser interface for remote system control. Each system uses a single CCU.</p>					
<p>② Discussion Units</p>	<p>Participants use the discussion units (DU) to speak and listen to other members of the event. A microphone, loudspeaker, and channel selector are provided for each unit. Units connect in series, simplifying setup by transporting power, audio, and control data on the same cable. There are two models of discussion units:</p> <table border="1" data-bbox="475 1377 1500 1724"> <tr> <td data-bbox="475 1377 732 1528"> <p>DC 5980 P Portable Discussion Unit</p> </td> <td data-bbox="732 1377 1500 1528"> <p>All-in-one unit that sits on the table surface. It is configurable as chairman, delegate, or interpreter.</p> </td> </tr> <tr> <td data-bbox="475 1528 732 1724"> <p>DC 5900 F Flushmount Discussion Unit</p> </td> <td data-bbox="732 1528 1500 1724"> <p>The flushmount discussion unit installs unobtrusively into a table or podium. The modular unit adds functionality depending on the components. It is configurable as chairman or delegate.</p> </td> </tr> </table>		<p>DC 5980 P Portable Discussion Unit</p>	<p>All-in-one unit that sits on the table surface. It is configurable as chairman, delegate, or interpreter.</p>	<p>DC 5900 F Flushmount Discussion Unit</p>	<p>The flushmount discussion unit installs unobtrusively into a table or podium. The modular unit adds functionality depending on the components. It is configurable as chairman or delegate.</p>
<p>DC 5980 P Portable Discussion Unit</p>	<p>All-in-one unit that sits on the table surface. It is configurable as chairman, delegate, or interpreter.</p>					
<p>DC 5900 F Flushmount Discussion Unit</p>	<p>The flushmount discussion unit installs unobtrusively into a table or podium. The modular unit adds functionality depending on the components. It is configurable as chairman or delegate.</p>					
<p>③ Browser Interface</p>	<p>The browser interface provides comprehensive setup and discussion management for the DDS 5900 system. It opens in a web browser from a computer networked with the CCU. Use the interface to manage microphones, assign names and seat numbers to delegates, and advanced system configuration.</p>					

Central Control Unit

The DIS-CCU Central Unit provides the intelligence for systems of up to 250 participants in the DDS 5900 system. It processes audio and control signals from each discussion and interpreter unit, and distributes audio to other participants for listening to the discussion.

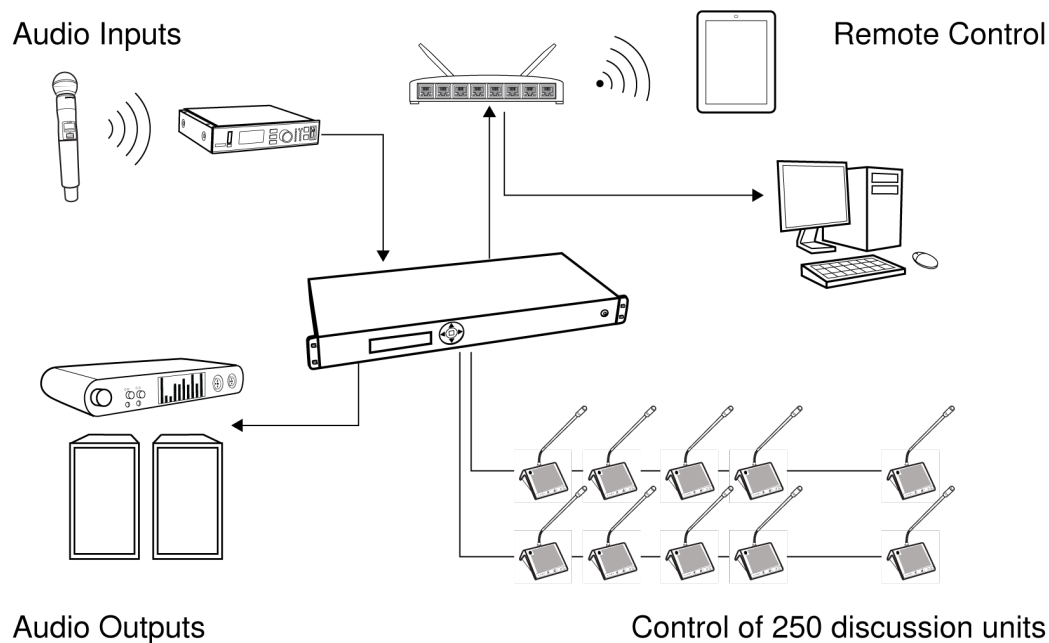

System Hub

The CCU connects external equipment to the DDS 5900 system

When used with the DDS 5900 system, the DIS-CCU has the following features:

- Controls a system of up to 250 discussion units
- Transports secure audio signal with a proprietary codec algorithm
- Provides a web server for advanced control through a browser interface
- Supplies power for up to 50 discussion units
- Supports two (2) interpretation channels for bilingual discussions
- Provides eight (8) audio outputs to send interpretation or group channels to PA systems, audio mixers, audio recorders, or a language distribution system
- Provides two (2) audio inputs for connecting wireless microphones, processed audio signals, an emergency broadcast message (EEM), or music during meeting breaks
- One rack unit (1RU) size installs into a standard 19" rack

DIS-CCU Hardware Description

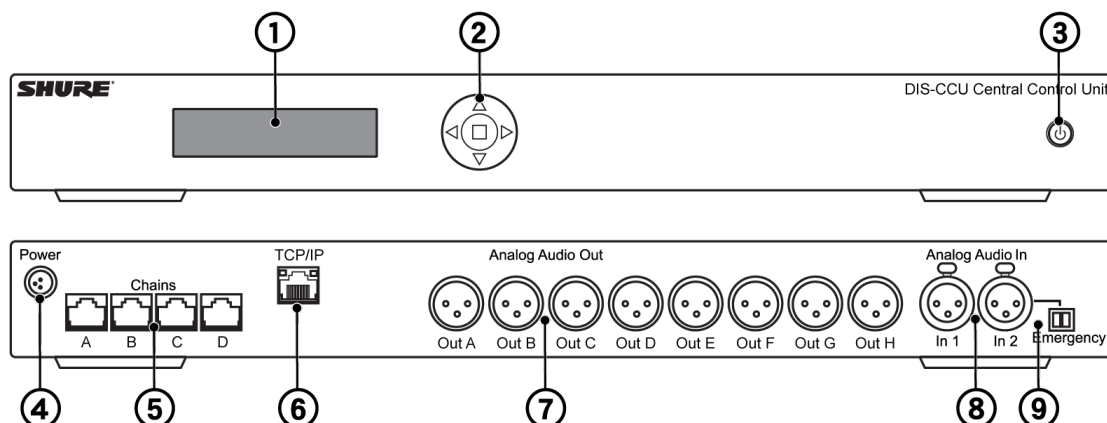

DIS-CCU Central Unit

Front Panel	
① Menu display	A 2x20 character OLED-display enables system configuration without a computer.
② Navigation Buttons	5-button keypad for configuring the system without a computer.
③ Power Button	<p>The power button turns on or off the central unit. All connected DCS-LAN units and power supplies will automatically power on or off with the CCU.</p> <ul style="list-style-type: none"> • Green = powered on • Red = powered off but connected to power supply • Off = no power supply is connected to the CCU <p>Note: System settings are stored and persist through a power cycle.</p>

Back Panel	
④ Power Supply Connector	Threaded connector secures to the PS-CCU power supply.
⑤ DCS-LAN Outputs	<p>Four RJ45 jacks are available for connecting the microphone units, forming the DCS-LAN. The DCS-LAN chain safely carries digital audio, control data, and power over the same cable. Use any or all of the four outputs for a variety of layout configurations.</p> <p>Important: Only connect DCS-LAN equipment to this output.</p>
⑥ Control Connector (TCP/IP)	The RJ45 connector allows access to the built-in web application from a computer, or for connection to a control system like AMX® or Crestron®.

Back Panel	
⑦ Audio Outputs	Eight balanced, male XLR connectors for connection to PA systems, audio mixers, audio recorders, or a language distribution system.
⑧ Audio Inputs	Two balanced, female XLR connector for adding external audio equipment to the meeting, such as wireless microphones, a teleconferencing system, processed audio signals, an emergency broadcast message (EEM), or music during meeting breaks. Input gain and volume are adjust from the CCU front-panel or web application.
⑨ Emergency switch connector	Provides an emergency override signal in the event of an emergency. When the connected switch is closed, the audio signal on Input 2 is distributed to all output channels, overriding all other audio inputs.

Simplified Audio Diagram

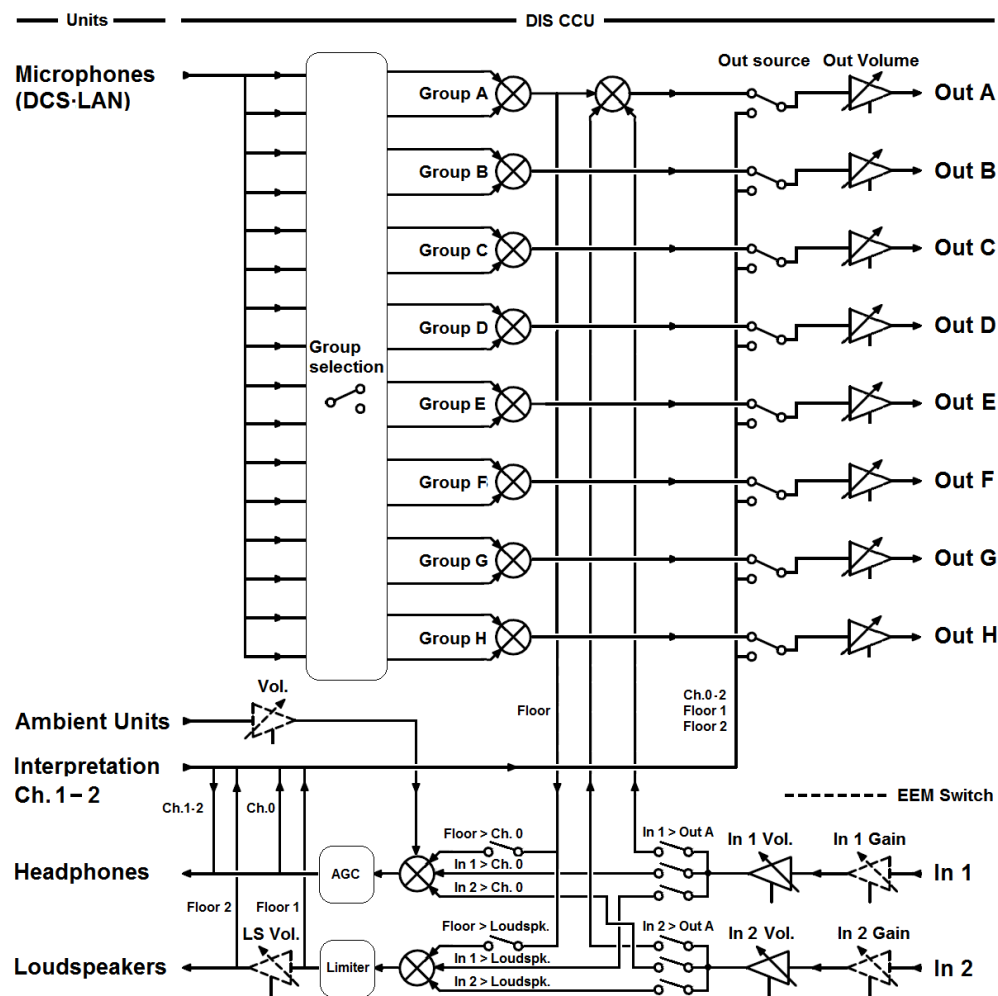

DIS-CCU Audio Diagram

Menu Navigation

The DIS-CCU provides controls from the front panel for system setup and configuration. Use the 5-button keypad to navigate the menu and change settings.

The figure below gives an overview of the menu structure.

- Use arrow buttons to cycle through menu items
- Press enter (center) button to navigate to an editable field.
- Use up/down buttons to cycle through the available values

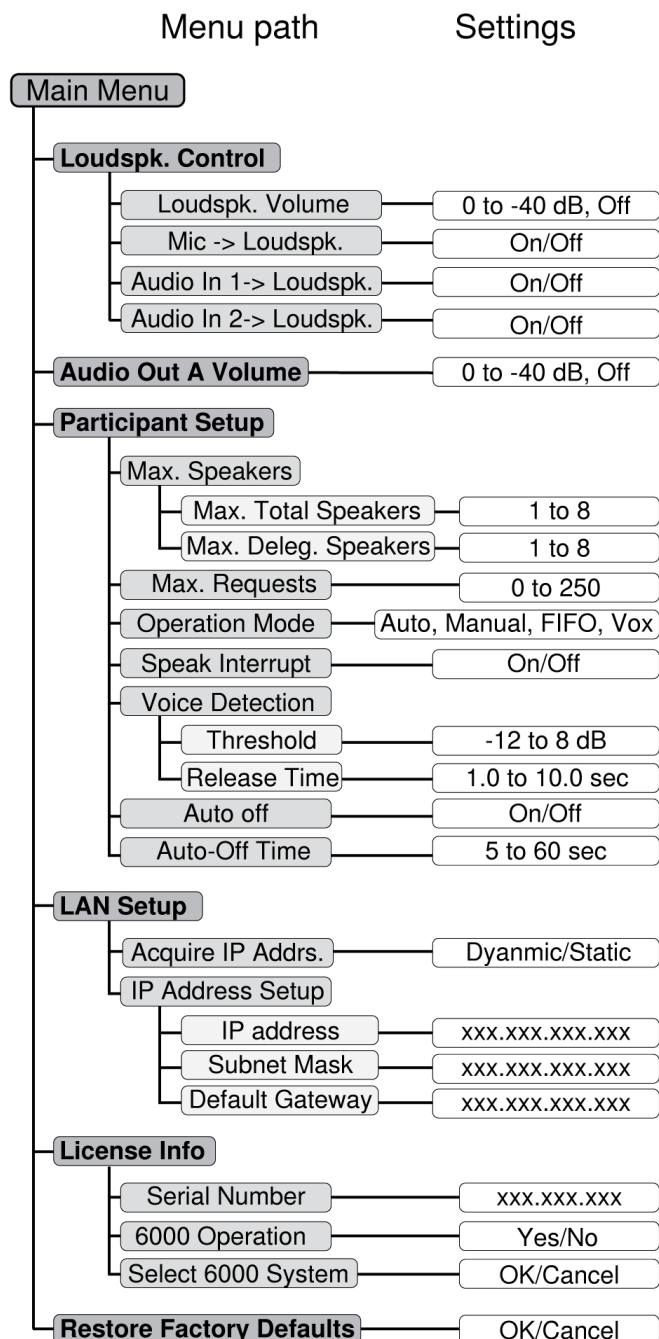

Discussion Units

Participants use discussion units to communicate with other members of the event. Connected in daisy-chain configuration from the central unit, they transport digital audio, control signals, and power over a single cable. The sleek, professional design and minimal cabling allows seamless integration into professional meeting spaces. A DDS 5900 system supports up to 250 discussion units at the same time.

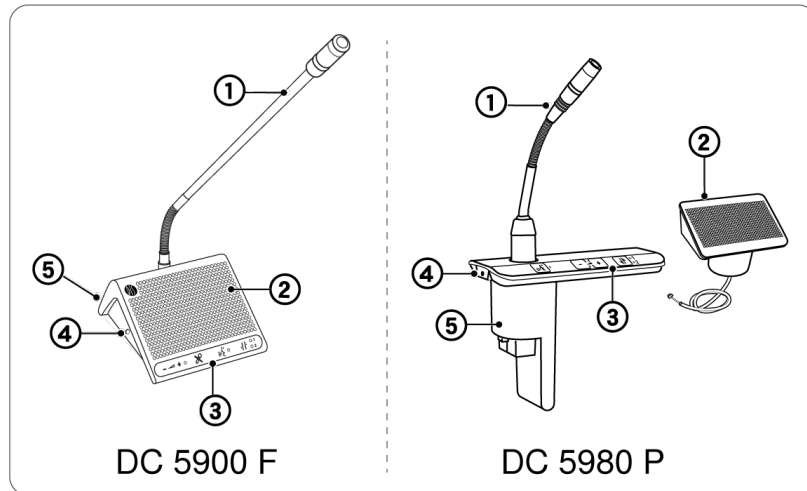

DDS 5900 Discussion Units

Primary functions of the unit:

① Microphone

for speech

② Speaker

for listening to the discussion

③ Control Buttons

for microphone operation and interpretation channel selection

④ Headphone Jack

for listening to an interpretation channel or the floor audio

⑤ Base with RJ-45 Jacks

for power, audio, control transport

Model Variations

DC 5980 P Portable Discussion Unit

Sits on the tabletop without drilling or cutting the surface, and easily dismantles for system reconfiguration. Features include an integrated speaker, rear-exit cable routing, and operation as an chairman, delegate, or interpreter unit.

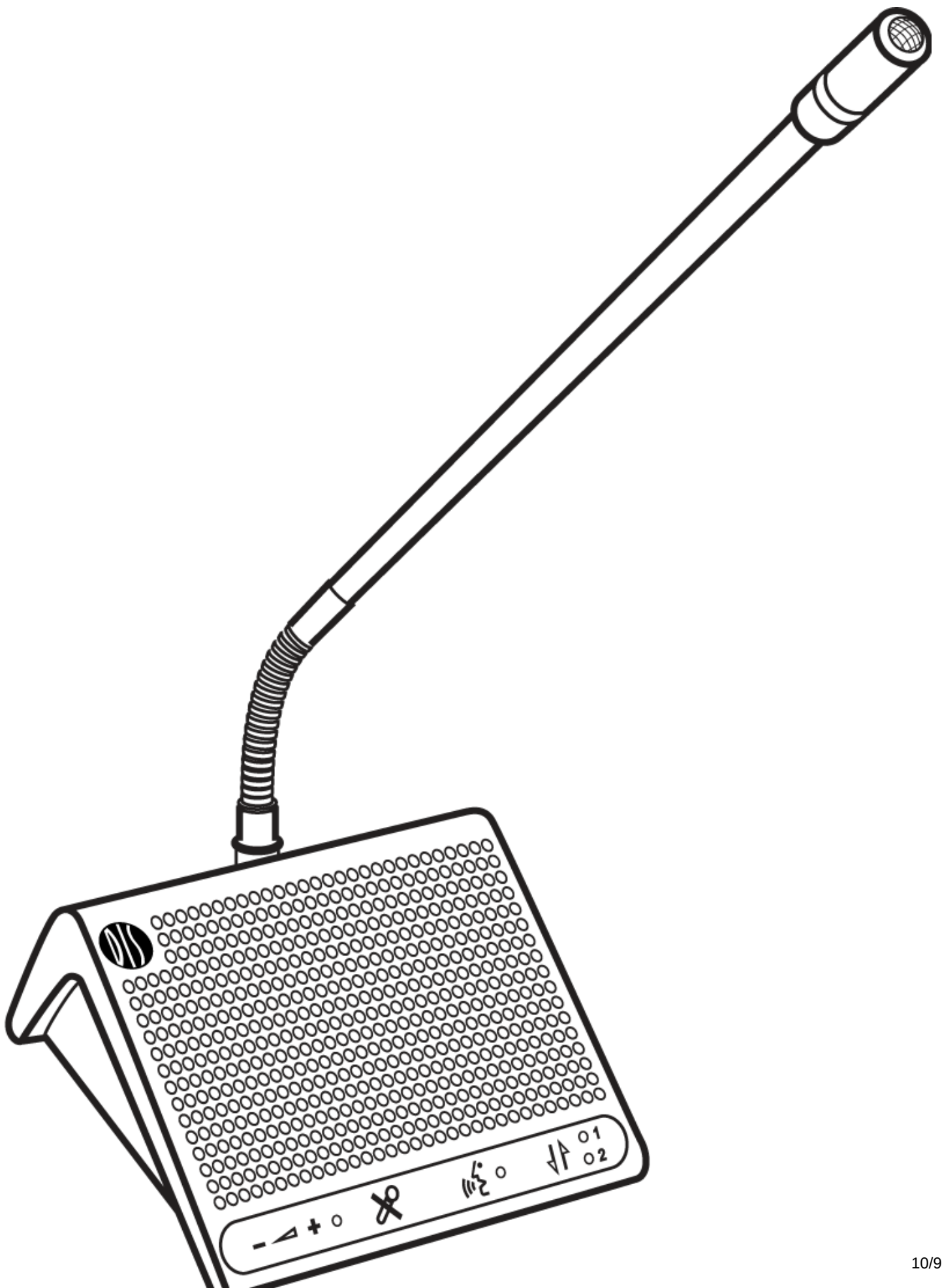

DC 5980 P Portable Discussion Unit

Integrated Design

The following features are integrated in the unit

Interpretation Monitoring

Listen to an interpretation channel using the channel selector and headphone output.

Sound Reinforcement

Loudspeaker for listening to other talkers.

Microphone Variations

Compatible with all DIS microphones.

DC 5900 F Flush-Mounted Discussion Unit

Installs permanently into a table or podium. A low-profile design conceals the base and cabling below the tabletop surface. This unit can operate as a chairman or delegate.

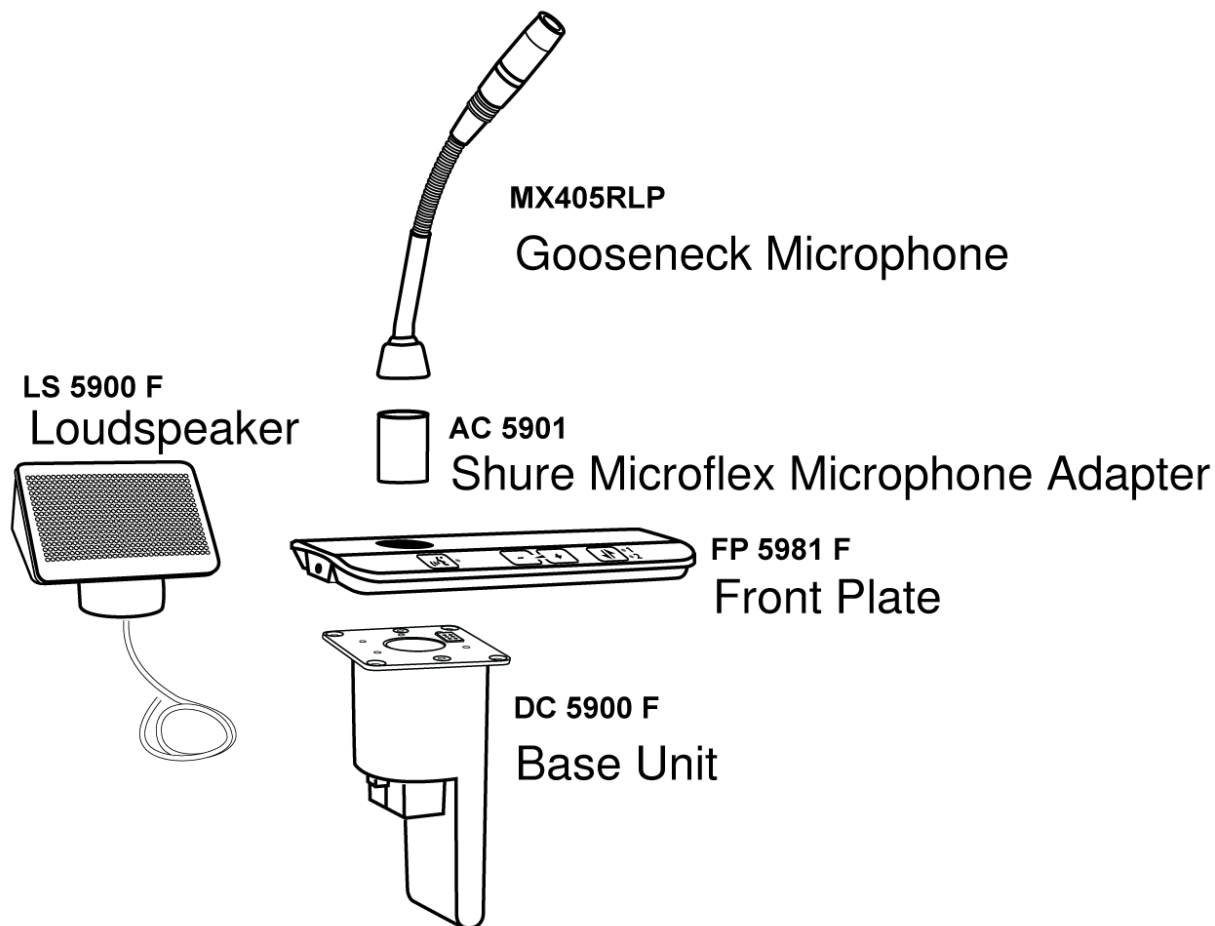

DC 5900 F Discussion Unit

Modular Design

Functionality is scalable by adding or subtracting parts.

Interpretation Monitoring

Two front plate variations are available:

- FP 5981 F: interpretation monitoring is supported with a headphone jack and channel selector
- FP 5921 F: not supported

Sound Reinforcement

Add the optional LS 5900 F loudspeaker for listening to other talkers.

Microphone Variations

In addition to DIS microphones, several Shure Microflex® Gooseneck microphones are compatible with the flush-mount unit by connecting the AC 5901 adapter.

Overlay Control Buttons

The discussion unit is programmable to support different people involved in the discussion. For example, as the moderator of the discussion, the chairman has an extra control that immediately turns off all delegate microphones.

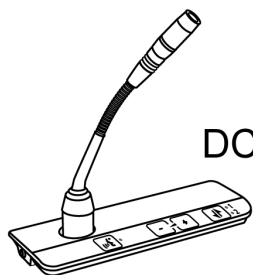

DC 5900 F

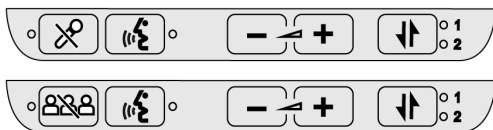

Delegate (Participant)

Chairman (Moderator)

Interpreter

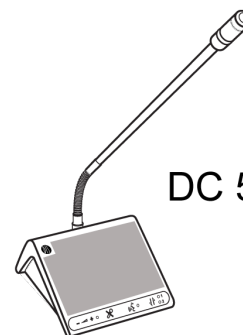



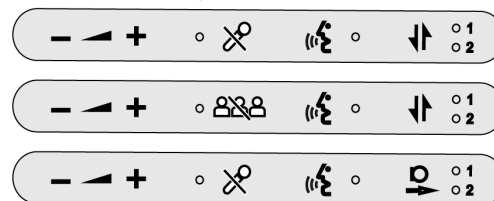

DC 5980 P



Using the Controls

Icon	Name	Description
	Speech	Press to turn on the microphone or add the user to the request list, depending on the system operation mode set in the CU.

Icon	Name	Description
	Mute	Press and hold to temporarily mute the audio from the microphone. During this time, the delegate will retain speaking privileges but the microphone will not pass audio to the floor sound. The microphone light ring is off during mute.
	Delegate Off	The chairman uses this button to immediately turn off all delegate microphones.
	Interpreter Output Channel	Selects the transmitting (outbound) channel of the interpreter station. Note: Only available for the DC 5980 P portable unit.
	Interpretation Monitoring	Scroll through the channels to select an audio source for monitoring on headphones. Channels 1 and 2 select a language interpretation source; floor sound is selected when the LEDs are off.
	Headphone Volume	Increase or decrease the volume of the headphone audio signal.

Overlay Variations

DC 5980 P Portable Unit

Delegates

Buttons	Image
<ul style="list-style-type: none"> • speech • mute • Interpretation monitoring • headphone volume 	

Buttons	Image
<ul style="list-style-type: none"> • speech • Interpretation monitoring • headphone volume 	

Chairman

Buttons	Image
<ul style="list-style-type: none"> • speech • delegate off • Interpretation monitoring • headphone volume 	

Interpreter



Buttons	Image
<ul style="list-style-type: none"> • speech • mute • interpreter channel send • headphone volume 	

DC 5900 F Flushmount Unit

The DC 5900 F flushmount unit has two options for the front plate:

FP 5981 F Front Plate (with interpretation monitoring)

Delegates



Buttons	Image
<ul style="list-style-type: none"> • speech • mute • interpretation monitoring • headphone volume 	
<ul style="list-style-type: none"> • speech • interpretation monitoring • headphone volume 	

Chairman

Buttons	Image
<ul style="list-style-type: none"> • speech • delegate off • interpretation monitoring • headphone volume 	

FP 5921 F Front Plate (without interpretation monitoring)

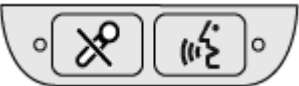
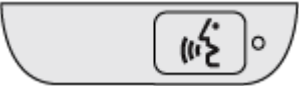
Delegates

Buttons	Image
<ul style="list-style-type: none"> • speech • mute 	
<ul style="list-style-type: none"> • speech 	
<ul style="list-style-type: none"> • No buttons 	

Chairman

Buttons	Image
<ul style="list-style-type: none">• speech• delegate off	 A rectangular control panel with rounded corners. It features two square buttons. The left button contains an icon of three people with a diagonal slash through them, representing a 'delegate off' function. The right button contains an icon of a microphone with sound waves, representing a 'speech' function. There are small circular indicators on the far left and far right of the panel.

Gooseneck Microphones

GM 592x Series

The DIS GM 592x microphone delivers excellent audio performance with a frequency response specifically tailored for speech. The gooseneck is on the base of the microphone, providing flexible positioning. A red LED ring at the top of the microphone clearly indicates when the microphone is active and the participant is speaking.

Two models are available:

- **GM 5923:** 40 cm (16 in.)
- **GM 5924:** 50 cm (20 in.)

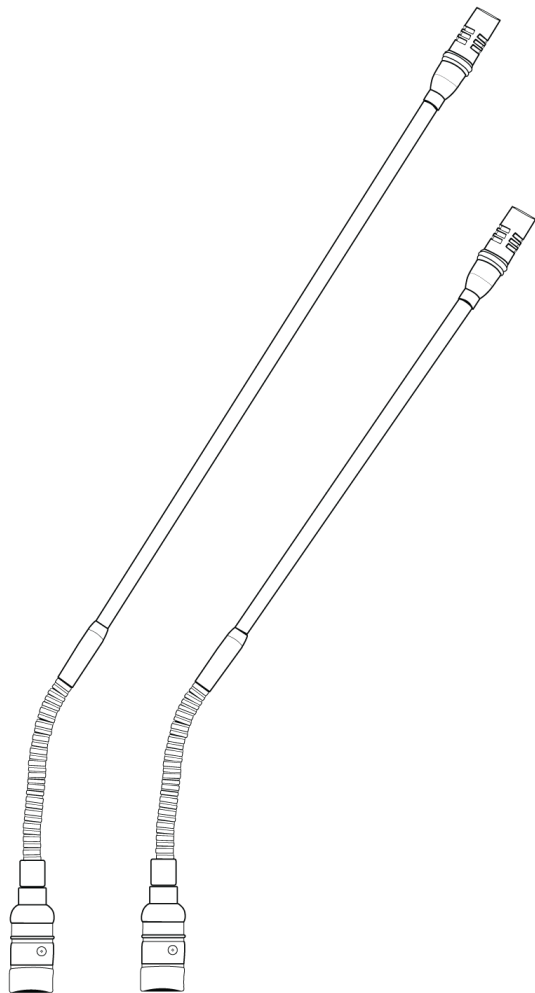

DIS GM 592x

MX 400 Gooseneck for Flushmount Units

The DC 5900 F Flushmount discussion unit functions with Shure MX 400 RLP series microphones. Featuring legendary Shure audio performance and build quality, CommShield® Technology eliminates noise caused by smart phones, tablets, WiFi and other RFI. A red LED ring at the top of the microphone clearly indicates when the microphone is active and the participant is speaking.

Simply screw the AC 5901 XLR adapter to the bottom of the microphone, and insert it into discussion unit.

- **MX 405 RLP:** 15 cm (6 in.)
- **MX 410 RLP:** 25 cm (10 in.)
- **MX 415 RLP:** 38 cm (15 in.)

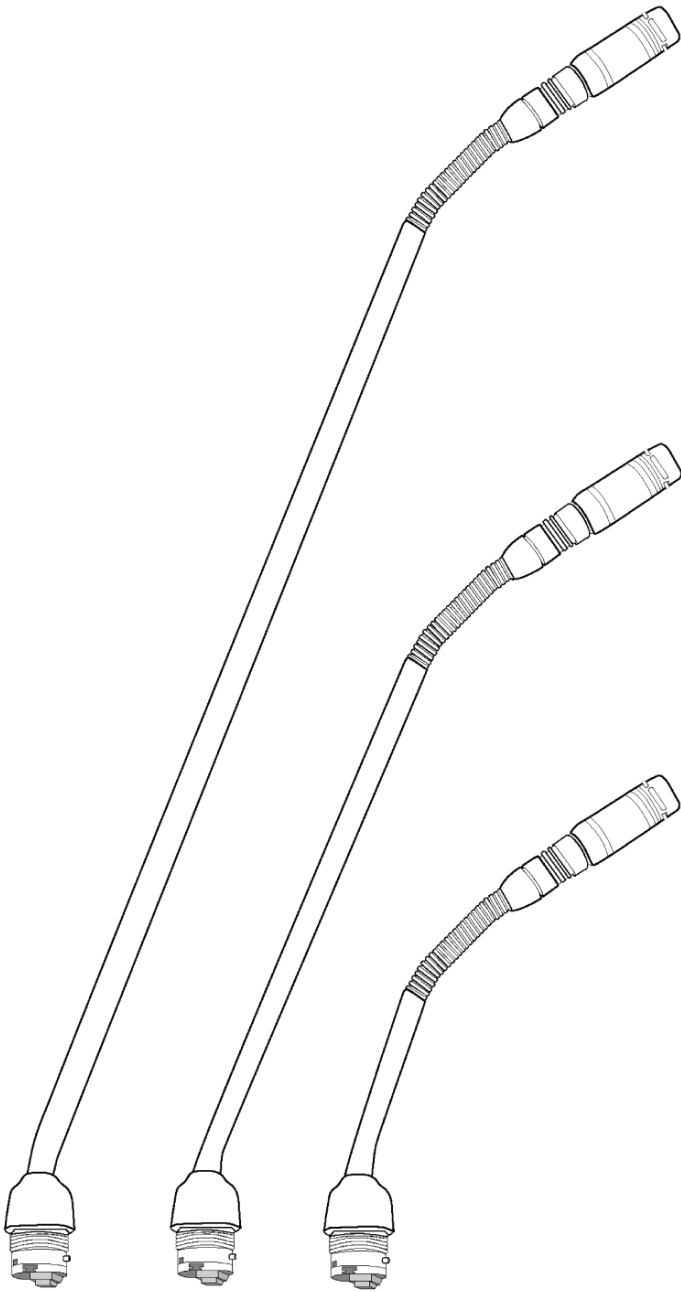

Shure MX 4xx RLP



AC 5901 XLR Adapter

Additional Compatible Equipment

The following units are available to use in the DDS 5900 system:

Additional Power and Advanced Setup	
EX 6010 Extension Unit	Extension unit provides four chain outputs, each with independent power supplies and data refreshing capabilities.
RP 6004 Repeater/Splitter	Refreshes data signal for long cable runs and provides four additional outputs for discussion unit chains.
PS-6000 Power Inserter	Provides power for up to 50 discussion units.
JB 6104 Junction Box	Provides four tap-out points for discussion units. Each tap-out supports a single discussion unit that can be connected or disconnected without damage to the unit.
RC 6000 Redundancy Controller	Enables the connection of a redundant PS-CCU power supply to protect the CCU operation against power failures.
SZ 6104 Switcher	Connects two CCUs for advanced system configurations and installations that share resources across multiple rooms.

Accessories	
Headphones	<ul style="list-style-type: none"> • DH 6021: Stereo on-ear headphones • DH 6223: Stereo stethoscope headphones • DH 6225: Mono ear-clip headphone

Hardware Installation

Microphone units operate by connecting in series from the central unit. Power, audio, and data are transported over a shielded Cat 5e cable from one unit to the next. This topology enables flexible and inexpensive installation for large groups of people.

Rackmounting the CCU

Install the central control unit in a standard 19" rack using the supplied 19" brackets. Remove the screws holding the top and bottom covers, then attach the brackets to the front of the unit using the same screws.

Important: Use the two 10 mm length self-threading screws closest to the front and the 8 mm length threaded screw furthest from the front.

The built-in fan draws air in on the left side and exhausts air on the right, and so does not require extra space above or below for cooling.

Connecting the DCS-LAN Equipment

Shure offers cables designed specifically for the DIS line of conferencing and discussion equipment. The Shure EC 6001 are high-quality Ethernet cables available various lengths from 0.5 m to 100 m. Each cable has been tested to ensure reliable system performance. See the accessories section for ordering information on the EC 6001-xx.

Important: Cables and connectors must be shielded for stable system performance. If an installation does not use Shure EC 6001 cables, they must follow the Cat5e cable requirements.

DDS 5900 Cable Requirements

Cat5e Cable Requirements

Type	Cat5e (or higher) twisted pair
Shielding	F/UTP or U/FTP
Connector	Shielded RJ45
Weight	AWG 24
Maximum Cable Length	<ul style="list-style-type: none"> • DIS-CCU only: 120 m • DIS-CCU with repeater units: 480 m

Important: Cables and connectors must be shielded for stable system performance. If an installation does not use Shure EC 6001 cables, they must follow the Cat5e cable requirements.

Using Patch Panels

When designing a system with a patch panel, crimp the cable to the female shielded connector on the panel. Then simply use short jumper cables to connect to the microphone units. Make sure the chain is always terminated by a microphone unit or a termination plug included in the SPS CU spare parts package.

Connecting Microphone Units and DCS-LAN Components

Microphone units and DCS-LAN components are connected in sequence (daisy-chain) using the two RJ45 ports on each unit. The connectors are interchangeable; simply connect the previous unit to one port, and the following unit to the other port. Always use shielded Cat5e (or higher) cabling for reliable system performance.

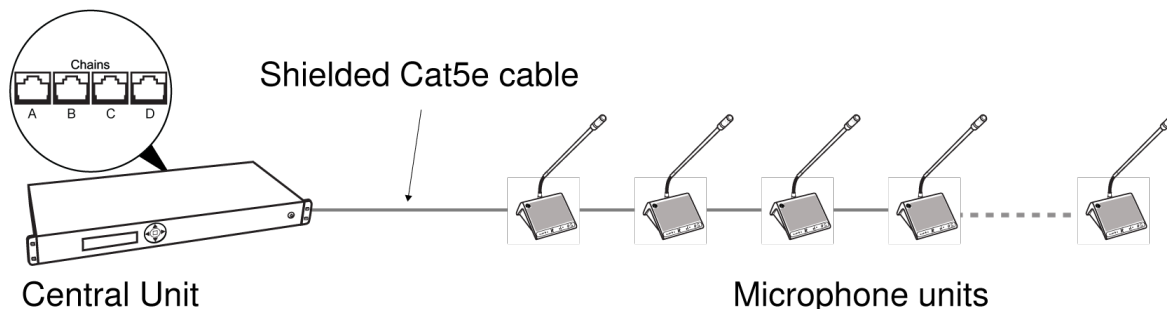

Power, control data, and audio are transported from one unit to the next over the same shielded Cat5e cable.

To protect the equipment, ensure that the central control unit (CCU) **is always off** when connecting or disconnecting the microphone units. Use any of the four chain outputs (A, B, C, and/or D) for connecting DCS-LAN components.

1. Power off the CCU to protect the equipment during set up.
2. Connect a chain output on the CCU to the first microphone unit with the shielded Cat5e cable.
3. Connect the rest of the microphone units in sequence, using the RJ45 jacks on the bottom of each unit.
4. Turn on the CCU by pressing the power button. The microphone units will power on. The unit is stable once the control button LEDs stop flashing.

Note: Do not turn off CCU power until the system has stabilized

Connection Diagrams

The following system diagrams illustrate typical hardware connections to the DIS-CCU central control unit. Actual installations may use different combinations of hardware, but follow the general concepts outlined below.

Note: Flushmount and portable discussion units are interchangeable in the following drawings, unless noted.

Basic Setup with Discussion Units

The system is operational without the use of a computer. Use the CCU navigation screen to set up the installation.

Note: This setup does not support the Manual microphone mode, since the browser interface is required for turning microphones on and off.

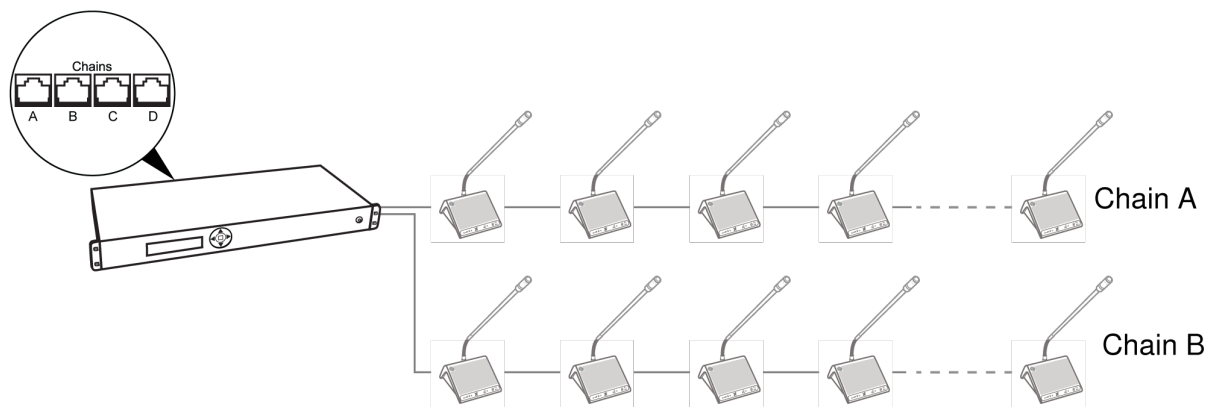

Basic System with Multiple Chains

Computer for Advanced Management

Connect a computer to the central control unit for comprehensive management of the system through a web browser. Connect an Ethernet cable from the dedicated TCP/IP port to a computer.

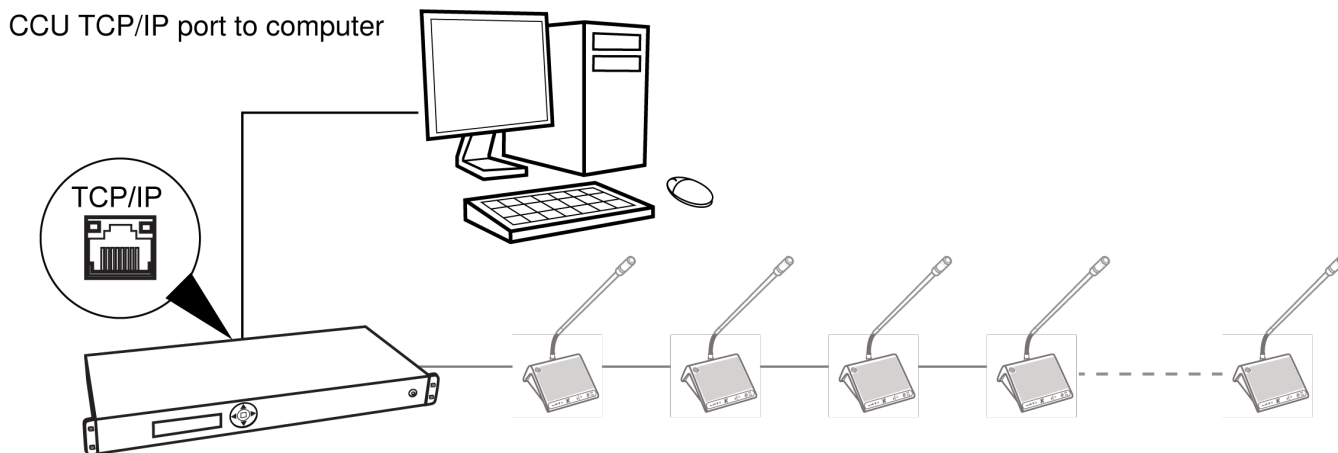

Computer Control

Tablet or Laptop for Wireless Control

Use a wireless router to access the web browser from a laptop or tablet. The web browser on a mobile device offers the same comprehensive system management.

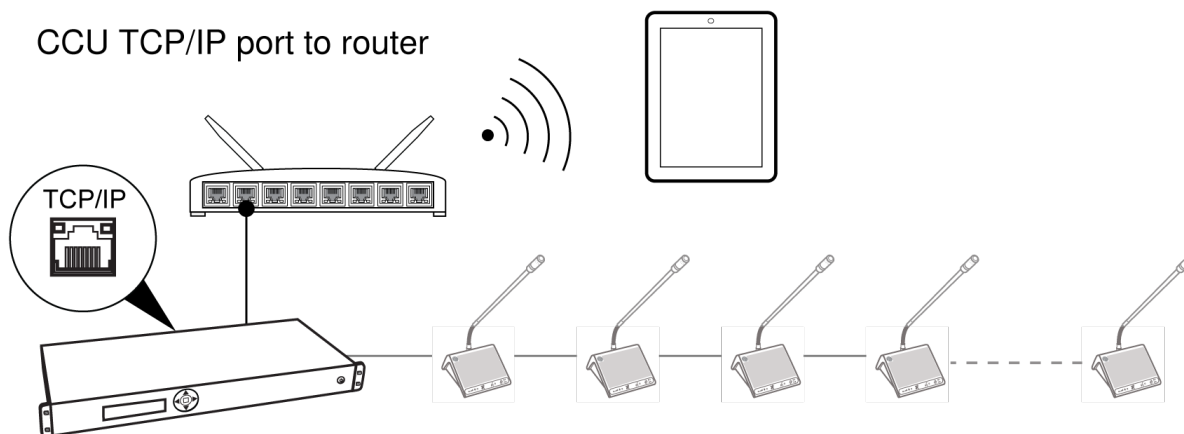

Wireless Control

Interpretation Units

The DDS 5900 Discussion System supports bilingual discussion, routing an interpretation channel to each discussion unit. Program the DC 5980 P portable discussion unit for use as an interpretation station. Other participants use the headphone jack on their unit to listen to the interpretation channel of their choice.

Typically, a separate room or booth is dedicated for interpreters for greater sound isolation. Units can connect in any order in the DCS-LAN chain, irrespective of operation mode of the adjacent unit.

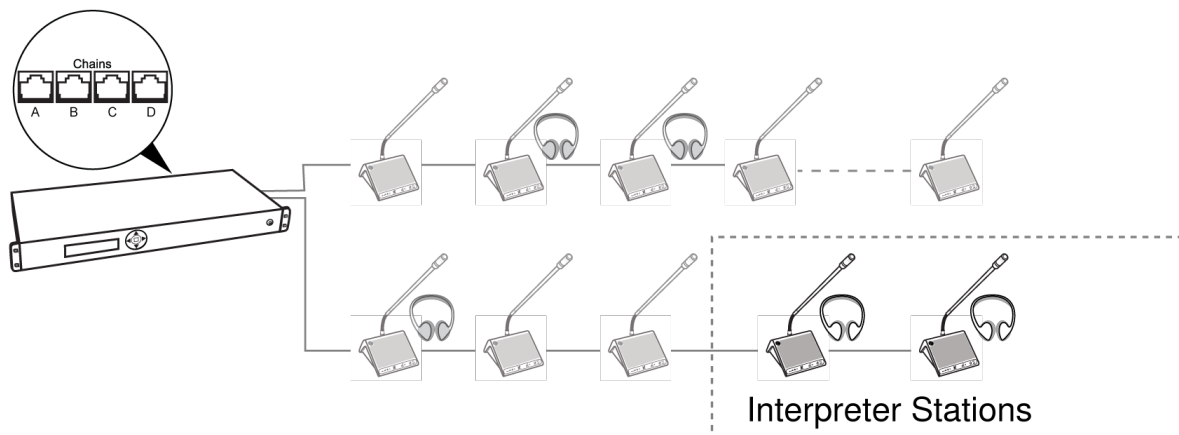

Interpretation Units

Audio Recorder

Connect an audio recorder to the analog outputs of the CCU to record floor audio, translations, or a specific set of microphones. Use the browser interface to buss units to groups and assign them to the specific output (A-H). Connect the XLR outputs of the CCU to the inputs of an audio recorder.

Analog outputs to recorder

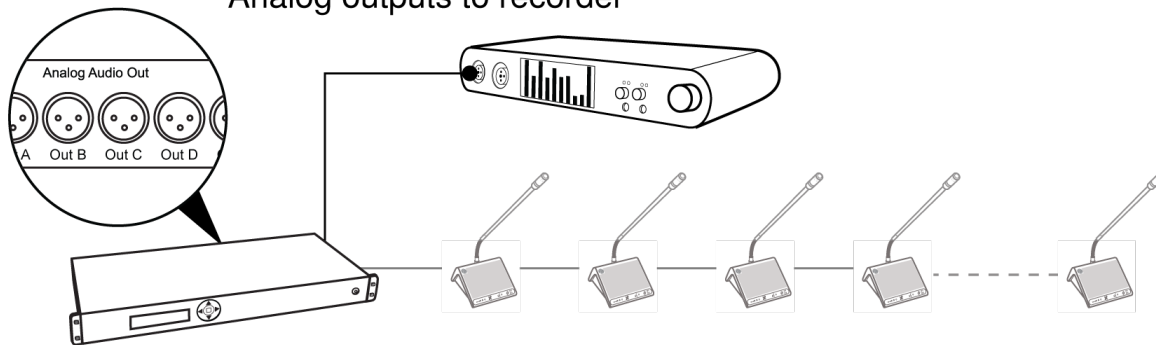

Recording Audio

Mixer or DSP

Connect a mixer to the CCU analog outputs to control individual microphone volume or equalization. Use the browser interface to buss units to groups and assign them to the specific output (A-H).

To return the audio to the DDS 5900 system:

1. Connect the output of the external device to Audio Input 1 on the CCU
2. Route the Input 1 audio by selecting the Loudspeaker and Ch. 0 and deselecting Out A (Group) Audio > Input Control > Audio In 1
3. To avoid a feedback loop, turn off the internal Floor routing by deselecting Loudspeaker and Ch. 0: Audio > Input Control > Floor

Analog outputs to DSP

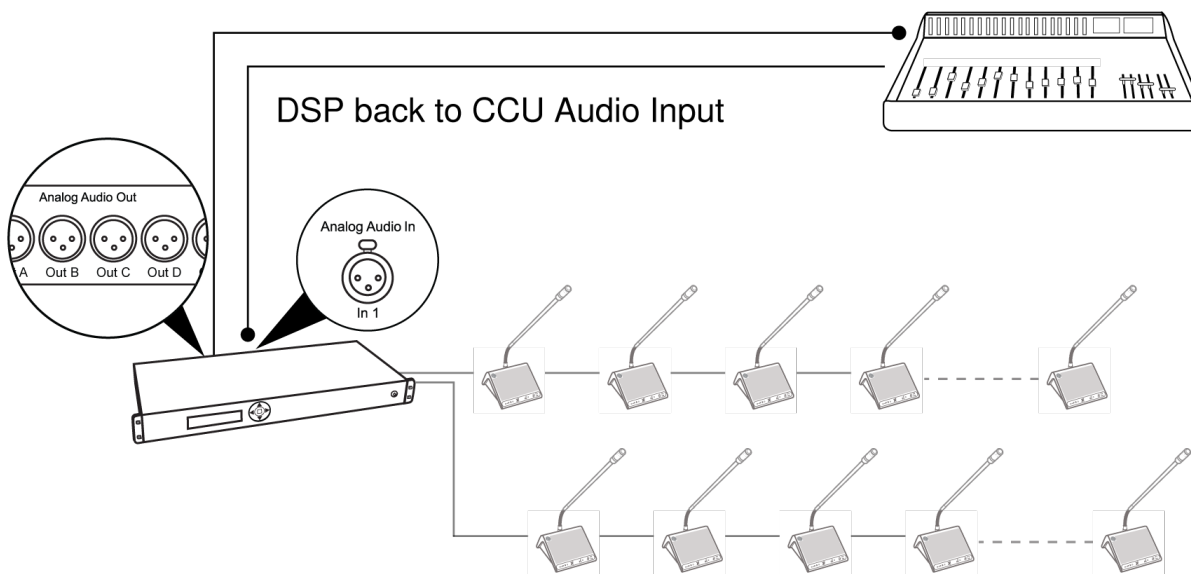

Inserting a Mixer or DSP

Wireless Language Distribution

For additional monitoring, connect a wireless language distribution system to one of the CCU audio outputs. Use the browser interface to select the desired microphones (seat) for that group output (A-H). The DCS 6000 Digital Infrared Language System transmits this audio signal to a number of listening stations.

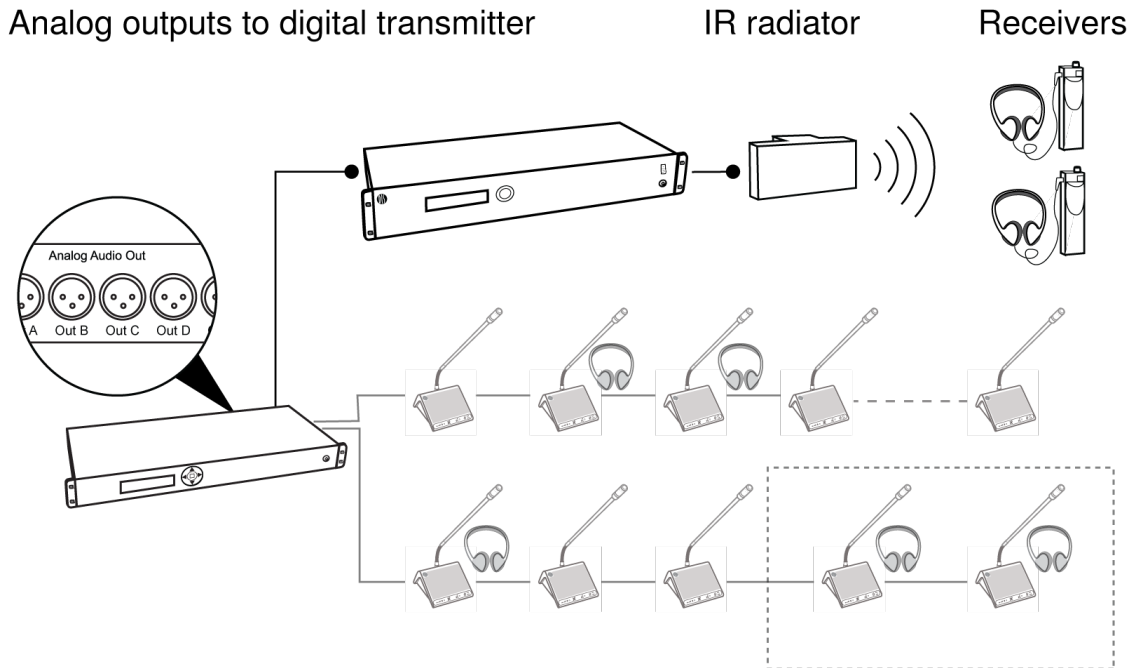

Wireless Language Distribution

Emergency Signal

Input 2 is designed to broadcast an Emergency Evacuation Message (EEM), overriding the discussion in the event of an emergency. A switch (normally-open) must be connected to the emergency switch connector. When the switch is closed an "Emergency Evacuation Message (EEM)" audio signal present on the 'In 2' input is distributed to all output channels, overriding all other audio inputs.

Power Requirements

For most installations, the DIS-CCU supplies sufficient power for the discussion units. Depending on the setup, the CCU powers up to 50 units at a time without additional equipment. The number of supported discussion units depends on the size and layout of the installation.

Note: maximum cable length in one chain is 120 m before a repeater unit.

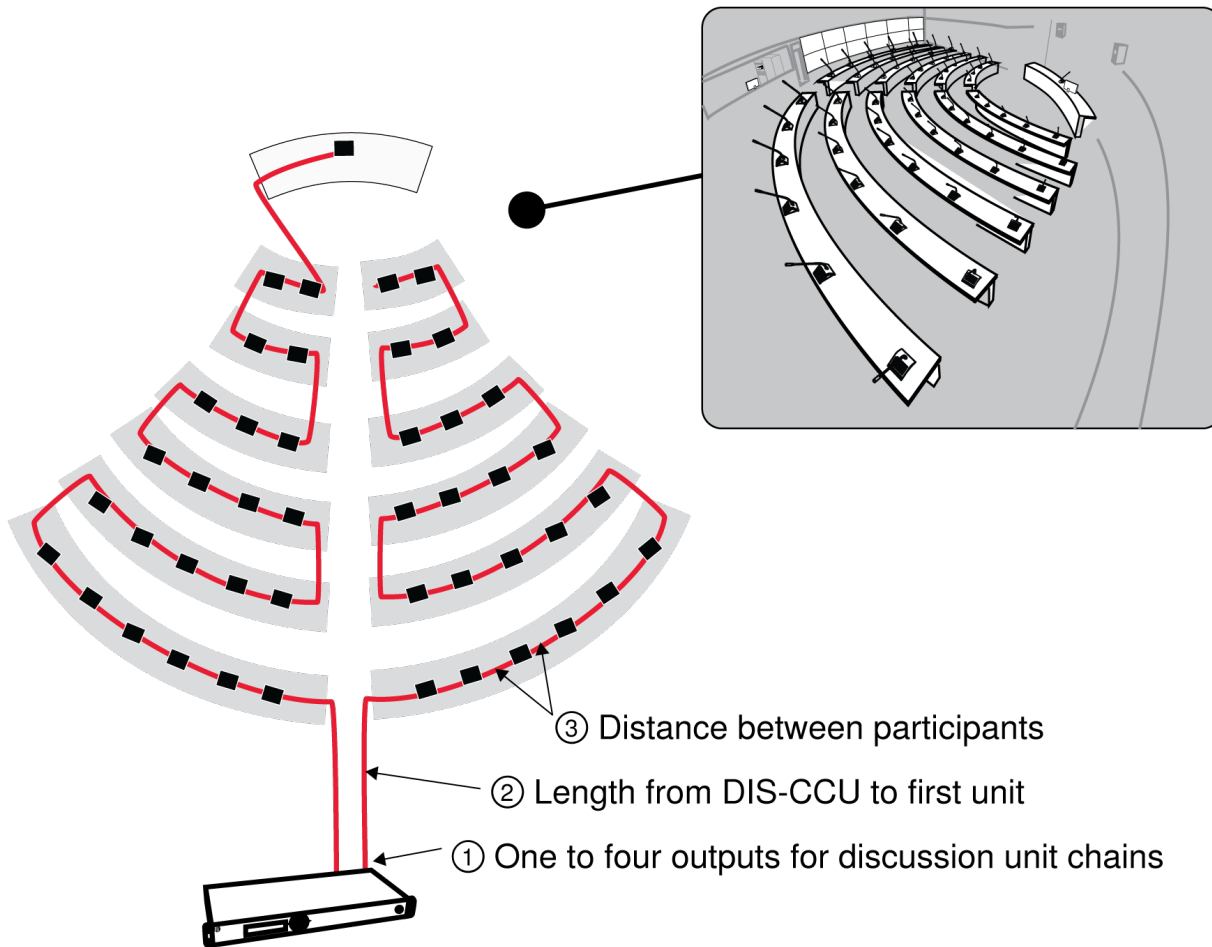

Power Depends on Installation Variables

To maximize the unit count without adding equipment:

1. Use multiple chain outputs from the CCU. Units must be divided evenly across each chain
2. Position the CCU so that the cable distance to the discussion unit chain is as short as possible
3. Keep the total cable length as short as possible by decreasing space between units

Discussion Units Powered by the DIS-CCU

The following tables show how to connect the most discussion units without adding additional equipment.

Note: When using multiple chains, distribute the number of units evenly across the chains to maximize unit count.

1 m Spacing Between Discussion Units

Cable length from CCU to the first unit	Estimated Number of Discussion Units Powered from CCU			
	One Chain	Two Chains	Three chains	Four chains
10 m	43	47	48	48

Cable length from CCU to the first unit	Estimated Number of Discussion Units Powered from CCU			
	One Chain	Two Chains	Three chains	Four chains
30 m	39	45	47	48
50 m	36	43	45	46
100 m	21	38	42	44

2 m Spacing Between Discussion Units

Cable length from CCU to the first unit	Estimated Number of Discussion Units Powered from CCU			
	One Chain	Two Chains	Three chains	Four chains
10 m	41	46	48	48
30 m	37	44	46	48
50 m	34	42	45	46
100 m	11	22	33	43

Note: Power requirements for the DC 5900 F discussion unit vary depending on the configuration of the unit. Additional discussion units are supported when the loudspeaker is removed and when GM gooseneck microphones are used instead of the MX4xx series microphones.

Using Junction Boxes

The JB 6104 junction box adds four additional outputs to a point on the DCS-LAN chain. These four outputs are available for short-run connections to DUs, protecting the DCS-LAN chain from technical failures or hot-plugging damage. A single DU can connect to each JB output, with a maximum cable length of 10 m.

1 Chain, 2 Units per JB 6104

Cable length from CCU to the first unit	Cable Length Between each JB 6104	Number of JB 6104	Maximum Number of DUs
10 m	3 m	19	37
30 m	3 m	17	34
50 m	3 m	15	30
100 m	3 m	7	14

2 Chains, 2 Units per JB 6104

Cable length from CCU to the first unit	Cable Length Between each JB 6104	Number of JB 6104	Maximum Number of DUs
10 m	3 m	22	42
30 m	3 m	20	40
50 m	3 m	20	38
100 m	3 m	14	28

2 Chains, 4 Units per JB 6104

Cable length from CCU to the first unit	Cable Length Between each JB 6104	Number of JB 6104	Maximum Number of DUs
10 m	5 m	13	50
30 m	5 m	12	48
50 m	5 m	12	46
100 m	5 m	10	40

Installing Large Systems

Power Supplies for Additional Components

To add additional components to the system, add an inline or rackmount power supply to the discussion unit chain.

Inline Power Supply

Use the PI-6000 power inserter to add an inline power supply for approximately 50 more discussion units. The unit may be connected at any point in the chain to power the additional components. Multiple PI-6000 units can be used to reach the maximum 250 supported discussion units.

Note: The PI-6000 does not refresh the data signal, so total cable length cannot exceed 120 m.

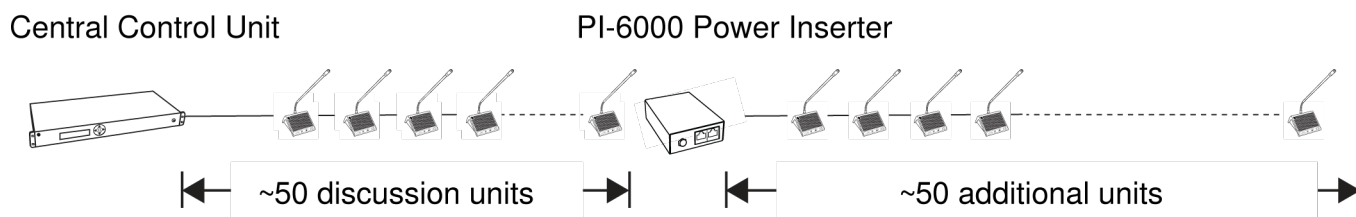

Inline Power Supply (1x)

Rackmount Power Supply for 4 Additional Chains

Use the EX 6010 rackmount extension unit to add additional components and configuration options. The unit expands the discussion unit chain into 4 separate outputs, each with a power supply equivalent of a CCU (approximately 50 units).

Note: The EX 6010 also refreshes the data signal, enabling an additional 120 m of cable from each port.

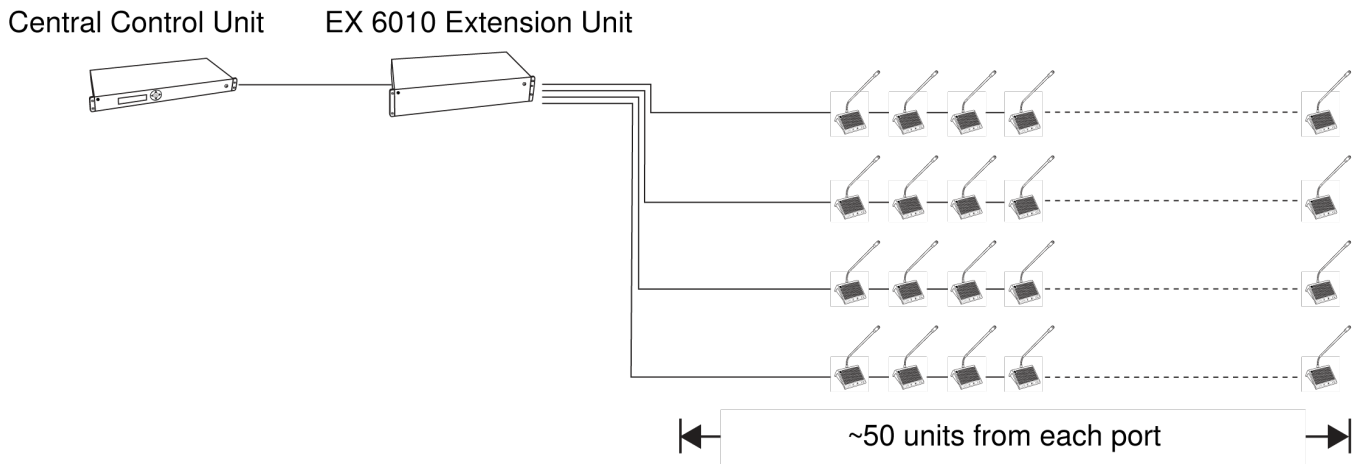

Rackmount Power Supply (x4)

Extending Total Cable Length

The CCU operates a system with up to 120 m of shielded Cat5e cable. To add more cable for large or more complex installations, add an RP 6004 Repeater before 120 m limit has been reached.

The RP 6004 connects anywhere in the DCS-LAN chain, refreshing audio and control data for the units that follow it. It provides four additional chain outputs that each operate for an additional 120 m.

The signal can be refreshed up to three times for a maximum cable length of 480 m.

Note: This unit does not add any power for components in the chain.

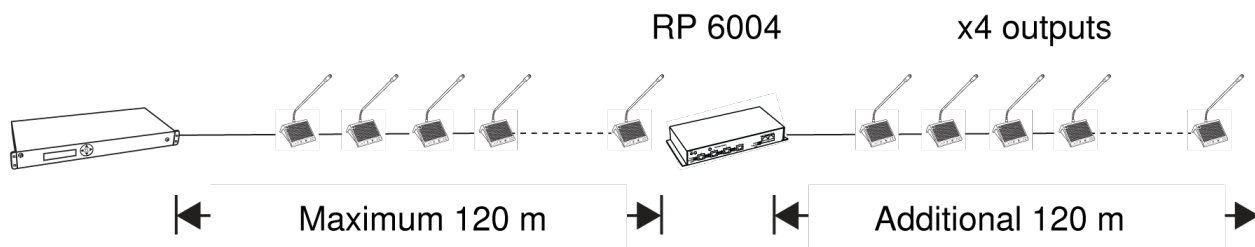

Inline Signal Repeater

Installing the DC 5900 F

Installing the Base

The DC 5900 base installs directly onto a table or podium.

1. Determine the location of the microphone and cut a hole with a diameter of 53 mm.
2. Use the base to mark the location for the screw and drill the holes.
3. Secure the base to the table with the screws.

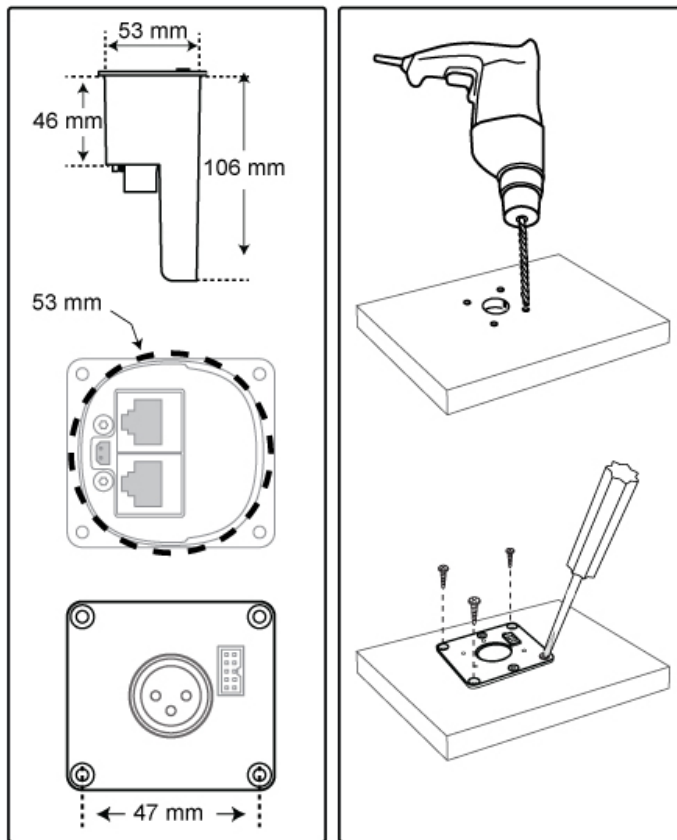

Installing the Loudspeaker

1. Determine the location of the speaker (<1m from the base to accommodate the cable) and cut a hole with a 53 mm diameter.
2. Insert the loudspeaker into the hole and connect the loudspeaker cable to the base unit. Make sure the cable is not pinched.
3. Align the loudspeaker with the base unit. Mark the location for the screws, spaced exactly 78 mm apart.
4. Drill the holes and secure the speaker to the table with the screws.
5. Snap the grill onto the loudspeaker cabinet.
6. Connect the cable from the loudspeaker to the DC 5900 F base

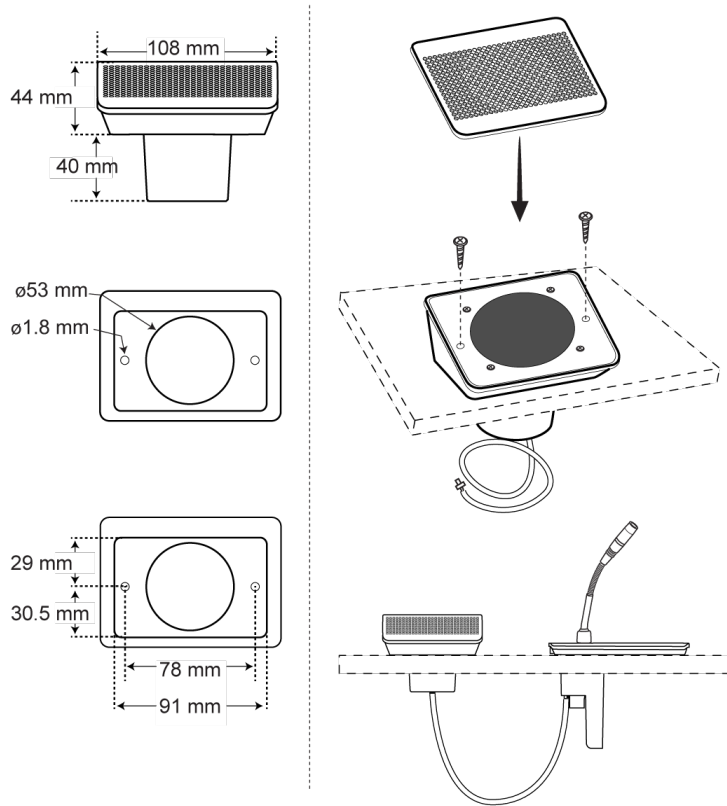

Bottom of LS 5900 F

Attaching the Front Plate

1. Align the front plate and place it onto the base.
2. Secure the plate to the base using the screws.
3. Snap the cover onto the front plate.

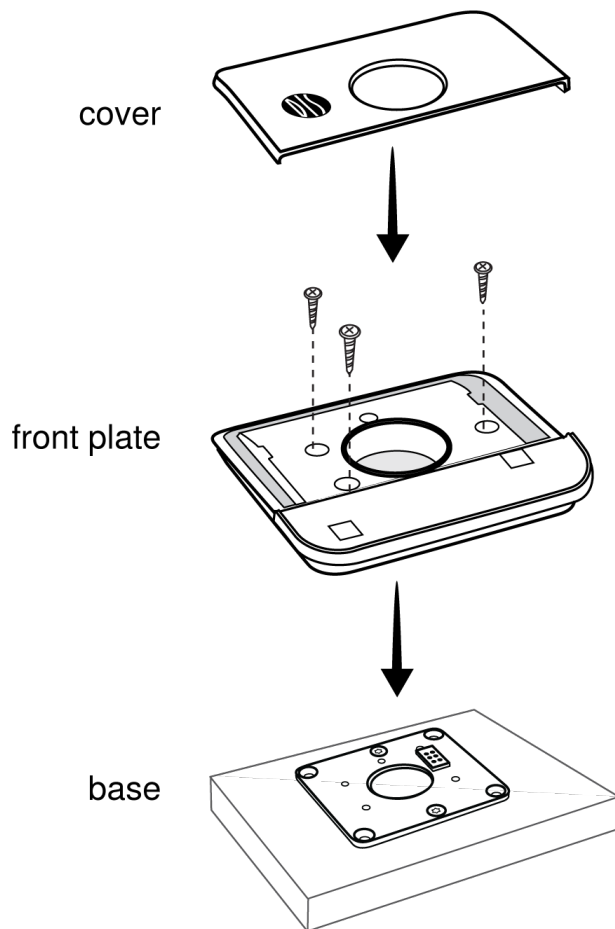

Attaching the Front Plate

Removal

To remove the front plate:

1. Locate the two holes on each side of the front plate.
2. Insert a paper clip in each hole to release the cover.
3. Pull up on the cover to separate the pieces.
4. Unscrew the front plate from base unit.

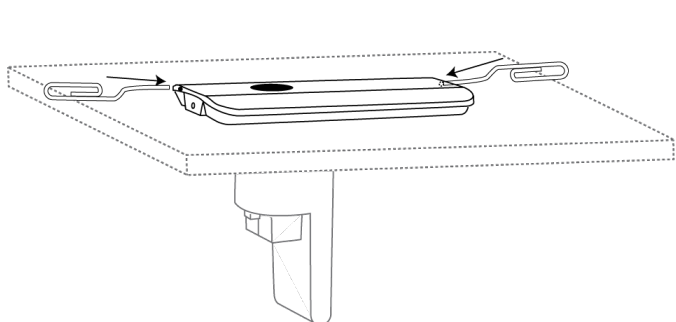

Use Paper Clips for Removal

Installation Best Practices

Follow these guidelines for the most reliable installation.

Continuity of Shielding

Shielding must be consistent through the DCS-LAN chain. Any cable or patch panel used for DIS components requires shielded RJ45 connectors. All DIS components feature shielded RJ45 female connectors.

Avoiding Accidental Grounding (Galvanic Isolation)

Avoid accidentally grounding the DCS-LAN signal with the chassis ground of a patch panel. The DCS-LAN uses the shield as a signal ground reference and cannot contact another ground anywhere in the connection.

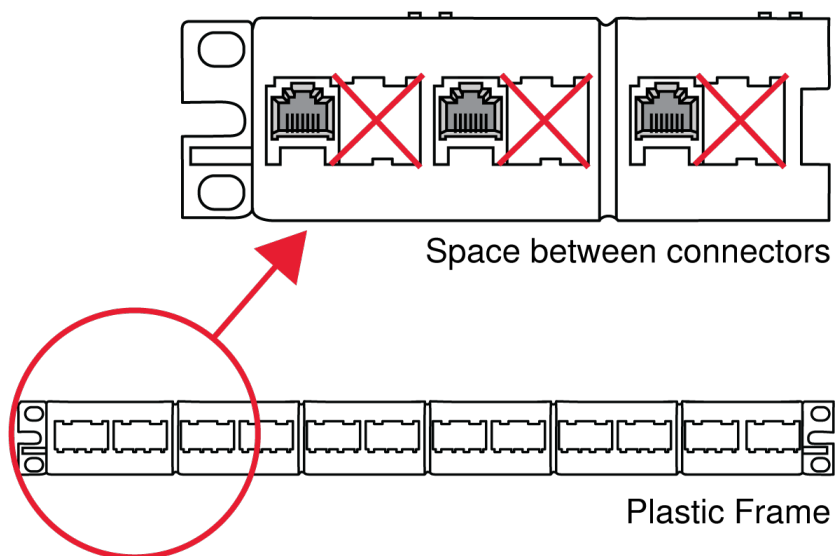

Avoid Grounding in a Patch Panel

To avoid ground issues:

- **Plastic frames in patch panel:** this ensures that the female RJ45 connectors do not ground to the chassis of the patch panel.
- **Blank space between connectors:** leave a space between each female RJ45 connector in a patch panel.
- **Shielding continuity:** each component in the chain must be shielded properly.

Note: The female connectors in all DIS components units feature an air gap that isolates the chassis of the connector and the chassis of the unit preventing any galvanic (physical and thus electrical) connection.

Properly Securing Cables

As with any cable carrying a signal, use care when installing the equipment.

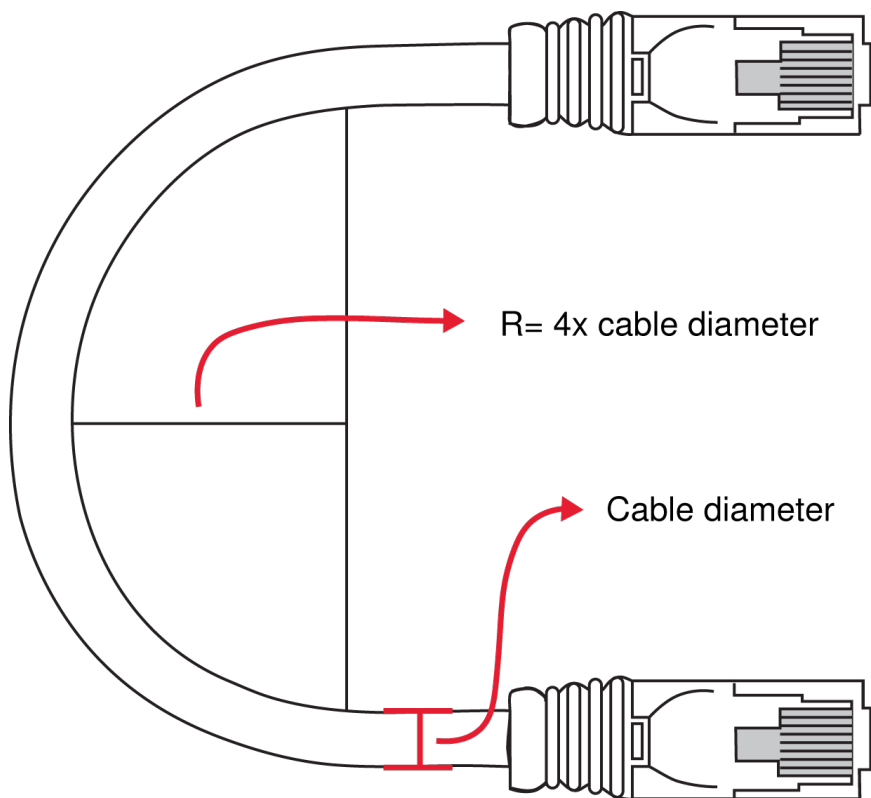

Bending Rule

Do not sharply bend the cable. Ethernet cables cannot bend more than four-times the diameter of the cable.

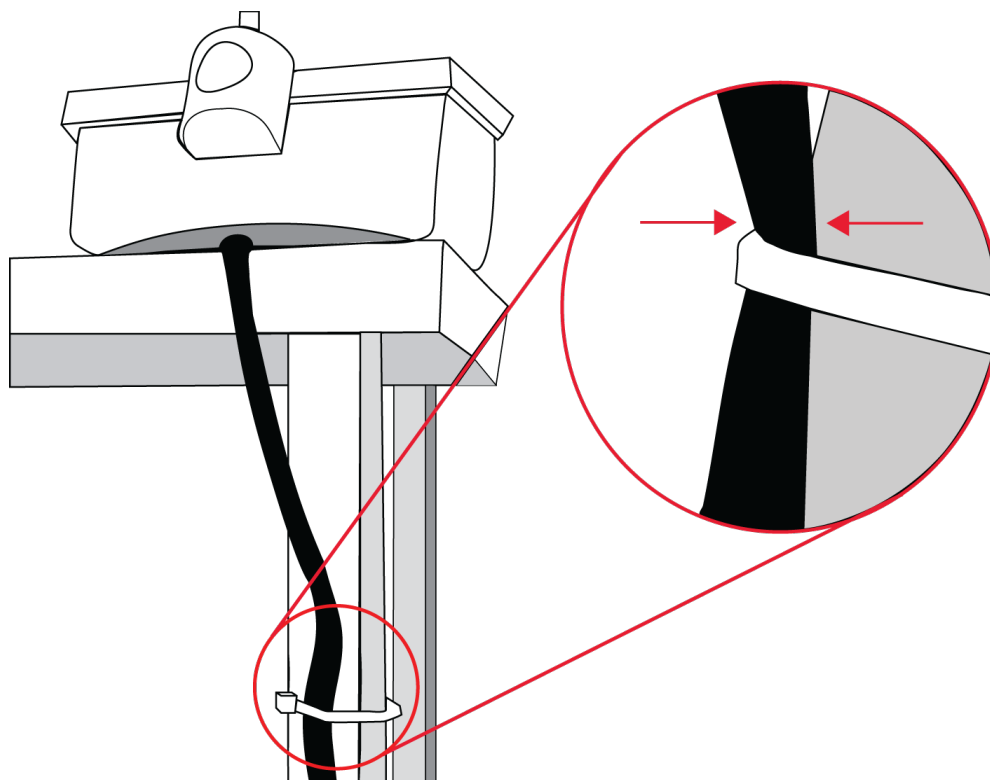

Pinching

Do not over-fasten the cable. A pinched cable may not operate correctly.

Using the Discussion Units

Attach the Touch-Button Overlay

Attach the touch-button overlay to each unit for basic microphone control. The discussion units use soft buttons that change functionality when programmed to different unit types. Button overlays are supplied with the discussion unit or with the central unit.

Warning: Overlays are not reusable. If a unit needs to be reconfigured, carefully remove the overlay and apply another one.

1. Choose an overlay for the unit.
2. Remove the protective paper from the back.
3. Place the overlay in the recess on the front of the unit.

Securing the Microphone

To lock the microphone into place, use the supplied hex key and turn counterclockwise.

DIS GM: Simply insert the microphone into the XLR socket. Adjust the gooseneck for proper position.

Shure MX4xxRLP: Attach the AC 5901 XLR/Microflex adapter to the microphone. Insert the adapter into the XLR socket of the flushmount unit.

Program the User Type

DDS 5900 discussion units are programmable, changing the function of the control buttons to support different user types. The three types are chairman, delegate, or interpreter, each requiring unique control functionality. The setting is stored in the unit, and persists after a power cycle.

Note: Flushmount units are not programmable as interpreter stations. Use the portable DC 5980 P unit for simultaneous interpretation.

Flushmount Units

To program the flushmount DC 5900 F discussion unit as a chairman or delegate, simply attach the button overlay. The overlay automatically programs the unit with the correct button functionality.

Reboot the system once all the overlays are attached to establish the configurations with the CU.

Portable Unit

Program the portable units by pressing the volume buttons and scrolling to the desired mode.

1. Power on the unit by properly connecting it to the DCS-LAN chain.
2. Press and hold the '-' and '+' volume buttons. The Speak light flashes to indicate the unit is ready for programming.
3. While continuing to press the volume buttons, press the channel scroll to the unit type. The type is indicated by the combination of channel LEDs; see the table below.

Changing Unit Type

Unit Type	Ch. 1	Ch. 2
Delegate with mute	Off	Off
Delegate without mute	On	Off
Chairman	Off	On
Interpreter	On	On

System Set Up

Web Interface

For comprehensive management and remote control of the system, open the web interface on a computer or tablet. The central control unit (DIS-CCU) provides a web server for system control from a web browser on a networked computer. The web app offers advanced parameters for setting up the system, and enables the chairman or moderator to manage microphones using participant names and seat numbers.

Note: The computer network is separate from the component network (DCS-LAN).

DIS-CCU 5900 System Setup

Microphone Control
Operation
Audio
Configuration
System
System Status
License
LAN Setup
Security
Language
Factory Defaults
Diagnostics

Unit Count

Chain	Found	Lost
A	2	0
B	4	0
C	0	0
D	0	0

System Status

Serial Number: 004.169.139

Serial Number	Chain	Type	State
004.169.139	A	DC59xx DM	Active
004.170.017	A	DC59xx DM	Active
001.127.085	B	6000 Unit	Locked-Incomp unit
000.010.107	B	6000 Unit	Locked-Incomp unit
001.163.044	B	6000 Unit	Locked-Incomp unit
001.097.246	B	6000 Unit	Locked-Incomp unit

Remove Unregistered Units

SHURE Copyright © 2015 - www.shure.com shure-ccu-jmi.local

System and Discussion Setup

DDS 5900 Web Interface

System Requirements

For best performance, always update the browser to the latest released version. The following browsers function properly with the system interface:

- Internet Explorer (IE) 8+
- Firefox 10+
- Safari
- Chrome
- Opera

Open the DIS-CCU System Interface

Follow these instructions to open the browser interface on a computer.

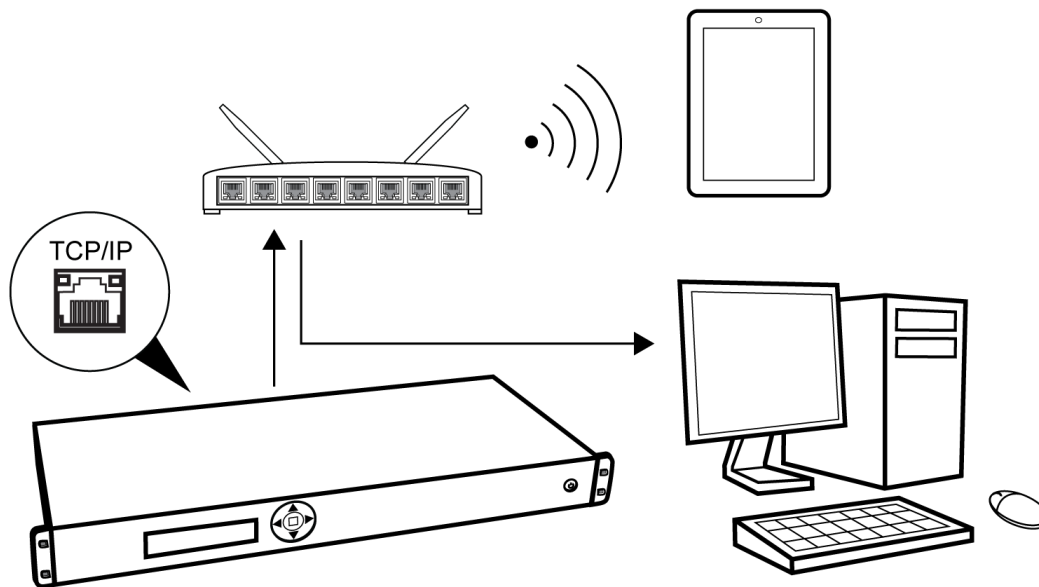

Connect to the CCU

1. Connect the computer to the TCP/IP port on the CCU.
2. Power on the equipment.
3. Assign the computer to automatically obtain an IP address. This enables the computer to automatically connect to the CCU.
4. Acquire an IP address by selecting Dynamic from the LAN Setup > Acquire IP addr. window.
5. View the IP address: LAN Setup > IP address setup .
6. Open the internet browser in the computer.
7. Type 'http://IP-address', where 'IP address' is the address noted from the CCU.
8. The browser interface opens.

Assigning the Network Address

Access to the system interface is available from two network addresses: IP address and hostname. Typing either address into a browser will access the interface of the connected CU.

Manage the network address from the browser: System > LAN Setup

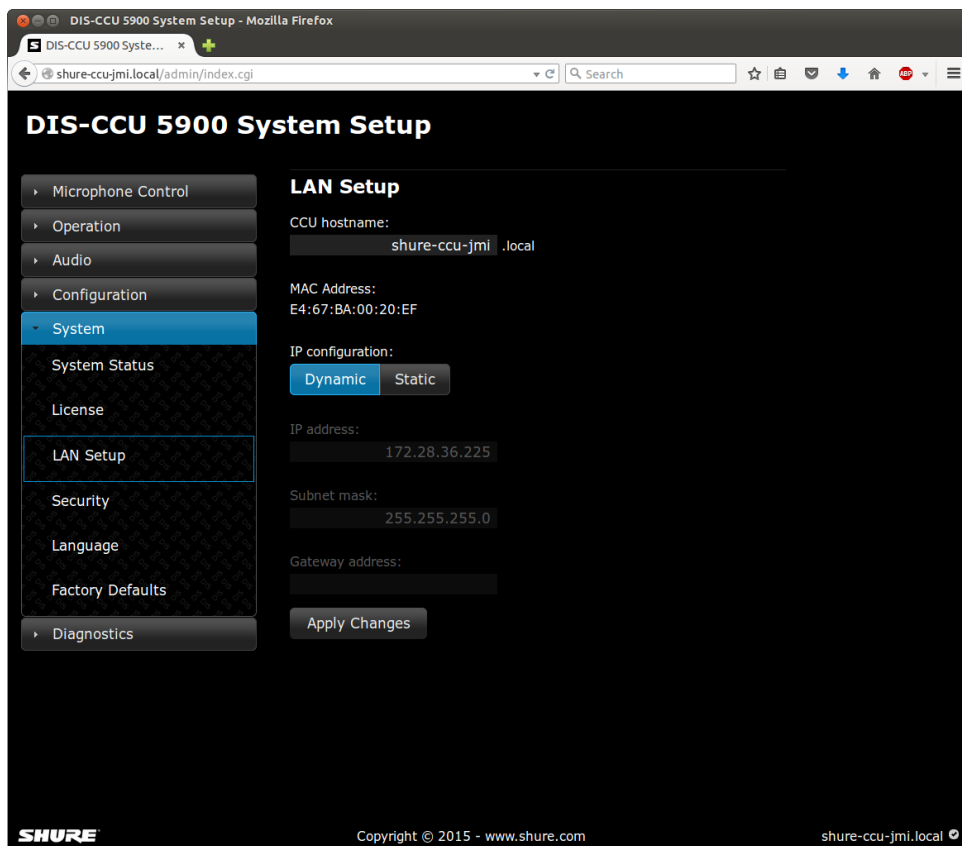

IP Address

Select 'Dynamic' if the CCU is connected to a network with a DHCP server. Otherwise select 'Static' and assign a fixed IP address to the CU. Default IP configuration is "Dynamic".

Select 'Apply Changes' to save the changes made.

View the IP address from the CCU front panel:

LAN setup > IP address setup > IP address > Actual IP address .

Hostname

The hostname is a user-defined name that can be assigned to the device to access the browser instead of using the IP address. The hostname is titled in a logical manner to easily identify the component on the network. More importantly, the hostname will not change on its own (unlike the IP setting), making it ideal for bookmarking.

For example, if the system is set up in the primary meeting room, the hostname could be called, "MainRoom" resulting in the address: <http://mainroom.local>.

1. Go to the LAN Setup page.
2. Under CCU hostname, select the default name and delete it.
3. Enter the new hostname.
4. Select the Apply Changes button to save the name.
5. Check the address by typing into the browser: <http://hostname.local>

6. If desired, bookmark the page.

Language Setting

The browser interface is supported in a variety of languages. Go to [System > Language](#) to select the desired language.

Albanian	Shqip
Arabic	اللغة العربية
Bosnian	Bosanski
Bulgarian	български
Chinese (Simplified)	中文 (简体)
Chinese (Traditional)	中文 (繁體)
Croatian	Hrvatski
Danish	Dansk
English	English
French	Francais
German	Deutsch
Greek	Ελληνική
Icelandic	Íslenska
Italian	Italiano
Japanese	日本語
Korean	한국인
Macedonian	македонски
Montenegrin Cyrillic	Црногорски
Montenegrin Latin	Crnogorski
Norwegian	Norsk
Persian	فارسی

Polish	Polski
Portuguese	Português
Russian	русский
Serbian Cyrillic	Српски
Serbian Latin	Srpski
Slovenian	Slovenski
Spanish	Español
Swedish	Svenska
Thai	ภาษาไทย
Vietnamese	Tiếng Việt

Additional Interface Pages for Meeting Participants

In addition to the administrator access to the web interface, there are two separate addresses useful to the participants during the meeting:

- Microphone control for speaker management
- Display-only page for meeting participants to view the speaker lists

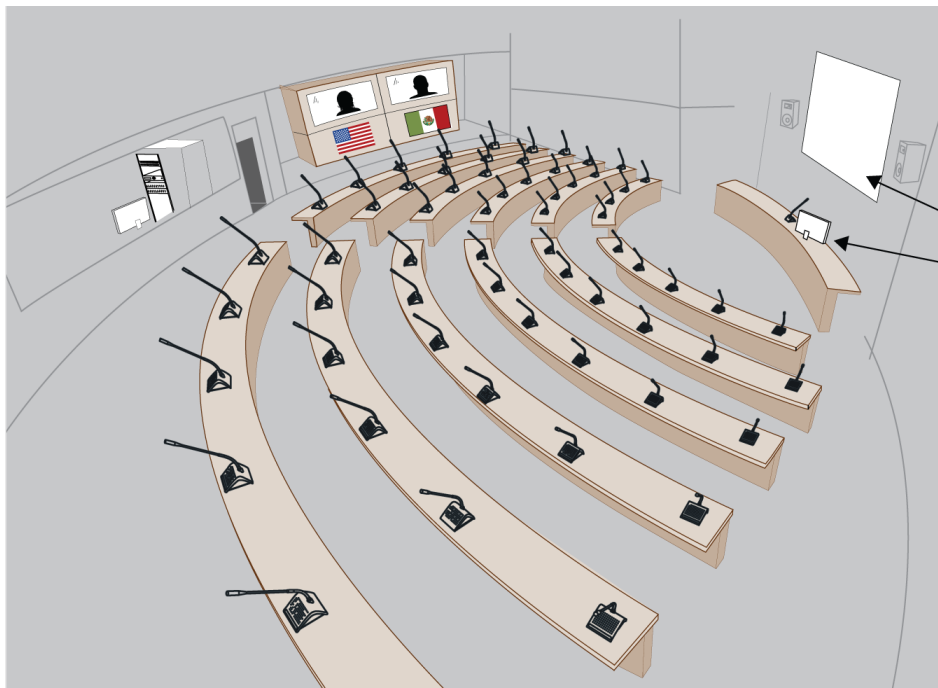

Display for participants

Microphone control for the chairman

By default, anyone can access these views from a computer or mobile device connected to the network. To protect these pages, the administrator can assign a password to each from the Security page.

Microphone Control Page

This page is dedicated for microphone control during the meeting. Use this view as a chairperson or meeting operator to manage speakers, speak requests, and replies.

For access, enter the IP address of the CCU, followed by /chairman (example: <http://172.17.11.137/chairman>).

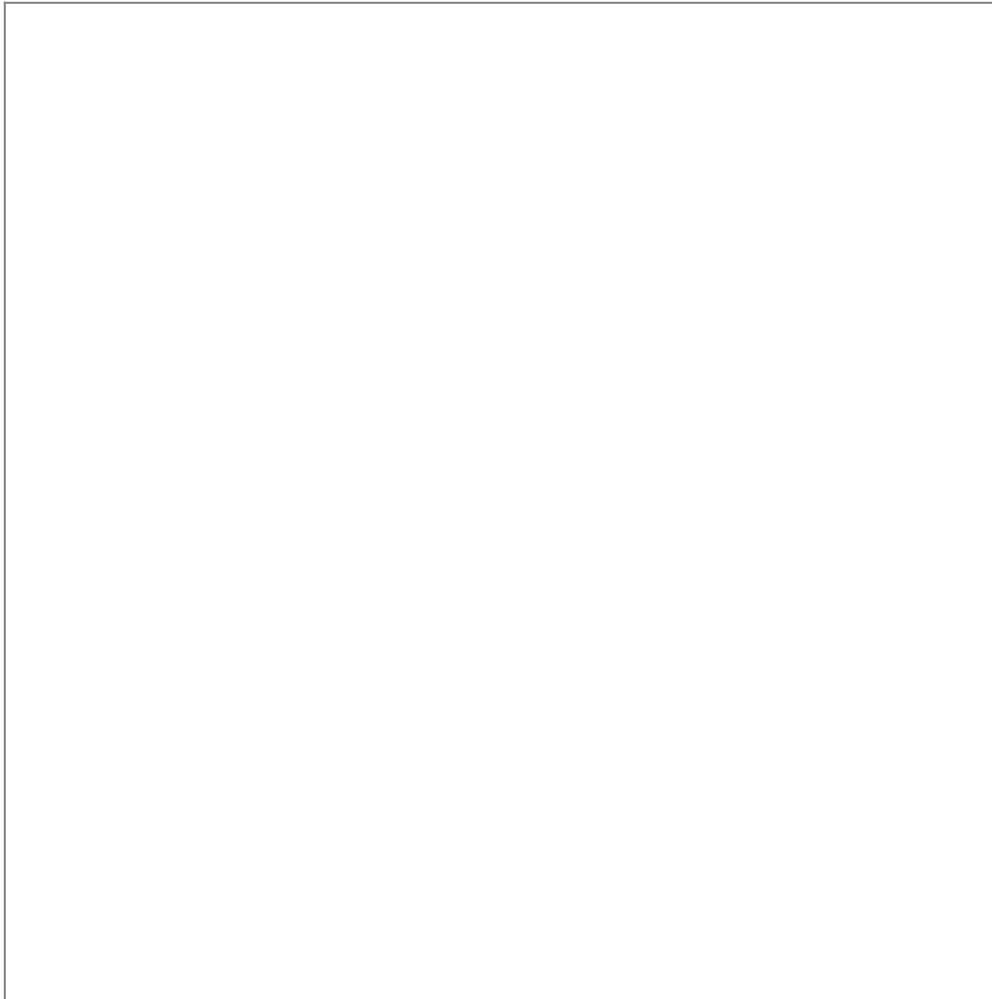

Display Page

The display page is used to provide the meeting participants with a view of the speaker, speak request, and reply lists.

For access, enter the IP address of the CCU, followed by /display (example: <http://172.17.11.137/display>).

Tip: Put the page in full-screen mode during the meeting:

- PC: F11
- Mac: ctrl + cmd + f

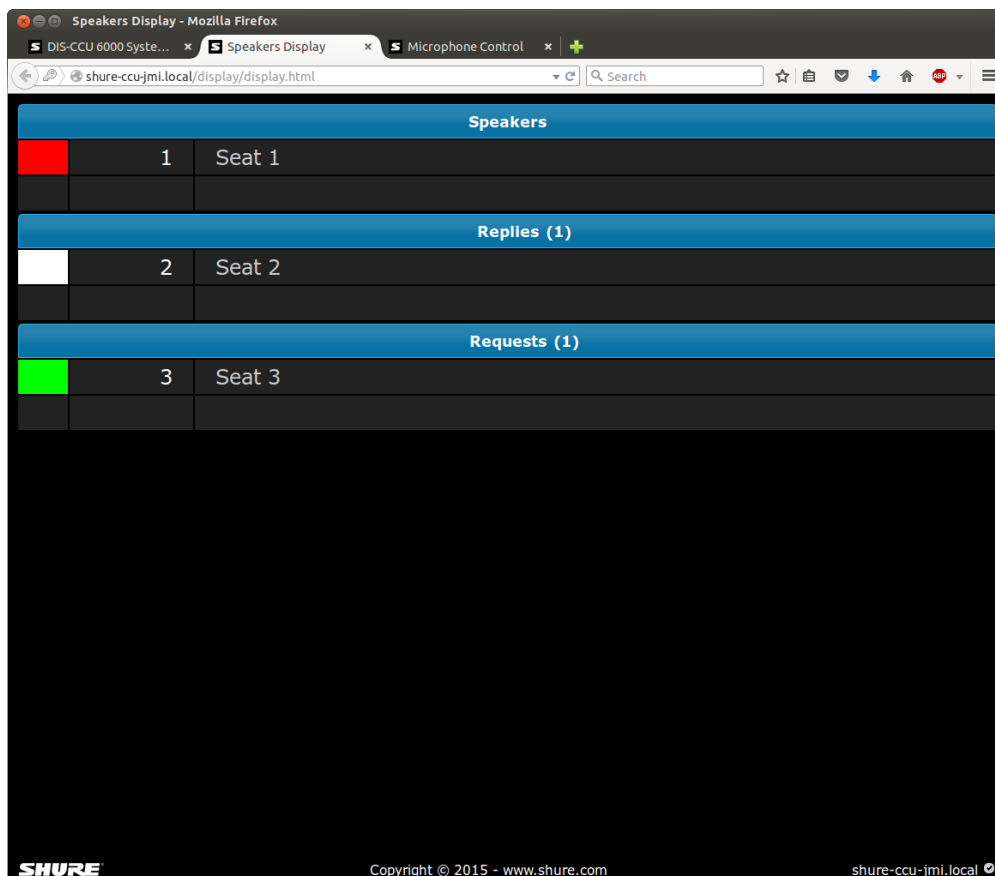

Security

DIS components use a proprietary codec algorithm to prevent unauthorized devices from listening to the audio signal. To further protect the discussion, assign a password to the browser interface and enable security features on wireless routers.

Password Protect the Browser Interface

You can assign a password to restrict access to the browser interface. An independent password is assignable to each of the three interface addresses: administrator, chairman, and display.

1. Sign into the browser interface as an administrator.
2. Go to the Security page (System > Security)
3. Enter a valid user name and password.
4. Select Change Password to save the login information.

Note: passwords are cleared when the unit is reset to factory default settings.

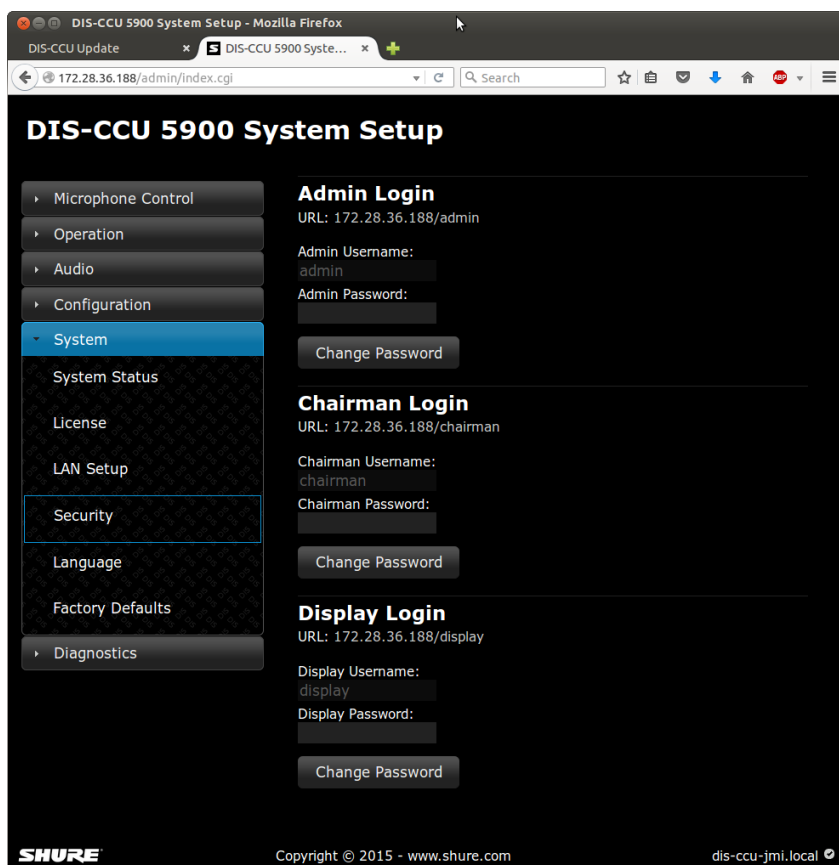

Removing the Password

To clear the password access to the CCU, restore factory default settings.

Note: Resetting to factory defaults will erase all delegate, system, and IP settings.

<p>From the Hardware</p>	<ol style="list-style-type: none"> 1. Go to the front panel of the CCU. 2. Scroll the main menu to Restore Factory Defaults 3. Press the center button to enter menu 4. Press the center button again to confirm the reset. 5. Wait for the system to reboot. The computer will lose connection to the browser interface during this time.
<p>From the Browser Interface</p>	<ol style="list-style-type: none"> 1. Open the CCU browser interface 2. Go to Configuration > Factory Defaults 3. Select the Reset button to reset the system. 4. Wait for the system to reboot. During the reboot process, the computer cannot access the browser interface.

Isolating the Network

For maximum security, isolate the control network with a dedicated computer or a protected router.

- Dedicate one computer as the control station. Connect it directly to the CCU TCP/IP port. This ensures that wireless devices cannot access the IP address of the control software.
- If multiple computers or tablets are required, assign a password encryption for the router. The most effective standard is the Wireless Protected Access II (WPA2), which uses Advanced Encryption Standard (AES) for encryption. Reference the router user guide to set it up.

Assigning Names and Seat Numbers

When the discussion begins, the chairman or discussion moderator will need to refer to the participants by either name, seat number, or both. The proper assignment of names and seat numbers is critical to ensure the continuity of the discussion.

When logging in with the browser interface to an installation for the first time, each microphone unit appears with its default name. Units are automatically assigned a seat number. Chairman units also appear in the participant setup page. Use the participant setup page to match the units to the anticipated seating chart.

1. Make sure all units are connected and functioning.
 - Go to the System Status page for details [System > System Status](#)
 - All properly connected microphone units are listed with a default serial and seat number automatically assigned by the software.
 - Disconnected units will display as Lost and can be removed from the list by selecting [Remove - Unregistered Units](#)
2. Reassign seat numbers to match the actual seat numbers in the room or on your seating chart.
 1. Go to the Unit to Seat Relation page [Configuration > Unit to Seat Relation](#) .
 2. Match the entries in the seat table to the corresponding units in the room by placing the cursor over the seat number field. The light ring on the microphone flashes red.
 3. Change the seat number by clicking in the field.
3. Draw a seating chart, or diagram, that represents the room. Number each seat that requires a discussion unit. Add participant names to the seating chart.
4. Go back to the Participant Setup page [Configuration > Participant Setup](#) and change the descriptions next to the assigned seat numbers to the appropriate participant names.

DIS-CCU 5900 System Setup

- Microphone Control
- Operation
- Audio
- Configuration**
- Participant Setup
- Unit Setup**
- Unit Type Change
- System
- Diagnostics

Unit Setup

Seat Number: 1

Serial Number	Seat Number
004.169.139	1
004.170.017	2

SHURE Copyright © 2015 - www.shure.com shure-ccu-jmi.local

Reassign Seat Numbers

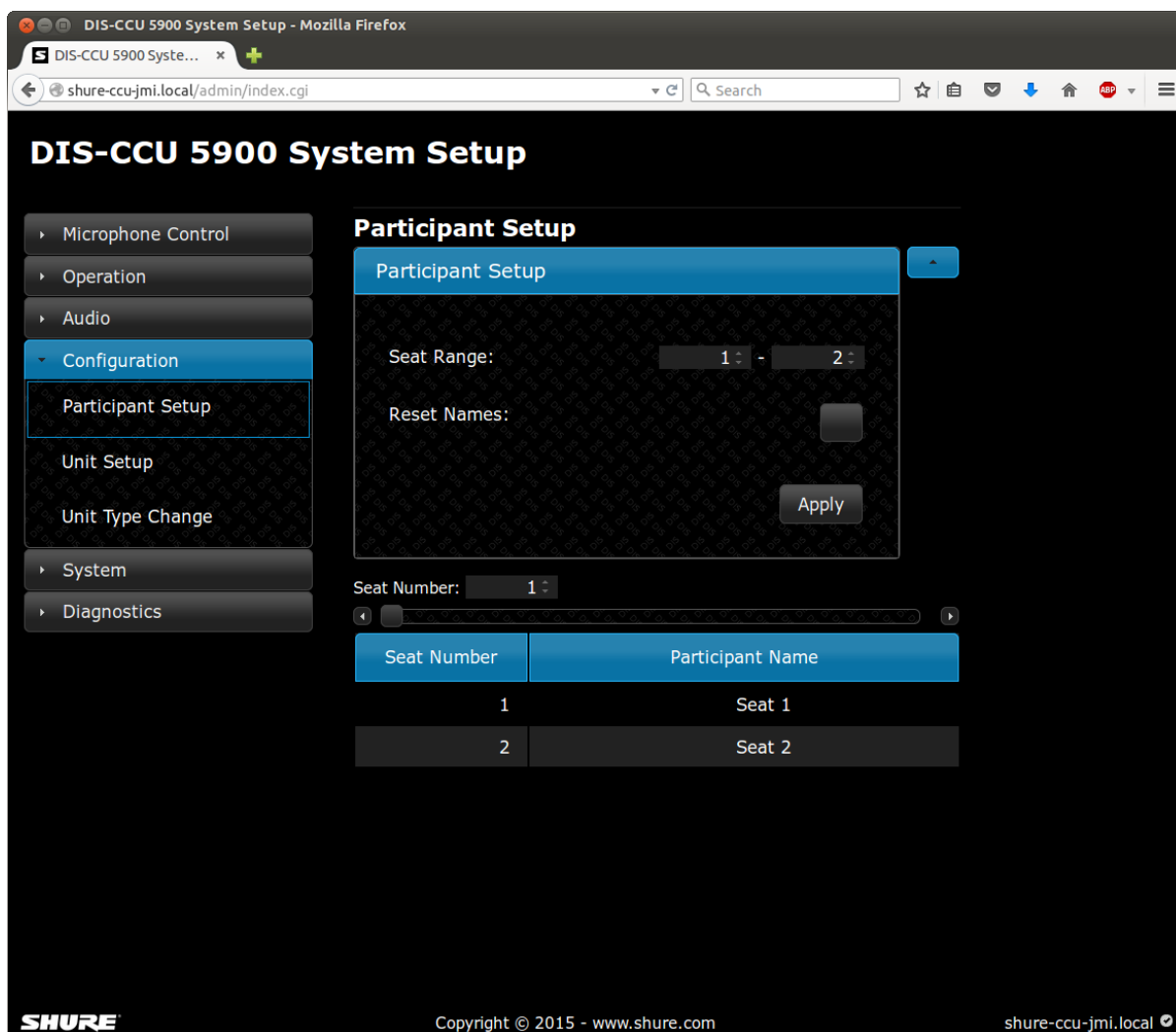

Add Participant names

Audio Settings

The Floor Mix

When a microphone is turned on, the audio is routed to the main mix (Group A) by default. This mix is often referred to as the floor mix because it transmits the audio from anyone participating in the meeting. Interpreters also listen to the floor to provide language interpretation for multilingual discussions.

By default, the floor mix is routed to the loudspeaker and headphone output (Channel 0) of each connected microphone unit.

Route Microphones to Groups

Go to the Group Setup page [Audio > Group Setup](#) to view or modify the microphone routing.

For each microphone, select one of the following options:

- Group A only (default)
- Group A + another group
- Group B, C, D, E, F, G, or H
- None

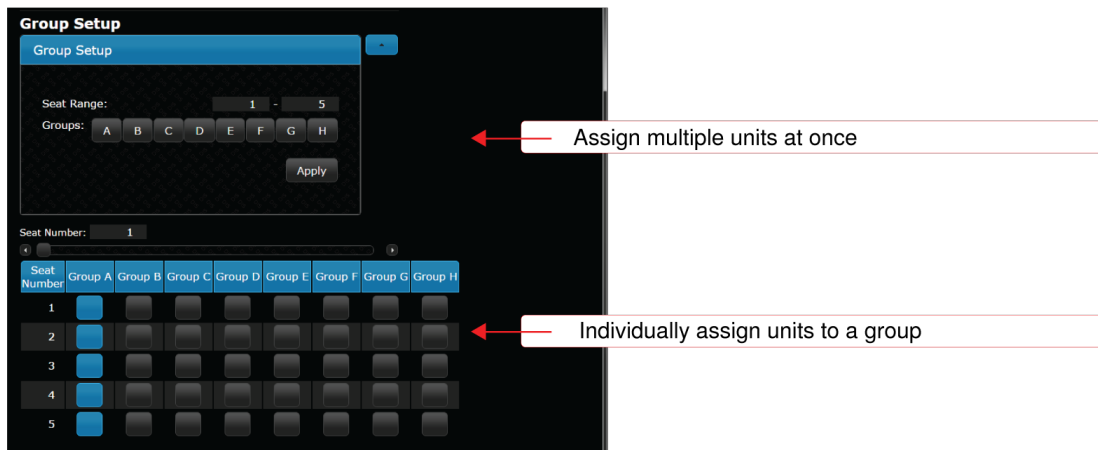

Floor Mix on the Loudspeakers

Loudspeakers are included in most microphone units for localized sound-reinforcement of the discussion. When a participant uses their microphone, their speech is heard at other unit loudspeakers. This improves speech clarity in large rooms and reduces typical problems associated with sound reinforcement systems.

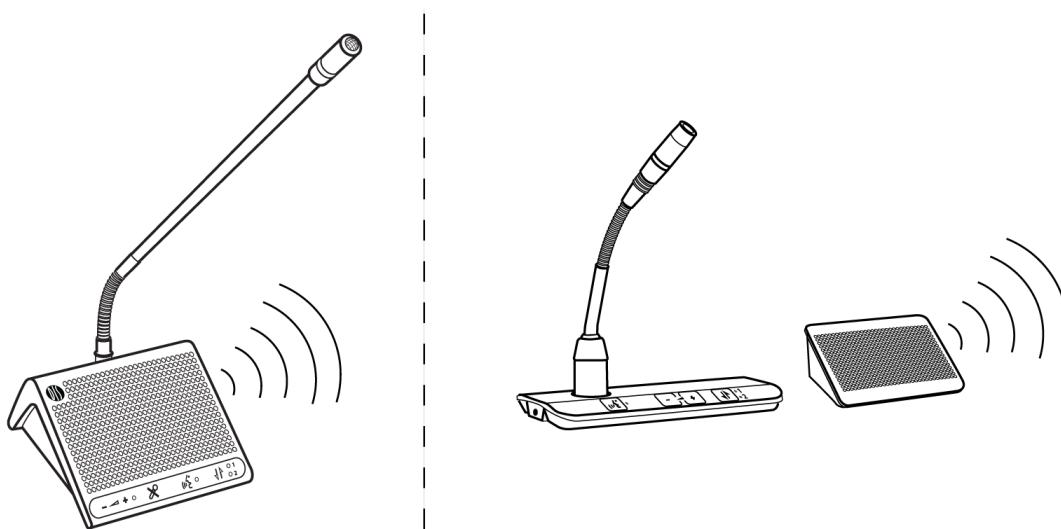

A Loudspeaker for Each Participant

Each participant can listen to the discussion on a personal loudspeaker attached to the microphone unit.

- **Flushmounted DC 5900 F:** The flushmount unit requires the attachment of the LS 5900 F loudspeaker.
- **Portable DC 5980 P:** Each portable discussion unit includes an integrated loudspeaker.

Note: To avoid feedback, the loudspeaker is turned off when that microphone is active.

Loudspeaker Adjustment

Loudspeaker volume is a system setting that applies to all connected units. Volume is adjustable from -0 dB (no attenuation) to -40 dB, including off (mute). To adjust the volume:

From the Browser Interface	Go to the Loudspeaker Control page (Audio > Loudspeaker Control)
From the CU	Scroll to the Loudspeaker Menu (loudspk. control > loudspk. volume > db)

Headphone Channels

Most microphone units include a headphone output for listening to interpreter channels or other participants on the floor channel. Each participant chooses their channel from the microphone unit channel selectors.

Channels 1 and 2 are dedicated for language interpretation. Participants select one of the channels to listen to their language during a bilingual event. The audio source comes from interpreter stations transmitting onto their selected channel.

Channel 0 (the floor channel) is used by interpreters to provide simultaneous interpretation of the discussion. This channel is also selectable by other participants to listen to the floor channel on headphones (channel 0 = LEDs off).

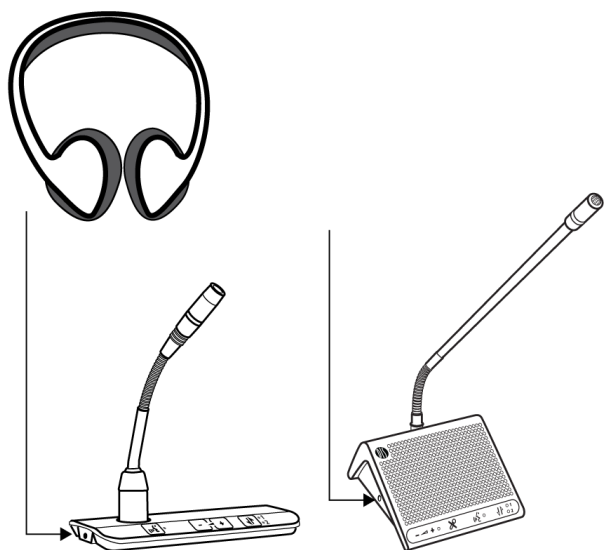

Use Headphones for Language Interpretation

1. Connect headphones to the headphone jack on the side of the discussion unit.
2. Select a channel by pressing the selector buttons on the front of the unit.
 - Channel 0 - Floor Mix (LEDs off)
 - Channel 1

- Channel 2
3. Adjust the volume of the headphones using the + or - buttons on the unit.

Audio Source for the Loudspeaker and Headphones

By default all microphones are routed to loudspeaker and headphone mixes.

To change the audio source:

1. Route microphones to Group A to add them to the floor mix (all selected by default) Audio > Group Setup

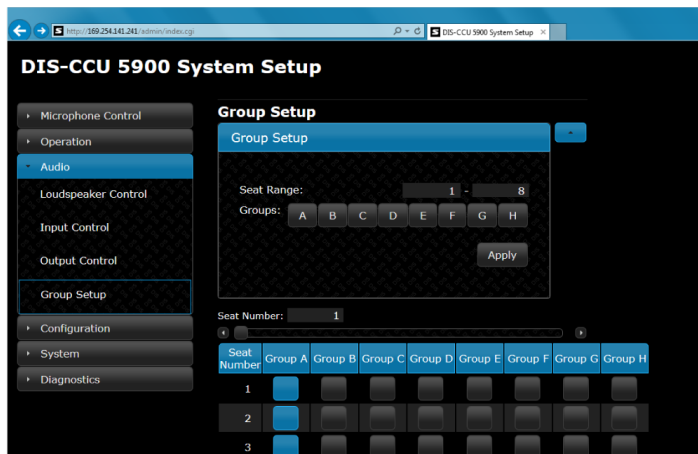

↑
Group A = Floor

2. Select the audio sources for the loudspeaker and Channel 0 (headphone) Audio > Input Control :
 - Floor (default)
 - Audio In 1
 - Audio In 2

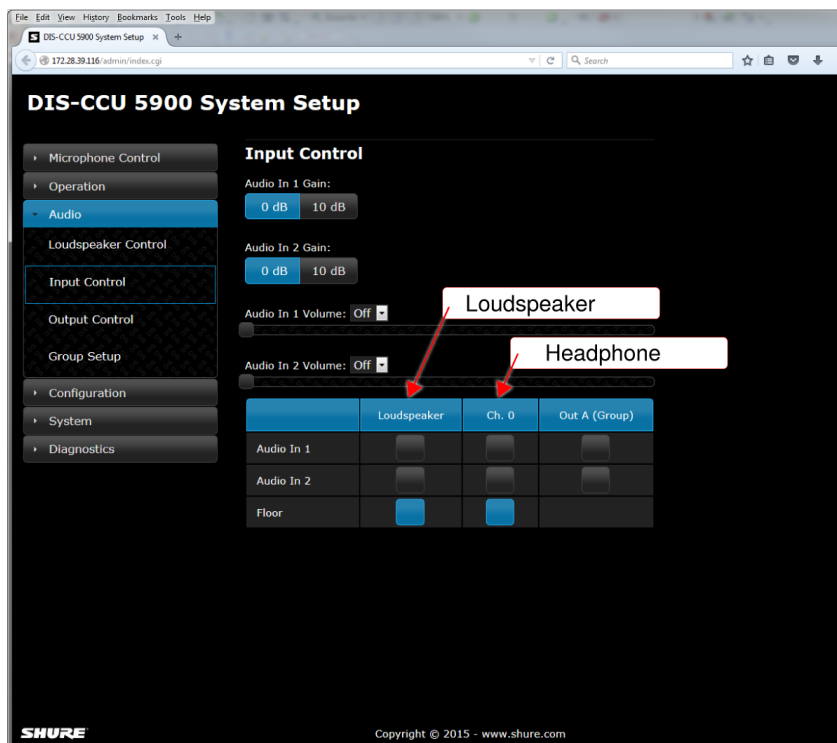

Analog Audio Outputs

Eight analog outputs are available for recording, language distribution system, teleconferencing unit, or an external PA system.

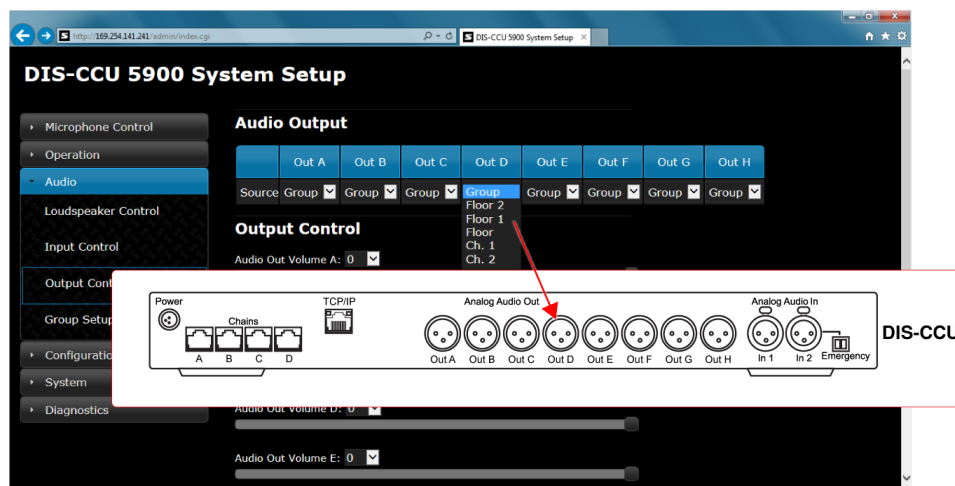

Eight Analog Outputs

Go to **Audio > Output Control** and choose from the following options:

- **Group:** Eight separate groups for isolating specific microphones. This selection corresponds to the groups configured from the **Group Setup** page.

Note: If the group buss is not used for the corresponding XLR output, it is unavailable in the routing matrix.

- **Ch. 1 & 2:** Interpretation channels
- **Floor:** The audio from all open microphones that are routed to Group A (floor mix). There are three variations on this mix to chose from:
 - Ch. 0: Headphone mix with AGC, useful for sending to an IR language distribution system.
 - Floor 1: Loudspeaker mix, useful for sending to a PA or broadcast equipment.
 - Floor 2: Loudspeaker mix with volume attenuation (Audio > Loudspeaker Control)

Adding an External Audio Source

Two inputs are available on the DIS-CCU for adding an external audio source to the system, often useful for teleconferencing or internet calling.

1. Connect a line-level audio source, such as the audio output of a computer, teleconferencing unit, or wireless microphone system to the audio input on the DIS-CCU back panel.
2. Open the web interface to Audio > Input Control .
3. Select the input gain according to the output of the external device. If necessary, select 10 dB for a slight gain boost.
4. Select the routing for the audio channel:
 - **Loudspeaker:** to all microphone unit loudspeakers
 - **Ch. 0:** to the headphone output on the microphone unit
5. If desired, route the channel to Output A (Group) to output a blend of the external source with the microphone units:
 - **Deselect** for teleconferencing or signal processing to avoid a feedback loop
 - **Select** for a microphone to be blended with other discussion unit audio
6. Adjust the volume of the audio input to mix naturally with speech levels at the discussion unit.

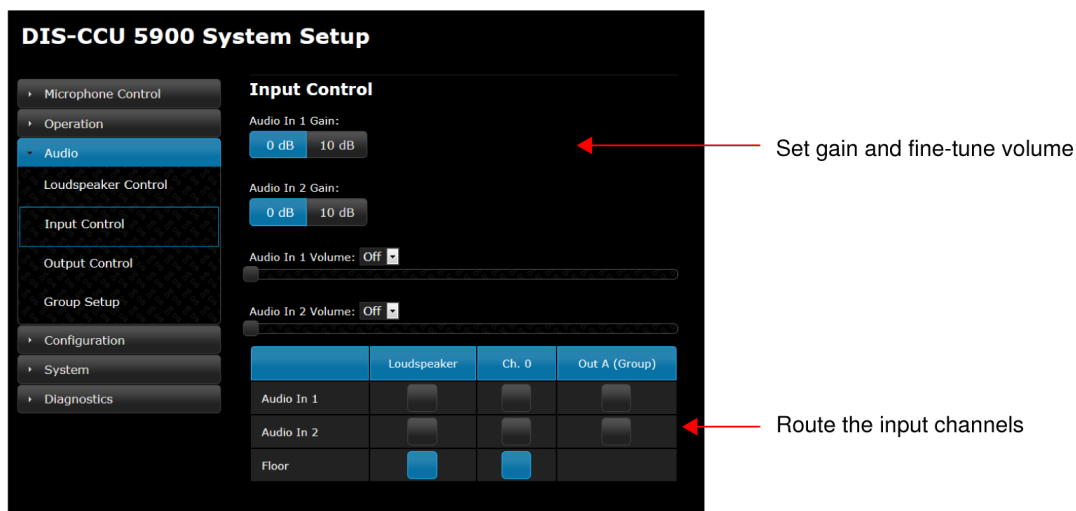

Input Control Page

Emergency Audio Signal

To prepare for an emergency, connect an Emergency Evacuation Message (EEM) audio signal to Input 2. The block connector provides a 'normally-open' switch that when closed, distributes the emergency signal to the loudspeakers and all input and output connections.

Important: When the switch is used for Input 2, the EEM audio signal bypasses the volume and on/off settings. Control the volume of the EEM signal at the source output.

1. Connect the EEM signal to Input 2.
2. Connect a switch to the block connector.
3. Close the switch and test the audio signal. Adjust the volume at the audio source to the desired level.

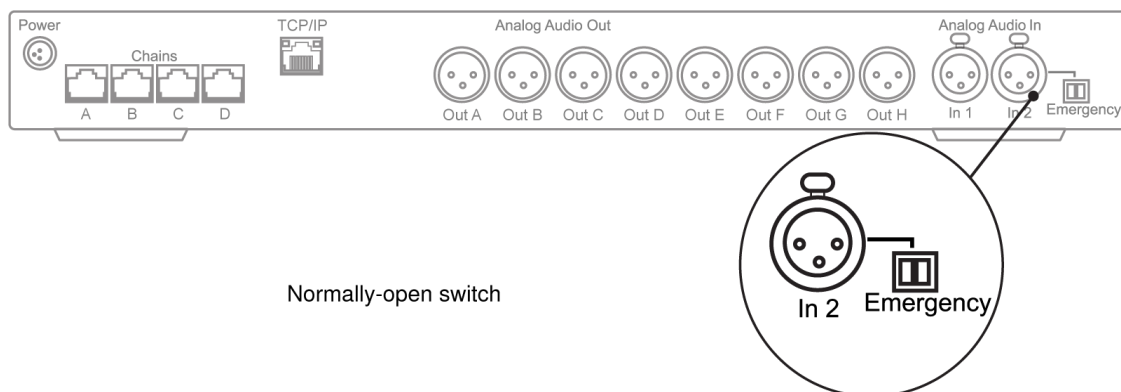

Setting Audio for Meetings or Events

Microphone Operation Modes

The operation mode determines how participant microphones function during a meeting. Several factors may affect the meeting requirements and the manner in which the meeting is run: room size, number of participants, formality of the event, and amount of technical support on staff. The operation mode addresses these factors with four presets to control the microphone behavior.

To change the mode:

- CCU hardware: Delegate Setup > Operation Mode
- Browser interface: Operation > Operation Mode or from the Microphone Control page.

Description of Operation Modes	The following is a description of each mode once the Speak button is pressed:
Auto (Automatic)	Automatically turns on the participant microphone if there is room in the speaker list. In this mode, there is no request queue: if the Speaker List is full, the participant microphone does not turn on.

Description of Operation Modes	The following is a description of each mode once the Speak button is pressed:
Manual	Adds the participant to a request queue that is managed by the chairman. The Chairman selects participant microphones from the queue list, and turns them on and off. Manual is the only mode in which the web browser is required to manage talkers.
FIFO (First In, First Out)	Automatically turns on the participant microphone if there is room in the speaker list. Once the list is full, participants are placed into a chronological request queue. The microphone turns on automatically once a space is open in the speaker list.
VOX (Voice Activation)	The microphone automatically turns on when a participant talks into the microphone or presses the Speak button. The microphone automatically turns off after the talker is finished. In this mode, there is no request queue: if the Speaker List is full, the participant microphone does not turn on.

DIS-CCU 5900 System Setup

Microphone Control

Operation

Operation Mode

Microphone Parameters

Voice Detection

Audio

Configuration

System

Diagnostics

Operation Mode

Operation mode:

Auto

Manual

VOX

FIFO

Speak interrupt mode:

On

Off

SHURE Copyright © 2015 - www.shure.com dis-ccu.local

Speak Interrupt Mode

This mode determines the behavior of the microphone units when the speaker list is full:

- **Off (default):** A participant unit cannot turn on until a space is available in the speaker list.
- **On:** A participant can turn on the microphone even when the speaker list is full. This turns off the microphone of the participant that has been in the list the longest (at the bottom of the Speaker List).

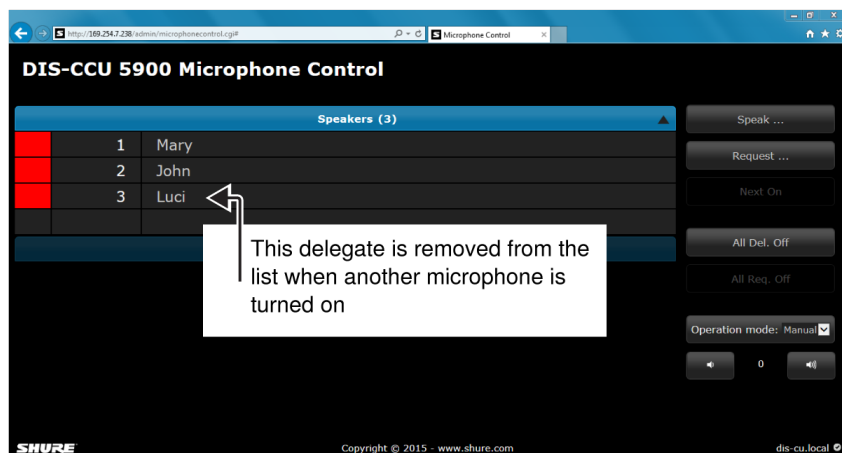

Speaker List with a Maximum of 3 Speakers

When Speak Interrupt is on, a participant that turns on their microphone will override the last person in the speaker list.

Controlling the Discussion Unit

DDS 5900 discussion units are programmable during setup to support the role of each member of a meeting.

Chairman

As the leader of the event, the chairman has several unique features enabled on the discussion unit.

- **All-Delegate Off:** For meeting management, the chairman uses this button to instantly turn off all delegate microphones and clear the Speaker list.
- **Speak:** The chairman can always turn on the microphone, overriding delegate units even when the maximum number of open channels has been exceeded. Therefore, there is no mute button; the chairman simply presses the Speak button to turn the microphone on and off.



Turns off delegate mics



Turns on microphone at any time

Delegate

Delegate units contribute to the main audio mix called the floor mix. The number of simultaneous delegate speakers is limited, requiring different control buttons to participate in the discussion:

- **Speak:** Turns on the microphone or adds the user to the request queue, depending on the system settings. Microphone status displayed by the button LED:
Red = microphone is on

Green = microphone is in the request queue

- **Mute:** Temporarily mutes the audio from the microphone. While the button is pressed, the delegate retains speaking privileges but the microphone will not pass audio to the floor sound.



Temporary audio mute



Activates microphone or sends a request

Interpreter

The primary function of the interpreter unit is to translate the discussion into a foreign language. Participants that do not speak the native language of the discussion rely on the interpreter to participate. Interpreters listen to the floor sound

- **Interpretation Channel Send:** The interpreter selects one of the two channels for transmitting language interpretation.

Interpretation stations can only be assigned to the Portable 5980 P discussion unit.

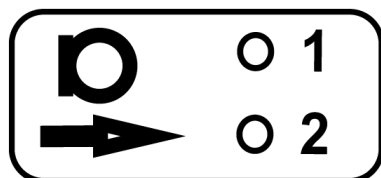

Transmitting channel

Speak Button Settings

Make additional adjustments to the unit speak button from `Operation > Operation Mode`.

Preventing Accidental Microphone Deactivation

Speak Button Lock prevents conflicts that can occur when two people attempt to perform the same action on a unit. The lock temporarily disables the speak button, preventing a participant from overriding an action set by the operator and accidentally turning off their own microphone. Assign a lock duration between 1 - 120 seconds.

Tip: To override the lock, press and hold the speak button for the duration assigned to the Lock Override Time (1 – 120 seconds).

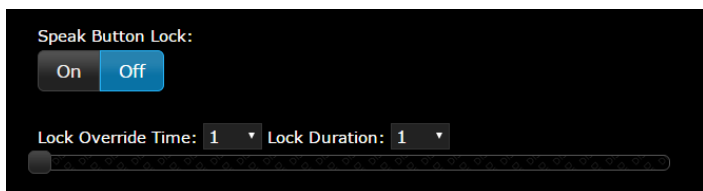

Disabling Microphone Off From the Unit

Allow or prevent participants from turning off their microphones using the speak button on the unit:

- **Allowed:** The participant can turn off the microphone using the speak button on the unit (default setting).
- **Not Allowed:** The microphones can only be turned off by the chairman or operator.

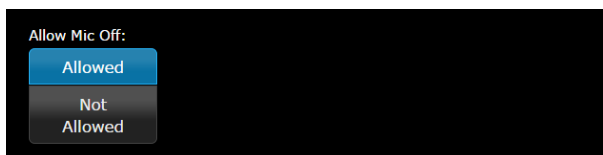

Maximum Speaker Setting

To improve speaker management and clarity of the audio, there is a limit to the number of speakers at the same time. Up to eight chairman and delegate microphones can be open at once. There are several settings:

Note: Interpreter units are always active and do not impact the speaker list.

Max speakers	<ul style="list-style-type: none"> • Total: Total number of open participant and chairman units. This is the absolute maximum number of people that can address the floor at once. • Delegate: Number of delegate microphones that can be open at one time (excludes the chairman).
Maximum Requests	Total number of participants that can be in the request queue at one time.

DIS-CCU 5900 System Setup

Microphone Control

Operation

Operation Mode

Microphone Parameters

Voice Detection

Audio

Configuration

System

Diagnostics

Microphone Parameters

Max speakers: Delegates: 3 Total: 4

Max requests: 58

SHURE

Copyright © 2015 - www.shure.com

shure-ccu-jmi.local

Example Settings

Chairman (Moderator) Can Speak At Any Time

Set the total number of speakers to one (1) higher than the maximum number of participants. If there are two chairmen, set the number to two (2) higher.

Using FIFO Mode

First In, First Out (FIFO) mode automatically turns on microphones based on a chronological queue list. This mode works best if the maximum number of participants is set to one (1), so that the participant must wait to speak until the other is finished.

Voice Detection

Voice Activation (VOX)

In VOX mode, the microphone activates automatically once a participant speaks. The mode is ideal for meetings that are more conversational, allowing back-and-forth communication that doesn't involve speak requests and button activation. The following settings allow VOX to be customized for the meeting:

<p>Voice Detection Threshold</p>	<p>Determines the input level (dB) that activates the microphone. Lower settings activate the microphone with a quieter source, while higher settings require a louder source to activate the microphone.</p> <table border="1" data-bbox="475 905 1497 1125"> <tr> <td data-bbox="475 905 769 978">Default</td> <td data-bbox="769 905 1497 978">0 dB</td> </tr> <tr> <td data-bbox="475 978 769 1052">Minimum</td> <td data-bbox="769 978 1497 1052">-12 dB</td> </tr> <tr> <td data-bbox="475 1052 769 1125">Maximum</td> <td data-bbox="769 1052 1497 1125">8 dB</td> </tr> </table>	Default	0 dB	Minimum	-12 dB	Maximum	8 dB
Default	0 dB						
Minimum	-12 dB						
Maximum	8 dB						
<p>Release Time</p>	<p>Determines how long a microphone remains active after a participant stops talking. The setting is selectable in 0.5 second increments.</p> <table border="1" data-bbox="475 1281 1497 1501"> <tr> <td data-bbox="475 1281 769 1354">Default</td> <td data-bbox="769 1281 1497 1354">4 seconds</td> </tr> <tr> <td data-bbox="475 1354 769 1428">Minimum</td> <td data-bbox="769 1354 1497 1428">1 seconds</td> </tr> <tr> <td data-bbox="475 1428 769 1501">Maximum</td> <td data-bbox="769 1428 1497 1501">10 seconds</td> </tr> </table>	Default	4 seconds	Minimum	1 seconds	Maximum	10 seconds
Default	4 seconds						
Minimum	1 seconds						
Maximum	10 seconds						
<p>Book Drop</p>	<p>To ensure that only the speech from a participant activates the microphone, turn on the book drop feature. This quickly turns off a microphone that has been accidentally activated from a loud noise other than speech.</p>						
<p>Last Mic Stays Open</p>	<p>This setting ensures that at least one microphone is always activated. This is useful for video or audio conferences with echo-canceling equipment.</p>						

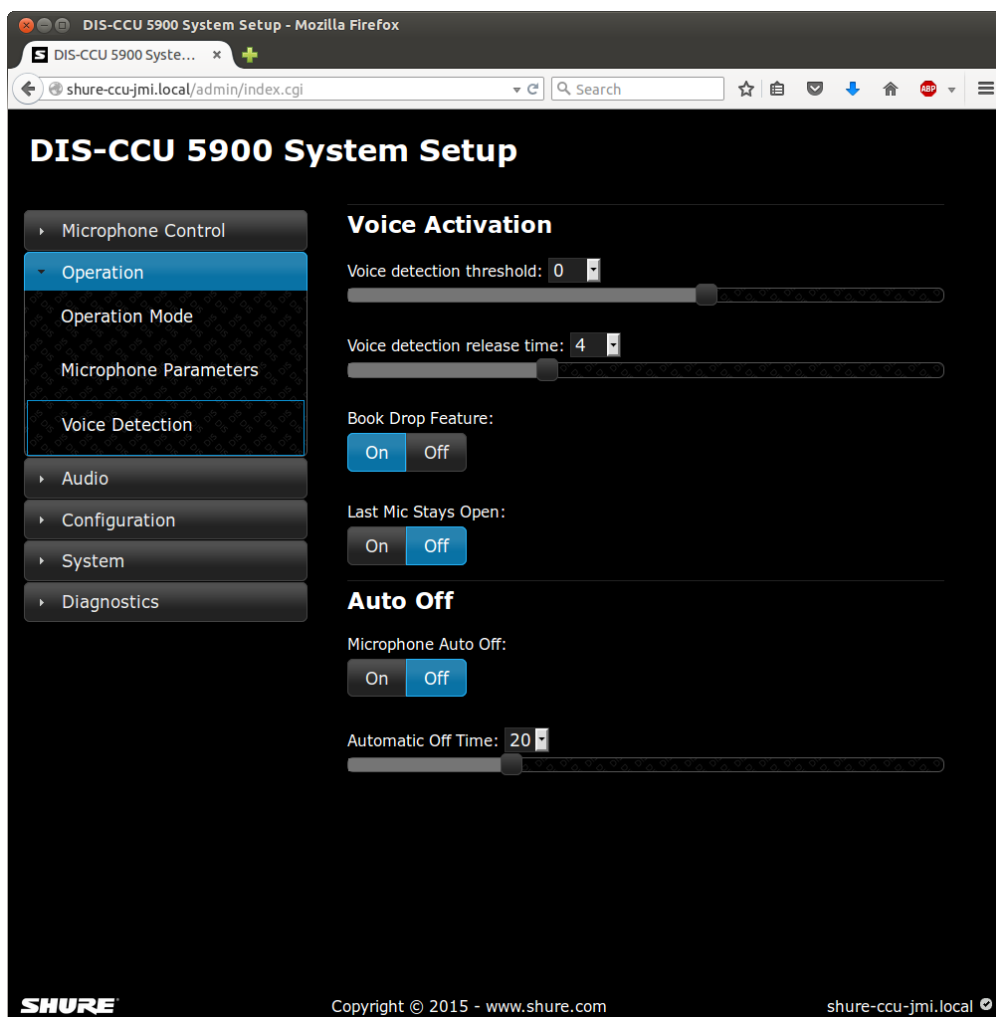

Auto Off

This setting automatically turns off the microphone when the participant stops talking.

- Off (default)
- On

Automatic Off Time	The time for a microphone to turn off after the participant stops speaking.	
	Default	20 seconds
	Minimum	5 seconds
	Maximum	60 seconds

Managing Speakers from the Web Browser

For increased control over the meeting, the chairman uses the browser interface to activate microphones. The chairman page is dedicated for controlling the speaker list and request queue. The chairman can manually turn on/off microphones, or simply monitor the list in an automatic mode. Using the interface, the chairman can easily:

- **Click** on a participant name to turn on the microphone, or add them to the request queue.
- **View** who is speaking and who is waiting their turn to speak



There are two main lists from the Microphone Control page:

Speaker List (Red)	The speaker list displays the name and seat number of each active microphone. The list displays in chronological order, with the most recently activated microphone at the top of the list. A red box turns on next to the seat number for quick visual identification.
Request Queue (Green)	Delegates in this list are next up for speaking. Primarily useful when operating in First In First Out mode (FIFO), the queue chronologically lists all participants that have pressed their speak button. Once an opening is available in the speak list, the participant at the top of the queue list is automatically turned on.

Open the Chairman Page

For access to the chairman page, enter the IP address of the CCU, followed by /chairman (example: <http://172.17.11.137/chairman>).

Controlling Participant Microphones

The following buttons are available to the chairman for controlling the microphones during a meeting:

Speak	Instantly turns on a participant's microphone. Select this button to view all discussion units in the system, including those in the request queue. Select a participant to add them to the Speak list.
Request	Add a participant to the request queue to put them in line for speaking. Select from any participant in the system, excluding the chairman.
Next On	Activates the participant microphone at the top of the request queue. If the maximum speaker count has been reached, the new speaker replaces the last one on the list.
All Del. Off	Turns off all participant units, leaving only the chairman in the speaker list. The same button appears on the chairman discussion unit.

All Req. Off	Removes all participants from the request queue.
--------------	--

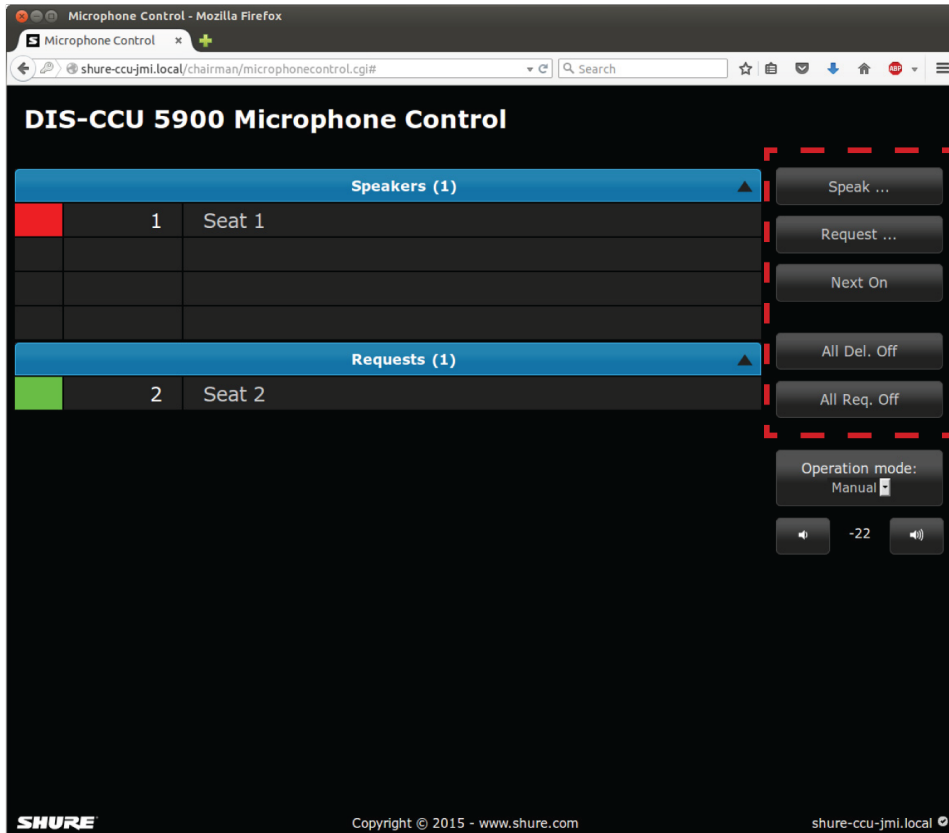

Language Interpretation

There are two additional audio channels used for language interpretation. In bilingual meetings, participants speak their native language into the microphone and listen to the interpretation on headphones.

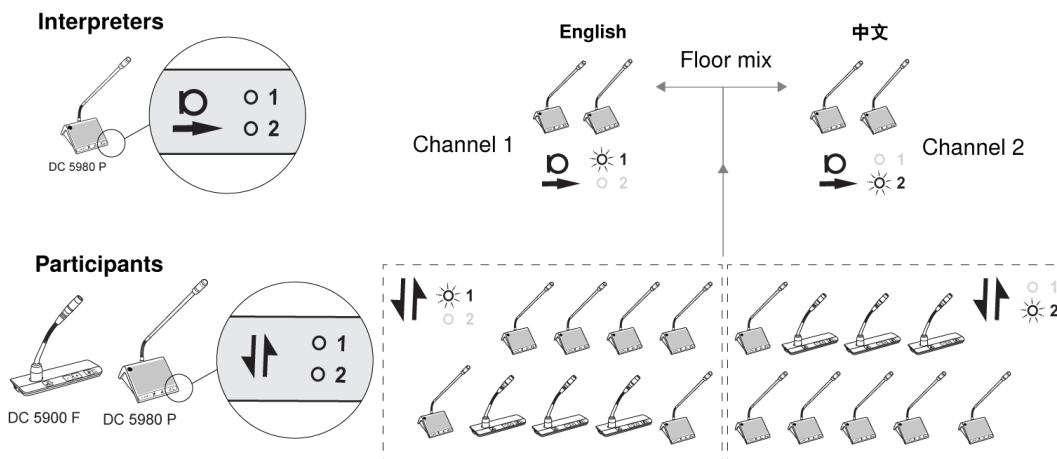

Example Setup for Bilingual Meeting

Interpreters use the portable DC 5980 P to transmit simultaneous language interpretation of the discussion. Participants listen to their desired language channel on any microphone unit with a headphone output.

Set Up Interpretation Channels

1. Begin by programming the portable DC 5980 P as an interpreter station.
 1. Power on the unit by properly connecting it to the DCS-LAN chain.
 2. Press and hold the '-' and '+' volume buttons. The Speak light flashes to indicate the unit is ready for programming.
 3. While continuing to press the volume buttons, press the channel button. Interpreter mode is set when both channel LEDs are illuminated.
2. Select one of the two channels for audio transmission from the interpreter unit. The channel LED will illuminate to indicate the selected channel.

Note: Multiple microphone units can be set for the same interpreter channel to support multiple interpreters at once.
3. Program another DC 5980 P for the second language and select the other channel for transmission.
4. For each participant in the meeting, select the headphone channel that corresponds to the interpreter language. Listen to the interpretation channels on any microphone unit with a headphone output.

Note: Flushmount DC 5900 F units are not programmable as interpreter units.

Troubleshooting

Attention: Always use shielded Cat 5e (or higher) network cables for reliable system operation. Ensure the right cables are used and installed correctly before referencing the troubleshooting table.

<p>The light rings on the microphone are constantly flashing after the system is powered on.</p>	<ul style="list-style-type: none"> • Check that cables are shielded Cat 5e (or higher) • Ensure that all the connectors on all the cables are firmly inserted in the sockets on the units • Check that the feed cables from the microphone units are properly inserted into the 'DCS-LAN' socket on the DIS-CCU.
<p>The 'Del. Off' button on the Chairman Unit does not switch off the Delegate Units</p>	<ul style="list-style-type: none"> • Check to make sure the unit is configured as a Chairman Unit • Check to make sure the other units are not configured as Chairman or Interpreter Units. (See the Program the User Type section.)

<p>The audio from an Interpreter Unit cannot be heard in the headphone of Delegate or Chairman Units</p>	<ul style="list-style-type: none"> • Check to make sure the unit is configured as an Interpreter Unit. (See the Program the User Type section.) • Check the headphone volume control on the units • Check the channel selection on the microphone units • Check that the headphone plug is firmly inserted in the headphone jack • Check that the light ring on the microphone on the Interpreter Unit is illuminated and that the gooseneck microphone is firmly inserted in the socket
<p>There is no audio coming from the built-in loudspeakers</p>	<ul style="list-style-type: none"> • Check the 'Loudspeaker Volume' setting using either the interactive menu on the CCU or using the browser control. • Check that the loudspeaker is set to sufficient volume. (DIS-CCU browser > Audio > Loudspeaker Control .) • Check that the floor mix is assigned to loudspeaker (DIS-CCU browser > Audio > Input Control > Loudspeaker • Check that the seats are selected in 'Group A' (DIS-CCU browser > Audio > Group Setup). 'Group A' is always used as the source for the floor mix. If a unit is not selected in 'Group A', the audio from the unit will not be heard in the built-in loudspeakers.
<p>A microphone cannot be turned 'On'</p>	<ul style="list-style-type: none"> • Check the cables. All cabling for DIS equipment must be Cat 5e or higher with shielded RJ45 cables. • Check the settings Max. Delegate Speaker and Max. Total - Speakers to make sure there is room for another microphone to turn on. • Check the Operation Mode to make sure the mode allows participants to turn on their own microphones.
<p>The DIS-CCU browser application will not open on a PC</p>	<ul style="list-style-type: none"> • Using the interactive menu on the CCU, check the IP address: LAN setup > Acquire IP address . Use this IP address using the browser • Verify that the CCU and the PC are connected to the same network • Check the LAN cable connections

<p>The DIS-CCU browser application will not open on a tablet or laptop</p>	<ul style="list-style-type: none"> • Using the interactive menu on the CCU, check the IP address: LAN setup > Acquire IP address . Use this IP address using the browser • Verify that the tablet or laptop is connected to the proper wireless access point • Check that the DIS-CCU is connected to the same subnet as the wireless access point
--	--

Factory Default Reset

<p>From the Hardware</p>	<p>This will revert the unit to factory settings, erasing all participant, system and IP settings. The unit will reboot in 5900 mode.</p> <ol style="list-style-type: none"> 1. Go to the front panel of the CCU. 2. Scroll the main menu to Restore factory def.. Press the center button to enter menu. 3. Press the center button to select OK and confirm the reset. 4. Wait for the system to reboot. The computer will lose connection to the browser interface during this time.
<p>From the Browser Interface</p>	<p>This will erase all participant and system settings.</p> <ol style="list-style-type: none"> 1. Open the CCU browser interface 2. Go to System > Factory Defaults 3. Select the Reset button to reset the system. 4. Wait for the system to reboot. The computer will lose connection to the browser interface during this time.

Diagnostic Report

To assist in troubleshooting, a system-wide report is available from the moment the CCU powers on.

1. Go to Diagnostics > Report
2. Select Generate to view the report in a new window.
3. Save the file as an HTML document and mail it to the Shure support group to diagnose the issue.

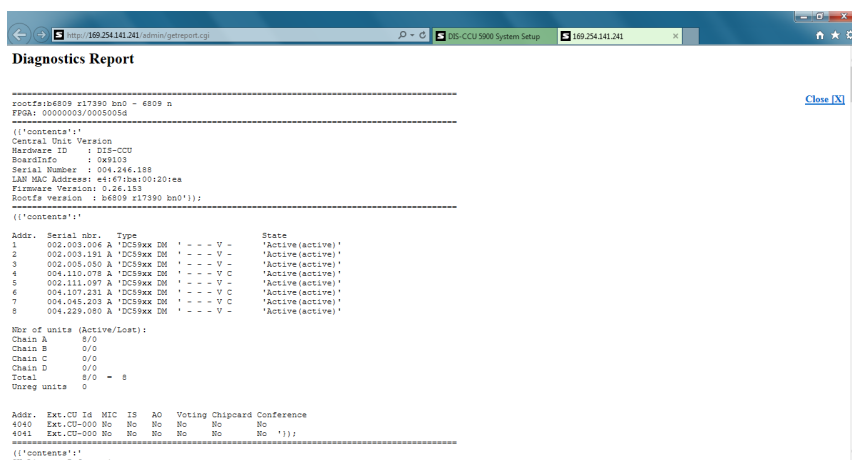

Generated System Report

Firmware Update

Use the Firmware Update Utility (FUU) to update the system firmware.

1. Make sure the system is on and operating properly.
2. Download the latest firmware from the Shure website. The FUU is bundled with the firmware download.
3. Install the application and save the firmware folder to the computer.
4. Launch the application.
5. Select the proper firmware library for the equipment.
 1. Close the missing dialog box
 2. Navigate to the FUU library (FUU_upgrade_library)
 3. Select the open button to use this folder.
6. Assign the connection method for the computer and equipment and select the OK button to exit the setup window:
 - **Ethernet:** Type the IP address of the CCU and use IP port 3142.
7. Information about the CCU and all connected units display in the main window.
8. Select the desired firmware release (typically the highest/latest) in the Selected Release Id drop-down list.
9. Select the Upgrade System button to begin the firmware update process. A status window will appear and show the progress of the firmware upgrade.

External Control Protocol

The DIS-CCU features an Ethernet connection for the purpose of providing an interface to control and monitor the system. By setting up a simple (raw) TCP/IP socket connection to the DIS-CCU Central Unit, control options are available.

This section describes the TCP/IP raw socket protocol for communicating with the DDS 5900 Discussion System. This protocol provides a short set of commands, enabling a third-party control application to monitor and/or control system status of a DDS 5900 Discussion System.

Some examples of functionality available using the protocol:

- Setting a microphone in speak or in request
- Retrieving a list of seats available in the system.

This interface supports applications developed by customers, so the protocol is deliberately kept simple. The External Control protocol offers a means for supplementing the control functionality available through the DDS 5900 Browser interface and the DIS-CCU interactive display, however some commands and settings available in the browser interface and on the DIS-CCU interactive display are not available using the 'External Control Protocol'

Customer applications can include but are not limited to AMX[®] or Crestron[®] room control systems, PC or micro controller based applications, e.g., for button mimics and camera control applications.

General Protocol Behavior

TCP/IP socket connection

A TCP/IP socket connection to the DIS-CCU must be established for the External Control protocol to become available. Configuration of the DIS-CCU connection to the Ethernet must be defined from the CCU interactive front plate control/Browser interface and an IP address for the DIS-CCU must be assigned in the network.

Choose either a static IP address or an IP address assigned through DHCP. It is convenient to ensure, that the DIS-CCU ends up with the same IP address at each start up.

Knowing the IP address, the only additional information required for setting up a TCP/IP connection is the Port Number:

Port Number = 3142

Example: Test connection to CCU via Putty[®]: If the DIS-CCU is assigned IP address 192.168.1.100, the external application must connect the TCP/IP socket to the address 192.168.1.100:3142.

Knowing the IP address of the DIS-CCU a connection can be set up using a simple terminal program like Putty.

1. Download at <http://www.putty.org> (<http://www.putty.org>)
2. Start Putty.
3. Insert IP address and Port Number.
4. Select 'Raw' for the Connection Type.
5. Press 'Open' to establish connection to the CU. Control is now possible.
6. Type 'help' to see a list of commands available.

Command Structure (from External Control to DIS-CCU)

To control the CCU an External Control sends commands to DIS-CCU included in command lines. Command lines are build up in a very simple manner:

```
<command><SP><data><CR>  
<command><SP><data><LF>
```

```
<SP> Space - 0x20 = 32  
<CR> Carriage return - 0x0D = 13  
<LF> Line Feed - 0x0A = 10
```

Command lines are terminated by a Carriage Return <CR> or Line Feed <LF> or both. In order to be able to communicate with Windows systems, Linux systems or other systems, the CCU understands both types of command line terminations.

Notice also, there is a space between the command and data. If a command does not carry any data, space is possible but not required.

The CCU is not sensitive to upper/lower case.

Example:

```
mic_on 212<CR>
```

Turn on microphone at seat 212. Command = mic_on, data = 212. The 'mic_on' command carries a seat number as data.

Command Structure (from DIS-CCU to External Control)

Command lines out of the DIS-CCU are just as simple:

```
<command><SP><data><CR><LF>
```

```
<SP> Space - 0x20 = 32  
<CR> Carriage return - 0x0D = 13  
<LF> Line Feed - 0x0A = 10
```

Again, to satisfy most systems, the CCU terminates command lines by including both <CR> and <LF>.

Seat Numbering

Discussion Units are identified by means of a seat numbers. Each Discussion Unit is assigned a seat number. This is done automatically for all discussion units, when they are connected to the DIS-CCU. The DIS-CCU Browser interface is used to change seat numbering.

Seat numbers must be in the range from 1 to 65535.

DIS-CCU Reply to Commands

Generally, a command from an external application is replied to by the CU. But, reply to a command is produced only if actions are taken by the CCU due to the command.

Example: When a 'mic_on' command results in a microphone being turned on, the CCU replies with a 'mic_on' command. On the other hand, if a 'mic_on' command does not lead to turning on a microphone, the CCU does not produce any reply.

There can be several reasons for the CCU to reject turning on a microphone:

- The microphone is already on
- The microphone is no longer connected to the system
- Speak list is already full ('max_speakers') and delegate interrupt is not 'on'

Retrieving System Status

The CCU supports streaming of status. When an External Control issues a 'mic_status' or 'audio_status' command, the CCU responds by sending the microphone system status. The same applies to 'audio status'. Therefore, it is possible for an External Control to synchronize with the CCU status.

Microphone Control

Commands from External Control to DIS-CCU

Turn on microphone

```
mic_on <seat no><CR>
```

Instruct the CCU to turn on the microphone at seat_no.

If the CCU turns on the microphone, it replies with the '**mic_on**' command. If the microphone also appeared in the request list, it is taken out of the request list and the CCU issues the '**mic_request_off**' command.

Turn off microphone

```
mic_off <seat no><CR>
```

Instruct the CCU to turn off the microphone at seat_no.

If the CCU turns off the microphone, it issues a '**mic_off**' command.

Turn off all the delegate microphones

```
mic_all_delegates_off<CR>
```

Instruct the CCU to turn off all delegate microphones.

A Chairman is not turned off.

The CCU responds to the command by issuing the '**mic_off**' command for each microphone that is turned off.

Put a microphone in the request list

```
mic_request_on <seat no><CR>
```

Insert a microphone into the request list.

The CCU inserts the unit into the request list and it issues the '**mic_request_on**' command.

Remove a microphone from the request list

```
mic_request_off <seat no><CR>
```

Remove a microphone from the request list.

The CCU removes the unit from the request list and it issues the '**mic_request_off**' command.

Clear the request list

```
mic_all_requests_off<CR>
```

Clear the request list.

The CCU responds by issuing the '**mic_request_off**' command for each microphone that is removed from the request list.

Set the next microphone on

```
mic_next_on<CR>
```

Turns off the first microphone in the speak list and turns on the first microphone from the request list.

If a microphone is turned off, the CCU issues the '**mic_off**' command.

If a microphone is turned on, the CCU issues the '**mic_on**' command and the '**mic_request_off**' command.

Set the maximum number of total speakers

```
max_total_speakers <max total speakers><CR>
```

Maximum number of speakers allowed to speak.

<max total speakers> Can be set from "1" to "8"

The CCU issues the '**max_total_speakers**' command.

Set the maximum number of delegate speakers

```
max_speakers <max speakers><CR>
```

Maximum number of delegates allowed to speak.

<max speakers> Can be set from "1" to "8"

The CCU issues the '**max_speakers**' command.

Set the maximum number of requests

```
max_requests <max requests><CR>
```

Maximum number of delegates allowed in the request list.

<max requests> Can be set from "0" to "250".

The CCU issues the '**max_requests**' command.

Set the Operation Mode

```
mic_mode <mode><CR>
```

Set the system operation mode.

<mode> Can be set to "auto" (Automatic), "fifo" (First-in-first-out), "manual" (Manual) or "vox" (Voice Active)

The CCU issues the '**mic_mode**' command.

Set the Interrupt Mode

```
mic_interrupt <mode><CR>
```

Set the ability to interrupt. Defines, whether microphones should interrupt or not.

<mode> Can be "on" (microphones interrupt) or "off" (microphones do not interrupt)

The CCU issues the '**mic_interrupt**' command

Retrieve the Microphone Status

```
mic_status<CR>
```

Ask the CCU to deliver status of the system (microphones in speak, and microphones in request list).

The CCU issues the microphone system status. The status is a list of commands from the CU:

seat_number (for all microphones in the system)

mic_mode

mic_interrupt

max_total_speakers

max_speakers

max_requests

mic_on (for all microphones on)

mic_request_on (for all microphones in request list)

mic_status_done

Help

help<CR>

help <command><CR>

Help is available for all commands supported by the CU. If a command is included after the help command, details on that command is issued by the CU.

The help command results in a brief description of the command being issued by the CU. This command is intended for use on a simple console.

Commands from DIS-CCU to External Control

Microphone On

mic_on <seat no><CR>

A microphone is turned on.

Microphone Off

mic_off <seat no><CR>

A microphone is turned off.

Microphone into Request List

mic_request_on <seat no> <request position><CR>

A microphone is inserted into the request list.

<request position> provides information about the position in the request list.

Microphone out of Request List

mic_request_off <seat no><CR>

A microphone is removed from request list.

Max Total Speakers

max_total_speakers <max total speakers><CR>

Maximum number of speakers allowed to speak.

<max total speakers> "1" to "8"

Max Delegate Speakers

max_speakers <max speakers><CR>

Maximum number of delegates allowed to speak.

<max speakers> "1" to "8"

Max Requests

max_requests <max requests><CR>

Maximum number of delegates allowed in the request list.

<max requests> "0" to "250".

Operation Mode

mic_mode <mode><CR>

Provides system operation mode.

<mode> "auto" (Automatic), "fifo" (First-in-first-out), "manual" (Manual) or "vox" (Voice Active)

Interrupt Mode

mic_interrupt <mode><CR>

Ability for microphones to interrupt.

<mode> "on" (microphones interrupt) or "off" (microphones do not interrupt)

Seat State

seat_state <seat number> <seat state> <seat name><CR>

Provides seat information.

This information is sent from the CCU to an External Control, when the External Control requests microphone status (**mic_status**).

<seat number> The seat number identification of a Discussion Unit. An number from 1 to 65535.

<seat state> The current state of the seat. This is either "active" or "passive"

<seat name> Name assigned to a Discussion Unit via the browser interface.

Example:

```
seat_state 12 active Sharon Hall
mic_mode auto
mic_interrupt off
max_total_speakers 4
max_speakers 3
max_requests 250
mic_status_done
```

This command informs about seat number 12, which is active and has the name Sharon Hall attached.

Microphone Status Complete

mic_status_done<CR>

Provides notification that complete system status has been sent.

Seat State

seat_state <seat number> <seat state><CR>

Provides seat state information.

This information is sent from the CCU to an External Control, when the state of a seat changes – a seat becomes passive or active.

<seat number> The seat number identification of a discussion unit. An integer ranging from 1 to 65535.

< seat state > The current state of the seat. This can be "active" or "passive"

Command error

command_error <error text><CR>

The CCU has received an unknown command.

<error text> is a text explaining the error.

Examples:

command_error unknown command<CR>

command_error syntax error<CR>

Audio Control

Commands from External Control to DIS-CCU

Set Loudspeaker Volume

loudspeaker_volume <volume><CR>

Sets the volume of the loudspeakers for all Discussion Units.

<volume> The volume of the loudspeakers ranges from -41 to 0. The value -41 indicates the speaker is Off. Values from -40 to 0 indicates the attenuation in dB.

The CCU responds to this command by issuing the loudspeaker_volume command.

Set Line Input 1 Gain

line_input_gain_1 <gain><CR>

Adjusts the level of the line input 1 signal.

<gain> Adjust line input gain to 0 or 10 dB.

The CCU responds to this command by issuing the `line_input_gain_1` command.

Set Line Output Volume (A-D)

```
line_output_volume <output> <volume><CR>
```

Adjusts the level of the line output signal.

<output> Indicates which output is being controlled. Possible values are: 'A', 'B', 'C' or 'D'.

<volume> The volume of the line output ranges from -41 to 0. The value -41 indicates the volume is Off. Values from -40 to 0 indicate attenuation in dB.

The CCU responds to this command by issuing the `line_output_volume` command.

Define Audio Path

```
audio_path <path> <on/off><CR>
```

This command defines audio connections in the system.

<path> Indicates which connection is being controlled. Possible values are: 'mic_to_speaker', 'mic_to_floor', 'linein_1_to_speaker', 'linein_1_to_lineout_A' or 'linein_1_to_floor'.

<on/off> Indicates whether the audio is being routed from microphones/lineinput_1 to speakers/lineoutput/floor.

The CCU responds to this command by issuing the `audio_path` command.

Request Audio Status

```
audio_status<CR>
```

Provides system audio status.

The CCU responds to this command by issuing a list of commands for the Audio settings:

```
loudspeaker_volume
```

```
line_output_volume (for all outputs A-D)
```

```
audio_path (for all paths)
```

```
line_input_level
```

```
audio_status_done
```

Commands from DIS-CCU to External Control

Loudspeaker Volume

```
loudspeaker_volume <volume><CR>
```

Indicates the volume of loudspeakers for all Discussion Units.

<volume> The volume of the loudspeakers ranges from -41 to 0. The value -41 indicates the volume is Off. Values from -40 to 0 indicate attenuation in dB.

Line Input 1 Gain

line_input_gain_1 <gain><CR>

Indicates the gain of the line input 1 signal.

<gain> Adjust line input gain to 0 or 10 dB

Line Output Level (A-D)

line_output_level <output> <level><CR>

Adjusts the level of the line output signal.

<output> Indicates which output is being controlled. Possible values are: 'A', 'B', 'C' or 'D'.

<level> The level of the line output ranges from -41 to 0. The value -41 indicates the output is zero. Values from -40 to 0 indicate attenuation in dB.

Define Audio Path

audio_path <path> <on/off><CR>

This command defines audio connections in the system.

<path> Indicates which connection is being controlled. Possible values are: 'mic_to_speaker', 'mic_to_floor', 'linein_1_to_speaker', 'linein_1_to_lineout_A' or 'linein_1_to_floor'.

<on/off> Indicates whether the audio is being routed from microphones/lineinput_1 to speakers/lineoutput_A/floor.

Audio Status Complete

audio_status_done<CR>

This command terminates audio status streaming.

Technical Specifications

DDS 5900 System

The microphone system conforms to IEC 60914, the international standard for discussion systems. However the functionality of an Interpreter Unit differs from the standard.

Audio performance specifications are measured from the audio input of a Discussion Unit to the headphone output of a Discussion Unit.

System Audio Performance

Audio quality	24 bit audio @ 32 kHz sampling frequency
Audio frequency response	65 Hz - 16 kHz (-3 dB)
Total harmonic distortion at 1 kHz	< 0.1%
Dynamic range	> 80 dB
Weighted signal-to-noise ratio	> 85 dB(A)

Cabling and System Limits

Cable type (min. specification)	Cat5e, AWG 24, screened, shielded
Maximum cable length	<ul style="list-style-type: none"> • CU only: 120 m • With repeater units: 480 m

System Environmental Conditions

Working condition	Fixed, stationary or transportable
-------------------	------------------------------------

Temperature Range

To guarantee specified performance	5 Deg C. to 40 Deg C.
Storage temperature	-20 Deg C. to 60 Deg C
Maximum relative humidity	< 80%

Approvals

EMC emission	According to harmonized standard EN 55103-1 and FCC rules part 15, complying with the limits for a class B digital devices
EMC immunity	According to harmonized standard EN 55103-2

EMC approvals	Affixed with the CE mark
ESD	According to harmonized standard EN 55103-2
Mains harmonics	According to harmonized standard EN 55103-1
Environmental requirements	Contains no banned substances as specified in UAT-0480/100 (e.g. no cadmium or asbestos)

DIS-CCU

The following table provides maximum number unit and channel counts per DDS 5900 system.

Max. number of discussion units	250
Number of discussion units powered by DIS-CCU	up to 50
Max. number of open "floor" microphones	8
Max. number of languages (interpreter channels)	2
Max. number of interpreter units	32

Network

DCS-LAN outputs	Four (4) RJ45 female sockets
TCP/IP	One (1) RJ45 female sockets

Audio

Audio inputs

Analog Inputs	Two (2) 3-pin female XLR sockets (electronically balanced)
Emergency input - EEM	Configurable on Input 2, with contact closure

Nominal input level	switchable: <ul style="list-style-type: none"> • 0 dBm (0.775V RMS) • -10 dBm (0.245V RMS)
Max. input level	+15 dBm (4.5V RMS)
Input Impedance	50-100 k Ω

Audio outputs

Analog audio out	Eight (8) 3-pin male XLR sockets (electronically balanced)
Maximum load	> 1 k ohm
Nominal output level	0 dBm at nominal input
Max. output level	4.9V RMS ~ +16 dBm

Electrical

Power consumption	22W/48V (150W max.)
Supply voltage for discussion units	122W/48V
Sound quality	24 bit audio, 32 kHz sampling frequency
Frequency response	65 Hz-16 kHz
THD	< 0.1 %
Signal-to-noise ratio	> 85 dBA

Mechanical

Mounting	<ul style="list-style-type: none"> • tabletop • standard 19" rack
Dimensions (H x W x D)	44.4 x 426 x 186 mm (1.75 x 16.8 x 7.2 in.)

Color	Black
Weight	2.8 kg (6.17 lbs.)
Temperature range	Storage: -20° to 60° C, 10-80% humidity Operation: 5° to 40° C, 35-80% humidity

PS-CCU External Power Supply (SNP-A15T):

Main voltage	100-240 V, 50-60 Hz nominal
Max. consumption	175 W
Total supply power	144 W (power factor: >0.9)
Standby consumption	<0.5 W (no load)
Supply voltage	48V/3A @ 40°C ^[1]
Efficiency	87%, typical
Inrush Current	<ul style="list-style-type: none"> • 230 V: <80 A • 115 V: <40 A

[1] De-rate linearly to 50% @ 60°C



Certifications

The DCS 6000 system conforms to standard IEC 60914.

Electrical

Frequency response (headphone)	65 Hz-16 kHz
Frequency range (loudspeaker)	150 Hz-15 kHz
Power consumption	1.5 W

Power maximum (loudspeaker)	2.1 W RMS
THD	< 0.1 %
Signal-to-noise ratio	> 85 dBA
Headphone connection	3.5 mm jack, female stereo socket

Interconnections

DCS-LAN	Two RJ45 female sockets with auto-termination
---------	---

Mechanical

Mounting	Tabletop
Dimensions (H x W x D)	71 x 128 x 146 mm (2.8 x 5.0 x 5.75 in.)
Weight	500 g (1.1 lbs.)
Color	Black
Temperature range	5° to 40° C

Electrical

Frequency response (headphone)	65 Hz to 16 kHz
Frequency response (loudspeaker)	150 Hz to 15 kHz
Power consumption	1.5 W
Power maximum (loudspeaker)	2.1 W RMS
THD	<0.1%
Signal-to-noise ratio	>85 dBA
Headphone connection	3.5 mm jack, female stereo socket

Interconnections

DCS-LAN	Two RJ45 female sockets (loop-through) with auto-termination
Headphone	3.5 mm stereo jack
Loudspeaker	2-pin 2.5 mm pitch Spox™ Molex socket

Mechanical

Mounting	Flush mounted
Dimensions (H x W x D)	<p>DC 5900 F Base: 50 x 50 x 106 mm</p> <p>LS 5900 F: 44 x 108 x 78 mm</p> <p>FP 5921 F: 12 x 73 x 63 mm</p> <p>FP 5981 F: 12 x 152 x 63 mm</p> <p>AC 5901: 47 x 19 x 19 mm</p>
Color	Black
Weight	<p>DC 5900 F Base: 188 g</p> <p>LS 5900 F: 260 g</p> <p>FP 5921 F: 38 g</p> <p>FP 5981 F: 79 g</p> <p>AC 5901: 43 g</p>
Temperature range	5° to 40° C

Gooseneck Microphones

GM 59xx

System	<ul style="list-style-type: none"> • DC 5900 F • DC 5900 P
--------	--

Transducer type	Condenser
Polar pattern	Cardioid
Frequency response	30 Hz - 18 kHz
Sensitivity	-52 +/- 3dB (0dB = 1V/1Pa, 1 kHz)
Maximum input sound level	110 dB SPL, 1 kHz at 3% THD
Signal-to-noise ratio	>60 dBA
Front/back ratio	>25 dB (1 kHz)
Dimension (GM 5923)	400 mm (15.75 in.)
Dimension (GM 5924)	500 mm (19.7 in.)
Microphone connector	XLR3 male

MX4xx

System	DC 5900 F
Transducer type	Condenser
Polar pattern	Cardioid, Supercardioid
Frequency response	50 Hz - 18 kHz
Sensitivity	Cardioid: -35 dBV/Pa (18 mV) Supercardioid: -34 dBV/Pa (21 mV) (0dB = 1V/1Pa, 1 kHz)
Maximum input sound level	Cardioid: 121 dB Supercardioid: 120 dB 1 kHz at 1% THD, 1 kΩ load
Signal-to-noise ratio	Cardioid: 66 dB Supercardioid: 68 dB

Dimension	MX 405: 15 cm (6 in.) MX 410: 25 cm (10 in.) MX 415: 38 cm (15 in.)
Weight	MX405: 0.054 kg (0.119 lbs) MX410: 0.068 kg (0.150 lbs) MX415: 0.07 kg (0.154 lbs)
Microphone connector	XLR3 male

Wiring Details

Main Power

Blue	Neutral
Brown	Live
Green/Yellow	Earth (Ground)

DCS-LAN Chain

The DIS-CCU uses Cat5e, Cat6 or Cat7 F/UTP or U/FTP cables with shielded RJ45 connectors.

EIA 568-B wiring must be used.

Important: The names of Cat5/6/7 cable type have changed.

Old Name	New Name
FTP	F/UTP
STP	U/FTP
UTP	U/UTP

Important: Use only F/UTP or U/FTP (screened) cables and screened RJ45 connectors and not U/UTP cable, which is unshielded.

How to wire a Cat5e (EIA 568-B) cable to a RJ45 con.:

Pin	Function	Connector #1	Connector #2
1	In-going +	ORG/WHT	ORG/WHT
2	In-going -	ORG	ORG
3	+48V	GRN/WHT	GRN/WHT
4	0V	BLU	BLU
5	0V	BLU/WHT	BLU/WHT
6	+48V	GRN	GRN
7	Outgoing -	BRN/WHT	BRN/WHT
8	Outgoing +	BRN	BRN

If other color codes are used then the four pairs are connected as follows:

Pair 2: Pin 1 & 2

Pair 3: Pin 3 & 6

Pair 1: Pin 4 & 5

Pair 4: Pin 7 & 8

The phase of the pairs must be correct and the wiring specification EIA 568-B (Cat5e).

Cat6 and Cat7 cables are normally only be terminated in sockets (female) and not in cable plugs.

Cat6 and Cat7 can only be used for feeding cables terminating in wall outlets or patch panels.

Analog Audio Out

XLR3 male

Pin	Signal	Cable type
1	Earth	2 x 0.25 mm ² shielded.
2	Signal +	
3	Signal –	

Analog Audio In

XLR3 female

Pin	Signal	Cable type
1	Earth	2 x 0.25 mm ² shielded.
2	Signal +	
3	Signal –	



Emergency switch

Terminal block

Connect the emergency switch to pin 1 and 2.



Earphones

3.5 mm Jack plug

Pin	Connector	Function
1	Tip	Signal left
2	Ring	Signal Right
3	Sleeve	Electrical earth/screen



How To Order

DIS-CCU

Central control unit for the DIS lines of discussion and conferencing systems. Operates with the DDS 5900 system as shipped, and is upgradeable for the DCS 6000 system with a feature license. Includes a web interface for system configuration, microphone control, and displaying the speaker list during the meeting.

Include accessories:

- Terminal block for EEM connector
- 19" rack brackets

- USB memory stick with user manuals
- Tool for securing the GM gooseneck microphone in DDS 5900 and DCS 6000 portable units

DIS-CCU Variations

Central control unit, without power supply	DIS-CCU
Central control unit, with power supply for Europe	DIS-CCU-E
Central control unit, with power supply for UK	DIS-CCU-UK
Central control unit, with power supply for U.S.	DIS-CCU-US
Central control unit, with power supply for Argentina	DIS-CCU-AR
Central control unit, with power supply for Brazil	DIS-CCU-BR

PS-CCU Power Supply

Power supply for the DIS-CCU and DCS-LAN power kits and inserters.

PS-CCU Model Variations

Model	Region
PS-CCU-US	US
PS-CCU-AR	Argentina
PS-CCU-AZ	Australia
PS-CCU-BR	Brazil
PS-CCU-CHN	China
PS-CCU-E	Europe
PS-CCU-IN	India
PS-CCU-J	Japan
PS-CCU-K	Korea
PS-CCU-TW	Taiwan

Model	Region
PS-CCU-UK	UK

Portable discussion unit for DDS 5900. Integrated loudspeaker, headphone jack and channel selectors. Includes delegate button overlay with mute. Configurable as chairman, participant, or interpreter.	DC 5980 P
Button overlay for DC 5980 P: Delegate, with mic on/off (10 units)	DC 5980 P ACC-DM
Button overlay pack for DC 5980 P: chairman overlays (2 units) and interpreter station (3 units)	DC5980P-ACC-CM-IS
AC 5900 Cable Clamps; pack of 20 units	AC 5900 CC 20PK
Spare Part Set DDS 5900 P	SPS DDS 5900 P

Base unit for DC 5900 F Discussion unit.	DC 5900 F
Loudspeaker for use with DC 5900 F	LS 5900 F
XLR/Microflex Adapter (5 pack)	AC 5901 5PK
Spare Part Set DDS 5900 F	SPS DDS 5900 F

DC 5900 F front plate without headphone jack or channel selectors. Configurable as chairman or delegate. (Button overlays not included.)	FP 5921 F
DC 5900 F Overlay: Delegate with mute button (5 pack)	FP 5921 OL1 5PK
DC 5900 F Overlay: Delegate (5 pack)	FP 5921 OL2 5PK
DC 5900 F Overlay: Chairman with all-delegate off button (2 pack)	FP 5921 OL3 2PK
DC 5900 F Overlay: no buttons (5 pack; Chairman & Delegate)	FP 5921 OL4 5PK

DC 5900 F front plate with headphone jack and channel selectors. Configurable as chairman or delegate. (Button overlays not included)	FP 5981 F
DC 5900 F Overlay: Delegate with mute and channel selector buttons (5 pack)	FP 5981 OL5 5PK
DC 5900 F Overlay: Delegate with channel selector buttons (5 pack)	FP 5981 OL6 5PK

DC 5900 F Overlay: Chairman with all delegate-off button and channel selector buttons (2 pack)	FP 5981 OL7 2PK
--	-----------------

Microphones

Gooseneck microphone, 40 cm. Black with LED.	GM 5923
Gooseneck microphone, 50 cm. Black with LED.	GM 5924

Pre-Tested Shure Cables

Shure offers individually-tested cables for Shure conferencing and discussion equipment. The EC 6001 are high-quality, shielded Cat5e cables available various lengths from 0.5 m to 100 m. Made with male-to-male shielded connectors.

Male-to-Male Patch Cables

0.5 m black shielded Cat5e F/UTP cable (shielded RJ45)	EC 6001-0.5
1 m black shielded Cat5e F/UTP cable (shielded RJ45)	EC 6001-01
2 m black shielded Cat5e F/UTP cable (shielded RJ45)	EC 6001-02
3 m black shielded Cat5e F/UTP cable (shielded RJ45)	EC 6001-03
5 m black shielded Cat5e F/UTP cable (shielded RJ45)	EC 6001-05
10 m black shielded Cat5e F/UTP cable (shielded RJ45)	EC 6001-10
20 m black shielded Cat5e F/UTP cable (shielded RJ45)	EC 6001-20
30 m black shielded Cat5e F/UTP cable (shielded RJ45)	EC 6001-30
50 m black shielded Cat5e F/UTP cable (shielded RJ45)	EC 6001-50
100 m black shielded Cat5e F/UTP cable (shielded RJ45)	EC 6001-100

Advanced Setup

Distribution box with 4 outputs. DCS 6000 and DDS 5900 systems	JB 6104
DCS-LAN extension unit for additional 160 conference units	EX 6010
Inline data repeater for DCS-LAN network; 1 input x 4 outputs	RP 6004
Inline power supply for up to 40 additional discussion units. See table for regional variations.	PI-6001

Inline Power Supply Kit

Model	Region
PI-6001	No power supply
PI-6000-US	US
PI-6000-AR	Argentina
PI-6000-BR	Brazil
PI-6000-E	Europe
PI-6000-UK	UK

Storage

Storage box for ten units of DC 5980 P and GM 59xx	SB 5980
--	---------

Spare Parts

Spare Part Set DDS 5900 F	SPS DDS 5900 F
Spare Part Set DDS 5900 P	SPS DDS 5900 P
Spare Part Set DDS 5900 P	SPS DDS 5900 P
AC 5900 Cable Clamps; pack of 20 units	AC 5900 CC 20PK

Certifications

This product meets the Essential Requirements of all relevant European directives and is eligible for CE marking.

The CE Declaration of Conformity can be obtained from: www.shure.com/europe/compliance

Authorized European representative:

Shure Europe GmbH

Headquarters Europe, Middle East & Africa

Department: EMEA Approval

Jakob-Dieffenbacher-Str. 12

75031 Eppingen, Germany

Phone: +49-7262-92 49 0

Fax: +49-7262-92 49 11 4

Email: info@shure.de

Important

Important Safeguards

1. **Read these instructions** - All the safety and operating instructions should be read before the apparatus or system is operated.
2. **Keep these instructions** - The important safety instructions and operating instructions should be retained for future reference.
3. **Follow all warnings** - All warnings on the apparatus and in the operating instructions should be adhered to.
4. **Follow all instructions** - All instructions for installation or use/operating should be followed.
5. **Do not use this apparatus near water** - Do not use this apparatus in a water or moistures environment - for example, near a bath tub, wash bowl, kitchen sink, or laundry tub, in a wet basement, near a swimming pool, in an unprotected outdoor installation, or any area which is classified as a wet location.
6. **Warning: To reduce the risk of fire or electric shock, do not expose this apparatus to rain or moisture and no objects filled with liquids, such as vases, should be placed on this apparatus.**
7. **Clean only with dry cloth** - Unplug the apparatus from the outlet before cleaning. Do not use liquid cleaners or aerosol cleaners.
8. **Do not block any ventilation openings. Install in accordance with the manufacturer's instructions** - Openings in the enclosure, if any, are provided for ventilation and to ensure reliable operation of the apparatus and to protect it from overheating. These openings must not be blocked or covered. This apparatus should not be placed in a built-in installation unless proper ventilation is provided or the manufacturer's instructions have been adhered to.

9. **Do not install near any heat sources such as radiators, heat registers, stoves, air ducts, or other apparatus (including amplifiers) that produce heat.**
10. **Do not install the unit in a place exposed to direct sunlight, excessive dust or humidity, mechanical vibration or shock .**
11. **To avoid moisture condensations do not install the unit where the temperature may rise rapidly.**
12. **Do not defeat the safety purpose of the polarized or ground-type plug.** A polarized plug has two blades with one wider than the other. A grounding type plug has two blades and a third grounding prong. The wider blade or the third prong is provided for your safety. If the provided plug does not fit into your outlet, consult an electrician for replacement of the obsolete outlet.
13. **Protect the power cord from being walked on or pinched particularly at plug, convenience receptacles, and the point where they exit from the apparatus.**
14. **Only use attachments/accessories specified by the manufacturer .** Any mounting of the apparatus should follow the manufacturer's instructions, and should use a mounting accessory recommended by the manufacturer.
15. **Use only with the cart, stand, tripod, bracket or table specified by the manufacturer, or sold with the apparatus.**



When a cart is used, use caution when moving the cart/apparatus combination to avoid injury from tip-over - Quick stops, excessive force, and uneven surfaces may cause the appliance and cart combination to overturn.

16. **Unplug this apparatus during lightning storms or when unused for long periods of time .** – Not applicable when special functions are to be maintained, such as evacuation systems.
17. **Refer all servicing to qualified service personnel. Servicing is required when the apparatus has been damaged in any way, such as power-supply cord or plug is damaged, liquid has been spilled or objects have fallen into the apparatus, the apparatus has been exposed to rain or moisture, does not operate normally, or has been dropped.**
18. **Replacement Parts** - When replacement parts are required, be sure the service technician has used replacement parts specified by the manufacturer or having the same characteristics as the original part. Unauthorized substitutions may result in fire, electric shock or other hazards.
19. **Safety Check** - Upon completion of any service or repairs to this apparatus, ask the service technician to perform safety checks to determine that the apparatus is in proper operating condition.
20. **Overloading** - Do not overload outlets and extension cords as this can result in a risk of fire or electric shock.
21. **Power Sources** - This apparatus should be operated only from the type of power source indicated on the marking label. If you are not sure of the type of power supply you plan to use, consult your appliance dealer or local power company. For apparatuses intended to operate from battery power, or other sources, refer to the operating instructions.
22. **Power Lines** - An outdoor system should not be located in the vicinity of overhead power lines or other electric light or power circuits, or where it can fall into such power lines or circuits. When installing an outdoor system,

extreme care should be taken to keep from touching such power lines or circuits, as contact with them might be fatal.

23. **Object and Liquid Entry** - Never push objects of any kind into this apparatus through openings as they may touch dangerous voltage points or short-out parts that could result in a fire or electric shock.

Never spill liquid of any kind on the apparatus. Should any liquid or solid object fall into the cabinet, unplug the unit and have it checked by qualified personnel before operating it further.

Labels

<input type="checkbox"/>	“Lightning Flash Symbol” with the lightning flash with arrowhead symbol within an equilateral triangle, is intended to alert the user to the presence of un-insulated "dangerous voltage" within the product enclosure that may be of sufficient magnitude to constitute a risk of shock to persons.
<input type="checkbox"/>	“Exclamation Point Symbol” with the exclamation point within an equilateral triangle is intended to alert the user to the presence of important operating and maintenance (servicing) instructions in the literature accompanying the product.

Note for Power Connections

Check that the voltage of your local power supply is within the operating voltage of the unit. If a voltage conversion is required, consult your DIS dealer or qualified personnel.

Set the Power switch to 'Off' if it is not used for several days.

Important: The equipment must be connected to earth (ground)

The wires in the main lead supplied with the equipment are colored in accordance with the following codes:

- Green-and-yellow Earth (Ground)
- Blue Neutral
- Brown Live
- The green-and-yellow wire must be connected to the terminal in the plug marked with the letter E or with the safety earth symbol or marked with green-and-yellow color.
- The blue wire must be connected to the terminal marked with the letter N or marked with black color.
- The brown wire must be connected to the terminal marked with the letter L or marked with red color.
- For pluggable equipment, the socket-outlet shall be installed near the equipment and shall be easily accessible.

Power Disconnect

Apparatuses with or without On/Off switches have power supplied to the apparatus whenever the power cord is inserted into the power source; however, the apparatus is operational only when the On/Off switch is in the On position. The power cord is the main power disconnect for all apparatuses.

Compliance

The equipment is intended to be used in professional audio applications.

Note: This device is not intended to be connected directly to a public internet network.

EMC conformance to Environment E2: Commercial and Light Industrial. Testing is based on the use of supplied and recommended cable types. The use of other than shielded (screened) cable types may degrade EMC performance.

Changes or modifications not expressly approved by Shure Incorporated could void your authority to operate this equipment.

This Class B digital apparatus complies with Canadian ICES-003. Cet appareil numérique de la classe B est conforme à la norme NMB-003 du Canada.

Authorized under the verification provision of FCC Part 15B.

Please follow your regional recycling scheme for batteries, packaging, and electronic waste.

Information to the user

This equipment has been tested and found to comply with the limits for a Class B digital device, pursuant to Part 15 of the FCC Rules. These limits are designed to provide reasonable protection against harmful interference in a residential installation. This equipment generates uses and can radiate radio frequency energy and, if not installed and used in accordance with the instructions, may cause harmful interference to radio communications. However, there is no guarantee that interference will not occur in a particular installation. If this equipment does cause harmful interference to radio or television reception, which can be determined by turning the equipment off and on, the user is encouraged to try to correct the interference by one or more of the following measures:

- Reorient or relocate the receiving antenna.
- Increase the separation between the equipment and the receiver.
- Connect the equipment to an outlet on a circuit different from that to which the receiver is connected.
- Consult the dealer or an experienced radio/TV technician for help.

Cleaning

To keep the cabinet in original condition, periodically wipe it down with a soft cloth. Stubborn stains may be removed with a cloth lightly dampened with a mild detergent solution. Never use organic solvents such as thinners or abrasive cleaners since these will damage the cabinet.

Repacking

Save the original shipping box and packing material; they may be used to ship the unit. For maximum protection, re-pack the unit as originally packed from the factory.

Warranty

The units are covered by a 24 month warranty against defects in materials or workmanship.