



User Manual



H-HDCOAX-1/2/4/6/8 Modulator

A Note from Thor Broadcast about this Manual

Intended Audience

This user manual has been written to help people who have to use, integrate and to install the product. Some chapters require some prerequisite knowledge in electronics and especially in broadcast technologies and standards.

Disclaimer

No part of this document may be reproduced in any form without the written permission of Thor Broadcast. The contents of this document are subject to revision without notice due to continued progress in methodology, design and manufacturing. Thor shall have no liability for any error or damage of any kind resulting from the use of this document.

Copy Warning

This document includes some confidential information. Its usage is limited to the owners of the product that it is relevant to. It cannot be copied, modified, or translated in another language without prior written authorization from Thor Broadcast.



Table of Contents

CHAPTER 1 - INTRODUCTION	1
1.1 <i>PRODUCT OVERVIEW</i>	1
1.3 <i>SPECIFICATIONS</i>	1
1.4 <i>PRINCIPLE CHART</i>	3
1.5 <i>APPEARANCE AND DESCRIPTION</i>	3
1.5 <i>APPLICATION DRAWING</i>	4
CHAPTER 2 - INSTALLATION GUIDE	5
2.1 <i>GENERAL PRECAUTIONS</i>	5
2.2 <i>POWER PRECAUTIONS</i>	5
2.3 <i>DEVICE'S INSTALLATION FLOW CHART ILLUSTRATED (AS FOLLOWING)</i>	5
2.4 <i>ENVIRONMENT REQUIREMENT</i>	6
2.5 <i>GROUNDING REQUIREMENT</i>	7
CHAPTER 3 - OPERATION	8
3.1 <i>LCD MENU STRUCTURE</i>	8
3.2 <i>GENERAL SETTINGS</i>	10
CHAPTER 4 - WEB NMS OPERATION	15
4.1 <i>LOGIN</i>	15
4.2 <i>OPERATION</i>	16
CHAPTER 5 - TROUBLESHOOTING	23
CHAPTER 6 - PACKING LIST	24

Chapter 1 - Introduction

1.1 Product Overview

NDS3524C encoder modulator is DEXIN's a all-in-one device integrating MPEG2 encoding and modulating to convert audio/video signals into DVB-C/T/ATSC/ISDB-T RF out. It support 4 HDMI inputs, and its pay-as-you-grow modular design (maximum support 8 HDMI inputs) and flexible configuration are making it extremely scalable, very reliable with high performance. The signals source could be from STB, satellite receiver, closed-circuit television cameras and antenna etc. Its output signal is to be received by TVs or STBs etc.

The signal source could vary from satellite receivers, closed-circuit television cameras, Blu-ray players, and antenna (off air). Its output signals are to be received by TVs, STB, etc. with the correlated standard the unit is set to encode with (ATSC, DVB-T, DVB-C).

The 4-ADHD units are widely used everywhere such as the mall, market hall, theatre, hotels, restaurants, stadiums, race tracks, ampitheatres and etc. for advertising, monitoring, training and educating in company, schools, campuses, and healthcare.

1.2 Key features

- 4 HDMI independent inputs
- MPEG2 video encoding
- 1080p/i,720p, 576i , 480i video resolution
- Low Latency(50~1000ms)
- MPEGI layer 2, AAC, and Dolby Digital AC3 audio encoding
- CC (Closed Caption), EIA 608
- LCN
- DVB-C/T/ATSC/ISDB-T RF output in every device, Modulation dynamic switching
- Each channel supports 1x DVB-C/T/ATSC/ISDB-T output option
- Control via web-based NMS, and easy updates via web

1.3 Specifications

HDMI Encoding Section

Input	Interface	HDMI*4	
	Encoding	MPEG2	
Video	Input	Output	
	480@59.94/60i	480@30p	
	576@50i	576@25p	
	720@50/59.94/60p	720@25/30p	
	1080@50i	1080@25p	
	1080@59.94/60i	1080@30p	
	1080@50p	1080@25p	
	1080@59.94/60p	1080@30p	
	Bit-rate	2.000~20.000 Mbps	
	Rate Control	VBR	
Aspect Ratio	16 :9		
Audio	Encoding	MPEGI layer 2, AAC, AC3	
	Sample rate	48KHz	
	Bit rate	MPEGI layer 2 (192kbps)	
		AAC (VBR)	
		AC3 (128kbps)	

DVB-C Modulator Section

Standard	J.83A (DVB-C), J.83B	
MER	≥35dB	
RF frequency	100-1000MHz, 1KHz step	
RF output level	-63~ -16dBm (44~91 dBμV), 1dB step	
Symbol rate	3.000~7.000Msps adjustable	
	J.83A	J.83B
Constellation	16/32/64/128/256QAM	64/256QAM
Bandwidth	8M	6M

DVB-T Modulator Section

Standard	DVB-T COFDM
Bandwidth	2M, 3M, 4M, 5M, 6M, 7M, 8M
Constellation	QPSK, 16QAM, 64QAM
Code rate	1/2, 2/3, 3/4, 5/6, 7/8
Guard Interval	1/32, 1/16, 1/8, 1/4
Transmission	2K, 8K
Mode:	
MER	≥35dB
RF frequency	100-1000MHz, 1KHz step

RF output level -63~ -16dBm(44~91 dBμV), 1dB step

ISDB Modulator Section

Standard	ARIB STD-B31
Constellation	QPSK, 16QAM, 64QAM
Guard Interval	1/32, 1/16, 1/8, 1/4
Transmission Mode	2K, 4K, 8K
Code rate	1/2, 2/3, 3/4, 5/6, 7/8
RF frequency	100~1000MHz, 1KHz step
RF output level	-63~ -16dBm(44~91 dBμV), 1dB step

ATSC Modulator Section

Standard	ATSC A/53
Constellation	8 VSB
RF output level	-63~-16dBm (44~91dBμV),1dB step
MER	≥35dB
RF frequency	100~1000MHz, 1KHz step
RF output level	-63~ -16dBm(44~91 dBμV), 1dB step

System

Management	Web
Language	English
Upgrade	Web update

General

Power supply	AC 100V±10%, 50/60Hz or AC 220V±10%, 50/60Hz
Dimensions	482*328*44.5mm
Temperature	0~45°C(operation), -20~80°C (storage)

1.4 Principle Chart

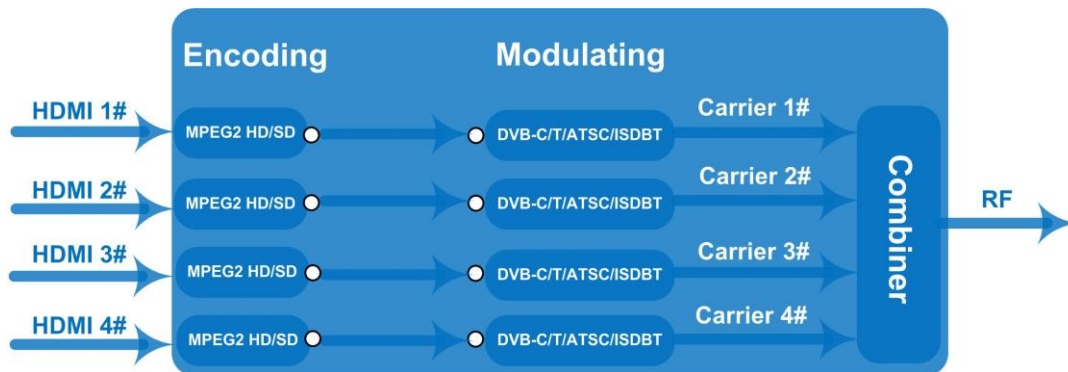

1.5 Appearance and Description

Front Panel Illustration

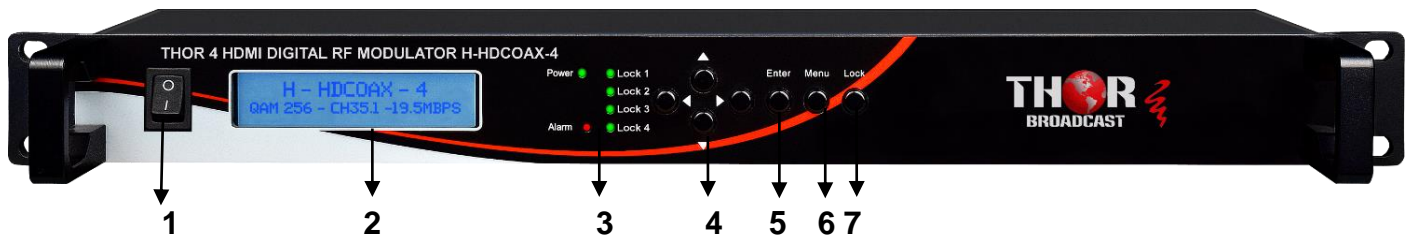

- ① Power Switch
- ② LCD Screen
- ③ Power and Alarm Indicators
- ④ Directional Keys (up, down, left, right)
- ⑤ Enter Key
- ⑥ Menu Key
- ⑦ Lock Key

Rear Panel Illustration

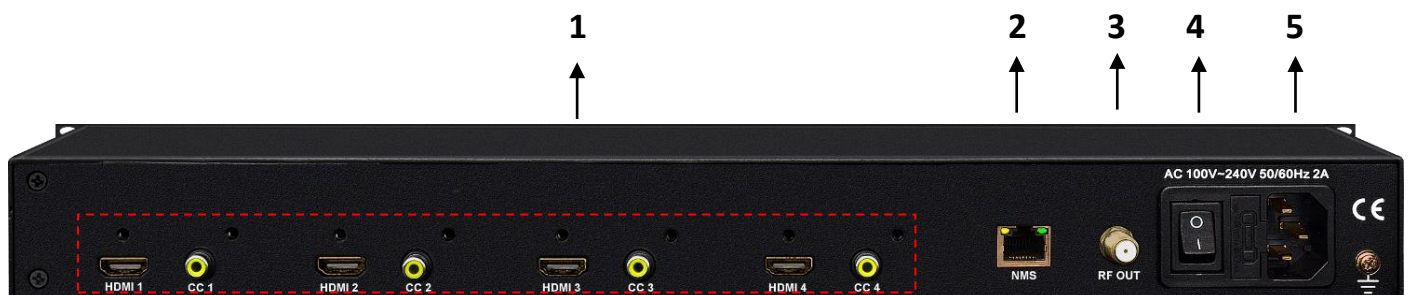

- ① HDMI + CC Input Port
- ② NMS Ethernet Port
- ③ RF Output
- ④ L/R Audio input (Stereo or Mono)
- ⑤ SPDIF port (Not applicable at present)
- ⑥ ASI input port
- ⑦ ASI Output port 1&2
- ⑧ Power Switch
- ⑨ Power supply Slot
- ⑩ RF out port

1.5 Application Drawing

New Affordable 8 HDMI Digital RF Modulator with CC (Closed Captioning) (QAM / ATSC / DVB-T / ISDB-T) up to 1080p60 / Low Latency

- AC3, MPEG1 Audio Encoding
- MPEG2 Video Encoding
- Low Latency
- Up to 1080p60
- NMS IP WEB management
- LCD Display and front panel control
- CC – Closed Captioning CVBS input

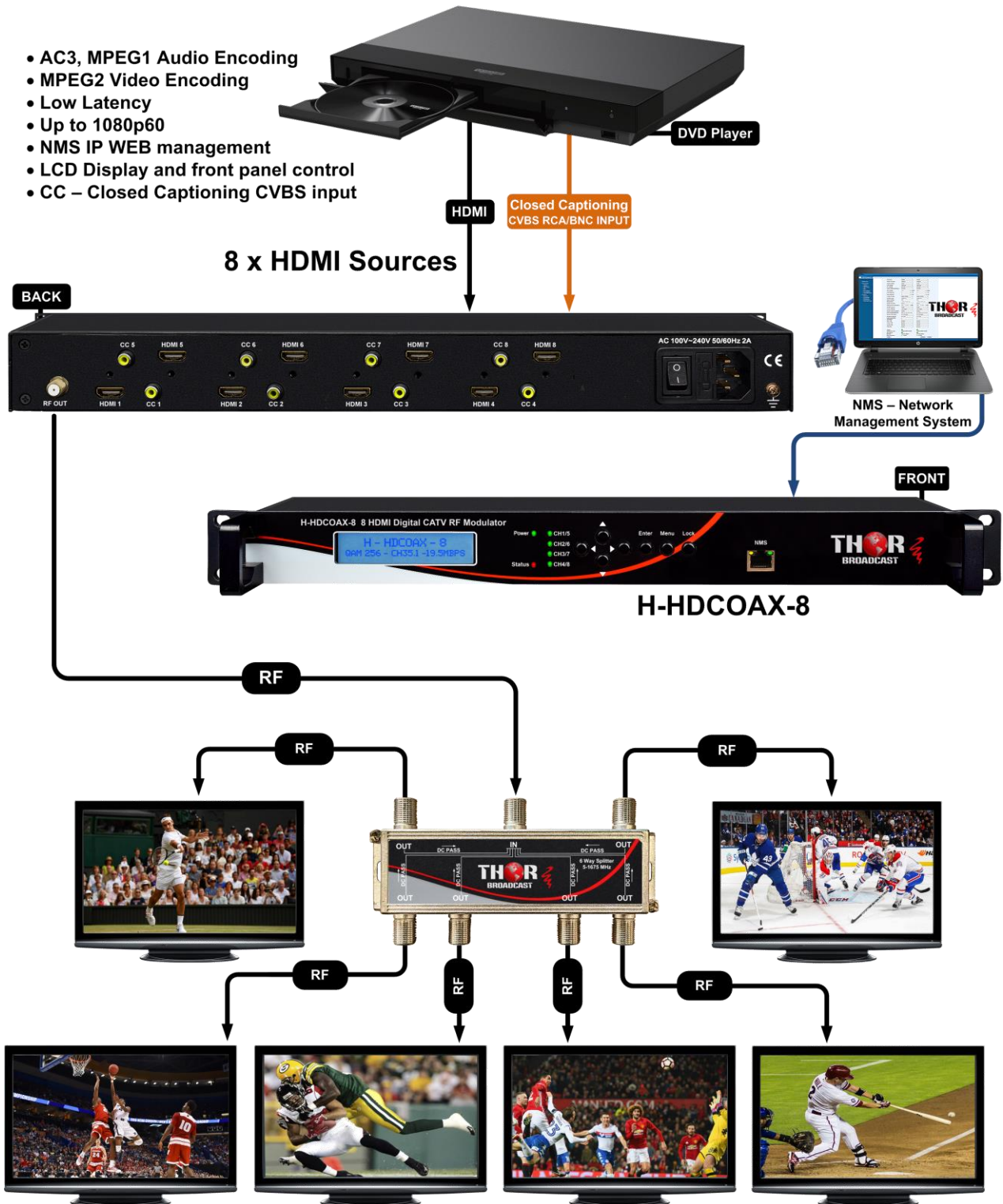

Chapter 2 - Installation Guide

2.1 General Precautions

- ✓ Must be operated and maintained in an area free of dust and debris.
- ✓ The cover should be securely fastened, do not open the cover of the chassis when the power is on.
This will also void Thor's manufacturer's warranty.
- ✓ After installation, securely stow away all loose cables, external antenna, and others.

2.2 Power precautions

- ✓ Be careful when connecting a power source to the device.
- ✓ Do not operate in wet or damp areas. Make sure the extension cable is in good condition
- ✓ Make sure the power switch is off before you start to install the device

2.3 Device's Installation Flow Chart Illustrated (as following)

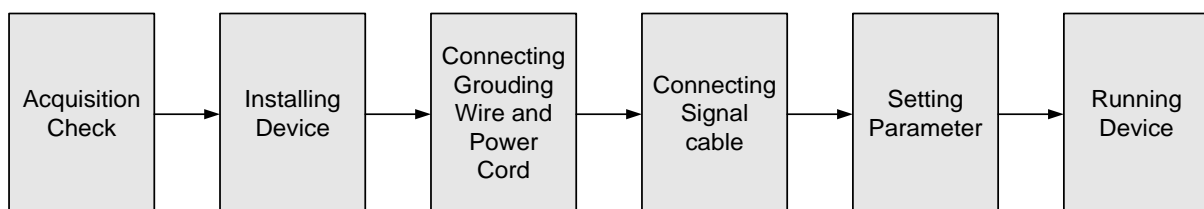

2.4 Environment Requirement

Item	Requirement
Machine Hall Space	When installing unit on rack, the distance between 2 rows of machine frames should be 1.2~1.5m and the distance against wall should be no less than 0.8m.
Machine Hall Floor	Electric Isolation, Dust Free, HVAC anti-static material: $1 \times 10^7 \sim 1 \times 10^{10} \Omega$, Grounding current limiting resistance: $1 M\Omega$ (Floor bearing should be greater than 450Kg/m^2)
Environment Temperature	5~40°C(sustainable) , 0~45°C(short time) , installing air-conditioning is recommended
Relative Humidity	20%~80% sustainable 10%~90% short time
Pressure	86~105KPa
Door & Window	Installing rubber strip for sealing door-gaps and dual level glasses for window
Fire Protection	Fire alarm system and extinguisher
Power	Device power, HVAC and lighting should be independent to each other. Device power requires AC $110\text{V} \pm 10\%$, 50/60Hz or AC $220\text{V} \pm 10\%$, 50/60Hz. Please carefully check before running.

2.5 Grounding Requirement

- ✓ It is important to keep this device grounded to ensure all of the modules function correctly. Correctly grounding the device will also help prevent any electrical interference, lightening. Etc. Also it helps reject minor interference that may disrupt the devices ability to function smoothly. General rule of them, make sure the device is grounded when installing anywhere.

- ✓ Always use copper wire. When applied correctly the ground must be wrapped well to ensure maximum conduction so it can reduce any high frequencies. The copper ground wire should also be as short and thick as possible

- ✓ Installer must make sure that the two ends of the ground are well conducted and have appropriate anti-rust properties.

- ✓ It is prohibited to use any other device as part of the grounding electric circuit.

- ✓ The area of the conduction between the ground wire and device's frame should be no less than 25 m².

Chapter 3 - Operation

Keyboard Function Description:

MENU: Cancel current entered value, resume previous setting; Return to previous menu.

ENTER: Activate the parameters which need modifications, or confirm the change after modification.

LEFT/RIGHT: Choose and set the parameters.

UP/DOWN: Modify activated parameter or paging up/down when parameter is inactivated.

LOCK: Lock the screen/cancel the lock state. After pressing the lock key, the LCD will display the current configuring state.

3.1 LCD Menu Structure

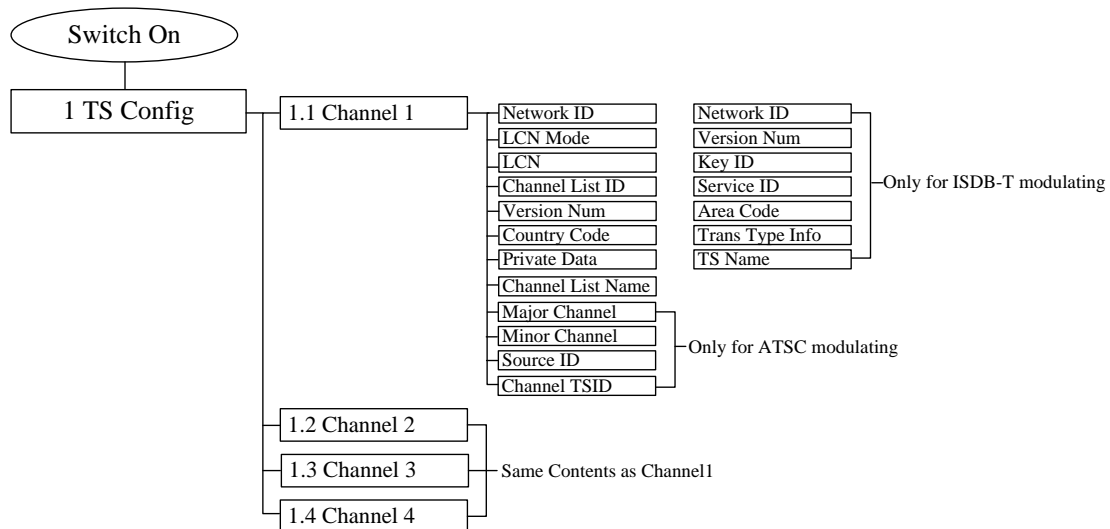

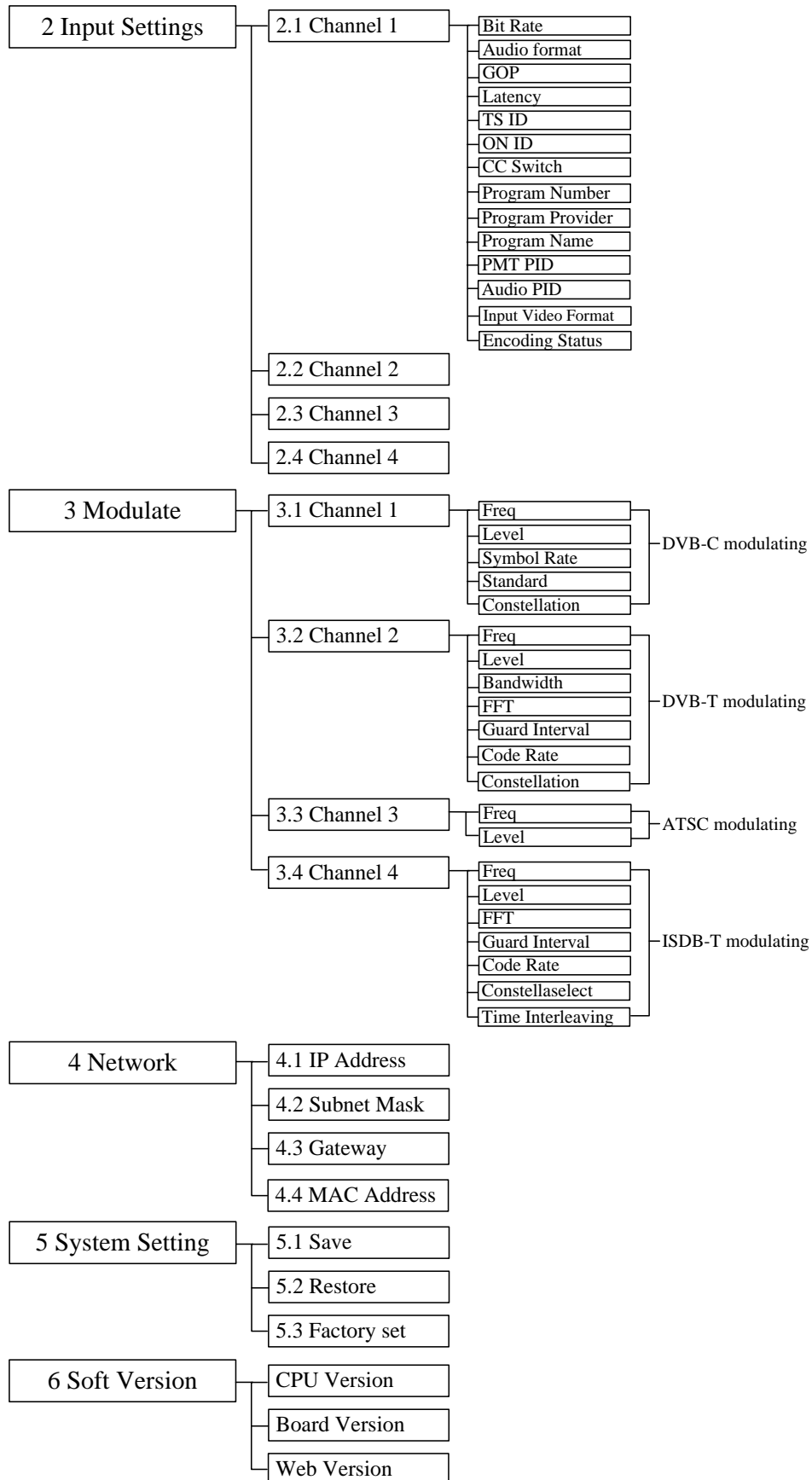

3.2 General Settings

After powering on the device, press Lock to bring up the menu tree of optional 6 menu's and submenus in order to control your device through the LCD and D-Pad buttons.

- ▶ 1 TS Config
- 2 Encode
- 3 Modulate
- 4 Network
- 5 System Settings
- 6 Soft Version

The option with “▶” is the current selection, press the ENTER key to enter the specified submenu to modify the parameters.

3.2.1 TS Config

The Thor HDCOAX-4 outputs up to 4 RF modulation carriers. Under this menu you can enter the corresponding channels to set your relevant parameters. Select each channel and set your settings as you see fit. After pressing the enter key, the LCD will display the following pages:

- ▶ 2.1 Channel 1
- 2.2 Channel 2
- 2.3 Channel 3
- 2.4 Channel 4

➤ **Channel 1/2/3/4**

The HDCOAX-4 also has can output any standard DVB-C, DVB-T, ATSC or ISDB-T modulation. Select different modulation modes under the modulate menu, the TS parameters will be different with each standard, the LCD will display the following submenu's:

DVB-C/ DVB-T:

▶ Network ID
LCN Mode
LCN
Channel List ID
Version Num
Country Code
Private Data
Channel List Name

ATSC:

▶ Network ID
LCN Mode
LCN
Channel List ID
Version Num
Country Code
Private Data
Channel List Name
Major Channel
Minor Channel
Source ID
Channel TSID

ISDB-T:

▶ Network ID
Version Num
Key ID
Service ID
Area Code
Trans Type Info
TS Name

3.2.2 Encode

This Thor Broadcast HDCOAX-4 is will allow you to alter audio and video settings as needed per channel 1/2/3/4 for variable results.

- ▶ 2.1 Channel 1
- 2.2 Channel 2
- 2.3 Channel 3
- 2.4 Channel 4

➤ **Channel 1/2/3/4**

The setting submenus are the same for Channels 1-4, so here we'll show you one channel as an example. Press the enter key and the submenu will show as follows on the LCD:

- ▶ 2.1 Channel 1
- Bit Rate
- Audio format
- GOP
- Latency
- TS ID
- ON ID
- CC Switch
- Program Number
- Program Provider
- Program Name
- PMT PID
- Video PID
- Audio PID
- Input Video Format
- Encoding Status

3.2.3 Modulate

The HDCOAX-4 has up to 4 RF carriers, enter the corresponding channel to set the relevant RF output parameters.

- ▶ 2.1 Channel 1
- 2.2 Channel 2
- 2.3 Channel 3
- 2.4 Channel 4

➤ **Channel 1/2/3/4**

Set these parameters by pressing ENTER to enter these submenus.

DVB-C:

▶ Freq
Level
Symbol Rate
Standard
Constellation

DVB-T:

▶ Freq
Level
Bandwidth
FFT
Guard Interval
Code Rate
Constellation

ATSC:

▶ Freq
Level

ISDB-T:

▶ Freq
Level
FFT
Guard Interval
Code Rate
Constellaselect
Time Interleaving

3.2.4 Network Setting

The Network Setting has four submenus as shown below.

IP Address
192.168.000.136

Subnet Mask
255.255.255.000

Gateway
192.168.000.001

MAC Address
XX:XX:XX:XX:XX:XX

3.2.5 System Setting

➤ Save

Always save your settings each time you change them, so the next time you restart the unit, they appear as you wanted them.

Saving Config
▶ YES NO

➤ Restore

In this menu, choose yes to restore the device the last saved configuration.

Restore
▶ YES NO

➤ Factory Set

Choose yes to restore the device into factory's default configuration.

Factory Set
▶ YES NO

3.2.6 Soft Version

Check the CPU, Board and Web version of this modulator under this submenu.

CPU/Board/Web Version
XX:XX:XX

Chapter 4 - WEB NMS Operation

For setting configurations you can use the front panel; also you are able to control and set the configurations on any computer by connecting the device to the web NMS Port. You should ensure that the computer's IP address is different from the THOR HDCOAX-4 IP address; otherwise, it would cause an IP conflict.

4.1 Login

The default IP of this device is 192.168.0.136. We can modify the IP through the front panel.

Connect the pc and the device with net cable, and use ping command to confirm they are on the same network segment.

E.G. the PC IP address is 192.168.99.252, we then change the device IP to 192.168.99.xxx (xxx can be 0 to 255 except 252 to avoid IP conflict).

Use any web browser to connect the device with the PC by inputting the Encoder & Modulator's IP address in the browser's address bar and press Enter.

It will display the Login interface as Figure-1. Input the Username and Password (Both the default Username and Password are "admin".) and then click "LOGIN" to start the device setting.

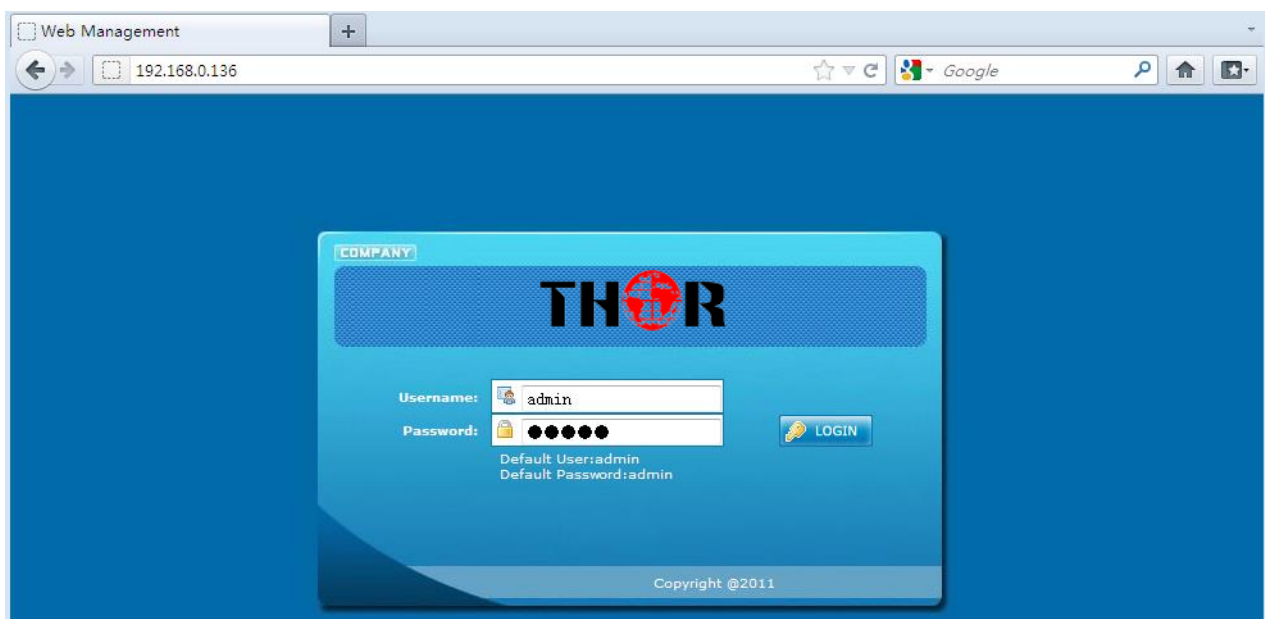

Figure-1

4.2 Operation

Welcome

When we confirm the login, it displays the WELCOME interface as shown in Figure-2.

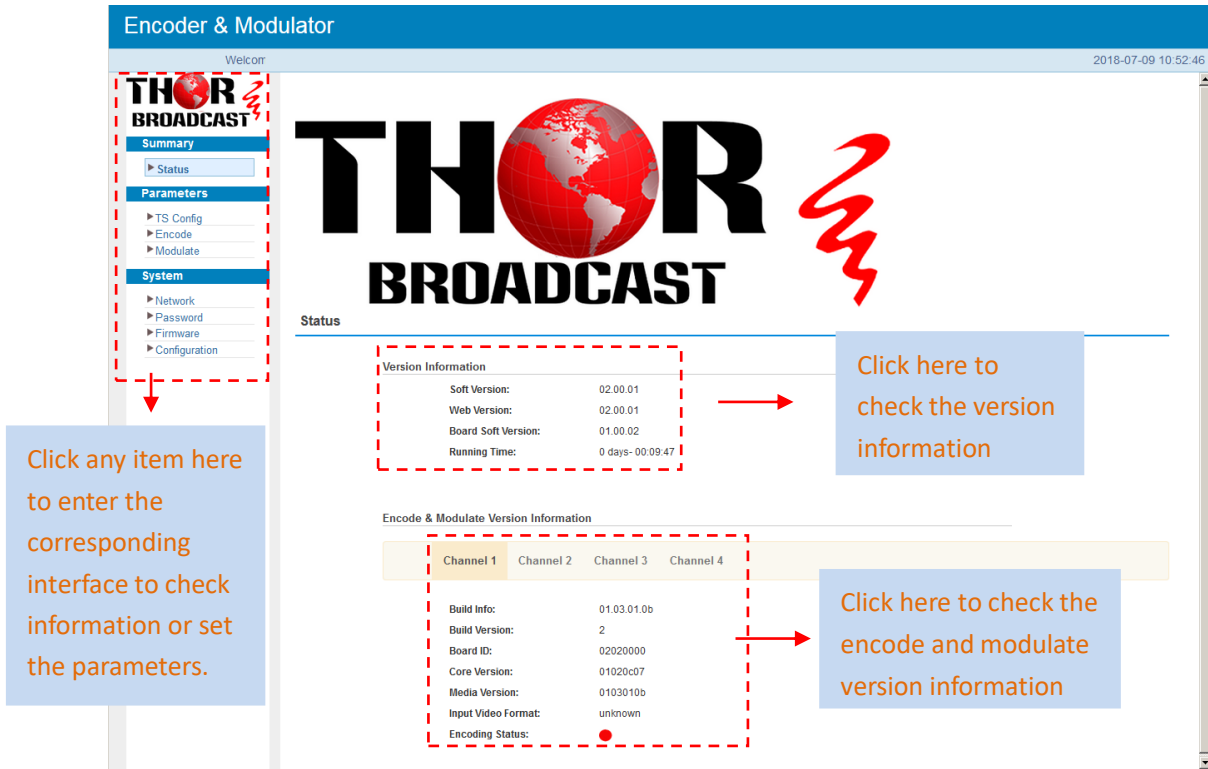
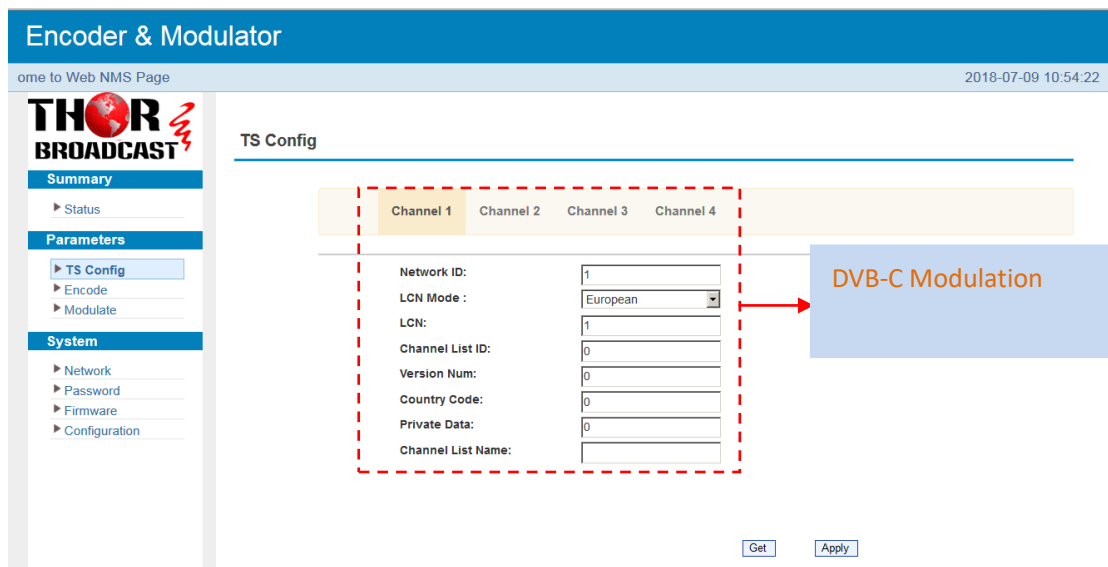

Figure-2

Parameters → TS Config:

Clicking “TS Config”, users can configure 4 channels of the output TS, users select different modulating modes, the TS config parameters will be different (Figure-3).



Encoder & Modulator

MS Page 2018-07-09 10:54:48

Summary

- Status

Parameters

- TS Config**
- Encode
- Modulate

System

- Network
- Password
- Firmware
- Configuration

TS Config

Channel 1	Channel 2	Channel 3	Channel 4																
<div style="border: 2px dashed red; padding: 5px;"> <table style="width: 100%; border-collapse: collapse;"> <tr><td>Network ID:</td><td><input type="text" value="2"/></td></tr> <tr><td>LCN Mode :</td><td><input type="text" value="European"/></td></tr> <tr><td>LCN:</td><td><input type="text" value="2"/></td></tr> <tr><td>Channel List ID:</td><td><input type="text" value="0"/></td></tr> <tr><td>Version Num:</td><td><input type="text" value="0"/></td></tr> <tr><td>Country Code:</td><td><input type="text" value="0"/></td></tr> <tr><td>Private Data:</td><td><input type="text" value="0"/></td></tr> <tr><td>Channel List Name:</td><td><input type="text"/></td></tr> </table> </div>				Network ID:	<input type="text" value="2"/>	LCN Mode :	<input type="text" value="European"/>	LCN:	<input type="text" value="2"/>	Channel List ID:	<input type="text" value="0"/>	Version Num:	<input type="text" value="0"/>	Country Code:	<input type="text" value="0"/>	Private Data:	<input type="text" value="0"/>	Channel List Name:	<input type="text"/>
Network ID:	<input type="text" value="2"/>																		
LCN Mode :	<input type="text" value="European"/>																		
LCN:	<input type="text" value="2"/>																		
Channel List ID:	<input type="text" value="0"/>																		
Version Num:	<input type="text" value="0"/>																		
Country Code:	<input type="text" value="0"/>																		
Private Data:	<input type="text" value="0"/>																		
Channel List Name:	<input type="text"/>																		

Get Apply

DVB-T Modulation

Encoder & Modulator

Page 2018-07-09 10:55:06

Summary

- Status

Parameters

- TS Config**
- Encode
- Modulate

System

- Network
- Password
- Firmware
- Configuration

TS Config

Channel 1	Channel 2	Channel 3	Channel 4																								
<div style="border: 2px dashed red; padding: 5px;"> <table style="width: 100%; border-collapse: collapse;"> <tr><td>Network ID:</td><td><input type="text" value="3"/></td></tr> <tr><td>LCN Mode :</td><td><input type="text" value="European"/></td></tr> <tr><td>LCN:</td><td><input type="text" value="3"/></td></tr> <tr><td>Channel List ID:</td><td><input type="text" value="0"/></td></tr> <tr><td>Version Num:</td><td><input type="text" value="0"/></td></tr> <tr><td>Country Code:</td><td><input type="text" value="0"/></td></tr> <tr><td>Private Data:</td><td><input type="text" value="0"/></td></tr> <tr><td>Channel List Name:</td><td><input type="text"/></td></tr> <tr><td>Major Channel:</td><td><input type="text" value="32"/></td></tr> <tr><td>Minor Channel:</td><td><input type="text" value="2"/></td></tr> <tr><td>Source ID:</td><td><input type="text" value="3"/></td></tr> <tr><td>Channel TSID:</td><td><input type="text" value="103"/></td></tr> </table> </div>				Network ID:	<input type="text" value="3"/>	LCN Mode :	<input type="text" value="European"/>	LCN:	<input type="text" value="3"/>	Channel List ID:	<input type="text" value="0"/>	Version Num:	<input type="text" value="0"/>	Country Code:	<input type="text" value="0"/>	Private Data:	<input type="text" value="0"/>	Channel List Name:	<input type="text"/>	Major Channel:	<input type="text" value="32"/>	Minor Channel:	<input type="text" value="2"/>	Source ID:	<input type="text" value="3"/>	Channel TSID:	<input type="text" value="103"/>
Network ID:	<input type="text" value="3"/>																										
LCN Mode :	<input type="text" value="European"/>																										
LCN:	<input type="text" value="3"/>																										
Channel List ID:	<input type="text" value="0"/>																										
Version Num:	<input type="text" value="0"/>																										
Country Code:	<input type="text" value="0"/>																										
Private Data:	<input type="text" value="0"/>																										
Channel List Name:	<input type="text"/>																										
Major Channel:	<input type="text" value="32"/>																										
Minor Channel:	<input type="text" value="2"/>																										
Source ID:	<input type="text" value="3"/>																										
Channel TSID:	<input type="text" value="103"/>																										

Get Apply

ATSC Modulation

Encoder & Modulator

NMS Page 2018-07-09 10:55:23

Summary

- Status

Parameters

- TS Config**
- Encode
- Modulate

System

- Network
- Password
- Firmware
- Configuration

TS Config

Channel 1	Channel 2	Channel 3	Channel 4														
<div style="border: 2px dashed red; padding: 5px;"> <table style="width: 100%; border-collapse: collapse;"> <tr><td>Network ID:</td><td><input type="text" value="4"/></td></tr> <tr><td>Version Num:</td><td><input type="text" value="0"/></td></tr> <tr><td>Key ID:</td><td><input type="text" value="0"/></td></tr> <tr><td>Service ID:</td><td><input type="text" value="5"/></td></tr> <tr><td>Area Code:</td><td><input type="text" value="0"/></td></tr> <tr><td>Trans Type Info:</td><td><input type="text" value="0"/></td></tr> <tr><td>Ts Name:</td><td><input type="text"/></td></tr> </table> </div>				Network ID:	<input type="text" value="4"/>	Version Num:	<input type="text" value="0"/>	Key ID:	<input type="text" value="0"/>	Service ID:	<input type="text" value="5"/>	Area Code:	<input type="text" value="0"/>	Trans Type Info:	<input type="text" value="0"/>	Ts Name:	<input type="text"/>
Network ID:	<input type="text" value="4"/>																
Version Num:	<input type="text" value="0"/>																
Key ID:	<input type="text" value="0"/>																
Service ID:	<input type="text" value="5"/>																
Area Code:	<input type="text" value="0"/>																
Trans Type Info:	<input type="text" value="0"/>																
Ts Name:	<input type="text"/>																

Get Apply

ISDB-T Modulation

Figure-3

Parameters → Encode:

Click “Encode”, it displays the information of the program from the 4 HDMI encoded channels

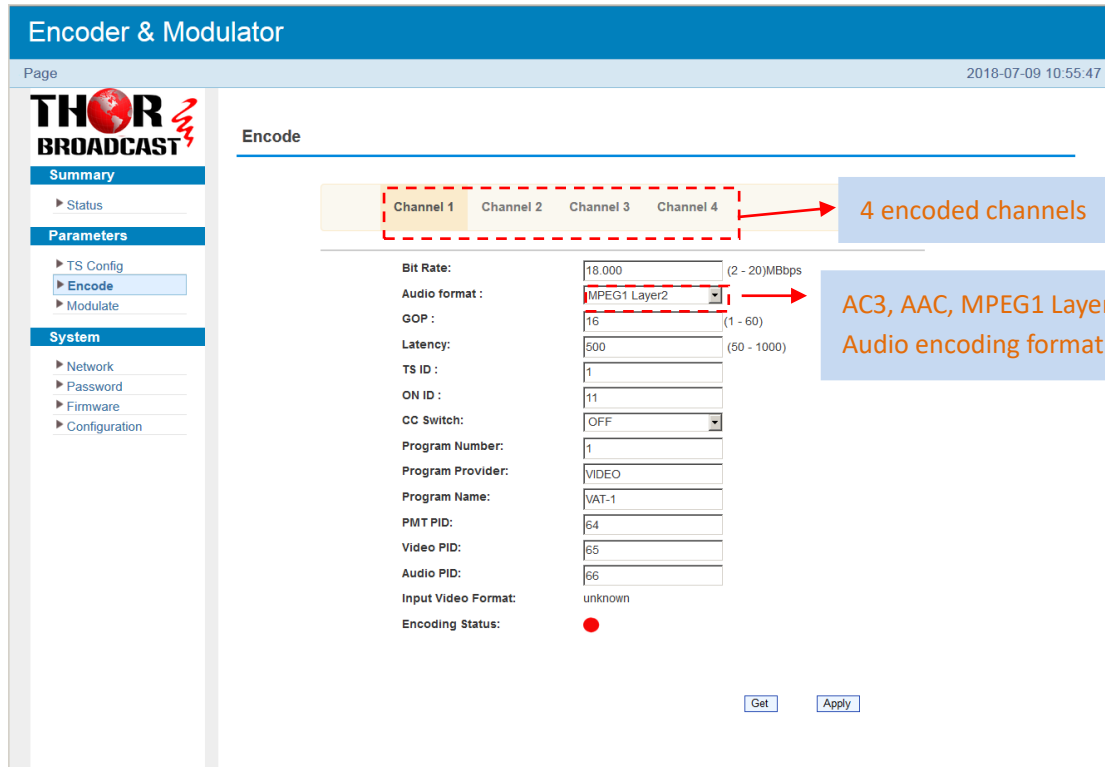

Figure-4

Parameters → Modulate:

Click “Modulate”, it displays the interface where users can configure the modulating parameters.

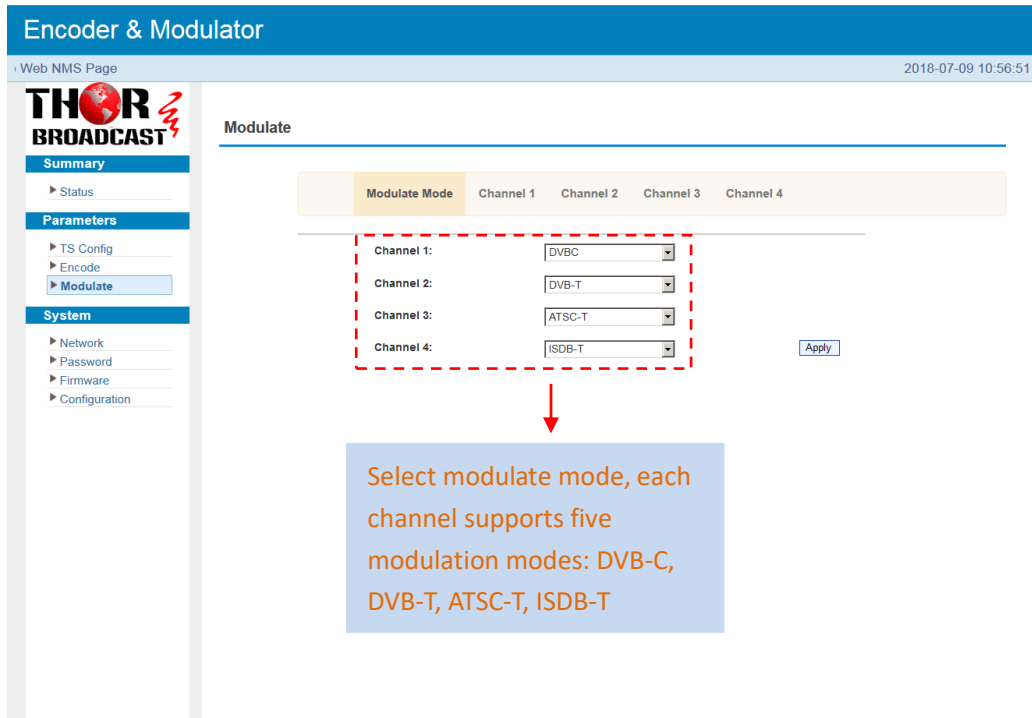
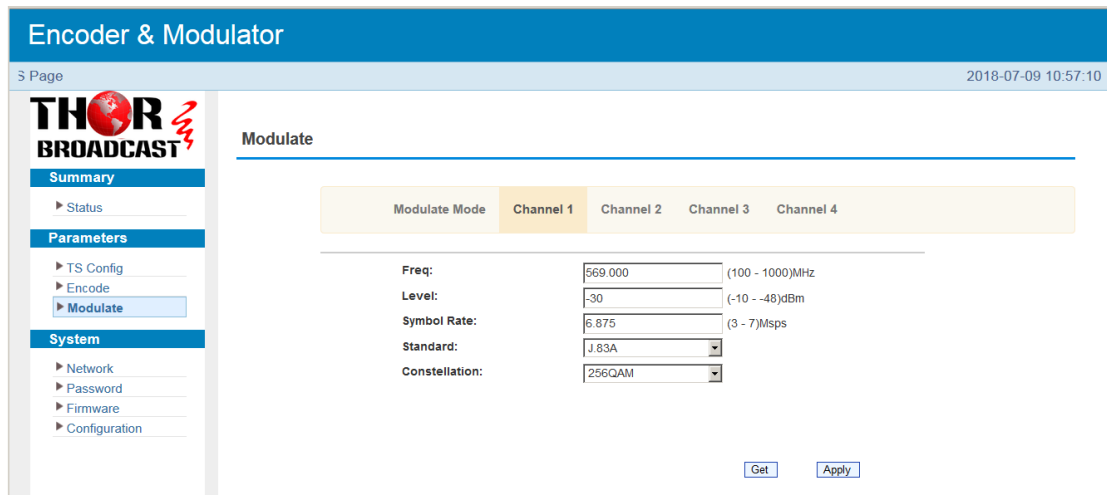

Figure-5

Click “Channel1/2/3/4”, it displays the interface where you can configure the modulating parameters.

Channel 1: DVB-C modulation



Channel 2: DVB-T modulation

Encoder & Modulator

IS Page 2018-07-09 10:57:33

Summary

- Status

Parameters

- TS Config
- Encode
- Modulate**

System

- Network
- Password
- Firmware
- Configuration

Modulate

Modulate Mode	Channel 1	Channel 2	Channel 3	Channel 4
Freq:		<input type="text" value="575.000"/>		(100 - 1000)MHz
Level:		<input type="text" value="-30"/>		(-10 - -48)dBm
Bandwidth:		<input type="text" value="8M"/>		
FFT:		<input type="text" value="2K"/>		
Guard Interval:		<input type="text" value="1/16"/>		
Code Rate:		<input type="text" value="3/4"/>		
Constellation:		<input type="text" value="64QAM"/>		

Channel 3: ATSC modulation

Encoder & Modulator

Welk 2018-07-09 10:57:52

Summary

- Status

Parameters

- TS Config
- Encode
- Modulate**

System

- Network
- Password
- Firmware
- Configuration

Modulate

Modulate Mode	Channel 1	Channel 2	Channel 3	Channel 4
Freq:			<input type="text" value="581MHz CH:32"/>	(100 - 1000)MHz
Level:			<input type="text" value="-30"/>	(-10 - -48)dBm

Channel 4: ISDB-T modulation

Encoder & Modulator

Welcor 2018-07-09 10:58:10

Summary

- Status

Parameters

- TS Config
- Encode
- Modulate**

System

- Network
- Password
- Firmware
- Configuration

Modulate

Modulate Mode	Channel 1	Channel 2	Channel 3	Channel 4
Freq:				<input type="text" value="587.000"/>
Level:				<input type="text" value="-30"/>
FFT:				<input type="text" value="2K"/>
Guard Interval:				<input type="text" value="1/16"/>
Code Rate:				<input type="text" value="3/4"/>
Constellaselect:				<input type="text" value="DQPSK"/>
Time Interleaving:				<input type="text" value="0"/>

Figure-6

System → Network:

Click “Network”, it displays the where to set network parameters.

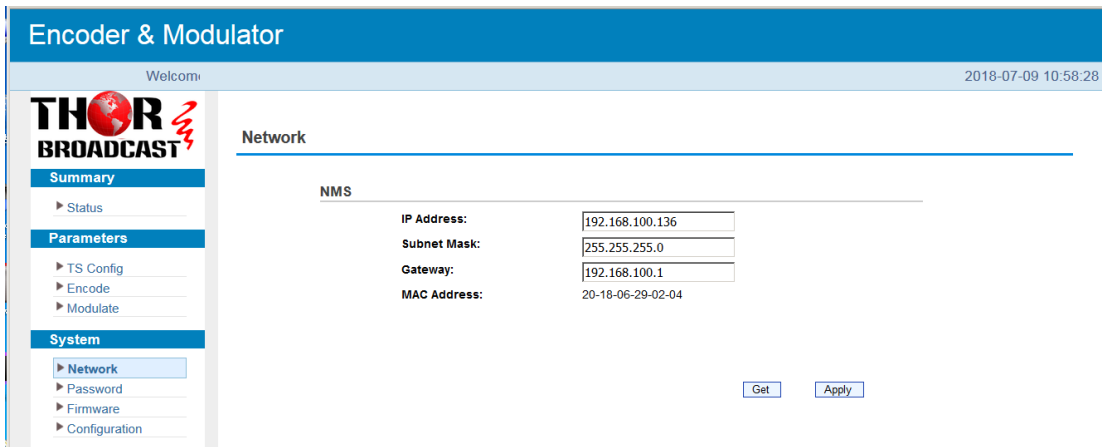

Figure-7

System → Password:

Click “Password”, it displays the screen where to set login account and password for the web NMS.

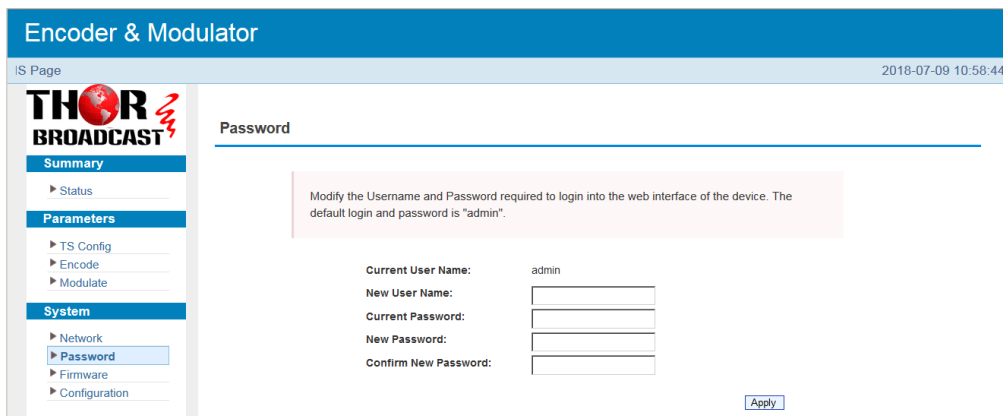

Figure-8

System → Firmware:

Click “Firmware”, it displays the screen where to update the firmware on this HDCOAX-4.

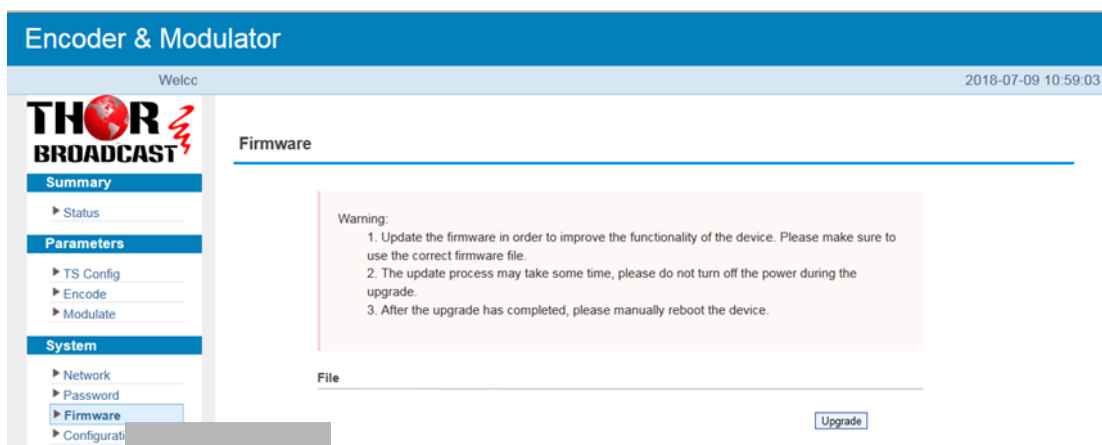

Figure-9

System → Save/Restore/Factory Set/Backup/Load:

Click “Save/Restore/Factory Set/Backup/Load”, it displays the screen where to Save/Restore/Factory Set/Backup/Load your configurations.

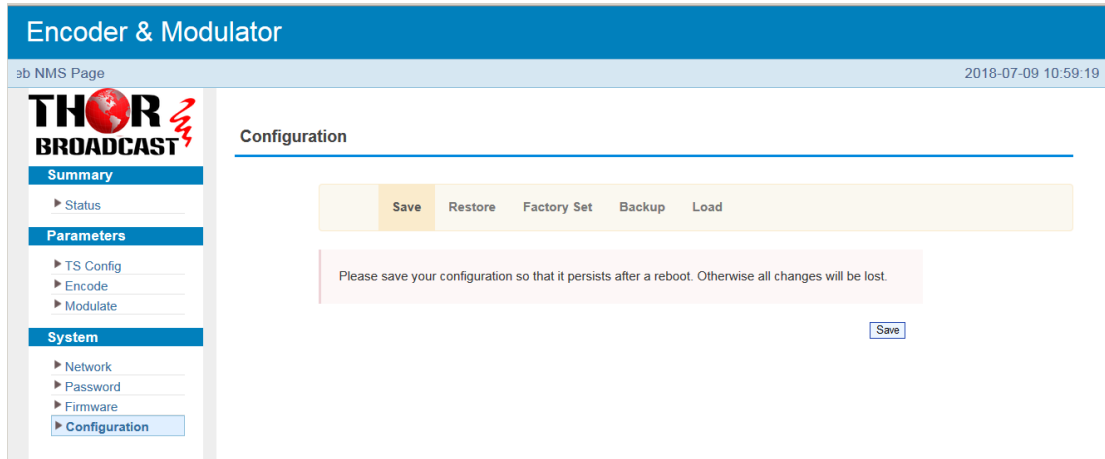

Figure-10

Chapter 5 - Troubleshooting

THOR's ISO9001 quality assurance system has been approved by the CQC organization. We guarantee the products' quality, reliability and stability. All THOR products have passed all testing and manual inspections before they are shipped out. The testing and inspection scheme already covers all the Optical, Electronic and Mechanical criteria which have been published by THOR. To prevent a potential hazard, please strictly follow the operation conditions.

Prevention Measures

- Installing the device in a place where the environmental temperature is between 0 to 45 °C
- Making sure the unit has plenty of ventilation for the heat-sink on the rear panel; and other heat-sink bores if necessary
- Checking the AC input within the power supply and ensure it is working, the connection is correctly installed before switching on device
- Checking the RF output levels to stay within a tolerable range, if it is necessary
- Checking all signal cables have been properly connected
- Frequently switching on/off device is prohibited; the interval between every switching on/off must be greater than 10 seconds.

Conditions needed to unplug power cord

- Power cord or socket damage.
- Any liquid that got into the device.
- Any stuff that could cause a circuit short
- Device in damp environment
- Device has suffered from physical damage; i.e. it fell off a rack.
- Longtime idle.
- After switching on and restoring to factory setting, device still won't work properly.
- Maintenance needed on device



H-HDCOAX-1/2/4/6/8

Chapter 6 - Packing List

THOR BROADCAST HDCOAX-4	1 PC
User's Manual	1 PC
HDMI Cables	1/2/4/6/8 PCS
Power Cord	1 PC

For Further Tech Support

1-800-521-Thor(8467)

support@thorfiber.com



H-HDCOAX-1/2/4/6/8

CATV QAM Channel Center Frequency - 54 MHz to 860 MHz

EIA CH.	MHz Center Frequency	EIA CH.	MHz Center Frequency	EIA CH.	MHz Center Frequency
2	57	42	333	87	603
3	63	43	339	88	609
4	69	44	345	89	615
5	79	45	351	90	621
6	85	46	357	91	627
95	93	47	363	92	633
96	99	48	369	93	639
97	105	49	375	94	645
98	111	50	381	100	651
99	117	51	387	101	657
14	123	52	393	102	663
15	129	53	399	103	669
16	135	54	405	104	675
17	141	55	411	105	681
18	147	56	417	106	687
19	153	57	423	107	693
20	159	58	429	108	699
21	165	59	435	109	705
22	171	60	441	110	711
7	177	61	447	111	717
8	183	62	453	112	723
9	189	63	459	113	729
10	195	64	465	114	735
11	201	65	471	115	741
12	207	66	477	116	747
13	213	67	483	117	753
23	219	68	489	118	759
24	225	69	495	119	765
25	231	70	501	120	771
26	237	71	507	121	777
27	243	72	513	122	783
28	249	73	519	123	789
29	255	74	525	124	795
30	261	75	531	125	801
31	267	76	537	126	807
32	273	77	543	127	813
33	279	78	549	128	819
34	285	79	555	129	825
35	291	80	561	130	831
36	297	81	567	131	837
37	303	82	573	132	843
38	309	83	579	133	849
39	315	84	585	134	855
40	321	85	591	135	861
41	327	86	597		

