

Installation Guide

SRXUPANEL

Airflow Management Blanking Panel Kit

Contents

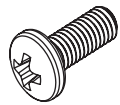

M6 Screw
x16

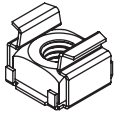

M6 Cage Nut
x16



M6 Cup Washer
x16

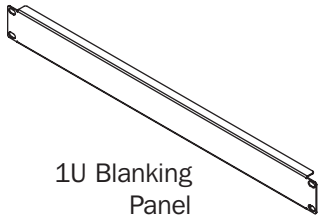

1U Blanking
Panel

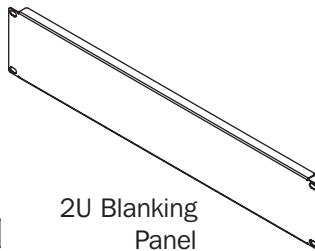

2U Blanking
Panel

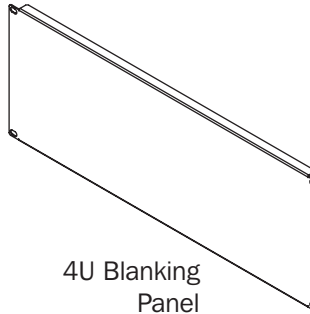

4U Blanking
Panel

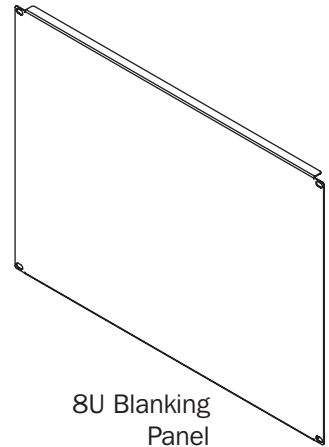

8U Blanking
Panel

Installation

Attach and secure the desired blanking panel to the front vertical rails of the rack enclosure with four M6 Screws, Cup Washers and Cage Nuts. Repeat for each additional blanking panel.

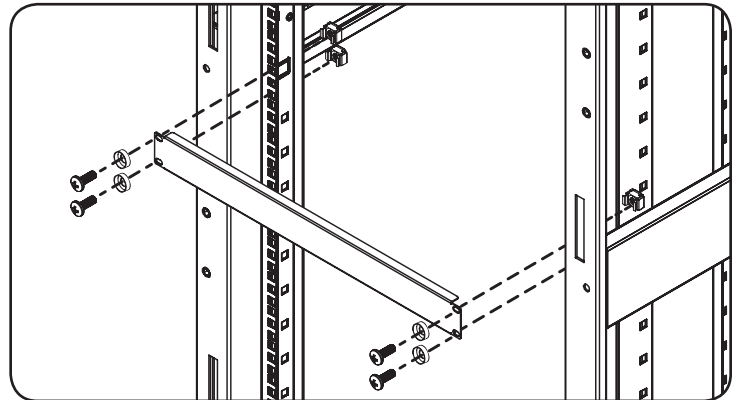

1U blanking panel shown. All panels install the same, regardless of size.

Tripp Lite has a policy of continuous improvement. Specifications are subject to change without notice.

PROTECT YOUR INVESTMENT!

Register your product for quicker service and ultimate peace of mind.

You could also win an ISOBAR6ULTRA surge protector—a \$100 value!

www.tripplite.com/warranty



1111 W. 35th Street, Chicago, IL 60609 USA • www.tripplite.com/support

Copyright © 2015 Tripp Lite. All rights reserved.