



Installation Guide for the

DocCAM 20 HDBT

Ceiling-Mounted Document Camera

Document 411-0017-31 Rev E
May 2018

Contents

Overview	1
What's in this Guide	1
Features	1
Unpacking the Camera	2
A Quick Look at the Camera	3
Features of Interest During Installation	4
Connector Panel	4
Features of Interest During Operation	5
Installing the Camera	6
Don't Void Your Warranty!	6
Cabling Notes	6
Pre-Installation Functional Check	7
Basic Connection Diagram	7
Options for Power and Other Connections	8
About Installation Height and Viewing Area	9
Selecting the Installation Area	9
Things You Will Need for the Installation	10
Installing the Camera in a Suspended Tile Ceiling	10
Preparing the Tile Ceiling	10
Completing the Installation in a Tile Ceiling	11
Installing the Camera in a Hard Ceiling	11
Preparing the Hard Ceiling	11
Completing the Installation in a Hard Ceiling	12
Powering Up the Camera	13
Status Light	14
Next Steps	14
Compliance Statements and Declarations of Conformity	15
FCC Part 15 Compliance	15
ICES-003 Compliance	16
European Compliance	16
Warranty Information	17
Index	18

Overview

This guide describes installation and related information for the DocCAM 20 HDBT ceiling-mounted document camera:

- Camera only, worldwide – 999-9968-000
- Camera with OneLINK HDMI camera extension, North America – 999-9968-200
- Camera with OneLINK HDMI camera extension, Europe/UK – 999-9968-201
- Camera with OneLINK Bridge A/V interface, North America – 999-9968-300
- Camera with OneLINK Bridge A/V interface, Europe/UK – 999-9968-301



What's in this Guide

This guide covers:

- Unpacking the camera
- Tips for a successful installation
- Information on mounting and connecting the camera
- Camera power-on

Complete product information is available in the **Integrator's Complete Guide to the DocCAM 20 HDBT Ceiling-Mounted Document Camera**.

Download manuals, dimensional drawings, and other information from www.vaddio.com/support.

Features

- Exmor® 1/2.8 type, high-speed, low-noise image sensor for 2.38 megapixels total, full HD (native 1080p/60)
- 20x optical zoom with horizontal field of view from 60° (wide end) to 3.3° (tele end)
- Low-power laser pointer for centering
- Superior low-light performance (0.4 Lux)
- Web interface for remote administration and operation, integration-ready Telnet and serial RS-232 control, presenter-friendly IR remote control
- Use with a OneLINK device for power, video, and control:
 - OneLINK HDMI – uncompressed HDMI video, bidirectional RS-232 connectivity for camera control via third-party equipment, passes IP stream from the camera
 - OneLINK Bridge – OneLINK HDMI capabilities plus uncompressed USB 3.0 streaming, HD-SDI output, and audio routed up to the camera and injected into the IP stream

Camera assembly numbers 998-9968-001 and 998-9968-100:

Class 1 Laser Product (IEC 60825-1:2014)

Produit Laser de la Classe 1 (IEC 60825-1:2014)

Klass 1 Laserprodukt (IEC 60825-1:2014)

Camera assembly number 998-9968-000 only:

This product contains a Class 3 laser.

Unpacking the Camera

Note

This camera is shipped with a mounting kit for use in suspended acoustic tile ceilings. If you plan to mount the camera in a hard ceiling (such as gypsum board), you will need mounting kit 998-2225-152.

Make sure you receive all the items you expected.

DocCAM 20 HDBT, camera only

999-9968-000 – worldwide

Note

No power option is provided with this kit. The PoE+ mid-span power injector part numbers 451-0800-055 (North America) and 451-0800-155 (Europe and UK) are compatible with this camera. OneLINK devices are also compatible, and provide more flexibility in installation.

- DocCAM 20 HDBT camera
- Trim ring with mounting screws
- Tile support brace
- IR remote

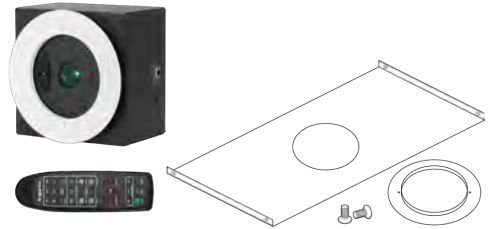

DocCAM 20 HDBT with OneLINK HDMI

999-9968-200 – North America

999-9968-201 – Europe/UK

- DocCAM 20 HDBT camera
- OneLINK HDMI Receiver kit – includes receiver, 48 VDC power supply and AC cord set(s)
- Trim ring with mounting screws
- Tile support brace
- IR remote



DocCAM 20 HDBT with OneLINK Bridge

999-9968-300 – North America

999-9968-301 – Europe/UK

- DocCAM 20 HDBT camera
- OneLINK Bridge AV Interface kit – includes AV interface, 48 VDC power supply and AC cord set for North America
- 3-position Phoenix-type connectors (qty. 4)
- USB 3.0 cable, type A to type B, 6 ft (1.8 m)
- Trim ring with mounting screws
- Tile support brace
- IR remote



A Quick Look at the Camera

The DocCAM 20 HDBT ceiling-mounted document camera is designed for recessed mounting. The features of interest during installation are not visible after the installation is complete.

Camera assembly numbers 998-9968-001 and 998-9968-100:

Class 1 Laser Product (IEC 60825-1:2014)

Produit Laser de la Classe 1 (IEC 60825-1:2014)

Klass 1 Laserprodukt (IEC 60825-1:2014)

Camera assembly numbers 998-9968-001 and 998-9968-100:

Note

This product contains a Class 1, 650 nm red laser pointer.

Cet appareil contient un pointeur laser de la Classe 1, à lumière rouge de 650 nm.

Camera assembly number 998-9968-000 only:

Caution

This product contains a Class 3 (5 mw) 650 nm red laser which produces visible laser radiation. Avoid direct eye exposure. Do not look at the laser aperture during camera operation.

All DocCAM 20 HDBT part numbers:

Caution | Avertissement

Laser light – Avoid direct eye exposure. Do not look at the laser aperture during camera operation.

Lumière de laser – Ne regardez pas directement dans le faisceau laser. Ne regardez pas directement dans l'ouverture laser lorsque la caméra est en marche.

Caution | Avertissement

Use of controls or adjustments or performance of procedures other than those specified herein may result in hazardous laser radiation exposure.

L'utilisation de commandes, réglages ou instructions autres que ceux spécifiés présente un risque d'exposition dangereuse aux radiations laser.

Features of Interest During Installation

- **Camera enclosure** – 8 x 8 x 5.1 inches (20.3 x 20.3 x 12.9 cm).
- **Bezel ring** – Extends 0.5 inch from the front face of the camera enclosure; includes threaded holes to attach the trim ring.
- **OneLINK/HDBaseT connector** – For power and all connectivity. When installed, the connector side points in the direction that the top of the document or other camera subject will face.
- **Fasteners for conduit box** – For installations that require all cabling to be routed through conduit. The conduit box is not supplied with this product.

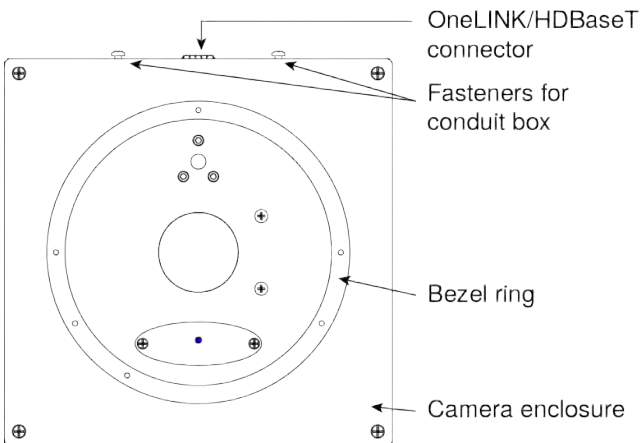

Connector Panel

The DocCAM 20 HDBT has one connector, the OneLINK/HDBaseT connector. When installed, the connector points in the direction of the top of the document or other camera subject – usually toward the audience.

The camera has no physical switches. Hardware configuration is via the web interface.

This is it: The Art of Easy.

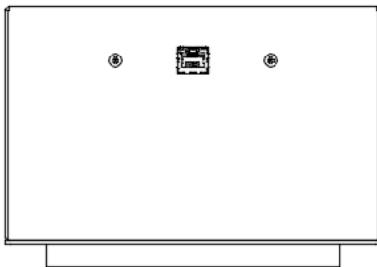

Features of Interest During Operation

In a typical installation, only the items inside the bezel ring are visible.

- **Camera lens** – 20x optical zoom lens for crisp detail.
- **Laser pointer** – Shows where the camera image is centered. Use the remote to turn on the laser pointer.

Caution | Avertissement

Laser light – Avoid direct eye exposure. Do not look at the laser aperture during camera operation.

Lumière de laser – Ne regardez pas directement dans le faisceau laser. Ne regardez pas directement dans l'ouverture laser lorsque la caméra est en marche.

- **IR window** – Sensors in the camera face receive signals from the remote. Point the remote toward the camera; precision is not necessary.
- **Status light** – The multicolored LED indicates the camera's current state.

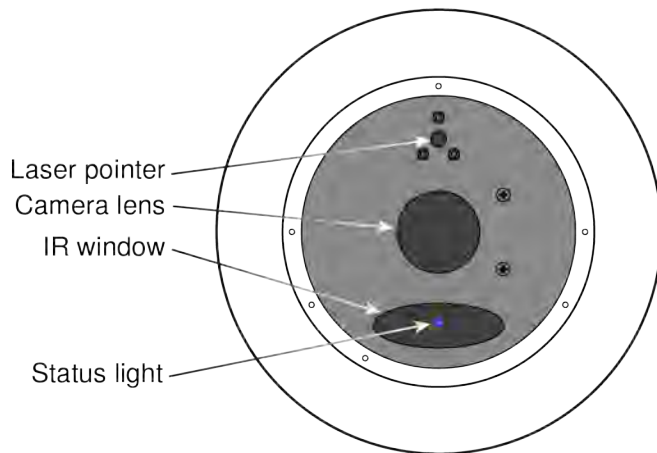

Caution | Avertissement

Laser controls are available to remote operators using the web interface. Keep your eyes out of the beam path.

Les commandes laser sont disponibles aux opérateurs à distance utilisant l'interface Web. Gardez les yeux hors du trajet du faisceau.

Installing the Camera

This section covers:

- Connections and pre-installation functional check
- Selecting the location for the camera
- Preparing the ceiling
- Installing the camera

Don't Void Your Warranty!

Caution

This product is for indoor use. Do not install it outdoors or in a humid environment without the appropriate protective enclosure. Do not allow it to come into contact with any liquid.

Do not install or operate this product if it has been dropped, damaged, or exposed to liquids. If any of these things happen, return it to Vaddio for safety and functional testing.

Use the power supply, power injector, or camera extension device included with or recommended for use with this product. For products with power supplies, using the wrong power supply will void the warranty, and could create unsafe operating conditions or damage the product. Note that power supplies for different products may look nearly identical – always check the label for the output voltage.

Cabling Notes

Use Cat-5e or better cable and standard RJ-45 connectors (568B termination). We recommend using high-quality connectors and a high-quality crimping tool.

Caution

Check Cat-5 cables for continuity before using them. Using the wrong pin-out may damage the camera system and void the warranty.

Note

Use standard RJ-45 connectors and a good crimping tool. Do not use pass-through RJ-45 connectors. Poorly terminated cables can damage the connectors on the product, cause intermittent connections, and degrade signal quality. Test cable pin-outs and continuity before connecting them.



Intact – will make reliable contact with cable connector



Damaged – Bent contact fingers will NOT make reliable contact with cable connector



Pro Tip

To prevent tragic mishaps, label both ends of every cable.

Pre-Installation Functional Check

Before you install the camera, verify that it powers up and sends video. Referring to the basic connection diagrams, connect the camera and verify that video is available on the connected display.

When you have verified that the camera operates properly, disconnect it and continue with the installation.

Camera assembly numbers 998-9968-001 and 998-9968-100:

Note

This product contains a Class 1, 650 nm red laser pointer.

Cet appareil contient un pointeur laser de la Classe 1, à lumière rouge de 650 nm.

Camera assembly number 998-9968-000 only:

This product contains a Class 3 laser.

All DocCAM 20 HDBT part numbers:

Caution | Avertissement

Laser light – Avoid direct eye exposure. Do not look at the laser aperture during camera operation.

Lumière de laser – Ne regardez pas directement dans le faisceau laser. Ne regardez pas directement dans l'ouverture laser lorsque la caméra est en marche.

Caution | Avertissement

Use of controls or adjustments or performance of procedures other than those specified herein may result in hazardous laser radiation exposure.

L'utilisation de commandes, réglages ou instructions autres que ceux spécifiés présente un risque d'exposition dangereuse aux radiations laser.

Basic Connection Diagram

The diagram below shows basic connections with a OneLINK Bridge AV Interface providing camera power, control, and video from the camera to other devices.

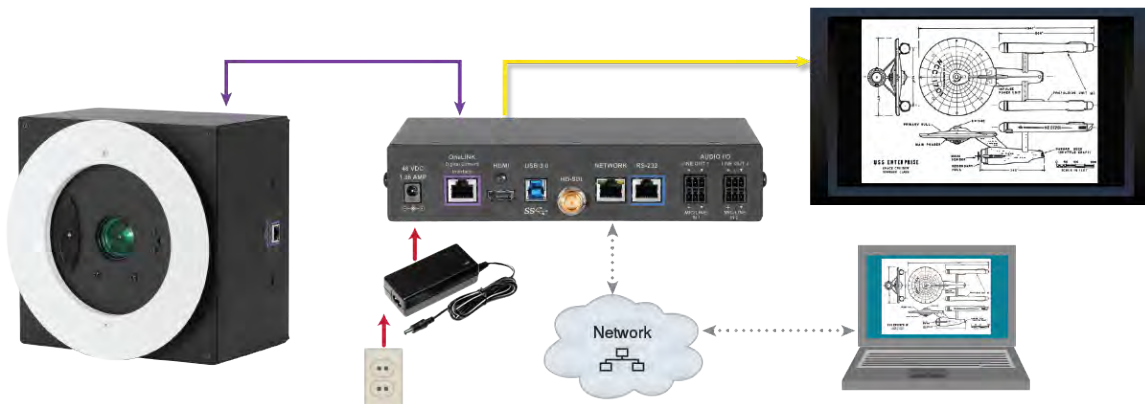

Note

The OneLINK device is recommended but not required; the camera can be connected directly to a third-party device with a PoE+ power injector (not provided). PoE+ mid-span power injector part numbers 451-0800-055 (North America) and 451-0800-155 (Europe and UK) are compatible with this camera.

Options for Power and Other Connections

Connect the camera to a OneLINK HDMI or a OneLINK Bridge AV Interface – a single Cat-5e (or better) cable provides power to the camera, along with HDBaseT network and video connectivity. Network, video output, and RS-232 control are connected at the OneLINK device. The OneLINK Bridge also provides audio connections.

Use a PoE+ power injector – Connect to a third-party control device through a PoE+ power injector (not provided). Power injector part numbers 451-0800-055 (North America) and 451-0800-155 (Europe and UK) are compatible with this camera.

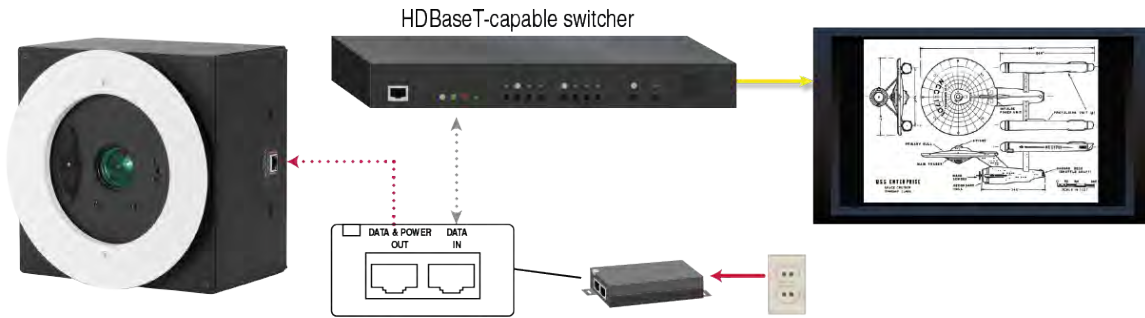

About Installation Height and Viewing Area

The camera may be installed in a ceiling up to 30 ft (9.1 m) high, depending on the desired viewing area.

When installed in a 9 ft (2.75 m) ceiling, such as a small classroom:

- Minimum viewing area is smaller than a business card
- Maximum viewing area is nearly 7 ft x 4 ft (over 2 m x 1 m)

When installed in a 30 ft (9.1 m) ceiling, such as a large lecture hall:

- Minimum viewing area is smaller than a sheet of letter-size or A4 paper
- Maximum viewing area is over 30 ft x 17 ft (over 9 x 5 m)

The Image Size Calculator on our website can help you to determine the minimum and maximum viewing areas with more precision.

Selecting the Installation Area

The DocCAM 20 HDBT can be installed in a suspended acoustic tile ceiling or in a wood or drywall ceiling. Total installed weight is roughly 5.1 lbs (2.3 kg).

Note

All above-ceiling work must conform to local building codes and should be performed by qualified personnel.

1. Use the plumb line to determine the ideal camera location, centered above the surface where documents or other objects will be placed, and mark the desired center.
2. Determine the exact alignment of the camera with respect to the intended subject.

Note

The image cannot be rotated. If installing in a hard ceiling, the camera cannot be rotated after installation.

3. Verify that the area above the ceiling where the camera is to be installed is clear of obstructions and provides enough room for the camera enclosure:
 - 8 inch by 8 inch (20.3 cm x 20.3 cm) footprint, aligned to the work surface where the camera's subject is placed
 - Minimum 5.6 inches of clear space above the opening to maneuver the camera into place

Things You Will Need for the Installation

Before you start, be sure you have what you need:

- Access to the area above the ceiling
- Plumb line
- Pencil
- Appropriate tools for cutting a hole in the ceiling
- #2 Phillips screwdriver
- Conduit box, if required
- Mounting kit 998-2225-152, if installing in a gypsum board (drywall) or other non-suspended ceiling

Installing the Camera in a Suspended Tile Ceiling

The camera is shipped with the ceiling mount for this type of installation.

The camera is mounted from above the ceiling, through a round hole, with only the bezel and the features inside it accessible from below. The camera rests on a support plate that distributes its weight across the ceiling tile; the support plate may also be suspended. A trim ring conceals the camera bezel and the adjacent portion of the ceiling tile.

Preparing the Tile Ceiling

Note

All above-ceiling work must conform to local building codes and should be performed by qualified personnel.

1. Remove the ceiling tile where the camera will be mounted.
2. Trace a 6.25 in. (15.9 cm) circle for the camera opening on the front side of the tile. You can use the tile support brace as a template.
3. Cut the camera opening.
4. Ensure that the camera's bezel ring fits into the opening. The bezel ring stands out 0.5 in (12.7 mm) from the camera face.
5. Place the tile back in the ceiling grid.
6. Place the tile support brace above the tile, aligning it to the hole in the tile.
7. Secure the tile support brace to the building structure using appropriate hardware such as Chief's "Speed Connect Hardware Kit," part number CMSHDW. The ends have holes to accommodate support wires.

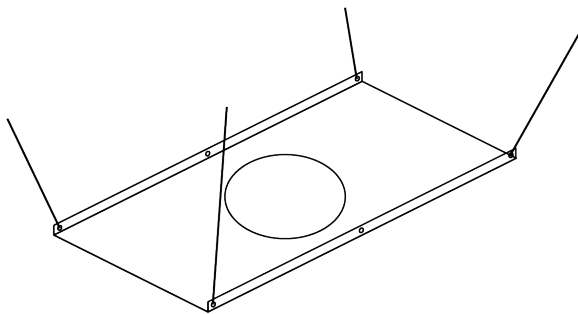

Completing the Installation in a Tile Ceiling

1. Connect the camera cable to the camera, routing it through a conduit box if required.
2. If using conduit, attach the conduit box to the camera enclosure using the threaded inserts on either side of the cable connector.
3. Seat the camera in place, with the bezel ring in the opening.
4. Rotate the camera so that the cable connector is facing the same direction as the top of the document or other photographic subject.
5. Secure the trim ring to the camera bezel ring using the screws provided with it.

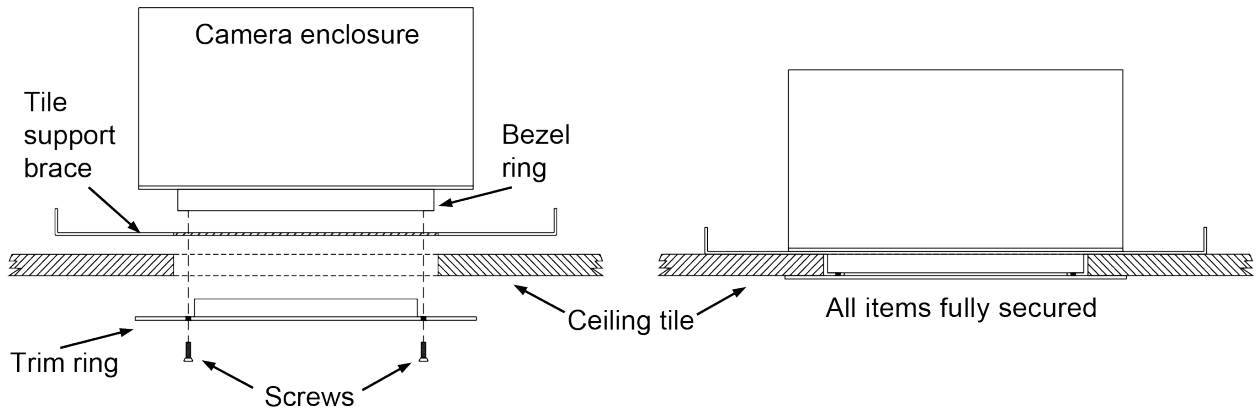

6. Connect the camera cable to the OneLINK device or customer-provided PoE+ power injector.

Note

After the camera is powered on, check the image and rotate the camera as needed to align it.

Installing the Camera in a Hard Ceiling

You will need mounting kit 998-2225-152 to install the camera in a gypsum board (drywall) or wood ceiling. *This mounting kit is not included with the camera.*

The camera is raised into place through a square hole in the ceiling, and attached from below using two mounting plates. A large trim ring conceals the portion of the camera enclosure outside the bezel and the camera mounting plates.

Preparing the Hard Ceiling

Follow these steps to mount the camera in a gypsum board or other non-suspended ceiling using Hard Ceiling Mounting Kit 998-2225-152.

Note

All above-ceiling work must conform to local building codes and should be performed by qualified personnel.

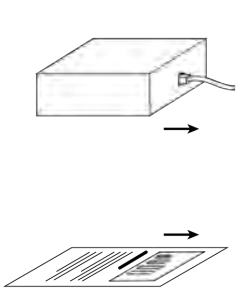

1. Determine the exact alignment of the camera with respect to the subject. The camera face with the connector must point in the same direction as the top of the document or other camera subject.
Note
The image cannot be rotated. Ensure that the camera opening is aligned precisely.
2. Trace a square, 8.125 x 8.125 inch (20.7 x 20.7 cm), for the camera opening.
3. Cut the camera opening.

Completing the Installation in a Hard Ceiling

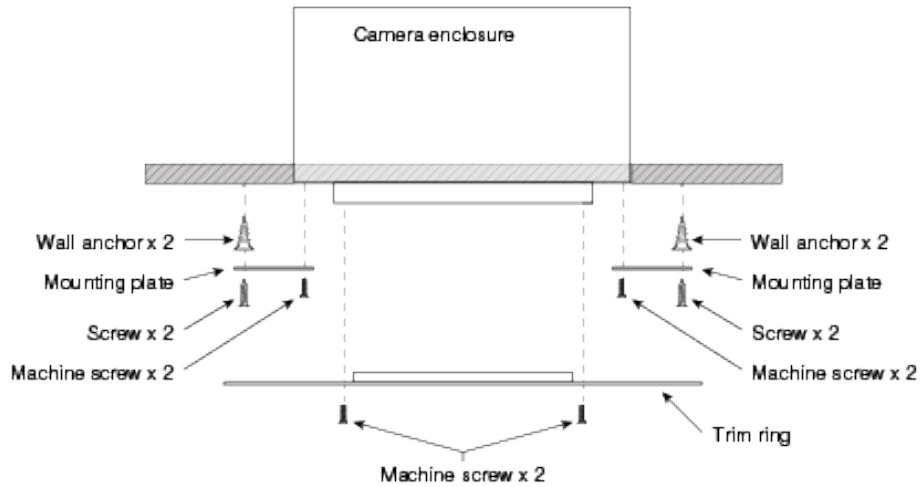

1. Attach the mounting plates to the camera with the black machine screws.
2. Lift the camera into place and mark the locations to drill into the ceiling.
3. Drill the holes and install the screw anchors.
4. Connect the camera cable to the camera, routing it through a conduit box if required.
5. Lift the camera into place and secure it with the 1 1/4 in. screws.
6. Attach the trim ring to the camera's bezel ring with the white machine screws.
7. Connect the camera cable to the OneLINK device or customer-provided PoE+ power injector.



Powering Up the Camera

Connect power to the OneLINK device or PoE+ power injector that supplies power and connectivity to the camera.

Note

Wait until the camera finishes initializing before trying to operate or control it.

The camera will take a few seconds to initialize. When the camera is ready, its status light is blue. At this point, video is available and the camera is ready to accept control information.

Camera assembly numbers 998-9968-001 and 998-9968-100:

Note

This product contains a Class 1, 650 nm red laser pointer.

Cet appareil contient un pointeur laser de la Classe 1, à lumière rouge de 650 nm.

Camera assembly number 998-9968-000 only:

Caution

This product contains a Class 3 (5 mw) 650 nm red laser which produces visible laser radiation. Avoid direct eye exposure. Do not look at the laser aperture during camera operation.

All DocCAM 20 HDBT part numbers:

Caution | Avertissement

Laser light – Avoid direct eye exposure. Do not look at the laser aperture during camera operation.

Lumière de laser – Ne regardez pas directement dans le faisceau laser. Ne regardez pas directement dans l'ouverture laser lorsque la caméra est en marche.

Caution | Avertissement

Use of controls or adjustments or performance of procedures other than those specified herein may result in hazardous laser radiation exposure.

L'utilisation de commandes, réglages ou instructions autres que ceux spécifiés présente un risque d'exposition dangereuse aux radiations laser.

Caution | Avertissement

Laser controls are available to remote operators using the web interface. Keep your eyes out of the beam path.

Les commandes laser sont disponibles aux opérateurs à distance utilisant l'interface Web. Gardez les yeux hors du trajet du faisceau.

Status Light

The light in the camera's face indicates its current state.

Note

By default, the camera's status light is active during normal operation; however, it can be configured to remain off when the camera is powered up. The camera may be sending video even if the indicator light is off.

- **Blue:** Normal operation (blinks off momentarily when the camera receives a command from the remote)
- **Purple:** In standby mode or booting
- **Yellow:** Firmware update in progress – overrides status light configuration

Camera assembly numbers 998-9968-001 and 998-9968-100:

Note

This product contains a Class 1, 650 nm red laser pointer.

Cet appareil contient un pointeur laser de la Classe 1, à lumière rouge de 650 nm.

Camera assembly number 998-9968-000 only:

Caution

This product contains a Class 3 (5 mw) 650 nm red laser which produces visible laser radiation. Avoid direct eye exposure. Do not look at the laser aperture during camera operation.

All DocCAM 20 HDBT part numbers:

Caution | Avertissement

Laser light – Avoid direct eye exposure. Do not look at the laser aperture during camera operation.

Lumière de laser – Ne regardez pas directement dans le faisceau laser. Ne regardez pas directement dans l'ouverture laser lorsque la caméra est en marche.

Next Steps

The camera is now ready to configure and use. This information is available in the **Integrator's Complete Guide to the DocCAM 20 HDBT Ceiling-Mounted Document Camera**. It is also included in the **Configuration and Administration Guide for the DocCAM 20 HDBT Ceiling-Mounted Document Camera**, which covers only configuring and operating the camera and system administration.

Compliance Statements and Declarations of Conformity

Camera assembly numbers 998-9968-001 and 998-9968-100:

Camera assembly numbers 998-9968-001 and 998-9968-100:

Class 1 Laser Product (IEC 60825-1:2014)

Produit Laser de la Classe 1 (IEC 60825-1:2014)

Klass 1 Laserprodukt (IEC 60825-1:2014)

Camera assembly number 998-9968-000 only:

This product contains a Class 3 laser.

All camera assemblies

Compliance testing was performed to the following regulations:

FCC Part 15 (15.107, 15.109), Subpart B	Class A
ICES-003, Issue 54: 2012	Class A
EMC Directive 2014/30/EU	Class A
EN 55032: 2015	Class A
EN 55024: November 2010	Class A
KN24 2008 (CISPR 24: 1997 + A1: 2000 + A2: 2002)	Class A

Camera assembly numbers 998-9968-001 and 998-9968-100:

IEC 60950-1:2005 (2nd Edition); Am 1: 2009 + Am 2: 2013	Safety
EN 60950-1: 2006 + A11: 2009 + A1: 2010 + A12: 2011 + A2: 2013	Safety
IEC 60825-1: 2014 (3rd Edition)	Safety

FCC Part 15 Compliance

This equipment has been tested and found to comply with the limits for a Class A digital device, pursuant to Part 15, Subpart B, of the FCC Rules. These limits are designed to provide reasonable protection against harmful interference when the equipment is operated in a commercial environment. This equipment generates, uses, and can radiate radio frequency energy and, if not installed and used in accordance with the instruction manual, may cause harmful interference to radio communications. Operation of this equipment in a residential area is likely to cause harmful interference in which case the user will be required to correct the interference at his/her own expense.

Operation is subject to the following two conditions: (1) This device may not cause interference, and (2) This device must accept any interference including interference that may cause undesired operation of the device.

Changes or modifications not expressly approved by Vaddio can affect emission compliance and could void the user's authority to operate this equipment.



ICES-003 Compliance

This digital apparatus does not exceed the Class A limits for radio noise emissions from digital apparatus set out in the Radio Interference Regulations of the Canadian Department of Communications.

Le présent appareil numérique n'émet pas de bruits radioélectriques dépassant les limites applicables aux appareils numériques de la classe A prescrites dans le Règlement sur le brouillage radioélectrique édicté par le ministère des Communications du Canada.



European Compliance

This product has been evaluated for Electromagnetic Compatibility under the EMC Directive for Emissions and Immunity and meets the requirements for a Class A digital device. In a domestic environment this product may cause radio interference in which case the user may be required to take adequate measures.

Standard(s) To Which Conformity Is Declared:



EMC Directive 2014/30/EU

EN 55032: 2015

Conducted and Radiated Emissions

EN 55024: November 2010

Immunity

EN 61000-4-2: 1995 + Amendments A1: 1998 + A2: 2001

Electrostatic Discharge

EN 61000-4-3: 2006 + A1: 2008

Radiated Immunity

EN 61000-4-4: 2004 + Corrigendum 2006

Electrical Fast Transients

EN 61000-4-5: 2006

Surge Immunity

EN 61000-4-6: 2009

Conducted Immunity

EN 61000-4-8: 2010

Power Frequency Magnetic Field

EN 61000-4-11: 2004

Voltage Dips, Interrupts and Fluctuations

KN24 2008 (CISPR 24: 1997 + A1: 2000 + A2: 2002)

IT Immunity Characteristics

EN 61000-4-2

Electrostatic Discharge

EN 61000-4-3

Radiated Immunity

EN 61000-4-4

Electrical Fast Transients

EN 61000-4-5

Surge Immunity

EN 61000-4-6

Conducted Immunity

EN 61000-4-8

Power Frequency Magnetic Field

EN 61000-4-11

Voltage Dips, Interrupts and Fluctuations

Camera assembly numbers 998-9968-001 and 998-9968-100:
IEC 60950-1: 2005 (2nd Edition); Am 1: 2009 + Am 2: 2013

Safety

Camera assembly numbers 998-9968-001 and 998-9968-100:
EN 60950-1: 2006 + A11: 2009 + A1: 2010 + A12: 2011 + A2:
2013

Safety

Camera assembly numbers 998-9968-001 and 998-9968-100:
IEC 60825-1: 2014 (3rd Edition)

Safety

Camera assembly number 998-9968-000 only: This product has not been evaluated for compliance with CE safety requirements.

Warranty Information

See Vaddio Warranty, Service and Return Policies posted on support.vaddio.com for complete details.

Hardware* warranty: Two (2) year limited warranty on all parts and labor for Vaddio manufactured products. Vaddio warrants its manufactured products against defects in materials and workmanship for a period of two years from the day of purchase, to the original purchaser, if Vaddio receives notice of such defects during the warranty. Vaddio, at its option, will repair or replace products that prove to be defective. Vaddio manufactures its hardware products from parts and components that are new or equivalent to new in accordance with industry standard practices.

Exclusions: The above warranty shall not apply to defects resulting from improper or inadequate maintenance by the customer, customers applied software or interfacing, unauthorized modifications or misuse, mishandling, operation outside the normal environmental specifications for the product, use of the incorrect power supply, modified power supply or improper site operation and maintenance. OEM and special order products manufactured by other companies are excluded and are covered by the manufacturer's warranty.

Vaddio Customer Service: Vaddio will test, repair, or replace the product or products without charge if the unit is under warranty. If the product is out of warranty, Vaddio will test then repair the product or products. The cost of parts and labor charge will be estimated by a technician and confirmed by the customer prior to repair. All components must be returned for testing as a complete unit. Vaddio will not accept responsibility for shipment after it has left the premises.

Vaddio Technical Support: Vaddio technicians will determine and discuss with the customer the criteria for repair costs and/or replacement. Vaddio Technical Support can be contacted by email at support@vaddio.com or by phone at one of the phone numbers listed on support.vaddio.com.

Return Material Authorization (RMA) number: Before returning a product for repair or replacement request an RMA from Vaddio's technical support. Provide the technician with a return phone number, e-mail address, shipping address, product serial numbers and original purchase order number. Describe the reason for repairs or returns as well as the date of purchase. See the General RMA Terms and Procedures section for more information. RMAs are valid for 30 days and will be issued to Vaddio dealers only. End users must return products through Vaddio dealers. Include the assigned RMA number in all correspondence with Vaddio. Write the assigned RMA number clearly on the shipping label of the box when returning the product. All products returned for credit are subject to a restocking charge without exception. Special order product are not returnable.

Voided warranty: The warranty does not apply if the original serial number has been removed or if the product has been disassembled or damaged through misuse, accident, modifications, use of incorrect power supply, use of a modified power supply or unauthorized repair.

Shipping and handling: Vaddio will not pay for inbound shipping transportation or insurance charges or accept any responsibility for laws and ordinances from inbound transit. Vaddio will pay for outbound shipping, transportation, and insurance charges for all items under warranty but will not assume responsibility for loss and/or damage by the outbound freight carrier. If the return shipment appears damaged, retain the original boxes and packing material for inspection by the carrier. Contact your carrier immediately.

Products not under warranty: Payment arrangements are required before outbound shipment for all out of warranty products.

Index

A

anatomy of the camera 3-5

B

behavior on power-up 13

C

cable connector 4, 6
camera power 8
capabilities 1
colors of the status light 14
connection example 7-8
connector identification 3

D

damage, preventing 6

I

indicator light 5, 14
 location 5
installation requirements 9-11
installation, typical 7, 11-12
 in gypsum board ceiling 12
 in tile ceiling 11

L

laser pointer 5
 location 5
location of connector 4

M

mounting kit for hard ceilings 10-11

O

OneLINK 7-8

P

packing lists 2
PoE+ power 8
power 8, 13
 on and off 13
 options 8
product capabilities 1
product returns and repairs 17

R

requirements, installation 9-11
RJ-45 connector 6

S

safety requirements 3, 6, 13-14
site requirements 9
status light, meanings of colors 14
structural requirements 9-11

T

typical installation 7, 11-12
 in gypsum board ceiling 12
 in tile ceiling 11

W

warranty 6, 17

Vaddio is a brand of Milestone AV Technologies · www.vaddio.com · Phone 800.572.2011 / +1.763.971.4400 · Fax +1.763.971.4464 · Email info@vaddio.com

Visit us at support.vaddio.com for firmware updates, specifications, drawings, manuals, technical support information, and more. Vaddio, RoboSHOT, and OneLINK are trademarks or registered trademarks of Milestone AV Technologies. HDBaseT™ and the HDBaseT Alliance logo are trademarks of the HDBaseT Alliance. Exmor® is a trademark of Sony Corporation. All other brand names or marks are used for identification purposes and are trademarks of their respective owners. In British Columbia, Milestone AV Technologies ULC carries on business as MAVT Milestone AV Technologies ULC.

©2018 Milestone AV Technologies

The logo for Vaddio, featuring the word "vaddio" in a bold, blue, lowercase sans-serif font. The final letter "o" is stylized as a thick blue circle with a smaller solid blue circle inside it, and a registered trademark symbol (®) is positioned to the upper right of the circle.