

ZIGEN

Zigen SW-41 Plus 4x1 HDMI Switch

4K 60 Hz 4:4:4
HDCP 2.2 & Auto Switching
ZigNet, Full Web Interface and System Diagnostics



18 GBPS
4K ULTRA HD

SW-41PLUS USER MANUAL

1. Do not use this product near water.
2. Do not block any ventilation openings. Install in accordance with the manufacturer's instructions.
3. Do not install or place this product near any heat sources such as radiators, heat registers, stoves, or other apparatus (including amplifiers) that produce heat.
4. Protect the power cord from being walked on or pinched particularly at plugs, convenience receptacles, and the point where they exit from the apparatus.
5. Only use attachments/accessories specified by the manufacturer.
6. To reduce the risk of electric shock and/or damage to this product, never handle or touch this unit or power cord if your hands are wet or damp. Do not expose this product to rain or moisture.
7. Unplug this apparatus during lightning storms or when unused for long periods of time.
8. Refer all servicing to qualified service personnel. Servicing is required when the apparatus has been damaged in any way, such as power-supply cord or plug is damaged, liquid has been spilled or objects have fallen into the apparatus, the apparatus has been exposed to rain or moisture, does not operate normally, or has been dropped.
9. Batteries that may be included with this product and/or accessories should never be exposed to open flame or excessive heat. Always dispose of used batteries according to the instructions.

Powered Product Warranty

Zigen, Inc. warrants its powered products against any defects in materials and workmanship for a period of three years from the date of invoice. Touchscreen displays carry a one year parts and labor warranty. If a malfunction occurs during the warranty period, Zigen, Inc. will repair or replace a product to its original operating condition. A return authorization number must be obtained from Zigen, Inc. before products are returned for service.

Non-Powered and Cable Products - Lifetime Limited Performance Warranty

Zigen, Inc. warrants that its non-powered products and cable products will be free from defects in material and workmanship for as long as you or your customer owns the product. All Zigen non-powered products and cables are designed and engineered to meet and exceed performance specifications. If, at anytime, the product fails due to manufacturer defect, Zigen will repair or replace the product to ensure that it meets original performance specifications. Reduced performance due to normal wear and tear, or damages caused by misuse or negligence will not be covered. Zigen will test and evaluate all non-powered and cable products claimed defective. Products must be shipped to Zigen, prepaid along with proof of purchase only after obtaining a Return Merchandise Authorization (RMA) number from the Zigen. This statement of policy is in lieu of any other policy expressed or implied and no representative or person is authorized to assume any other liability or adopt any other policy for Zigen without our written consent.

Return Policy

If you would like to return a Zigen product, it can be done within 30 days of purchase for a full refund, less shipping and handling. Zigen will not be responsible for shipping and handling of product returns. Returns will only be accepted of products with proof of purchase, products in the original packaging with zero to minimal use and a Return Merchandise Authorization RMA number provided by Zigen.

This product uses software that is subject to open source licenses, lwIP is licensed under the BSD license:

Copyright (c) 2001-2004 Swedish Institute of Computer Science.
All rights reserved.

Redistribution and use in source and binary forms, with or without modification, are permitted provided that the following conditions are met:

1. Redistributions of source code must retain the above copyright notice, this list of conditions and the following disclaimer.
2. Redistributions in binary form must reproduce the above copyright notice, this list of conditions and the following disclaimer in the documentation and/or other materials provided with the distribution.
3. The name of the author may not be used to endorse or promote products derived from this software without specific prior written permission.

This Software is provided by the author "as is and any express or implied warranties including, but not limited to, the implied warranties of merchantability and fitness for a particular purpose are disclaimed. In no event shall the author be liable for any direct, indirect, incidental, special, exemplary, or consequential damages (including, but not limited to, procurement of substitute goods or services; loss of use, data, or profits; or business interruption) However caused and on any theory of liability, whether in contract, strict liability, or tort (including negligence or otherwise) arising in any way out of the use of this software, even if advised of the possibility of such damage.

Technical Support

Tel: (818) 654-5252

Fax: (818) 654-5355

9:00AM - 500PM (PT)

Email

info@zigencorp.com

Web

www.zigencorp.com

Mailing Address

Zigen Corp.
c/o Customer Service
6934 Canby Avenue
Suite 107
Reseda CA 91335
USA

- 4x1 HDMI Switch
- HDMI 2.0a (18-GBPS UHD) on all ports.
- Full color depth support including 10,12,16 bit
- Supports digital video formats up to 4K UHD including:
2160p60 @ 4:4:4, 2160p60 @ 4:2:2, 2160p60 @ 4:2:0
- HDCP 2.2, 1.4 and Auto Switching
- ZigNet (Full Web Interface and System Diagnostics)
- Advanced EDID management
- All Zigen HDMI 4K 600Mhz video links exceed the IEC61000-4-2 (Level 4) ESD protection level
- ±15-kV Contact/Air Gap Discharge on External Lines
- Supports uncompressed PCM 2-Ch., 5.1, 7.1, Dolby Digital, DTS, Dolby TrueHD, DTS HD-Master Audio and more.
- Built in IR sensor plus 3.5mm jack and remote control
- Bi-directional RS-232 Control or integrate 3rd party control
- Equalizer
- Surround Sound Effect
- Bass Enhancement
- Audio De-embedding with tone controls and 5-band EQ
- EDID Management
- Video & Audio Diagnostics
- Humidity & Temperature Monitoring
- Hot Plug

The SW-41Plus, packaged with the following items:

- 1x 18-GBPS Ultra HD 4x1 Switch for HDMI w/ HDR
- 1x Universal 110/240-V 12V/2.5Amp Power Pack with 125V AC Power Cord
- 1x Hand-held IR Remote Control
- 1x CR2025 Lithium Cell 3V Battery
- 1x Quick Start Guide

If any of these products are not present upon first opening of the package, please contact Zigen or the dealer.

© 2017 Zigen, Corp. All Rights Reserved.

All trademarks are the property of their respective owners.
Zigen, Corp. reserves the right to make changes in the hardware, packaging,
and any accompanying documentation without prior written notice.



This product uses UL-Listed power supplies



Introduction

Front Panel	1
Back Panel	2
IR Remote Control	3

Get Started

Installation	4
Application Diagram	5
Using the Front Panel	6
Using the BackPanel	7
Using the Remote Control	8

Connection & Access

Connecting to ZigNet	9
Accessing ZigNet	10
RS-232 Configuration.....	11

System Control

Using ZigNet (Full Web Interface & System Diagnostics)	
Introduction to ZigNet	12
Navigation Bar	13
Control Page	14
AudioPage	15
Diagnostics Page	16
Admin Page	17-18
RS-232 Control	19

Appendix

Specifications	20-21
Diagnostics Specifications	22
Glossary	23

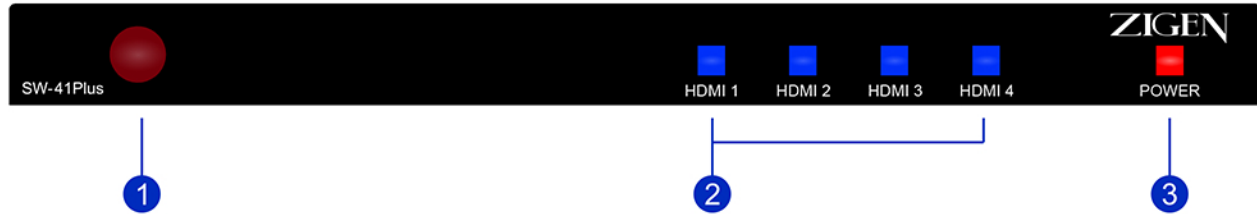

1 IR

This IR sensor receives signals from the included IR remote control unit.

2 HDMI Input Indicators 1-4

Each of these push button selectors represent an input on the rear panel of the switcher. When an input is selected it will glow bright blue. Other colors and flashing behaviors may occur for alert and diagnostic purposes.

3 Power

This push button will glow bright red when the included 12V DC power supply is connected to the SW-41Plus from an available electrical outlet. The function of the push button is to place the SW-41Plus in stand-by mode, or operating mode.

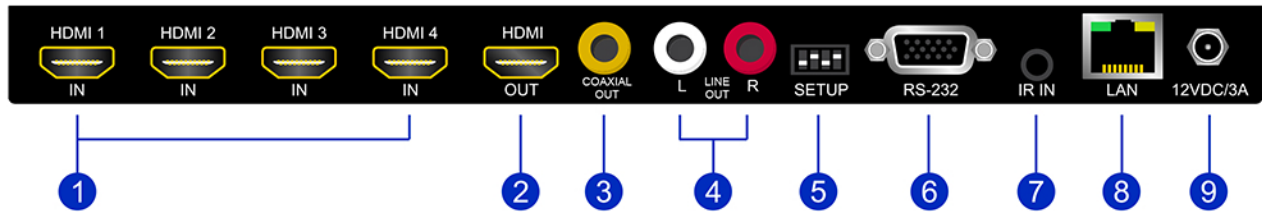

1 HDMI IN 1-4

Connect an HDMI cable from an HDMI source to each of the Input connectors as desired. The Zigen locking HDMI cable is recommended.

2 HDMI OUT

Connect an HDMI cable from this output port to your display. The SW-41Plus supports 1080p, 4K, and Ultra 4K resolutions. The Zigen locking HDMI cable is recommended.

3 COAXIAL OUT

This connector outputs S/PDIF audio.

4 LINE OUT L/R

Extracts audio to standard commercial line level stereo RCA connectors.

5 SETUP

DIP switches provide overrides for defaults or prior system settings. See Page 7 for details.

6 RS-232

Connect an RS-232 cable from this port to an RS-232 device.

7 IR IN

Connect an IR extender or electrical IR cable from an automation system to this port.

8 LAN

Connect an Ethernet cable between this jack and a LAN to use the ZigNet web control.

9 12V DC

Connect the included locking 12V DC power supply to this power receptacle.

The SW-41Plus IR remote control can be used for switching between inputs and powering the unit up or down.

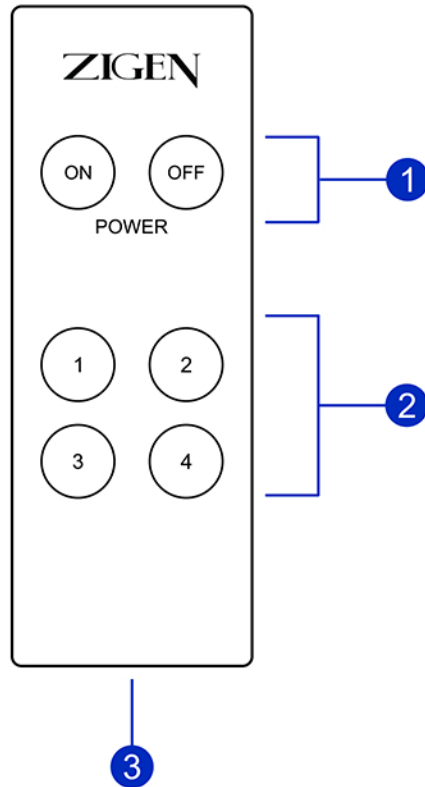

1 ON/OFF Button

Press these buttons to toggle between the operating modes. OFF will set the unit in Stand-By mode. ON will Reset the unit.

2 Input Buttons 1-4

Press these buttons to select the desired input when performing routing operations. Each button corresponds to an accompanying HDMI port (1-4) on the back panel of the switch.

3 Battery Compartment

Accepts one CR2025 Lithium Cell 3V Battery (included).

Video

1. Use an HDMI cable to connect up to four UltraHD sources to inputs (1-4) on the back panel of the unit. The Zigen locking HDMI cable is recommended for a sturdy connection.
2. Connect an HDMI cable to the Output 1 port on the back panel of the unit. The Zigen locking HDMI cable is recommended for a sturdy connection.

The HDMI cable can then be connected in any of the following ways:

- Connect the HDMI cable to an Ultra HD display.
- Connect the HDMI cable to another Zigen switch or splitter, for cascading purposes.

Power

3. Connect the included 12V DC locking power supply to the 12V DC power receptacle on the rear panel of the switch.
4. Connect the power supply to an electrical outlet.



Important: Cable quality is critical when handling 18 GBPS HDMI signals. Zigen HDMI cables are designed and tested to work at 18 GBPS and reliably transport the full 18 GBPS throughput of HDMI 2.0.

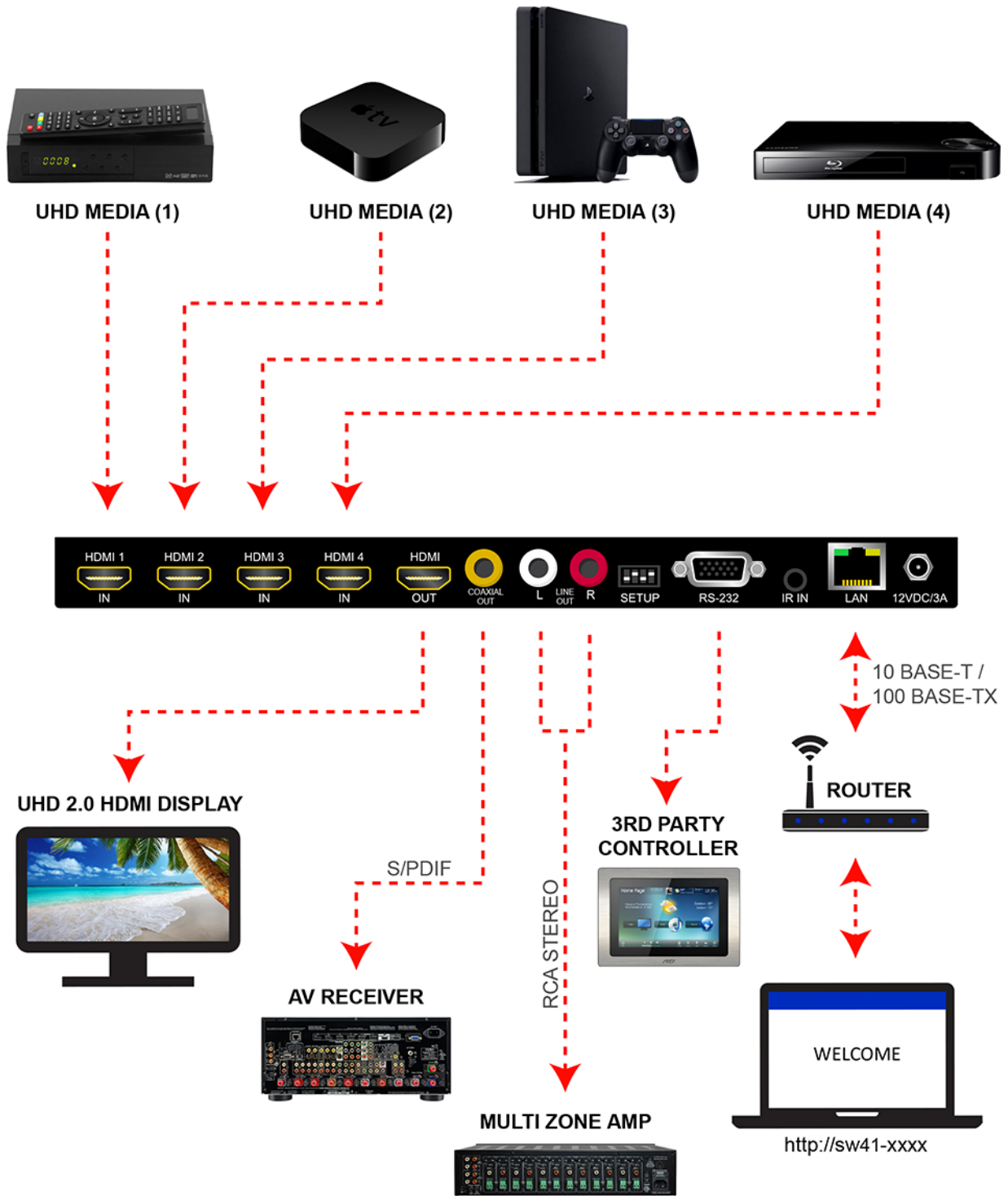

The front panel of the SW-41Plus has a set of four LED push button selectors which are associated with each HDMI input connector on the rear of the switch. Press the Input button to select the desired input.

1. When the SW-41Plus is powered-on for the first time, Input 1 will automatically be selected.
2. Under normal conditions, the four input selector buttons will illuminate the color blue when the corresponding input is selected. However, all input selectors will flash simultaneously if a fault condition is detected.
3. The button labeled Power will illuminate blue when pressed after connecting power to the unit. Pressing the button again will put the unit in stand-by and the button will illuminate the red.
4. The IR sensor shown on the Front Panel accepts infrared commands from the included remote control device.



The back panel of the SW-41Plus has a set of four DIP switches.

DIP switch explanations from left to right

1. DIP 1 is force Hot Plug Detect (HPD) enable. To enable set switch to down position.
2. DIP 2 is Ground Lift control. To lift ground from the Line Out Left/Right connectors set switch in the down position.
3. DIP 3 is downstream EDID control. To disable set switch to down position.
4. DIP 4 is Null Modem control. Toggle switch to reverse polarity.

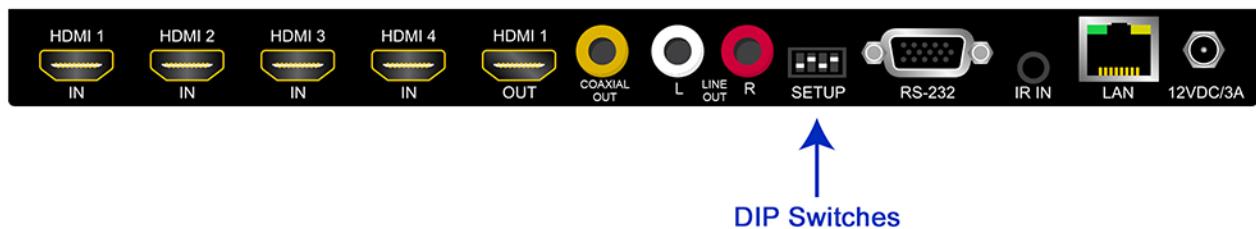

The included IR remote control is used to switch between HDMI inputs. The front panel of the SW-41Plus has a set of four LED indicators which are associated with each input on the switch.

1. When the SW-41Plus is powered-on for the first time, Input 1 will automatically be selected.
2. Point the IR remote control unit at the IR sensor on the front panel.
If an IR extender is being used, then both IR sensors will be used to receive IR signals.
3. Each numbered button on the IR remote control unit represents an input.
Press the desired source button on the IR remote control to switch to that input.

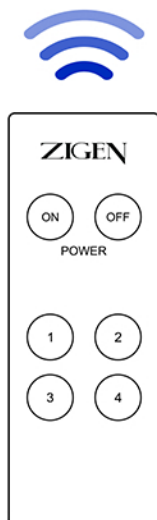

Network Setup Option 1:

Connect the unit and a computer into a router or switch.

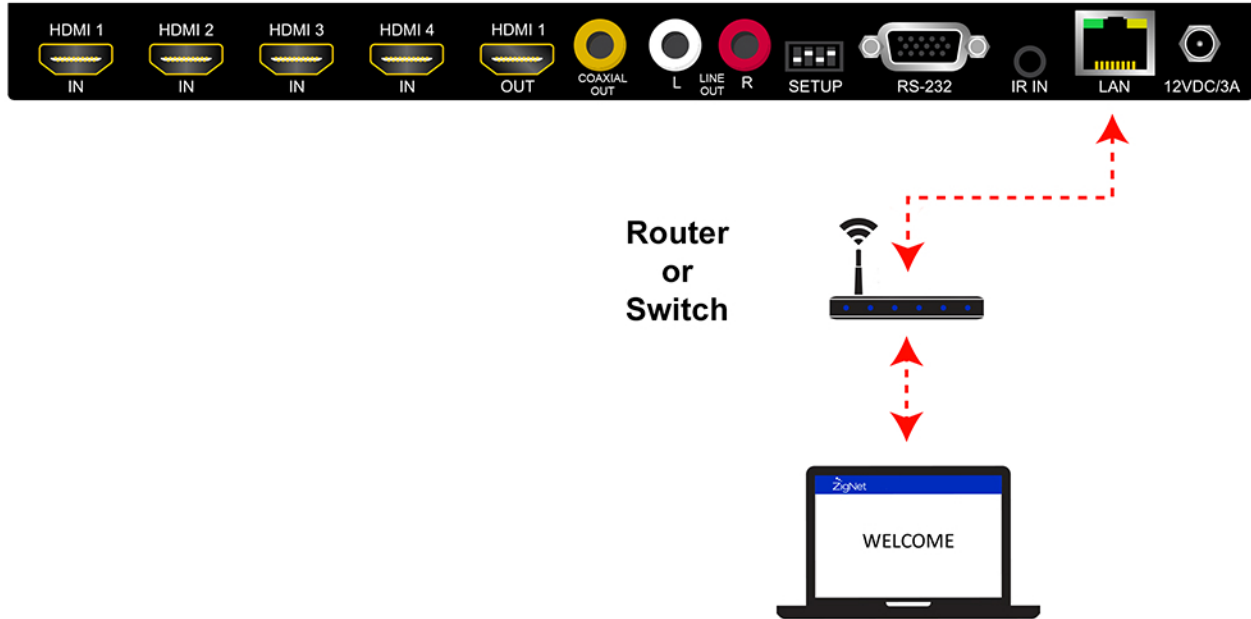

Network Setup Option 2:

Connect a computer directly into the unit by using an Ethernet crossover cable

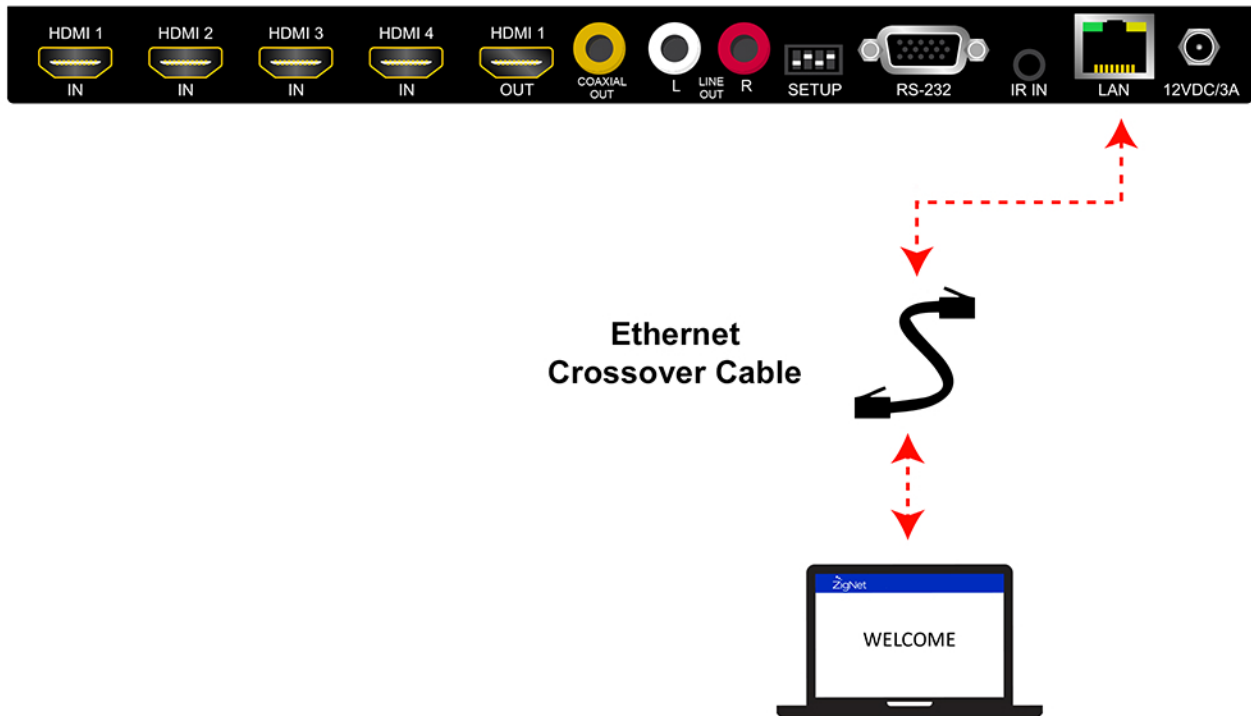

IP Address Retrieval

1. Open an RS-232 connection and power on the unit.
2. Upon power-up of the unit the IP address will be displayed on the RS-232 interface.
3. Open a web browser of your choice and insert the given IP address in the address bar.

Optional for Windows users: Skip steps 1-3 and type in the host name which is displayed on the bottom of the unit.

Requirements:

In order to retrieve the IP address of the Web Interface a valid RS-232 connection is required. For details on how to setup an RS-232 connection, see next page.

Configuring an RS-232 Connection

1. Connect the RS-232 port on the back of the SW-41Plus to a computer using an RS-232 cable.
2. Open a hyperterminal app of your choice (Putty recommended) on a computer.
3. Enter default settings shown below:

Baud Rate: 115200
Data Bits: 8
Stop Bits: 1
Parity: None
Flow Control: None

4. Your unit should now be connected.

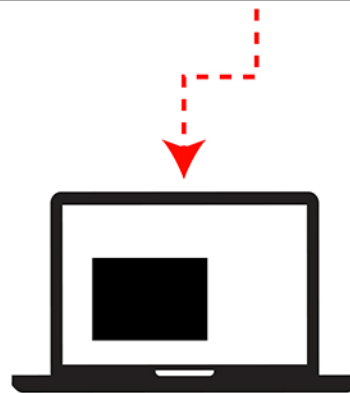

Introduction

ZigNet provides easy management of all features used by the SW-41Plus.

ZigNet is a highly functional web server that is accessible either remotely across the Internet or directly with a connection between a personal computer on a local area network, or a connection directly to the Ethernet connector on the back panel of the unit.

The following is the Welcome page for ZigNet, requesting login information.

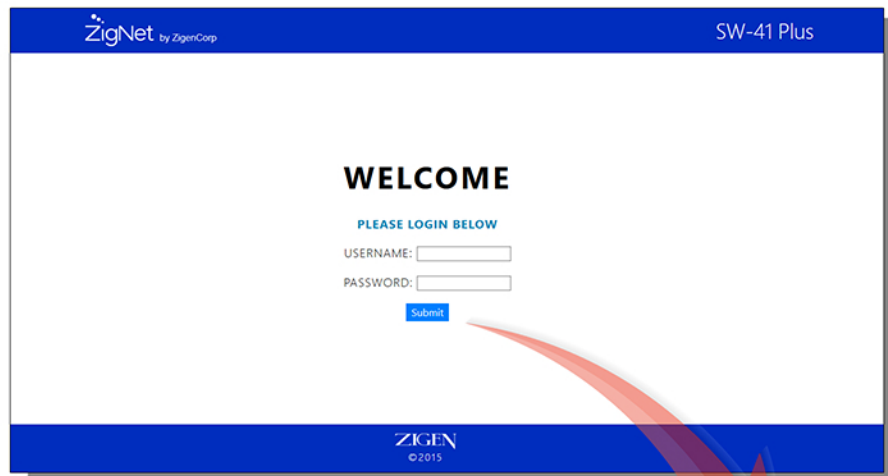

Logging In

1. Launch web browser.
2. Type the IP address of the unit in the address bar.
3. The login page will be displayed.
4. Enter Username and Password.
Default Username: admin
Default Password: Zigen
5. Press Submit.

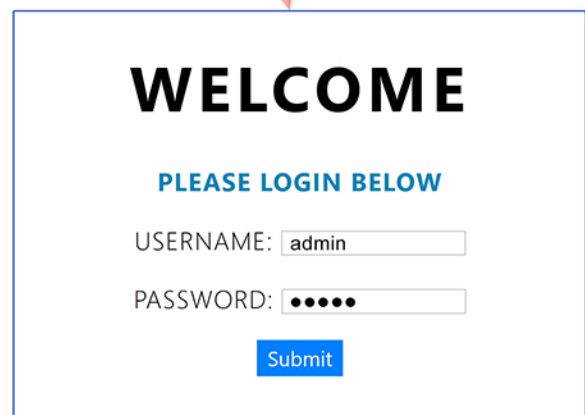

Navigation Bar

From the navigation bar, select the appropriate link to get to the corresponding page. The blue bar below the link indicates that the page is selected.



Control Page

Allows the user to switch the inputs for the outputs, change EDID settings and adjust audio settings.

Audio Page

Allows the user to manage audio settings.

Diagnostics Page

Allows the user to monitor video signals and system vitals.

Admin Page

Allows the user to change administration settings and save installation notes.

CONTROL PAGE

Switch

Click the desired input (source). The active Input is indicated by a blue bar.

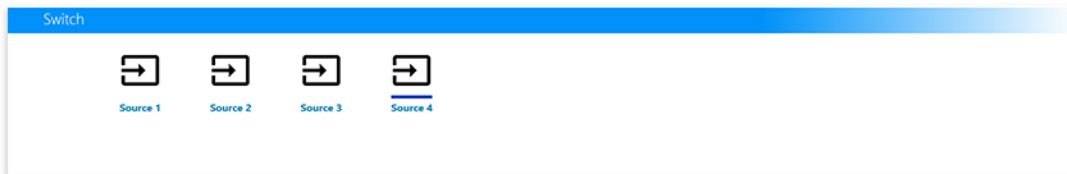

EDID Management

Active EDID

Displays the current EDID sent to the source.

Sink EDID

Displays the EDID available at the sink.

New EDID

Use the three drop down menus to select a new EDID configuration and press Set EDID.

Custom EDID

Press Browse to upload a custom EDID configuration. Select your custom EDID file and press Upload.

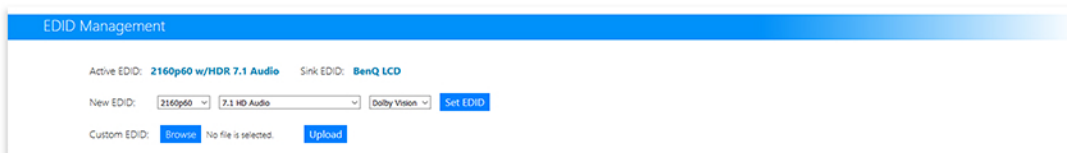

AUDIO PAGE

Global Settings: Enable or Disable ground lifting from the stereo RCA jacks.

Master Volume: Use slider and Mute button to control the output volume.

Audio Tuning

Presets

Select a preset to configure the parametric equalizer.

Graphical EQ

Use the sliders to configure dB levels for each band.

Tone Control

Use the sliders to set bass and treble.

Disable

By-pass digital tuning.

Surround Sound Effect: Use the toggle and slider to configure the surround sound effect.

Bass Enhancement: Use the drop down menus to configure the cut-off frequency and high-pass filter cut-off frequency. The high-pass filter can also be by-passed. Use the Bass Boost slider to set the bass levels. Use the Main Channel slider to set mix level.

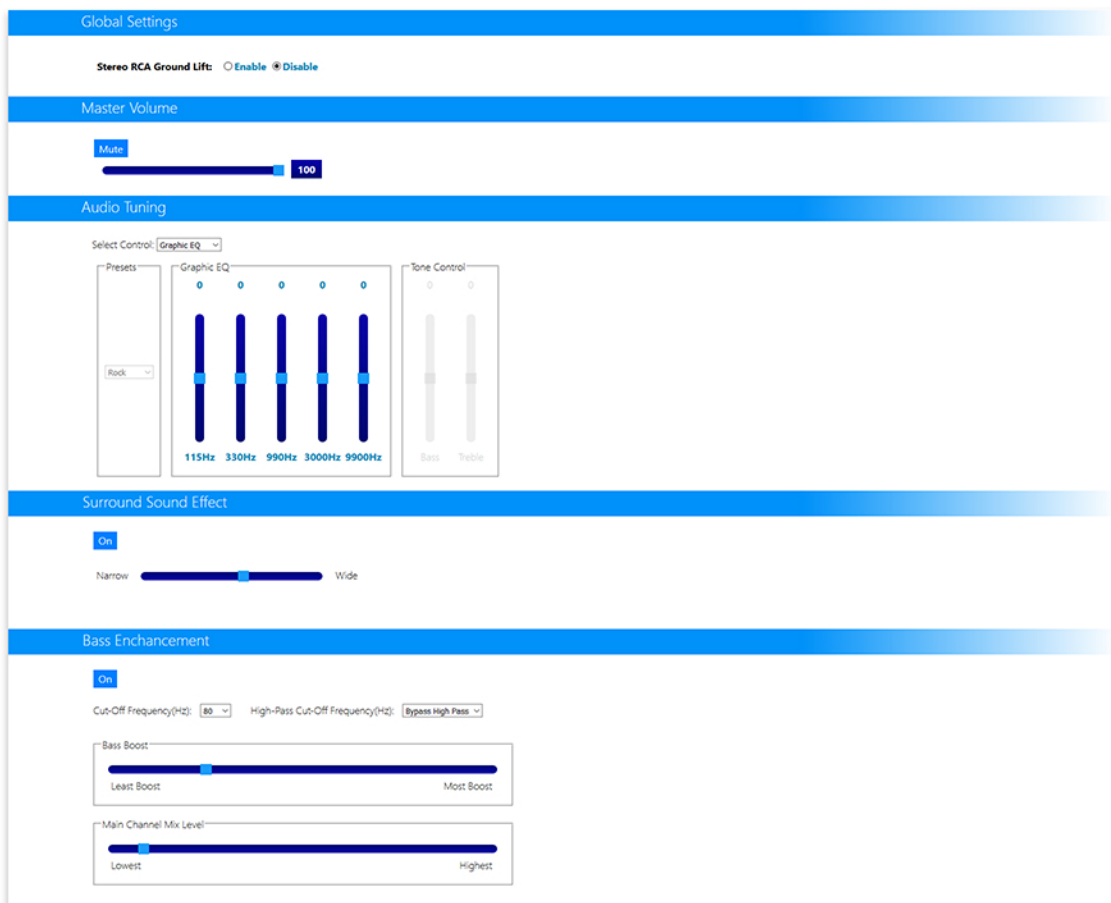

DIAGNOSTICS PAGE

Diagnostics displays the status and parameters of the HDMI Inputs, Outputs and the disposition of the system.

HDMI Inputs					
HDMI 1	HDMI 2	HDMI 3	HDMI 4		
Source:	Connected	Source:	Connected	Source:	Connected
Video Link:	Active	Video Link:	Active	Video Link:	Active
Source Type:	HDMI	Source Type:	HDMI	Source Type:	DVI
18G Signal:	No	18G Signal:	Yes	18G Signal:	Yes
HDCP Status:	Authenticated	HDCP Status:	Authenticated	HDCP Status:	No HDCP
HDCP version:	1.4	HDCP version:	2.2	HDCP version:	No HDCP
HDCP attempts:	1	HDCP attempts:	1	HDCP attempts:	0

HDMI Outputs	
HDMI 1	
Input Resolution:	1920x1080p
Output Resolution:	1920x1080p
Pixel Clock:	297 MHz
Colorspace:	YUV:444
Bit Width:	8
3D Video Format:	Frame
Audio Frequency:	32KHz
Audio Word Length:	24
Audio Format:	I2S
Audio Channels:	2 channels
Scan Type:	Progressive
Sink:	Connected
Video Link:	Active

System Monitoring	
5V Meter:	5.047 V
3.3V Meter:	3.293 V
1.1V Meter:	1.107 V
Runtime:	00:59:59
Temperature:	82 F
Humidity:	31%

See appendix on page 22 for detailed explanations of the parameters above.

ADMIN PAGE

User Notes

Allows the user to write and save notes for system configuration.



Device Settings and Information

Hostname: type desired host name and press Change Name.

Manual IP Address: Use these fields to change the IP address used in static IP mode and the IP address used in DHCP mode when no IP address can be obtained. Settings will take place after reset.

IP Mode: The IP mode allows selecting between DHCP and Static IP mode.

Firmware: Select browse to upload firmware updates.

Select the firmware update file and press Install Firmware. File type: *.bin

A progress bar will show upload transfer process. Once the transfer is complete the unit will reset itself and commence the update.

Factory Reset: Allows the unit to restore all settings back to factory defaults.

Restart: This feature will restart the unit.

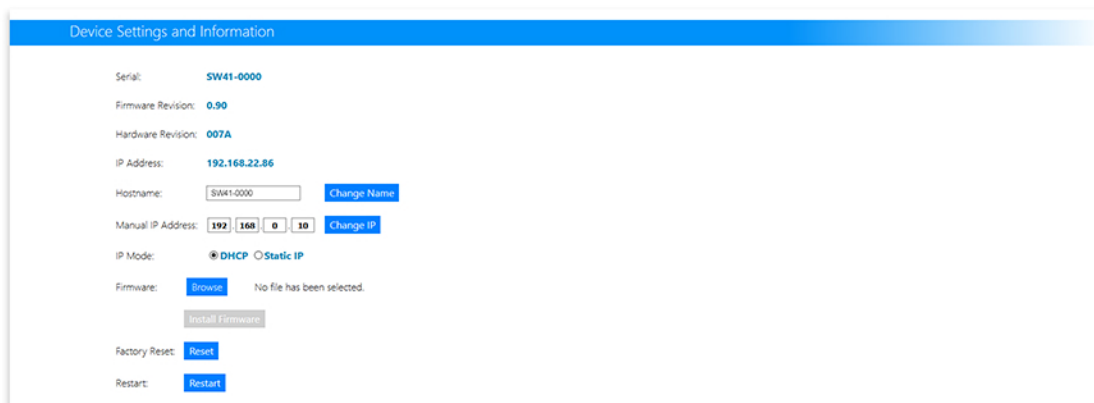

ADMIN PAGE

Change Password

To change the password, type the current password, the desired new password and confirm the new password.

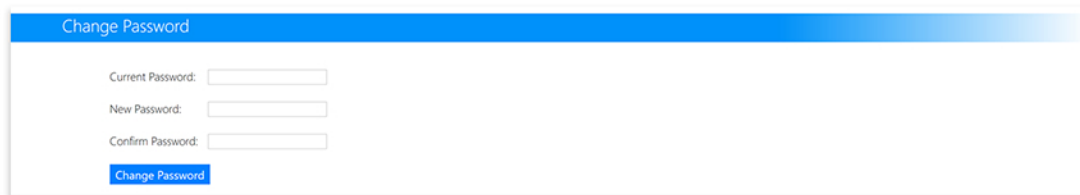

The screenshot shows a web form titled "Change Password" with a blue header bar. Below the header, there are three input fields: "Current Password:", "New Password:", and "Confirm Password:". Each field is followed by a small rectangular input box. At the bottom of the form, there is a blue button labeled "Change Password".

Command	Syntax	Description
Help	@SW41-xxxx help	Shows a list of available commands.
Uptime	@SW41-xxxx uptime	Shows elapsed time.
Version	@SW41-xxxx version	Shows product name, firmware release, version, build date and serial number.
Device Status	@SW41-xxxx st	Shows connected monitors and sources.
Input Select	@SW41-xxxx insel <1/2/3/4>	Lets you change the input.
Null Modem	@SW41-xxxx null <on/off>	Enables RS-232 null modem
Volume Up	@SW41-xxxx vol+	Increases the volume of the RCA output.
Volume Down	@SW41-xxxx vol-	Decreases the volume of the RCA output.
Set Volume	@SW41-xxxx vol <0-100>	Sets the volume of the RCA output.
Mute Toggle	@SW41-xxxx mutetogg	Enable/Disable mute of the RCA output.
Power	@SW41-xxxx help <on/off>	Powers the device on or off.

Replace “xxxx” with the serial number located on the bottom of your unit.

Command Combination Example:

“SW41-xxxx st uptime version”

Powering Device Command Example:

1. RS-232 Command Example

To power ON the SW-41Plus use command: @SW41-xxxx on \n

To power OFF the SW-41Plus use command: @SW41xxxx off \n

2. IP Command Example

To power ON the SW-41Plus use command: SW41-xxxx on \n

To power OFF the SW-41Plus use command: SW41-xxxx off \n

Video Bandwidth

18-GBPS

Video Resolutions

All SMPTE & VESA in HDMI 2.0 Specification

Max SMPTE UHD - 4096 x 2160P60/ RGB / 4:4:4

Color Space

RGB, YUV

Color Bit Depth

8-bit, 10-bit, 12-bit, & 16-bit per pixel

Note: Resolution and video bandwidth limitations: ex. 2160p60 RGB or 4:4:4 8-bit would use almost the entire 18-GBPS of bandwidth.

Chroma Subsampling

4:4:4, 4:2:2, 4:2:0

See note above – chroma subsampling or color compression is related to bit depth and video resolution settings with regard to total bandwidth requirements.

A 4K/60 signal at 4:4:4 chroma subsampling can have a maximum bit depth of 8 bits according to the HDMI 2.0 specification.

Audio

HDMI In & Out – Up to Dolby TrueHD and DTS-HD Master

SPDIF – Up to Dolby Digital & DTS 5.1

Line Level RCA Stereo Outputs

Distance

HDMI – Up to 5M @ 4K

HDCP

2.2, 1.4, or None

CEC

Pass through

Connections

- 4 x HDMI type A HDMI Input
- 1 x HDMI type A HDMI Output
- 1 x SPDIF Digital Audio Output
- 1 x Stereo RCA Jack
- 1 x RJ45 LAN Port for TCP/IP Control
- 1 x 9-pin RS-232 port
- 1 x 3.5mm IR In Port
- 1 x IR Sensor (In)
- 1 x 12 VDC Locking Connector

Temperature

Operating 32-122 F (0-50 C)
Humidity: 20-90% non condensing

Dimensions

0.86 x 3.70 x 10.76 inches
21.844 x 93.98 x 273.0754 millimeters

Weight

1.4 pounds
635 grams

Certifications/Compliance

FCC, CE, RoHS, HDCP, HDMI

This section details the parameters on the Diagnostics Page (pg.16).

Source: Indicates if a source is connected to the unit.

Video Link: Indicates if video is being passed from the source.

Source Type: Indicates if the source is connected through an HDMI or DVI interface.

18G Signal: Indicates if the HDMI signal being transmitted is greater than 3.4 GBPS.

HDCP Status: Indicates the HDCP authentication status.

HDCP version: Shows the HDCP version (2.2 / 1.4).

HDCP attempts: Show the number of times HDCP authentication has been attempted.

Input Resolutions: Displays the incoming resolution.

Output Resolutions: Displays the outgoing resolution.

Pixel Clock: Displays the Pixel Clock frequency.

Colorspace: Displays HDMI signal colorspace (RGB, YUV, etc).

Bit Width: Displays the bit width of the video (8, 10, 12 or 16 bit).

3D Video Format: Displays the 3D video format packing.

Audio Frequency: Displays the audio frequency (32, 44.1, 48, etc)

Audio Word Length: Display the length of the audio sample (16, 20, or 24 bits).

Audio Format: Displays audio format (PCM, S/PDIF, etc).

Audio Channels: Displays the number of channels in the audio.

Scan Type: Indicates whether the video is interlaced or progressive.

Sink: Indicates if a sink (monitor/TV) is connected.

Video Link: Indicates whether video is being sent to the sink or not.

12V Meter: Displays the voltage level from the power supply captured in real-time.

3.3V Meter: Displays the regulated 3.3 voltage in real-time.

1.1V Meter: Displays the regulated 1.1 voltage in real-time.

Runtime: Displays how long the unit has been running.

Temperature: Displays the temperature inside the box captured in real-time.

Humidity: Displays the humidity inside the box captured in real-time.

4:4:4 – Type of chroma subsampling. 4:4:4 defines 12 unique values of color per 4 pixels.

4:2:2 – Type of chroma subsampling. 4:2:2 defines 8 unique values of color per 4 pixels.

4:2:0 – Type of chroma subsampling. 4:2:0 defines 6 unique values of color per 4 pixels.

4K60 – defines a video format of 3840 x 2160 pixels at 60 Hz.

CEC – Consumer electronics control. A channel in the HDMI connection that allows consumer electronics to control other media.

S/PDIF – Digital audio interconnect delivering digital audio over a coaxial cable with RCA connectors.

DHCP – Dynamic Host Configuration Protocol is a standardized network protocol used to designate IP addresses to media.

DIP Switch – dual in-line package switch is a manual electric switch that is packaged with others in a group.

Dolby TruHD – High performance audio codec from Dolby.

DTS-HD Master – High performance audio codec from DTS.

EDID – Extended Display Information Data is used to relay specifications and capabilities of a sink device to a source device.

HDCP – High-bandwidth Digital Content Protection is a form of digital copy protection to prevent copying of digital audio and video content across connections.

HDMI – High Definition Multimedia Interface is a proprietary audio/video interface for transmitting video data and audio data.

HDR – High Dynamic Range refers to a technique in imaging to reproduce a greater range of luminosity.

HPD – Hot plug detect is a signal in the HDMI interface that allows a sink device to notify a source that a connection is valid.

IR – Infrared

LAN – Local Area Network.

Null Modem – Null modem is referred to as a device or implementation that allows the receiver and transmitter lines of the RS232 protocol to be swapped.

RCA – also called a phono connector is an electrical connector used to carry audio and video signals.

RGB – A color format in which color data is represented as a combination of Red, Green, and Blue.

RS-232 – RS-232 is a standard for serial communication transmission of data. It is commonly used with a DB-9 connector.

SMPTE – SMPTE is a foundation that has set standards for television and digital cinema formats. In this manual it is used to refer to cinema formats such as 4096 x 2160.

Static IP – In contrast to DHCP, static IP refers a to unit or device that has a set IP address and configured to attempt connect with the predefined IP address.

UHD – Ultra High Definition. This is commonly referred to the video format 3840 x 2160.

VESA – Video Electronics Standards Association is a technical standards organization for computer display formats.

ZigNet – Proprietary web control developed by Zigen, Inc.