

# V2Digital Mini-Converter

## Analog to HD/SD-SDI

# Installation & Operation Guide

Version 2.2

Published: February 17, 2015



Because it matters.®

**AJA**  
VIDEO SYSTEMS

# Table of Contents

---

<b>Notices</b> .....	<b>4</b>
Trademarks .....	4
Copyright .....	4
Contacting Support .....	4
<b>Chapter 1: Introduction</b> .....	<b>5</b>
Features .....	5
Block Diagram .....	6
I/O Connections .....	6
User Controls .....	6
External DIP Switches .....	7
MiniConfig Control .....	7
Installation .....	7
<b>Chapter 2: Operation</b> .....	<b>8</b>
Default Operational Settings .....	8
DIP Switch Settings .....	8
DIP Switch Settings Summary .....	9
USB Control and Setup—Using AJA MiniConfig .....	9
Installing MiniConfig on a Mac .....	9
Installing MiniConfig on a PC .....	10
Running MiniConfig .....	10
Operating MiniConfig .....	11
Tabbed Screens .....	12
Input Tab Screen .....	13
Update Tab Screen .....	14
Software Update Procedure .....	14
Info Tab Screen .....	15
MiniConfig Settings Summary .....	16
<b>Appendix A: Specifications</b> .....	<b>17</b>
Video Input .....	17
Input Formats .....	17
Video Output .....	17
User Controls .....	17
Physical .....	17
Power .....	17
Size .....	17
Environment .....	17
<b>Appendix B: Safety and Compliance</b> .....	<b>18</b>
Federal Communications Commission (FCC) Compliance Notices .....	18
Class B Interference Statement .....	18
FCC Caution .....	18
Canadian ICES Statement .....	18
European Union and European Free Trade Association (EFTA) Regulatory Compliance .....	19
Declaration of Conformity .....	19
Korea KCC Compliance Statement .....	20
Taiwan Compliance Statement .....	20
Japanese Compliance Statement .....	20

Translated Warning and Caution Messages.....	20
Before Operation Please Read These Instructions.....	21
<b>Warranty Information .....</b>	<b>28</b>
Limited Warranty.....	28

# Notices

---

## Trademarks

---

AJA®, Io®, Ki Pro®, KONA®, KUMO®, T-TAP®, Because it matters.® and ROI® are registered trademarks of AJA Video Systems, Inc. in the United States. AJA and Ki Pro are trademarks of AJA Video Systems, Inc. registered in other countries. AJA Control Room™, CION™, Corvid Ultra™, FiDO™, Science of the Beautiful™, TruScale™, TruZoom™, V2Analog™ and V2Digital™ are trademarks of AJA Video Systems, Inc.

AirPort, Apple, Apple logo, AppleShare, AppleTalk, FireWire, iPod, iPod touch, Mac and Macintosh are registered trademarks of Apple Inc. Final Cut Pro, QuickTime and QuickTime logo are trademarks of Apple Inc.

Avid, Avid DNxHD and Media Composer are registered trademarks of Avid Technology, Inc.

HDMI, the HDMI logo and High-Definition Multimedia Interface are trademarks or registered trademarks of HDMI Licensing, LLC.

DVI is a registered trademark of DDWG.

TASCAM is a registered trademark of TEAC Corporation.

Dolby® and the double-D Dolby logo are registered trademarks of Dolby Laboratories Licensing Corporation.

All other trademarks are the property of their respective holders.

## Copyright

---

Copyright © 2015 AJA Video Systems, Inc. All rights reserved. All information in this manual is subject to change without notice. No part of the document may be reproduced or transmitted in any form, or by any means, electronic or mechanical, including photocopying or recording, without the express written permission of AJA Video Systems, Inc.

## Contacting Support

---

When calling for support, have all information at hand prior to calling.

To contact AJA for sales or support, use any of the following methods:

*Telephone:* +1.530.271.3190

*FAX:* +1.530.271.3140

*Web:* <http://www.aja.com>

*Support Email:* [support@aja.com](mailto:support@aja.com)

*Sales Email:* [sales@aja.com](mailto:sales@aja.com)

# Chapter 1: Introduction

---

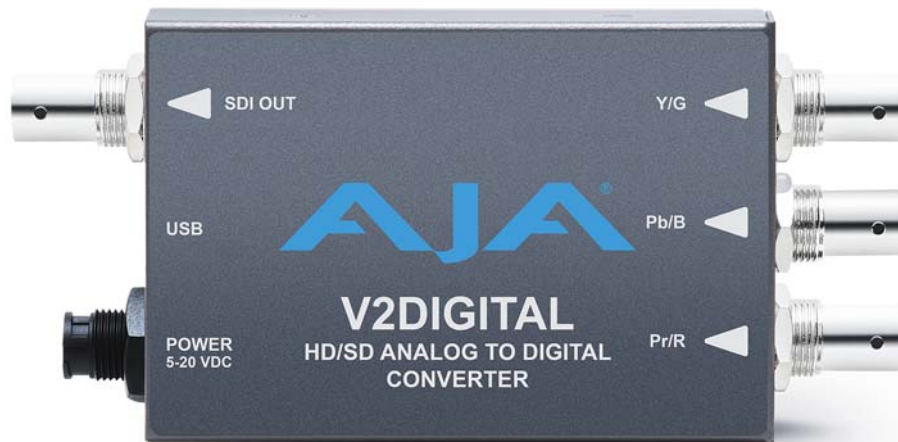

V2Digital is a high-quality, cost-effective analog to digital video converter that's perfect for facilities needing to integrate signal types. V2Digital provides AJA's high-quality 10-bit conversion of component or composite analog video to SDI at either SD or HD resolutions utilizing a full 10-bit data path and 2x oversampling to ensure a quality conversion all at an extraordinary price. V2Digital accepts YPbPr (SMPTE/EBU-N10), Betacam, or RGB component inputs (HD only) or NTSC/PAL or Y/C (S-Video) composite inputs (SD only). Configuration can be set by on unit DIP switches or remotely via AJA MiniConfig software control over USB.

*NOTE: The V2Digital requires a Time Base Corrected source. Operation is not recommended from VTRs, laser disks, etc., without Time Base Correction (TBC).*

## Features

---

- 10-bit AJA quality Analog to Digital conversion
- Low power, compact size
- YPbPr/RGB Component or Composite input
- HD/SD-SDI output
- Configurable by DIP switches, or with AJA MiniConfig software for Mac and PC via USB
- DWP-U-R1 Power Supply Included
- 5-year warranty

# Block Diagram

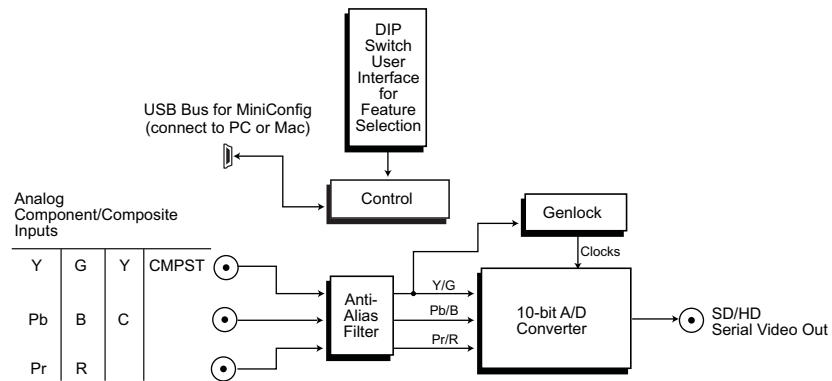

# I/O Connections

Figure 1. V2Digital, Side View

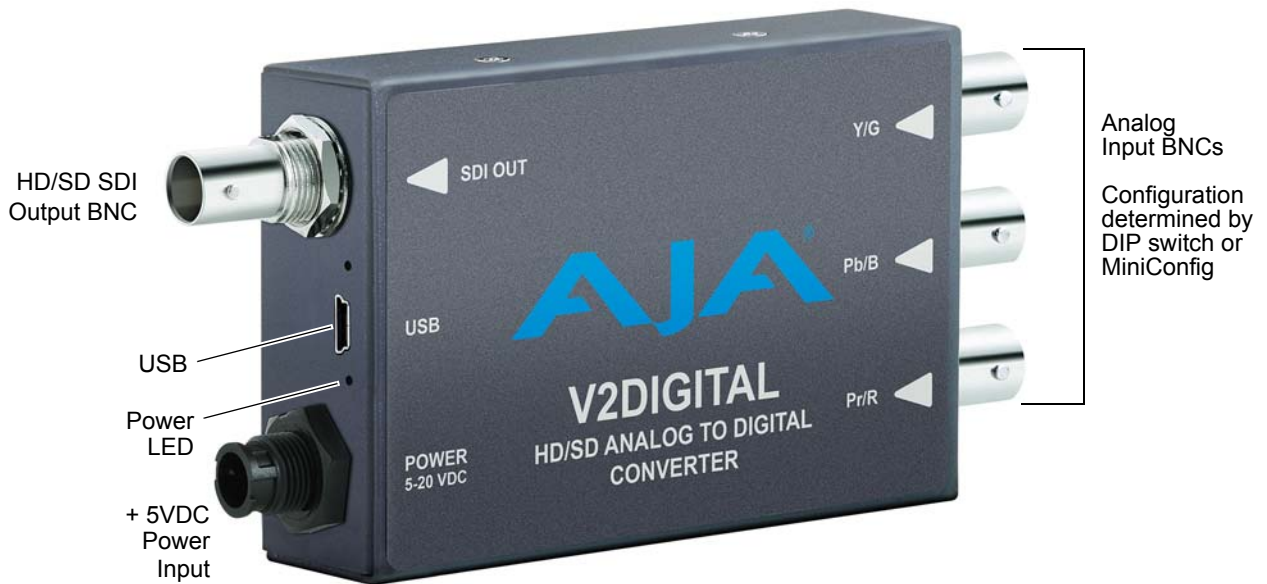

# User Controls

The V2Digital converter has two user interfaces:

- DIP switch settings
- MiniConfig via USB

The DIP switch 1 setting determines which configuration parameters the converter will use. When Off the unit is set to Local, DIP switches 2-4 will be active. When On the unit is set to Remote and will use the MiniConfig settings. MiniConfig settings are non-volatile and are retained through power cycles.

**NOTE:** The Beta-J parameter is not available through the DIP switch interface. Use MiniConfig if you need to use the Beta-J format.

## External DIP Switches

The V2Digital has a 4-switch DIP accessible through a cut-out in the bottom of the unit. For specific DIP switch setting information, see [“DIP Switch Settings” on page 8](#).

## MiniConfig Control

MiniConfig is an AJA application used for configuring and updating the firmware of several AJA products. Configuration set via MiniConfig is stored in the unit through subsequent power cycles. See [“USB Control and Setup—Using AJA MiniConfig” on page 9](#).

## Installation

---

Typically, V2Digital installation consists of the following:

1. Disconnect power from the converter.
2. Configure the DIP switches for the desired equipment configuration and video formats.
3. Connect video equipment to the converter BNCs.
4. Apply power to the converter (AJA power supply included).

Alternatively, you can set the unit to Remote operation using DIP switch 1, connect the unit to a PC or Mac via USB, and then use MiniConfig to configure the unit. The MiniConfig application is available for download from the AJA website.

*NOTE: Threaded holes (unified 4-40) located on the bottom of the unit can be used for mounting.*

# Chapter 2: Operation

## Default Operational Settings

The V2Digital converter ships from the factory with the following configuration:

- Local (DIP switch) control
- Component video input
- YPbPr format
- Pedestal Off

If these settings apply to your requirements, you can simply connect the video input and output signal cables and power up the V2 Digital unit.

For other applications, you can configure the unit using its DIP switch settings, or by using MiniConfig and a PC or Mac via USB. When configured for “component” V2DIGITAL will auto detect between various component standards.

## DIP Switch Settings

Four DIP switches are located on the bottom of the unit. The label on the bottom of the unit identifies the functions of the switch positions. The default shipping position for these switches is Off (down). By default, DIP switch configuration is enabled, and MiniConfig control is disabled.

Use a pen-point or paper clip to change DIP switch positions.

**Figure 2. DIP Switches.**

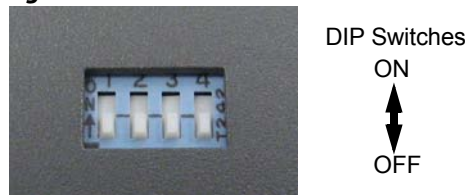

**Table 1. DIP Switch Setting Descriptions**

SWITCH	FUNCTION	OFF (Down)	ON (Up)
1	Control	Selects Local (DIP), and blocks MiniConfig control	Selects Remote (MiniConfig), and disables DIP switches 2-4.
2	Input	Selects Component	Selects Composite
3	Color Space	Selects YPbPr in Component mode, S-Video in Composite mode	Selects RGB in Component mode, Composite in Composite mode
4	Pedestal	Selects Off	Selects On

**NOTE:** *BetaJ is only accessible via MiniConfig.*



## DIP Switch Settings Summary

DIP switch settings for various input analog formats are shown in [Table 1](#).

**Table 1. Input Analog Format DIP Switch Settings**

Input Standard	Input Analog Format	DIP Switch Settings			Notes
		2	3	4	
525i59.94	Composite NTSC	ON	ON	ON	
	NTSC S-Video	ON	OFF	ON	
	Composite NTSC-J	ON	ON	OFF	
	NTSC-J S-Video	ON	OFF	OFF	
	Component YPbPr SMPTE/EBU-N10	OFF	X	OFF	
	Component YPbPr Betacam	OFF	X	ON	
	Component YPbPr Betacam-J	-	-	-	only selectable via MiniConfig
625i50	Composite PAL + S-Video	ON	ON	X	
	PAL S-Video	ON	OFF	X	
	Component YPbPr SMPTE/EBU-N10	OFF	X	X	
720p *	Component YPbPr SMPTE/EBU-N10	X	OFF	X	
	Component RGB	X	ON	X	
1080i/psf *	Component YPbPr SMPTE/EBU-N10	X	OFF	X	
	Component RGB	X	ON	X	
* = all supported frame rates		Note: X = don't care			

## USB Control and Setup—Using AJA MiniConfig

The V2Digital can usually be used right out of the box for most applications since it is designed to recognize inputs and perform standard actions automatically by default. However you can also manually configure the V2Digital using a supplied software application for PCs and Macs called “MiniConfig.” This same application can be used to update Mini-Converter firmware released by AJA.

### Installing MiniConfig on a Mac

To install the application on a Mac, insert the CD supplied with the Mini-Converter into the computer, drag the “AJA MiniConfig” application for your platform (Mac or PC) to your desktop or an applications folder.



AJA MiniConfig

**NOTE:** *Macintosh computers must be Intel-based (G5, G4 and earlier models will not work with MiniConfig).*

## Installing MiniConfig on a PC

To install the application on a Windows PC, insert the CD supplied with the Mini-Converter into the computer, locate the “MiniInstaller” application, and then double-click it.

**Figure 3. MiniConfig Setup Wizard on PC**



A Setup Wizard will guide you through the installation. Just click Next to begin.

Answer all questions in the subsequent dialogues; when done, you will be able to locate the MiniConfig application in the AJA folder in the Programs listing.

## Running MiniConfig

Connect the Mini-Converter to the PC or Mac via the supplied USB cable. Connect the external power supply (supplied) to the Mini-Converter.

*NOTE:* On a Mac, when the Mini-Converter is connected to the USB port, you may see an alert like that shown following. If you do, press Cancel—this alert can be ignored.

**Figure 4. Mac Network Message (ignore)**

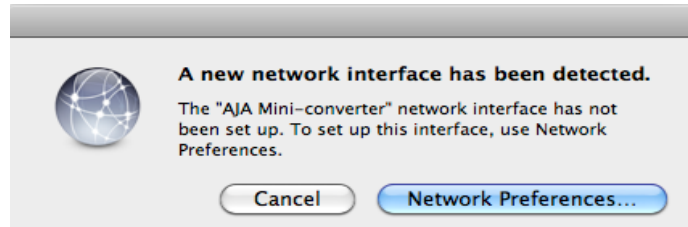

*PC Startup:* To run MiniConfig on a PC, find the AJA MiniConfig in the program list and locate the AJA MiniConfig application.

**Figure 5. PC MiniConfig Startup**

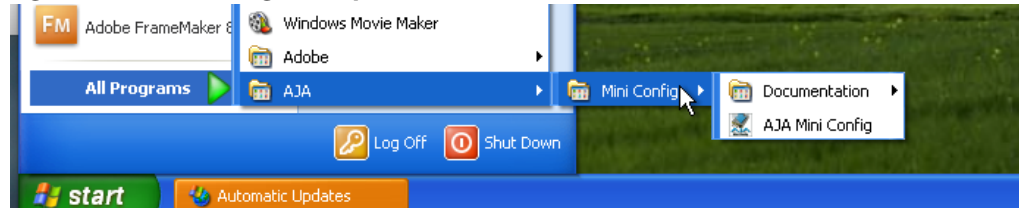

*Mac Startup:* To run MiniConfig on a Mac, double-click the Applications folder and locate the AJA MiniConfig application. Double-click the application to launch it.

*Saving Setups:* A *File* menu at the top of the MiniConfig application menu bar allows you to *Save* the state of the Mini-Converter, with your current settings, to a file for later recall. This allows you to set up the converter for different applications, storing each (with *Save*) to a unique name for easy recall—using the *Open* menu item. A *Revert to Factory Settings* menu item similarly allows you to change the settings back to AJA's factory defaults. An *Edit* menu allows you to cut and paste values to/from fields, just as in other applications.

## Operating MiniConfig

The MiniConfig application provides a graphic interface for viewing settings and updating software. It consists of an information area at the top that shows the available Mini-Converters attached to the computer via USB, with a graphical rendering of the selected Mini-Converter showing all the connectors and their current state.

Colored text next to the connectors indicates the signal type and what the Mini-Converter is doing:

- *Blue* text indicates the values automatically selected
- *Black* text indicates values that you have manually selected
- *Red* text indicates the Mini-Converter is not detecting a signal or cannot negotiate with the attached device

*NOTE:* *Even if no output device is detected, it still shows the signal it is outputting. However, lacking an input signal, the output signal may not be valid.*

*NOTE:* *Configuration settings in red will change based on the attached output device as well as input signals. For improved accuracy and reliability, you should configure the Mini-Converter only when the target output device is attached and input signals are supplied at the inputs.*

Screens are virtually the same on both PC and Mac, with subtle differences that reflect the general look of the platform environment.

*Running Multiple Mini-Converters:* MiniConfig can manage multiple AJA Mini-Converters connected via USB—even when they are of differing types. However it only connects to one at a time. You can choose which Mini-Converter you wish to control using the pulldown menu in the upper right hand corner. If you want to configure and update multiple Mini-Converters in parallel, you can do it by running multiple instances of the MiniConfig application and have each control a different Mini-Converter.

**Figure 6. MiniConfig Screen**

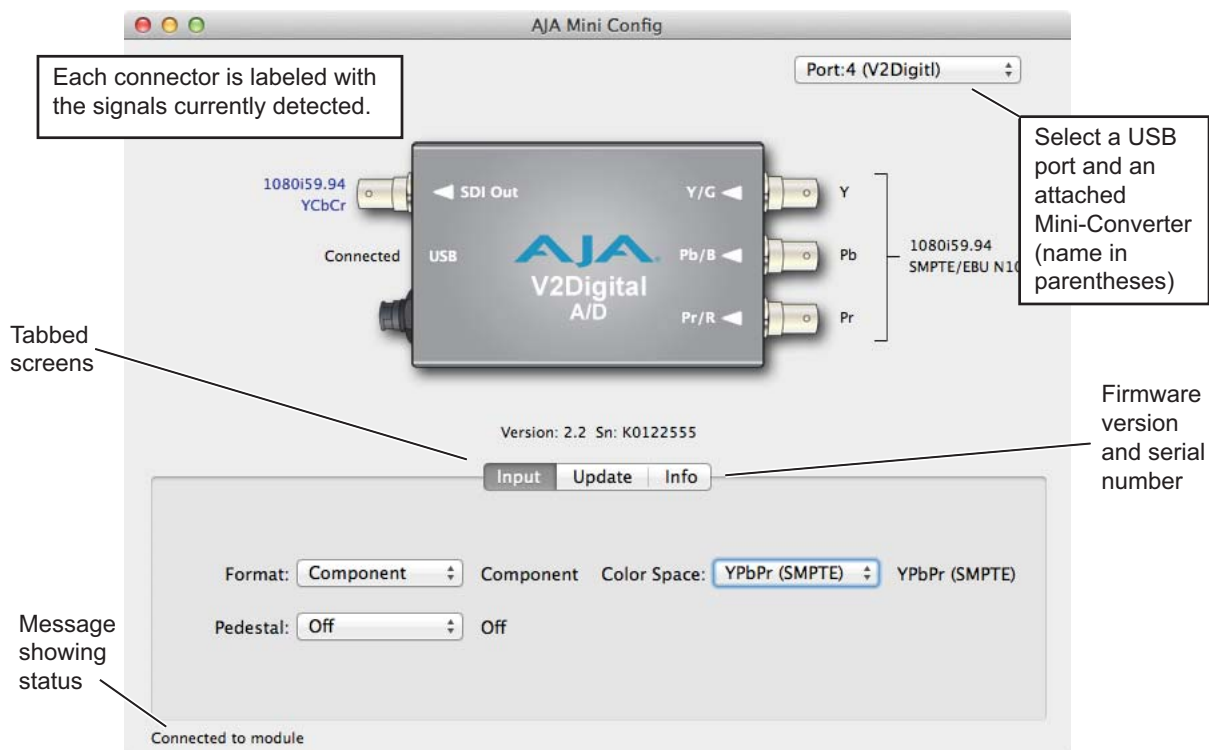

Selecting a Mini-Converter with the dropdown menu causes this application to connect to the selected converter. The graphic of Mini-Converter and text below it provides:

- Type of converter
- Firmware version
- Serial number of the unit

A status field at the bottom of the screen shows if your application is connected and communicating with the Mini-Converter.

When configuring the Mini-Converter, select it from the top pulldown, view the current settings and change any values. Changes are immediately implemented and saved to non-volatile memory, overwriting previous settings.

## Tabbed Screens

The Tabs delineate control screens with groups of controls for each type of task to be performed. The controls for the actual configuration parameters are specific to each Mini-Converter type. Click on any of the tab buttons and the screen below will change to match. Each of these screens are described on the following pages.

## Input Tab Screen

Click on the Input tab to view and make changes to the V2Digital Input settings.

**Figure 7. MiniConfig, Input Tab Screen**

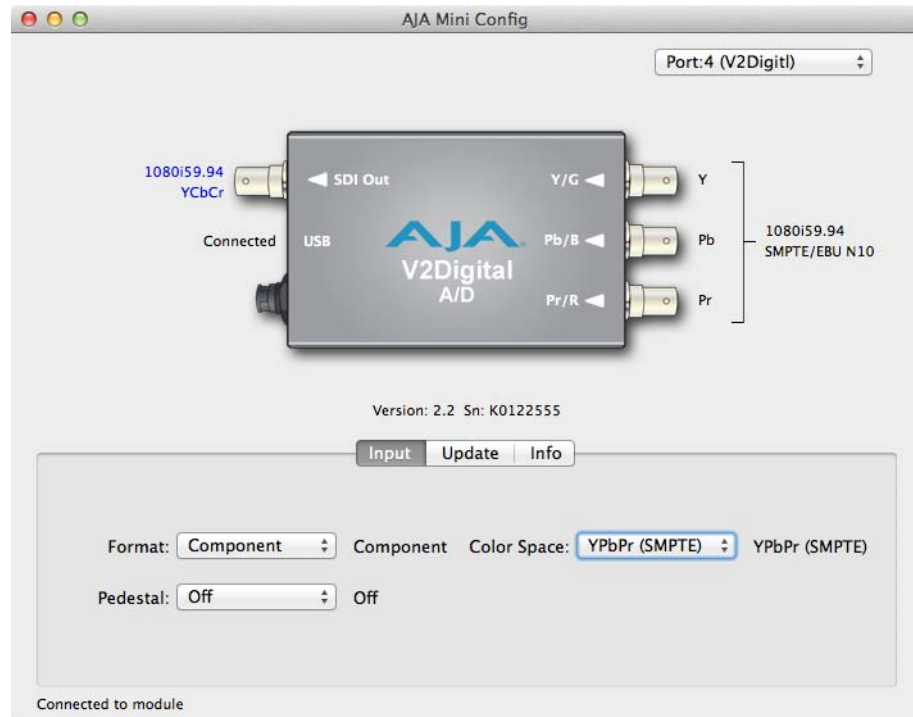

**Format:** Selects the input video format. Only applies if in SD mode. Choose from the following:

- Component
- Composite
- S-Video

**Color Space:** Selects the Input Video Color Space. RGB only applies to HD input video. YPbPr (Betacam) only applies to SD input video. Choose from the following:

- RGB
- YPbPr (SMPTE)
- YPbPr (Betacam)

**Pedestal:** Choose On or Off. Only applies in SD mode. On means the input video has 7.5 IRE pedestal, Off means the input has 0 IRE pedestal.

## Update Tab Screen

Use this Update screen to view the software version currently installed on the converter or install new software.

**Figure 8. MiniConfig, Update Screen**

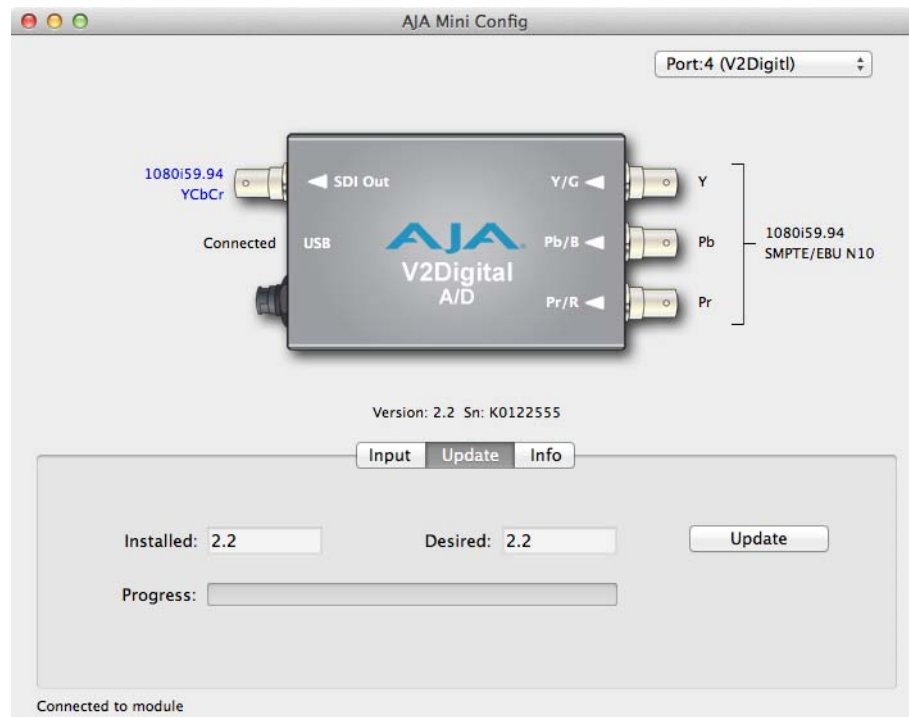

**NOTE:** When discussing Mini-Converters, “Firmware” is software that will be stored in the Mini-Converter’s non-volatile memory and used when it is powered up. This is something different than the MiniConfig application software. The version numbers shown in the Update screen refer only to the firmware.

The following fields and control are present in this screen:

- Installed:** This field shows the version of the firmware currently installed inside the Mini-Converter.
- Desired:** This field shows the version of firmware embedded in the MiniConfig application which you can install into the Mini-Converter by clicking the *Update* button.
- Update:** This button initiates a software update operation loading the “Desired” version of firmware into the Mini-Converter’s non-volatile memory.
- Progress:** This indicator bar shows the progress of software being installed.

### Software Update Procedure

1. Check the AJA website for new MiniConfig software for your Mini-Converter. If new software is found, download it and uncompress the file archive (zip). Here is the URL to use when checking:  
<http://www.aja.com/support/converters/converters-mini-rackmount.php>
2. Connect the Mini-Converter to a Mac or PC via a USB port on the computer and run the new MiniConfig software just downloaded.
3. Click on the Update tab screen.
4. Check the Installed version level against the Desired version level. If the Desired is newer, then click the *Update* button to download the new firmware to the Mini-Converter; progress will be shown via the “Progress” thermometer bar. When you

click Update, MiniConfig will provide a dialog asking you to confirm that you really want to update the firmware (see [Figure 9](#)).

**Figure 9. Firmware Update Confirmation**

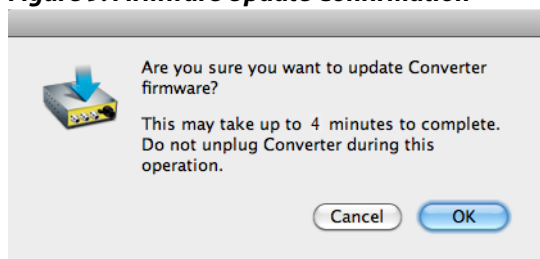

## Info Tab Screen

This screen provides basic information about the Mini-Converter. This information is mostly useful when calling AJA Support for service or technical support.

**Figure 10. MiniConfig, Info Screen**

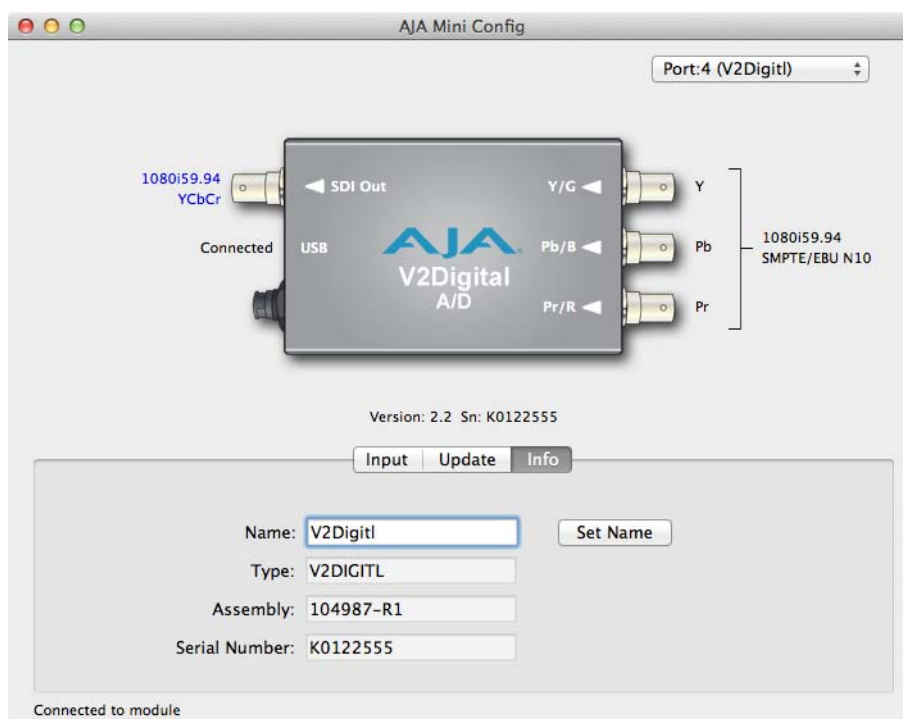

**Name:** This field allows you to give your Mini-Converter a name. This may be useful if you have several Mini-Converters attached to a Mac/PC via USB so you can distinguish one of them easily (especially if they're the same model).

**Type:** This is the factory set model name of the Mini-Converter.

**Assembly:** This is the factory assembly number.

**Serial Number:** This is the factory set unique serial number of your unit. If you ever call AJA Support for service, you may be asked for this number.

## MiniConfig Settings Summary

MiniConfig settings for various input analog formats are shown in [Table 1](#)

**Table 2. Input Analog Formats, DIP Switch Settings, and SDI Output Formats**

Input Standard	Input Analog Format	MiniConfig Controls			Notes
		Format	Color Space	Pedestal	
525i59.94	Composite NTSC	Composite	X	On	
	NTSC S-Video	S-Video	X	On	
	Composite NTSC-J	Composite	X	Off	
	NTSC-J S-Video	S-Video	X	Off	
	Component YPbPr SMPTE/EBU-N10	Component	YPbPr (SMPTE)	X	
	Component YPbPr Betacam	Component	YPbPr (Betacam)	On	
	Component YPbPr Betacam-J	Component	YPbPr (Betacam)	Off	only selectable via MiniConfig
625i50	Composite PAL + S-Video	Composite	X	X	
	PAL S-Video	S-Video	X	X	
	Component YPbPr SMPTE/EBU-N10	Component	X	X	
720p *	Component YPbPr SMPTE/EBU-N10	X	YPbPr (SMPTE)	X	
	Component RGB	X	RGB	X	
1080i/psf *	Component YPbPr SMPTE/EBU-N10	X	YPbPr (SMPTE)	X	
	Component RGB	X	RGB	X	
* = all supported frame rates		Note: X = don't care			



# Appendix A: Specifications

---

## Video Input

---

- HD component YPbPr, RGB (274/296M)
- SD component (Betacam, EBU-N10)/composite/ YC(S-Video)
- 3 x BNC

## Input Formats

- 1080i 25, 29.97, 30 (50, 59.94, 60 fields)
- 1080p/psf 23.98, 24, 25, 29.97, 30
- 720p 50, 59.94, 60
- 525i, 625i

## Video Output

---

- HD/SD-SDI (SMPTE-259/292M), 1 x BNC

## User Controls

---

- Configuration via USB with MiniConfig for Mac or PC
- External DIP switch

## Physical

---

### Power

- +5 to 20V DC regulated, 5 watts max
- AJA external power supply model DWP-U-R1 (included):
  - 100-240V, 50/60Hz universal input

### Size

- 5.1" x 2.4" x 1" (130 x 61 x 25 mm)

### Environment

*Operating Temperature:* 0 to 40 degrees C (32 to 104 degrees F)

*Operating Relative Humidity:* 10-90% non-condensing

*Operating Altitude:* <3,000 meters (<10,000 feet)

*Safe Storage Temperature (Power OFF):* -40 to 60 degrees C (-40 to 140 degrees F)

# Appendix B: Safety and Compliance

---

## Federal Communications Commission (FCC) Compliance Notices

---

### Class B Interference Statement

This equipment has been tested and found to comply with the limits for a Class B digital device, pursuant to Part 15, Subpart B of the FCC Rules. These limits are designed to provide reasonable protection against harmful interference in a residential installation. This equipment generates, uses, and can radiate radio frequency energy and, if not installed and used in accordance with the instructions, may cause harmful interference to radio communications. However, there is no guarantee that interference will not occur in a particular installation. If this equipment does cause harmful interference to radio or television reception, which can be determined by turning the equipment off and on, the user is encouraged to try to correct the interference by one or more of the following measures:

- Reorient or relocate the receiving antenna.
- Increase the separation between the equipment and receiver.
- Connect the equipment into an outlet on a circuit different from that to which the receiver is connected.
- Consult the dealer or an experienced radio/TV technician for help.

### FCC Caution

This device complies with Part 15 of the FCC Rules. Operation is subject to the following two conditions: (1) This device may not cause harmful interference, and (2) this device must accept any interference received, including interference that may cause undesired operation.

## Canadian ICES Statement

---

Canadian Department of Communications Radio Interference Regulations

This digital apparatus does not exceed the Class B limits for radio-noise emissions from a digital apparatus as set out in the Radio Interference Regulations of the Canadian Department of Communications. This Class B digital apparatus complies with Canadian ICES-003.

Règlement sur le brouillage radioélectrique du ministère des Communications

Cet appareil numérique respecte les limites de bruits radioélectriques visant les appareils numériques de classe B prescrites dans le Règlement sur le brouillage radioélectrique du ministère des Communications du Canada. Cet appareil numérique de la Classe B est conforme à la norme NMB-003 du Canada.

# European Union and European Free Trade Association (EFTA) Regulatory Compliance

---

This equipment may be operated in the countries that comprise the member countries of the European Union and the European Free Trade Association. These countries, listed in the following paragraph, are referred to as The European Community throughout this document:

AUSTRIA, BELGIUM, BULGARIA, CYPRUS, CZECH REPUBLIC, DENMARK, ESTONIA, FINLAND, FRANCE, GERMANY, GREECE, HUNGARY, IRELAND, ITALY, LATVIA, LITHUANIA, LUXEMBOURG, MALTA, NETHERLANDS, POLAND, PORTUGAL, ROMANIA, SLOVAKIA, SLOVENIA, SPAIN, SWEDEN, UNITED KINGDOM, ICELAND, LICHTENSTEIN, NORWAY, SWITZERLAND

## Declaration of Conformity

Marking by this symbol indicates compliance with the Essential Requirements of the EMC Directive of the European Union 2004/108/EC.



This equipment meets the following conformance standards:

**Safety** CB- IEC 60065:2001 + A1:2005  
NRTL - UL 60065:2003 R11.06, CSA C22.2 NO. 60065:2003 + A1:06  
GS - EN 60065:2002 + A1

Additional licenses issued for specific countries available on request.

**Emissions** EN 55103-1: 1996  
EN61000-3-2:2006, EN61000-3-3:1995 +A1:2001 +A2:2005

**Immunity** EN 55103-2: 1996  
EN61000-4-2:1995 + A1:1999 + A2:2001, EN61000-4-3:2006, EN61000-4-4:2004,  
EN 61000-4-5: 2005, EN 61000-4-6:2007, EN61000-4-11:2004

The product is also licensed for additional country specific standards as required for the International Marketplace.



### Warning!

This is a Class B product. In a domestic environment, this product may cause radio interference, in which case, the user may be required to take appropriate measures.

Achtung! Dieses ist ein Gerät der Funkstörgrenzwertklasse B. In Wohnbereichen können bei Betrieb dieses Gerätes Rundfunkstörungen auftreten, in welchen Fällen der Benutzer für entsprechende Gegenmaßnahmen verantwortlich ist.

Attention! Ceci est un produit de Classe B. Dans un environnement domestique, ce produit risque de créer des interférences radioélectriques, il appartiendra alors à l'utilisateur de prendre les mesures spécifiques appropriées.

## Korea KCC Compliance Statement

B급 기기 (가정용 방송통신기자재)	이 기기는 가정용(B급) 전자파적합기기로서 주로 가정에서 사용하는 것을 목적으로 하며, 모든 지역에서 사용할 수 있습니다.
Class B (Broadcasting Communication Equipment for Home Use)	As an electromagnetic wave equipment for home use (Class B), this equipment is intended to use mainly for home use and may be used in all areas.

## Taiwan Compliance Statement

This is a Class B product based on the standard of the Bureau of Standards, Metrology and Inspection (BSMI) CNS 13438, Class B.

## Japanese Compliance Statement

### 2. Class B ITE

この装置は、クラスB情報技術装置です。この装置は、家庭環境で使用することを目的としていますが、この装置がラジオやテレビジョン受信機に近接して使用されると、受信障害を引き起こすことがあります。

取扱説明書に従って正しい取り扱いをして下さい。

VCCI-B

This is a Class B product based on the standard of the VCCI Council. If this is used near a radio or television receiver in a domestic environment, it may cause radio interference. Install and use the equipment according to the instruction manual.

## Translated Warning and Caution Messages

The following caution statements, warning conventions, and warning messages apply to this product and manual.





Warning Symbol



Caution Symbol

## Before Operation Please Read These Instructions

	<p><b>Warning!</b> Read and follow all warning notices and instructions marked on the product or included in the documentation.</p> <p><b>Avertissement !</b> Lisez et conformez-vous à tous les avis et instructions d'avertissement indiqués sur le produit ou dans la documentation.</p> <p><b>Warnung!</b> Lesen und befolgen Sie die Warnhinweise und Anweisungen, die auf dem Produkt angebracht oder in der Dokumentation enthalten sind.</p> <p><b>¡Advertencia!</b> Lea y siga todas las instrucciones y advertencias marcadas en el producto o incluidas en la documentación.</p> <p><b>Aviso!</b> Leia e siga todos os avisos e instruções assinalados no produto ou incluídos na documentação.</p> <p><b>Avviso!</b> Leggere e seguire tutti gli avvisi e le istruzioni presenti sul prodotto o inclusi nella documentazione.</p>
---	---

	<p><b>Warning!</b> Do not use this device near water and clean only with a dry cloth.</p> <p><b>Avertissement!</b> N'utilisez pas cet appareil près de l'eau et nettoyez-le seulement avec un tissu sec..</p> <p><b>Warnung!</b> Das Gerät nicht in der Nähe von Wasser verwenden und nur mit einem trockenen Tuch säubern.</p> <p><b>¡Advertencia!</b> No utilice este dispositivo cerca del agua y límpielo solamente con un paño seco.</p> <p><b>Aviso!</b> Não utilize este dispositivo perto da água e limpe-o somente com um pano seco.</p> <p><b>Avviso!</b> Non utilizzare questo dispositivo vicino all'acqua e pulirlo soltanto con un panno asciutto.</p>
---	--

	<p><b>Warning!</b> Do not block any ventilation openings. Install in accordance with the manufacturer's instructions.</p> <p><b>Avertissement !</b> Ne bloquez aucune ouverture de ventilation. Suivez les instructions du fabricant lors de l'installation.</p> <p><b>Warnung!</b> Die Lüftungsöffnungen dürfen nicht blockiert werden. Nur gemäß den Anweisungen des Herstellers installieren.</p> <p><b>¡Advertencia!</b> No bloquee ninguna de las aberturas de la ventilación. Instale de acuerdo con las instrucciones del fabricante.</p> <p><b>Aviso!</b> Não obstrua nenhuma das aberturas de ventilação. Instale de acordo com as instruções do fabricante.</p> <p><b>Avviso!</b> Non ostruire le aperture di ventilazione. Installare in conformità con le istruzioni del fornitore.</p>
---	---

**Warning!**

Do not install near any heat sources such as radiators, heat registers, stoves, or other apparatus (including amplifiers) that produce heat.

**Avertissement !** N'installez pas l'appareil près d'une source de chaleur telle que des radiateurs, des bouches d'air de chauffage, des fourneaux ou d'autres appareils (amplificateurs compris) qui produisent de la chaleur.

**Warnung!** Nicht in der Nähe von Wärmequellen wie Heizkörpern, Heizregistern, Öfen oder anderen Wärme erzeugenden Geräten (einschließlich Verstärkern) aufstellen.

**¡Advertencia!** No instale cerca de fuentes de calor tales como radiadores, registros de calor, estufas u otros aparatos (incluidos amplificadores) que generan calor.

**Aviso!** Não instale perto de nenhuma fonte de calor tal como radiadores, saídas de calor, fogões ou outros aparelhos (incluindo amplificadores) que produzam calor.

**Avviso!** Non installare vicino a fonti di calore come termosifoni, diffusori di aria calda, stufe o altri apparecchi (amplificatori compresi) che emettono calore.

**Warning!**

Do not defeat the safety purpose of the polarized or grounding-type plug. A polarized plug has two blades with one wider than the other. A grounding type plug has two blades and a third grounding prong. The wide blade or the third prong are provided for your safety. If the provided plug does not fit into your outlet, consult an electrician for replacement of the obsolete outlet.

**Avertissement!** La sécurité de la prise polarisée ou de la prise de type mise à la terre ne doit en aucun cas être empêchée de fonctionner. Une prise polarisée a deux broches, l'une étant plus large que l'autre. Une prise de type mise à la terre a deux broches et une troisième broche pour la mise à la terre. La broche large ou la troisième broche sont fournies pour votre sécurité. Si la prise fournie ne s'insère pas dans votre prise femelle, consultez un électricien pour le remplacement de la prise femelle obsolète.

**Warnung!** Der Sicherheitszweck des gepolten bzw. Schukosteckers ist zu berücksichtigen. Ein gepolter Stecker verfügt über zwei Pole, von denen einer breiter als der andere ist. Ein Schukostecker verfügt neben den zwei Polen noch über einen dritten Pol zur Erdung. Der breite Pol bzw. der Erdungspol dienen der Sicherheit. Wenn der zur Verfügung gestellte Stecker nicht in Ihren Anschluss passt, konsultieren Sie einen Elektriker, um den veralteten Anschluss zu ersetzen.

**¡Advertencia!** No eche por tierra la finalidad del tipo de enchufe polarizado con conexión a tierra. Un enchufe polarizado tiene dos espigas, una más ancha que la otra. Un enchufe con conexión a tierra tiene dos espigas iguales y una tercera espiga que sirve para la conexión a tierra. La espiga ancha, o la tercera espiga, sirven para su seguridad. Si el enchufe suministrado no encaja en el tomacorriente, consulte con un electricista para reemplazar el tomacorriente obsoleto.

**Aviso!** Não anule a finalidade da segurança da ficha polarizada ou do tipo ligação terra. Uma ficha polarizada tem duas lâminas sendo uma mais larga do que a outra. Uma ficha do tipo de ligação à terra tem duas lâminas e um terceiro terminal de ligação à terra. A lâmina larga ou o terceiro terminal são fornecidos para sua segurança. Se a ficha fornecida não couber na sua tomada, consulte um electricista para a substituição da tomada obsoleta.

**Avviso!** Non compromettere la sicurezza della spina polarizzata o con messa a terra. Una spina polarizzata ha due spinotti, di cui uno più largo. Una spina con messa a terra ha due spinotti e un terzo polo per la messa a terra. Lo spinotto largo o il terzo polo sono forniti per motivi di sicurezza. Se la spina fornita non si inserisce nella presa di corrente, contattare un elettricista per la sostituzione della presa obsoleta.

**Warning!**

Since the Mains plug is used as the disconnection for the device, it must remain readily accessible and operable.

**Avertissement!** Puisque la prise principale est utilisée pour débrancher l'appareil, elle doit rester aisément accessible et fonctionnelle.

**Warnung!** Da der Netzstecker als Trennvorrichtung dient, muss er stets zugänglich und funktionsfähig sein.

**¡Advertencia!** Puesto que el enchufe de la red eléctrica se utiliza como dispositivo de desconexión, debe seguir siendo fácilmente accesible y operable.

**Aviso!** Dado que a ficha principal é utilizada como a desconexão para o dispositivo, esta deve manter-se prontamente acessível e funcional.

**Avviso!** Poiché il cavo di alimentazione viene usato come dispositivo di sconnessione, deve rimanere prontamente accessibile e operabile.

**Warning!**

Protect the power cord from being walked on or pinched particularly at plugs, convenience receptacles, and the point where they exit from the device.

**Avertissement!** Protégez le cordon d'alimentation pour que l'on ne marche pas dessus ou qu'on le pince, en particulier au niveau des prises mâles, des réceptacles de convenance, et à l'endroit où il sort de l'appareil.

**Warnung!** Vermeiden Sie, dass auf das Netzkabel getreten oder das Kabel geknickt wird, insbesondere an den Steckern, den Steckdosen und am Kabelausgang am Gerät.

**¡Advertencia!** Proteja el cable de energía para que no se le pise ni apriete, en especial cerca del enchufe, los receptáculos de conveniencia y el punto del que salen del equipo.

**Aviso!** Proteja o cabo de alimentação de ser pisado ou de ser comprimido particularmente nas fichas, em tomadas de parede de conveniência e no ponto de onde sai do dispositivo.

**Avviso!** Proteggere il cavo di alimentazione in modo che nessuno ci cammini sopra e che non venga schiacciato soprattutto in corrispondenza delle spine e del punto in cui esce dal dispositivo.



**Warning!**

Unplug this device during lightning storms or when unused for long periods of time.

**Avertissement!** Débranchez cet appareil pendant les orages avec éclairs ou s'il est inutilisé pendant de longues périodes.

**Warnung!** Das Gerät ist bei Gewitterstürmen oder wenn es über lange Zeiträume ungenutzt bleibt vom Netz zu trennen.

**¡Advertencia!** Desenchufe este dispositivo durante tormentas eléctricas o cuando no se lo utilice por largos periodos del tiempo.

**Aviso!** Desconecte este dispositivo da tomada durante trovoadas ou quando não é utilizado durante longos períodos de tempo.

**Avviso!** Utilizzare soltanto i collegamenti e gli accessori specificati e/o venduti dal produttore, quali il treppiedi e l'esoscheletro.

**Warning!**

Refer all servicing to qualified service personnel. Servicing is required when the device has been damaged in any way, such as power-supply cord or plug is damaged, liquid has been spilled or objects have fallen into the device, the device has been exposed to rain or moisture, does not operate normally, or has been dropped.

**Avertissement !** Référez-vous au personnel de service qualifié pour tout entretien. L'entretien est exigé quand l'appareil a été endommagé de quelque manière que ce soit, par exemple lorsque le cordon d'alimentation ou la prise sont endommagés, que du liquide a été versé ou des objets sont tombés dans l'appareil, que l'appareil a été exposé à la pluie ou à l'humidité, ne fonctionne pas normalement ou est tombé.

**Warnung!** Das Gerät sollte nur von qualifizierten Fachkräften gewartet werden. Eine Wartung ist fällig, wenn das Gerät in irgendeiner Weise beschädigt wurde, wie bei beschädigtem Netzkabel oder Netzstecker, falls Flüssigkeiten oder Objekte in das Gerät gelangen, das Gerät Regen oder Feuchtigkeit ausgesetzt wurde, nicht ordnungsgemäß funktioniert oder fallen gelassen wurde.

**¡Advertencia!** Consulte al personal calificado por cuestiones de reparación. El servicio de reparación se requiere cuando el dispositivo ha recibido cualquier tipo de daño, por ejemplo cable o espigas dañadas, se ha derramado líquido o se han caído objetos dentro del dispositivo, el dispositivo ha sido expuesto a la lluvia o humedad, o no funciona de modo normal, o se ha caído.

**Aviso!** Remeta todos os serviços de manutenção para o pessoal de assistência qualificado. A prestação de serviços de manutenção é exigida quando o dispositivo foi danificado mediante qualquer forma, como um cabo de alimentação ou ficha que se encontra danificado/a, quando foi derramado líquido ou caíram objectos sobre o dispositivo, quando o dispositivo foi exposto à chuva ou à humidade, quando não funciona normalmente ou quando foi deixado cair.

**Avviso!** Fare riferimento al personale qualificato per tutti gli interventi di assistenza. L'assistenza è necessaria quando il dispositivo è stato danneggiato in qualche modo, ad esempio se il cavo di alimentazione o la spina sono danneggiati, è stato rovesciato del liquido è stato rovesciato o qualche oggetto è caduto nel dispositivo, il dispositivo è stato esposto a pioggia o umidità, non funziona correttamente o è caduto.

**Warning!**

This device is a Class B product. Operation of this equipment in a residential area is likely to cause harmful interference, in which case users will be required to take whatever measures may be necessary to correct the interference at their own expense.

**Attention!** Le périphérique est un produit de Classe B. Le fonctionnement de cet équipement dans une zone résidentielle risque de causer des interférences nuisibles, auquel cas l'utilisateur devra y remédier à ses propres frais.

**Achtung!** Dies ist ein Gerät der Klasse B. Bei Einsatz des Geräts in Wohngebieten kann es Störungen des Radio- und Fernsehempfangs verursachen. In diesem Fall muss der Benutzer alle notwendigen Maßnahmen ergreifen, die möglicherweise nötig sind, um die Störungen auf eigene Rechnung zu beheben.

**¡Precaución!** Este es un producto clase B. El uso de este equipo en áreas residenciales puede causar interferencias nocivas, en cuyo caso, se requerirá que los usuarios tomen cualquier medida necesaria para corregir la interferencia por cuenta propia.

**Cuidado!** Este dispositivo é um produto Classe B. Operar este equipamento em uma área residencial provavelmente causará interferência prejudicial; neste caso, espera-se que os usuários tomem as medidas necessárias para corrigir a interferência por sua própria conta.

**Attenzione!** Questo dispositivo è un prodotto di Classe B. Il funzionamento di questo apparecchio in aree residenziali potrebbe causare interferenze dannose, nel cui caso agli utenti verrà richiesto di adottare tutte le misure necessarie per porre rimedio alle interferenze a proprie spese.

**Warning!**

Do not open the chassis. There are no user-serviceable parts inside. Opening the chassis will void the warranty unless performed by an AJA service center or licensed facility.

**Avertissement!** Ne pas ouvrir le châssis. Aucun élément à l'intérieur du châssis ne peut être réparé par l'utilisateur. La garantie sera annulée si le châssis est ouvert par toute autre personne qu'un technicien d'un centre de service ou d'un établissement agréé AJA.

**Warnung!** Öffnen Sie das Gehäuse nicht. Keine der Geräteteile können vom Benutzer gewartet werden. Durch das Öffnen des Gehäuses wird die Garantie hinfällig, es sei denn, solche Wartungsarbeiten werden in einem AJA-Service-Center oder einem lizenzierten Betrieb vorgenommen.

**¡Advertencia!** No abra el chasis. El interior no contiene piezas reparables por el usuario. El abrir el chasis anulará la garantía a menos que se lo haga en un centro de servicio AJA o en un local autorizado.

**Advertência!** Não abra o chassi. Não há internamente nenhuma peça que permita manutenção pelo usuário. Abrir o chassi anula a garantia, a menos que a abertura seja realizada por uma central de serviços da AJA ou por um local autorizado.

**Avvertenza!** Non aprire lo chassis. All'interno non ci sono parti riparabili dall'utente. L'apertura dello chassis invaliderà la garanzia se non viene effettuata da un centro ufficiale o autorizzato AJA.

**Warning!**

Disconnect the external AC power supply line cord(s) from the mains power before moving the unit.

**Avertissement!** Retirez le ou les cordons d'alimentation en CA de la source d'alimentation principale lorsque vous déplacez l'appareil.

**Warnung!** Trennen Sie die Wechselstrom-Versorgungskabel vom Netzstrom, bevor Sie das Gerät verschieben.

**¡Advertencia!** Cuando mueva la unidad desenchufe de la red eléctrica el/los cable(s) de la fuente de alimentación CA tipo brick.

**Advertência!** Remova os cabos CA de alimentação brick da rede elétrica ao mover a unidade.

**Avvertenza!** Scollegare il cavo dell'alimentatore quando si sposta l'unità.

# Warranty Information

---

## Limited Warranty

---

AJA Video Systems, Inc. (AJA Video) warrants that this product will be free from defects in materials and workmanship for a period of five years from the date of purchase. If a product proves to be defective during this warranty period, AJA Video, at its option, will either repair the defective product without charge for parts and labor, or will provide a replacement in exchange for the defective product.

In order to obtain service under this warranty, you the Customer, must notify AJA Video of the defect before the expiration of the warranty period and make suitable arrangements for the performance of service. The Customer shall be responsible for packaging and shipping the defective product to a designated service center nominated by AJA Video, with shipping charges prepaid. AJA Video shall pay for the return of the product to the Customer if the shipment is to a location within the country in which the AJA Video service center is located. Customer shall be responsible for paying all shipping charges, insurance, duties, taxes, and any other charges for products returned to any other locations.

This warranty shall not apply to any defect, failure or damage caused by improper use or improper or inadequate maintenance and care. AJA Video shall not be obligated to furnish service under this warranty a) to repair damage resulting from attempts by personnel other than AJA Video representatives to install, repair or service the product, b) to repair damage resulting from improper use or connection to incompatible equipment, c) to repair any damage or malfunction caused by the use of non-AJA Video parts or supplies, or d) to service a product that has been modified or integrated with other products when the effect of such a modification or integration increases the time or difficulty of servicing the product.

THIS WARRANTY IS GIVEN BY AJA VIDEO IN LIEU OF ANY OTHER WARRANTIES, EXPRESS OR IMPLIED. AJA VIDEO AND ITS VENDORS DISCLAIM ANY IMPLIED WARRANTIES OF MERCHANTABILITY OR FITNESS FOR A PARTICULAR PURPOSE. AJA VIDEO'S RESPONSIBILITY TO REPAIR OR REPLACE DEFECTIVE PRODUCTS IS THE WHOLE AND EXCLUSIVE REMEDY PROVIDED TO THE CUSTOMER FOR ANY INDIRECT, SPECIAL, INCIDENTAL OR CONSEQUENTIAL DAMAGES IRRESPECTIVE OF WHETHER AJA VIDEO OR THE VENDOR HAS ADVANCE NOTICE OF THE POSSIBILITY OF SUCH DAMAGES.