

# 9922-2FS • 3G/HD/SD-SDI Dual-Channel Frame Sync with Audio/Video Processing, AES/Analog Audio Embedding/De-Embedding and CVBS I/O

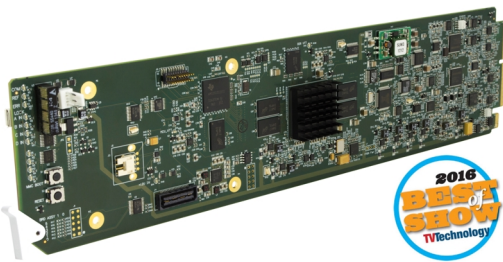

The award-winning Cobalt® 9922-2FS 3G/HD/SD-SDI Dual-Channel Frame Sync with Audio/Video Processing, AES/Analog Audio Embedding/De-Embedding and CVBS I/O offers **two independent signal paths** of frame sync / audio embedding and de-embedding on a single open-Gear® card. Using our HPF-9000 20-slot frame, this provides up to 40 channels of processing in a single frame. The 9922-2FS represents a new level of openGear packaging density!

Advanced frame sync features include per-channel audio delay, audio/video offset, and output rate conversion to and from 23.98/29.97/29.94 to 24/30/60 frame rates. Audio embed adaptive SRC allows asynchronous 48 kHz AES audio to automatically sync with program video 48 kHz timing for glitch-free embedding. Individual, per-pair SRC auto-detects and disables SRC when a Dolby pair is detected on an input pair. Bulk and per-channel audio delay controls easily address lip-sync issues.

Option +TTS provides high-quality Text-To-Speech synthesis, directly converting EAS text to digital audio speech with no baseband signal breakouts or add-ons.

A convenient input crosspoint with RP168 clean switching can select from up to four SDI inputs to be applied to either of the card's two processing paths. The input crosspoint allows manual selection of input via remote control or GPIO, or failover to alternate inputs on loss of input conditions. For each path, two discrete character burn strings can be inserted on output video, with each string inserted as static text and/or insert only upon LOS. With option +T-SLATE, import of user trouble slate graphics is also supported in addition to standard test pattern insert as an input LOS/quality event marker. Moving-box insertion can serve as a dynamic raster confidence check even when the input video image is static. Included standard is closed captioning absence/presence detection for CEA 608/708 and line 21 SD closed captioning.

The space-saving design of the 9922-2FS provides for high density, allowing two cards to be collocated in adjacent slots and served by a single, standard width "split" rear module. This provides four video paths per each pair of slots, readily providing 20 channels of processing in only 10 slots. Two independent paths with fully independent user delays is perfect for setting up path delays for key/fill video. Preset save/load allows saving custom card settings while allowing one-button revert to factory settings. Layered presets allow invoking changes related only to a specific area of concern (audio routing, for example) while not changing any other processing settings or aspects. Full user Dashboard™ or Remote Control Panel remote control allows full status and control access locally or across a standard Ethernet network. GPIO allows direct input routing control and status monitoring.

## FEATURES

Multi-input RP168 clean switch Path inputs can also be sourced from opposite path output with no external patching.

Closed-captioning absence detection

Auto-Changeover can be set to invoke failover for basic input loss.

Moving-box insertion serves as a dynamic raster confidence check even in cases where the input video image is static

Advanced audio processing allows routing, gain, delay, and flexible mixing as standard features

Frame sync with full H/V offset and manual/LOS video pattern generator

Per-path dual independent burn-in text string insertion allows condition-based insertion (such as basic ID text for valid input and different text message for failover conditions)

Timecode processing can prioritize, filter for, and convert between specific SMPTE embedded-video or audio LTC

Option +TTS provides Text-To-Speech synthesis, directly converting EAS text to high-quality digital audio speech with no baseband signal breakouts or add-on units

Full audio crosspoint with delay control and 5.1-to-stereo downmix available for all audio outputs

CVBS analog video I/O and analog/AES embed / de-embed with 4-line Adaptive Comb Filter

Pattern generator for each channel can provide raster/ test pattern and patterns for LOS failover insertion

Low-power/high-density design - less than 18 Watts per card

Remote control/monitoring via Dashboard™ software or OGCP-9000 remote control panels

Five year warranty

## OPTIONS

Quality Check (+QC) - Provides failover, alert, or user presets action on criteria such as black/frozen frame, audio silence, and CC absence.

Text-To-Speech (+TTS) - Provides Text-To-Speech synthesis, directly converting EAS text to digital audio speech with no baseband signal breakouts or add-ons. High-quality Text-To-Speech from Acapela Group.

Emergency Alert System Text Crawl Generation Option (+EAS) - Provides a single-card solution for keying Emergency Alert System (EAS) text crawls in the active video and inserting station identification logos. Compatible with Sage™, Dasdec™, and other EAS crawl generators, with automated control insertion via presence of crawl data or GPI.

Trouble Slate Import (+T-SLATE) - Allows uploading of up to three different user trouble slate graphic file to card, with automated insertion controlled by GPI or other events.

Logo Insertion (+LOGO) - Allows uploading of user logo graphic file to card, with automated insertion controlled by GPI or other events

Clean and Quiet Switching Option (+CQS) - Provides automatic audio muting during switching transitions from one SDI input source to another to provide silence between input switches

SCTE 104 Insertion (+SCTE104) - Provides generation/insertion of SCTE 104 data into baseband SDI. Message send can be triggered from automation GPI or other modes. Full control of splice start, end, and cancel as well as pre-roll offsets.

SCTE104 Frame-Accurate SCTE Trigger Insertion Option (+SCTE104-FAST) - Uses Time Stamp data derived from broadcast automation to provide deterministic, frame-accurate Digital Program Insertion (DPI) message embedding into SDI. The linear channel is output with precise metadata marking the beginning and ending of each program and commercial segment, optimizing it for automatic dissemination to CDN and VOD systems.

Color Correction (+COLOR) - Full RGB color corrector (offset, gain, gamma) with extended YCbCr proc controls with white/black hard clip, white soft clip, and saturation clip

Ancillary Data Processor (+ANC) - Provides full user VANC/HANC packet insertion/extraction access to DID/SDID ancillary data

Expanded Frame Sync Delay (+DLY) - Increases frame buffer to provide adjustable audio/video delay buffer capacity to over 9 seconds for SD video, 1.5 seconds for HD video, or 0.8 seconds for 3G video. Installation: Hardware feature available only on new card.

Key/Fill Keyer (+KEYER)

Audio LTC I/O (+LTC)



## 9922-2FS • 3G/HD/SD-SDI Dual-Channel Frame Sync with Audio/Video Processing, AES/Analog Audio Embedding/De-Embedding and CVBS I/O

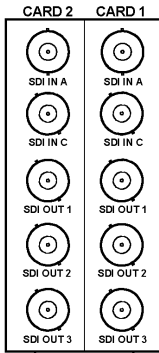
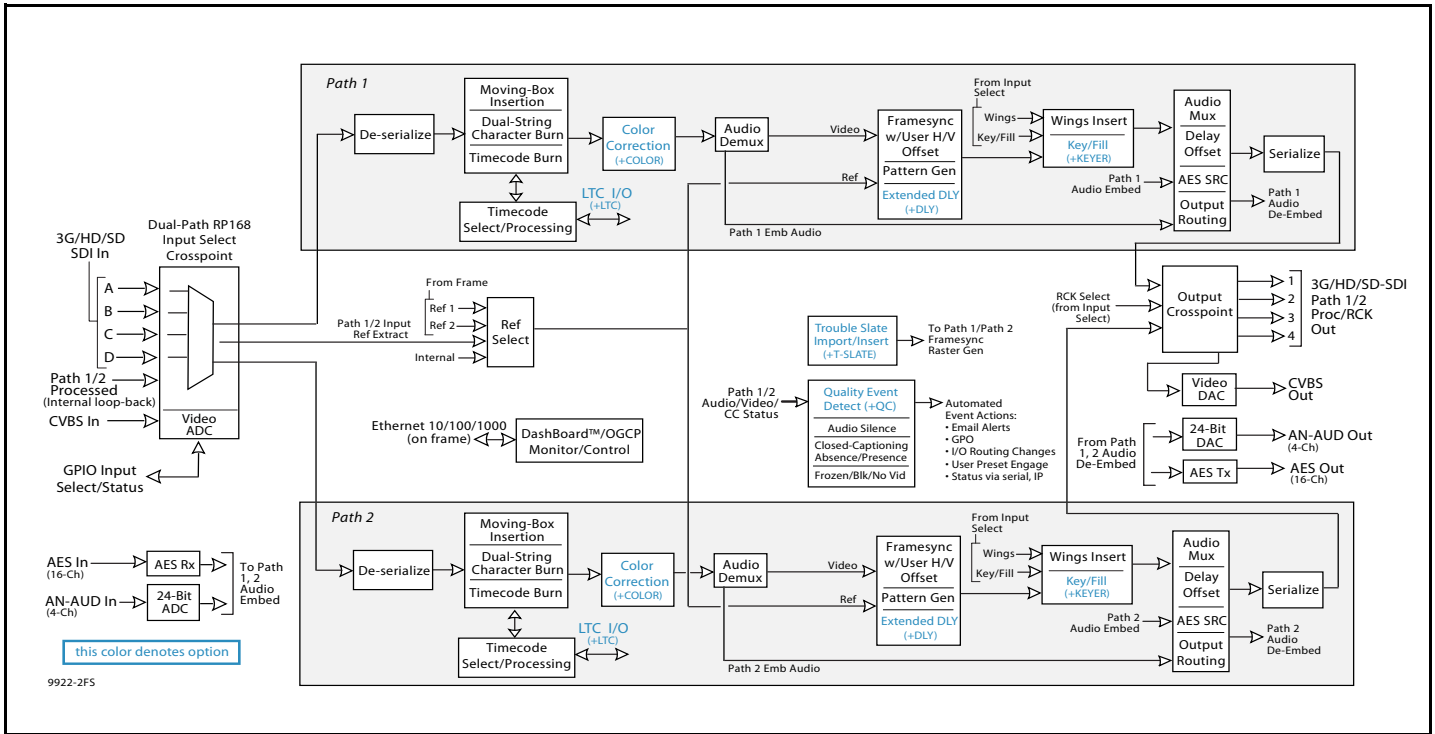

RM20-9922-2FS-AIS

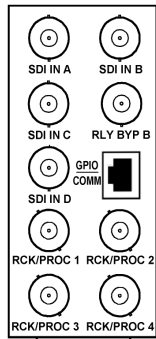

RM20-9922-2FS-C

Note: RCK/PROC 1 thru RCK/PROC 4 are DA outputs which can be individually set as relocked or processed outputs of the currently-selected input.

RLY BYP B is a relay-protected path which carries processed SDI out under normal conditions and passive routes SDI IN B to this BNC upon loss of power.

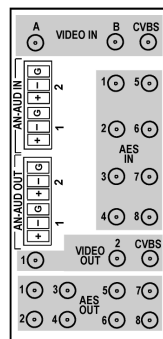

RM20-9922-2FS-D (DIN | HDBNC)

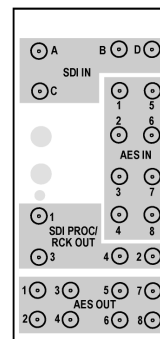

RM20-9922-2FS-E (DIN HDBNC)

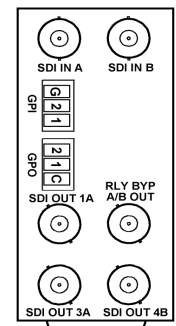

RM20-9922-2FS-F

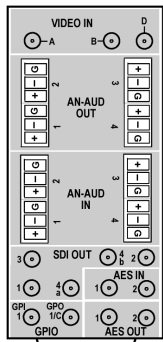

RM20-9922-2FS-H (DIN | HDBNC)

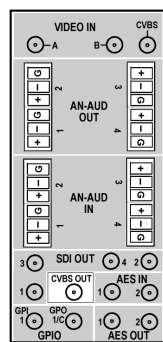

RM20-9922-2FS-J (DIN | HDBNC)

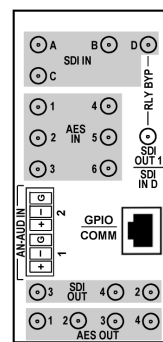

RM20-9922-2FS-K (DIN | HDBNC)

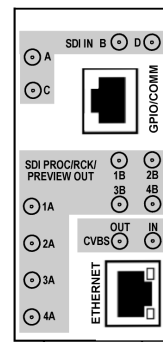

RM20-9922-2FS-L (DIN | HDBNC)

8 - GND  
7 - COM\_A\_RX  
6 - COM\_A\_TX  
5 - GPO OUT 2  
4 - GPO OUT 1  
3 - GPO RTN  
2 - GPI IN 2  
1 - GPI IN 1

Note: A and B outputs are DA pairs of corresponding outputs 1 thru 4.

# 9922-2FS • 3G/HD/SD-SDI Dual-Channel Frame Sync with Audio/Video Processing, AES/Analog Audio Embedding/De-Embedding and CVBS I/O

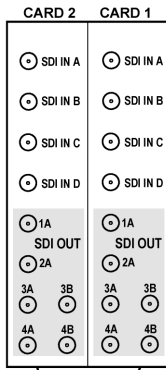

**RM20-9922-2FS-MIS-**  
(DIN | HDBNC)

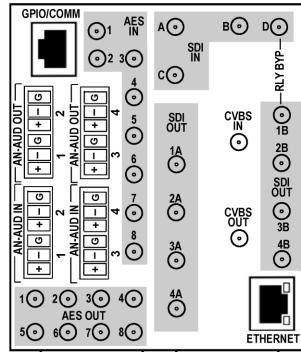

**RM20-9922-2FS-N-**  
(DIN | HDBNC)

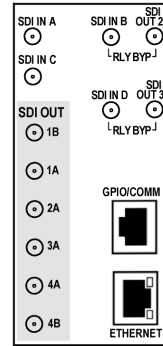

**RM20-9922-2FS-P-**  
(DIN | HDBNC)

- 8 - GND
  - 7 - COM\_A\_RX
  - 6 - COM\_A\_TX
  - 5 - GPO OUT 2
  - 4 - GPO OUT 1
  - 3 - GPO RTN
  - 2 - GPI IN 2
  - 1 - GPI IN 1
- Note: A and B outputs are DA pairs of corresponding outputs 1 thru 4.

## SPECIFICATIONS

Note: Inputs/outputs are a function in some cases of rear I/O module used.

### Power

< 18 Watts

### SDI Input/Outputs

Up to (4) 75Ω BNC inputs  
 Up to (4) 75Ω BNC outputs (selectable as processed SDI Path 1 or Path 2, or selected input reclocked)  
 SDI Formats Supported: SMPTE 259M, SMPTE 292M, SMPTE 424M  
 SDI Receive Cable Length: 3G/HD/SD: 120/180/320 m (Belden 1694A)  
 SDI Return Loss: >15 dB up to 1.485 GHz; >10 dB up to 2.970 GHz  
 SDI Alignment Jitter: 3G/HD/SD: < 0.3/0.2/0.2 UI  
 Timing Jitter: 3G/HD/SD: < 2.0/1.0/0.2 UI  
 Minimum Latency (frame sync disabled): SD: 127 pixels (9.4 us); 720p: 330 pixels (4.45 us); 1080i: 271 pixels (3.65 us); 1080p: 361 pixels (2.43 us)  
 Note: SDI Return loss and receive cable length are affected by rear I/O module used. Specifications represent typical performance.

### CVBS Video Input/Outputs

(1) 75Ω BNC input  
 (1) 75Ω BNC output (selectable as Path 1 or Path 2 processed output). CVBS output functional only when selected path is carrying SD-SDI.  
 ADC resolution: 9-bit  
 Sampling frequency: 27 MHz (2x over-sampling)  
 Y/C separation: 4 line Adaptive Comb Filter  
 Freq. Response: ± 0.25 dB to 5.5 MHz  
 SNR: > 50 dB to 5.5 MHz (unweighted)  
 Differential Phase: < 1 degree  
 Differential Gain: < 1%  
 Nonlinearity < 1%

### Discrete Audio Input/Outputs

AES-3id 75Ω inputs (8 pair (16-Ch) max)  
 AES-3id 75Ω outputs (8 pair (16-Ch) max)  
 Input AES SRC Range: 32 to 96 kHz  
 Balanced analog audio inputs (4-Ch max)  
 Balanced analog audio outputs (4-Ch max)  
 (I/O conforms to 0 dBFS = +24 dBu)  
 Analog Output Impedance: < 50 Ω  
 Analog Reference Level: -20 dBFS  
 Analog Nominal Level: +4 dBu  
 Analog Max Output Level: +24 dBu (0 dBFS)  
 Analog Freq. Response: ±0.2 dB (20 Hz to 20 kHz)  
 Analog SNR: 115 dB (A weighted)  
 Analog Analog THD+N: -96 dB (20 Hz to 10 kHz)  
 Analog Crosstalk: -106 dB (20 Hz to 20 kHz)

# 9922-2FS • 3G/HD/SD-SDI Dual-Channel Frame Sync with Audio/Video Processing, AES/Analog Audio Embedding/De-Embedding and CVBS I/O

## SPECIFICATIONS (cont.)

### Frame Sync Audio/Video Delay

Max offset: 20 frames  
 Latency (min): 1 frame  
 Option +DLY Delay (3G/HD/SD): >800 msec / >1580 msec / >9000 msec

### User Audio Delay Offset from Video

Bulk delay control: -33 msec to +3000 msec.  
 Per-channel delay controls: -800 msec to +800 msec

### Timecode Insertion/Burn-In

Per-path burn-in and embedded video output timecode selected via user controls from input video SMPTE embedded timecode and/or audio LTC. Burn-in enable/disable user controls. Configurable for burn-in string of seconds, seconds:frames, seconds:frames:field. User controls for text size and H/V position.

### Text Burn-In

(2) independent strings per path supported. Independent insertions controls for enable/disable and enable upon LOS. User controls for text size and H/V position.

### GPIO/COMM

(2) GPI configurable to select input routing. (2) GPO configurable to invoke upon input selected. RS-232/485 comm port. All connections via rear module RJ-45 GPIO/COMM jack.

### Frame Reference Input

(2) reference from frame bus or selected program video ref sources. SMPTE 170M/318M "Black Burst", SMPTE 274M/296M "Tri-Level".  
 Return Loss: >35 dB up to 5.75 MHz

## ORDERING INFORMATION

**9922-2FS** 3G/HD/SD-SDI Dual-Channel Frame Sync with Audio/Video Processing, AES/Analog Audio Embedding/De-Embedding and CVBS I/O

**RM20-9922-2FS-A/S** 20-Slot Frame Rear I/O Module (Split; supports 2 cards) (2) 3G/HD/SD-SDI Input BNC, (3) 3G/HD/SD-SDI Processed or Reclocked Output BNCs (connections are per each Card 1 / Card 2 connector bank)

**RM20-9922-2FS-C** 20-Slot Frame Rear I/O Module (Standard Width) (4) 3G/HD/SD-SDI Input BNCs, (4) 3G/HD/SD-SDI Output BNCs, (1) 3G/HD/SDI Output BNC (with relay bypass failover), (1) GPIO/COMM RJ-45 connector

**RM20-9922-2FS-D-DIN** 20-Slot Frame Rear I/O Module (Standard Width) (2) 3G/HD/SD-SDI Inputs, (1) CVBS Input, (8) AES Inputs, (2) Balanced Analog Audio Inputs, (2) 3G/HD/SD-SDI Outputs, (1) CVBS Processed Output, (8) AES Outputs, (2) Balanced Analog Audio Outputs (All coaxial connectors DIN1.0/2.3)

**RM20-9922-2FS-D-HDBNC** 20-Slot Frame Rear I/O Module (Standard Width) (2) 3G/HD/SD-SDI Inputs, (1) CVBS Input, (8) AES Inputs, (2) Balanced Analog Audio Inputs, (2) 3G/HD/SD-SDI Outputs, (1) CVBS Processed Output, (8) AES Outputs, (2) Balanced Analog Audio Outputs (All coaxial connectors HD-BNC)

**RM20-9922-2FS-E-DIN** 20-Slot Frame Rear I/O Module (Standard Width) (4) 3G/HD/SD-SDI Inputs, (8) AES Inputs, (4) 3G/HD/SD-SDI Outputs, (8) AES Outputs (All coaxial connectors DIN1.0/2.3)

**RM20-9922-2FS-E-HDBNC** 20-Slot Frame Rear I/O Module (Standard Width) (4) 3G/HD/SD-SDI Inputs, (8) AES Inputs, (4) 3G/HD/SD-SDI Outputs, (8) AES Outputs (All coaxial connectors HD-BNC)

**RM20-9922-2FS-F** 20-Slot Frame Rear I/O Module (Standard Width) (2) 3G/HD/SD-SDI Input BNCs, (1) 3G/HD/SD-SDI Processed Out BNC w/ Latching Input Select/Bypass, (3) 3G/HD/SD-SDI Output BNCs (GUI-selectable as Processed or Reclocked of selected input, (2) GPI, (2) GPO

**RM20-9922-2FS-H-DIN** 20-Slot Frame Rear I/O Module (Standard Width) (3) 3G/HD/SD-SDI Inputs, (2) AES Inputs, (4) Balanced Analog Audio Inputs, (5) 3G/HD/SD-SDI Outputs, (2) AES Outputs, (4) Balanced Analog Audio Outputs, (1) Coaxial GPI/6 Hz, (1) Coaxial GPO w/ Isolated Return (All coaxial connectors DIN1.0/2.3.)

**RM20-9922-2FS-H-HDBNC** 20-Slot Frame Rear I/O Module (Standard Width) (3) 3G/HD/SD-SDI Inputs, (2) AES Inputs, (4) Balanced Analog Audio Inputs, (5) 3G/HD/SD-SDI Outputs, (2) AES Outputs, (4) Balanced Analog Audio Outputs, (1) Coaxial GPI/6 Hz, (1) Coaxial GPO w/ Isolated Return (All coaxial connectors HD-BNC.)

**RM20-9922-2FS-J-DIN** 20-Slot Frame Rear I/O Module (Standard Width) (2) 3G/HD/SD-SDI Inputs, (1) CVBS Input, (2) AES Inputs, (4) Balanced Analog Audio Inputs, (4) 3G/HD/SD-SDI Outputs, (1) CVBS Output, (2) AES Outputs, (4) Balanced Analog Audio Outputs, (1) Coaxial GPI/6 Hz, (1) Coaxial GPO w/ Isolated Return (All coaxial connectors DIN1.0/2.3.)

**RM20-9922-2FS-J-HDBNC** 20-Slot Frame Rear I/O Module (Standard Width) (2) 3G/HD/SD-SDI Inputs, (1) CVBS Input, (2) AES Inputs, (4) Balanced Analog Audio Inputs, (4) 3G/HD/SD-SDI Outputs, (1) CVBS Output, (2) AES Outputs, (4) Balanced Analog Audio Outputs, (1) Coaxial GPI/6 Hz, (1) Coaxial GPO w/ Isolated Return (All coaxial connectors HD-BNC.)

**RM20-9922-2FS-K-DIN** 20-Slot Frame Rear I/O Module (Standard Width) (4) 3G/HD/SD-SDI Inputs, (4) 3G/HD/SD-SDI Outputs (one 3G/HD/SDI Output with relay bypass failover), (6) AES Inputs, (2) Balanced Analog Audio Inputs, (4) AES Outputs, GPIO/COMM RJ-45 connector (All coaxial connectors DIN1.0/2.3)

**RM20-9922-2FS-K-HDBNC** 20-Slot Frame Rear I/O Module (Standard Width) (4) 3G/HD/SD-SDI Inputs, (4) 3G/HD/SD-SDI Outputs (one 3G/HD/SDI Output with relay bypass failover), (6) AES Inputs, (2) Balanced Analog Audio Inputs, (4) AES Outputs, GPIO/COMM RJ-45 connector (All coaxial connectors HD-BNC)

# 9922-2FS • 3G/HD/SD-SDI Dual-Channel Frame Sync with Audio/Video Processing, AES/Analog Audio Embedding/De-Embedding and CVBS I/O

## ORDERING INFORMATION (cont.)

**RM20-9922-2FS-L-DIN** 20-Slot Frame Rear I/O Module (Standard-Width) (4) 3G/HD/SD-SDI Inputs, (1) CVBS Input, (8) 3G/HD/SD-SDI Outputs (1x2 DA output of each crosspoint out), (1) CVBS Output, COMM/GPIO RJ-45 connector, Ethernet Port (All coaxial connectors DIN1.0/2.3)

**RM20-9922-2FS-L-HDBNC** 20-Slot Frame Rear I/O Module (Standard-Width) (4) 3G/HD/SD-SDI Inputs, (1) CVBS Input, (8) 3G/HD/SD-SDI Outputs (1x2 DA output of each crosspoint out), (1) CVBS Output, COMM/GPIO RJ-45 connector, Ethernet Port (All coaxial connectors HD-BNC)

**RM20-9922-2FS-M/S-DIN** 20-Slot Frame Rear I/O Module (Split; supports 2 cards) (4) 3G/HD/SD-SDI Inputs, (6) 3G/HD/SD-SDI Outputs (Connections are per each Card 1 / Card 2 connector bank; all coaxial connectors DIN1.0/2.3)

**RM20-9922-2FS-M/S-HDBNC** 20-Slot Frame Rear I/O Module (Split; supports 2 cards) (4) 3G/HD/SD-SDI Inputs, (6) 3G/HD/SD-SDI Outputs (Connections are per each Card 1 / Card 2 connector bank; all coaxial connectors HD-BNC)

**RM20-9922-2FS-N-DIN** 20-Slot Frame Rear I/O Module (Double Width) (4) 3G/HD/SD-SDI Inputs, (1) CVBS Analog Video In, (8) AES Inputs, (4) Balanced Analog Audio Inputs, (8) 3G/HD/SD-SDI Outputs (1 with relay bypass protect) , (1) CVBS Analog Video Out, (8) AES Outputs, (4) Balanced Analog Audio Outputs, (1) GPIO/COMM RJ-45 connector, 100/1000 BaseT Ethernet Port (All coaxial connectors DIN1.0/2.3.)

**RM20-9922-2FS-N-HDBNC** 20-Slot Frame Rear I/O Module (Double Width) (4) 3G/HD/SD-SDI Inputs, (1) CVBS Analog Video In, (8) AES Inputs, (4) Balanced Analog Audio Inputs, (8) 3G/HD/SD-SDI Outputs (1 with relay bypass protect) , (1) CVBS Analog Video Out, (8) AES Outputs, (4) Balanced Analog Audio Outputs, (1) GPIO/COMM RJ-45 connector, 100/1000 BaseT Ethernet Port (All coaxial connectors HD-BNC.)

**RM20-9922-2FS-P-DIN** 20-Slot Frame Rear I/O Module (Standard-Width) (4) 3G/HD/SD-SDI Inputs (2 with independent relay bypass), (8) 3G/HD/SD-SDI Outputs (1x2 DA output of each crosspoint out), COMM/GPIO RJ-45 connector, Ethernet Port (All coaxial connectors DIN1.0/2.3)

**RM20-9922-2FS-P-HDBNC** 20-Slot Frame Rear I/O Module (Standard-Width) (4) 3G/HD/SD-SDI Inputs (2 with independent relay bypass), (8) 3G/HD/SD-SDI Outputs (1x2 DA output of each crosspoint out), COMM/GPIO RJ-45 connector, Ethernet Port (All coaxial connectors HD-BNC)

### Options:

+**ANC** Ancillary Data Processor Option

+**COLOR** Color Correction Option

+**DLY** Extended Delay Option

+**KEYER** Key/Fill Keyer Option

+**LTC** Audio LTC I/O Option

+**CQS** Clean and Quiet Switching Option

+**QC** Quality Check Option

+**TTS** Text-To-Speech Option (Acapela Text-To-Speech from Acapela Group™. Installation requires option upload and installation of speech library SD memory card onto host card. Pre-loaded SD card and instructions provided.)

+**2L-SPAN** Add Spanish-language upgrade (add-on to option +TTS; option +TTS required)

+**EAS** Emergency Alert System Text Crawl Generation Option

+**DLY** Extended Frame Sync Delay Option

+**T-SLATE** User Trouble Slate Graphic Import Option

+**LOGO** Logo Insertion Option

+**SCTE104** SCTE 104 Insertion Option

+**SCTE104-FAST** Frame-Accurate SCTE 104 Trigger Insertion Option