

Advantage® Electrol®

Automatic Electric Projection Screen Model



SPECIFICATION DATA

SUGGESTED SPECIFICATIONS: _____ projection screen(s), _____(H) x _____(W), electrically operated 120 volt (60Hz), not more than 2.4 amp with a quick connect male plug-in connector on the motor. Shall have specially designed motor mounted inside the roller, to be three wire with ground, quick reversal type, oiled for life, with automatic thermal overload cutout, integral gears, capacitor and an electric brake to prevent coasting. To have preset but adjustable limit switches to automatically stop picture surface in the "up" and "down" positions. Junction box shall be externally integrated into the housing making it possible to install the housing and wire to the building's electrical system during construction. The junction box shall contain a quick connect connector that is mounted in the housing for easy plug-in connection to the motorized fabric and roller assembly. The roller to be of rigid metal. The motorized fabric and roller assembly to be installed in the case at the factory or at a later time at the job site. Roller mounting brackets to be adjustable to allow centering or offsetting of the screen within the case. Screen

to be designed for left or right-hand motor installation. Screen fabric to be flame retardant and mildew resistant fiberglass with black masking borders standard. Bottom of fabric shall be formed into a pocket holding a metal rod. Heavy duty plastic caps shall protect the ends of the rod. Top, front and back of case to be made of extruded aluminum powder coated white. End caps to be of heavy gauge steel, powder coated white. Bottom of case to have a removable access door. Door to be of extruded aluminum powder coated white. Bottom of case to be self-trimming, with a built-in flange around the bottom of the case. To be complete with integrated low voltage control unit and three position control switch and cover plate. Suitable for use in environmental air space in accordance with section 300-22 (c) of the National Electric Code, and sections 2-128, 12-010 (3) and 12-100 of the Canadian Electrical Code, part 1, CSA C22.1. Screen to be listed by Underwriters' Laboratories.



HDTV (16:9) Format Dimensions (2" standard black drop at top)

Viewing Area (H x W)		Nominal Diagonal		Overall Length of Case*		Approx. Ship. Wt.	
In.	Cm	In.	Cm	In.	Cm	Lbs.	Kg
45" x 80"	114 x 203	92"	234	89½"	227	75	34
52" x 92"	132 x 234	106"	269	101½"	258	88	39.9
54" x 96"	137 x 244	110"	279	105½"	268	89	40.4
58" x 104"	147 x 264	119"	302	113½"	288	95	43.1
65" x 116"	165 x 295	133"	338	125½"	319	98	44.5
78" x 139"	198 x 353	159"	404	149½"	380	104	47.2
90" x 160"	229 x 406	184"	467	169½"	431	123	55.8

Wide (16:10) Format Dimensions (2" standard black drop at top)

Viewing Area (H x W)		Nominal Diagonal		Overall Length of Case*		Approx. Ship. Wt.	
In.	Cm	In.	Cm	In.	Cm	Lbs.	Kg
50" x 80"	127 x 203	94"	239	89½"	227	75	34
57½" x 92"	146 x 234	109"	277	101½"	258	88	39.9
60" x 96"	152 x 244	113"	287	105½"	268	89	40.4
65" x 104"	165 x 204	123"	312	113½"	288	95	43.1
69" x 110"	175 x 279	130"	330	119½"	304	97	44
72½" x 116"	184 x 295	137"	348	125½"	319	100	45
87" x 139"	221 x 353	164"	417	149½"	380	104	47.2
100" x 160"	254 x 406	189"	480	169½"	431	123	55.8

Video (NTSC 4:3) Format Dimensions (2" standard black drop at top)

Viewing Area (H x W)		Nominal Diagonal		Overall Length of Case*		Approx. Ship. Wt.	
In.	Cm	In.	Cm	In.	Cm	Lbs.	Kg
43" x 57"	109 x 145	72"	183	65½"	166	60	27.2
50" x 67"	127 x 170	84"	213	75½"	192	65	29.5
60" x 80"	152 x 203	100"	254	89½"	227	77	34.9
69" x 92"	175 x 234	120"	305	101½"	258	89	40.4
87" x 116"	221 x 295	150"	381	125½"	319	100	45.4
105" x 140"	267 x 356	180"	457	149½"	380	106	48.1
120" x 160"	305 x 406	200"	508	169½"	431	123	55.8

Square Format Dimensions (screens marked ** have 2" standard black drop at top)

Sizes (H x W)		Overall Length of Case*		Approx. Ship. Wt.	
In.	Cm	In.	Cm	Lbs.	Kg
60" x 60"	152 x 152	65½"	166	61	27.7
70" x 70"	178 x 178	75½"	192	68	30.8
84" x 84"	213 x 213	89½"	227	79	35.8
8' x 8'	244 x 244	101½"	258	91	41.3
9' x 9**	274 x 274	113½"	288	97	44
10' x 10**	305 x 305	125½"	319	102	46.3
12' x 12'	366 x 366	149½"	380	119	54

*Case length does not include flange

PRODUCT NOTES

- Overall case length dimensions +/- 1/4" (0.6 cm).
- Detail dimensional drawings, wiring diagrams and installation instructions available upon request.
- Specifications subject to change without notice.
- Custom formats and sizes available upon request.
- Electrical junction box extends 2 1/8" (5.4 cm) past case length on left end of case, 1 1/8" (2.9 cm) past ceiling flange.
- Internal junction box available. Will add 3 1/2" (8.9 cm) to overall case length and must be specified at time of order, recommended for drywall installations.
- Junction box on top of case available. Will add 3 1/2" (8.9 cm) to overall case length and 1 7/8" (4.8 cm) to height at left end of case; must be specified at time of order.

SURFACE INFORMATION

Matte White: Horizontal seam required when both dimensions exceed 10'.

High Contrast Matte White & Video Spectra 1.5: Available in sizes where both dimensions do not exceed 8'.

WHEN ORDERING, MARK APPROPRIATE SELECTIONS

- Select size from charts.
- Select viewing surface (All Da-Lite surfaces are GREENGUARD GOLD Certified):
 - Matte White
 - High Contrast Matte White
 - Video Spectra 1.5
- Options:
 - Extra Drop available to lower picture area more than normal. Specify total drop at top ___ (black or white) or at bottom ___ (black or white). 13' maximum total surface height including picture area.
 - No Borders (Black masking borders standard).
 - Internal Junction Box (see product notes)
 - Junction Box on Top of Case (see product notes)
 - 220 Volt (50 Hz) Motor.
 - Video Projector Interface Control - built-in (Adds 10" to case length on 220V motor only).
 - SCB-100 RS-232 Serial Control Board - built-in. (adds 10" to overall length of case)
 - NET-100 Ethernet-Serial Adapter
 - SCB-200 RS-232 Serial Control Board - built-in only. (adds 10" to overall length of case)
 - WC-200 Wall Controller
 - IR-200 Infrared Remote
- Optional Accessories:
 - Wireless Remote Control for LVC.
 - Radio Frequency Remote.
 - Radio Frequency Range Extender available
 - Infrared Remote.
 - Key Locking Cover Plate for LVC Switch.

SUGGESTED METHODS OF INSTALLATION

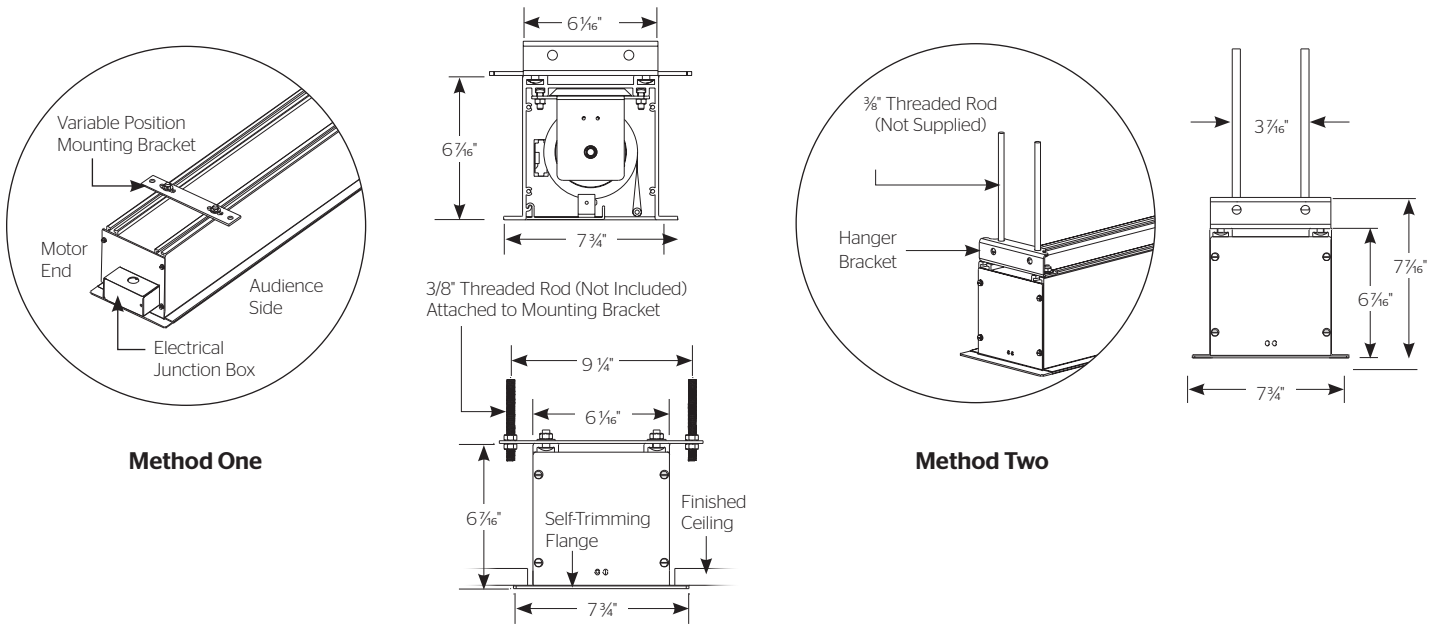

FOR YOUR IMAGE | legrandav.com

USA P 866.977.3901 E info@da-lite.com
 CANADA P 877.345.4329 E canadainfo@milestone.com
 EMEA P +31 495 580 840 E emea.sales@milestone.com
 APAC P +852 2145 4099 E asia.da-lite@milestone.com

In British Columbia, Milestone AV Technologies ULC carries on business as MAVT Milestone AV Technologies ULC.

©2018 Milestone AV Technologies, DL-0148 (Rev. 9) 8/18 Da-Lite is a registered trademark of Milestone AV Technologies. All other brand names or marks are used for identification purposes and are trademarks of their respective owners. All patents are protected under existing designations. Other patents pending.

Project Name: _____

Architect: _____

Contractor: _____ Phone: _____

Reseller: _____ Phone: _____