

Model B®

Spring Roller-Type Screen



SPECIFICATION DATA

SUGGESTED SPECIFICATIONS: _____ projection screen(s), _____(H) x _____(W), wall or ceiling mounting type. Screen to have a powder coated white 22-gauge octagonal steel case with flat back design and fitted with end caps concealing roller ends with integral bearing surface to support roller and integral brackets for wall mounting by means of slotted screw holes and ceiling mounting by means of powder coated hanger rings. Bottom of fabric shall be mounted securely into a powder coated tubular

steel slat. Ends of slat shall be protected by plastic caps. A steel pull bail shall be attached to slat. A 36" (91 cm) pull cord with plastic knob is included. To have masking borders standard on flame retardant and mildew resistant fiberglass fabric. Fabric shall be mounted into a metal strip in a metal Camlok® roller system without tape, glue, staples or cords so that fabric may be easily replaced yet cannot be pulled from roller.

HDTV (16:9) Format Dimensions

| Viewing Area (H x W) | | Nominal Diagonal | | A - Overall Length of Case | | B - Between Hanger Eyes | | C - Brackets | | D - Case Diameter (Width) | | Approx. Ship. Wt. | |
|----------------------|-----------|------------------|-----|----------------------------|-----|-------------------------|-----|--------------|-----|---------------------------|----|-------------------|------|
| In. | Cm | In. | Cm | In. | Cm | In. | Cm | In. | Cm | In. | Cm | Lbs. | Kg |
| 37½" x 67" | 95 x 170 | 77" | 196 | 73%" | 186 | 72%" | 184 | 3%" | 8.6 | 2½" | 6 | 15 | 6.8 |
| 45" x 80" | 114 x 203 | 92" | 234 | 87%" | 222 | 86%" | 220 | 3%" | 9.2 | 2¾" | 7 | 23 | 10.4 |
| 52" x 92" | 132 x 234 | 106" | 269 | 99%" | 252 | 98%" | 251 | 3%" | 9.2 | 2¾" | 7 | 26 | 11.8 |

(16:10) Wide Format Dimensions

| Viewing Area (H x W) | | Nominal Diagonal | | A - Overall Length of Case | | B - Between Hanger Eyes | | C - Brackets | | D - Case Diameter (Width) | | Approx. Ship. Wt. | |
|----------------------|-----------|------------------|-----|----------------------------|-----|-------------------------|-----|--------------|-----|---------------------------|----|-------------------|------|
| In. | Cm | In. | Cm | In. | Cm | In. | Cm | In. | Cm | In. | Cm | Lbs. | Kg |
| 50" x 80" | 127 x 203 | 94" | 239 | 87%" | 222 | 86%" | 220 | 3%" | 9.2 | 2¾" | 7 | 24 | 10.9 |
| 57½" x 92" | 146 x 234 | 109" | 277 | 99%" | 252 | 98%" | 251 | 3%" | 9.2 | 2¾" | 7 | 27 | 12.3 |

Video (NTSC 4:3) Format Dimensions

| Viewing Area (H x W) | | Nominal Diagonal | | A - Overall Length of Case | | B - Between Hanger Eyes | | C - Brackets | | D - Case Diameter (Width) | | Approx. Ship. Wt. | |
|----------------------|-----------|------------------|-----|----------------------------|-----|-------------------------|-----|--------------|-----|---------------------------|----|-------------------|------|
| In. | Cm | In. | Cm | In. | Cm | In. | Cm | In. | Cm | In. | Cm | Lbs. | Kg |
| 43" x 57" | 109 x 145 | 72" | 183 | 63%" | 161 | 62%" | 159 | 3%" | 8.6 | 2½" | 6 | 13 | 5.9 |
| 50" x 67" | 127 x 170 | 84" | 213 | 73%" | 186 | 72%" | 184 | 3%" | 8.6 | 2½" | 6 | 15 | 6.8 |
| 60" x 80" | 152 x 203 | 100" | 254 | 87%" | 222 | 86%" | 220 | 3%" | 9.2 | 2¾" | 7 | 24 | 10.9 |
| 69" x 92" | 175 x 234 | 120" | 305 | 99%" | 252 | 98%" | 251 | 3%" | 9.2 | 2¾" | 7 | 27 | 12.3 |

Square Format Dimensions

| Sizes (H x W) | | A - Overall Length of Case | | B - Between Hanger Eyes | | C - Brackets | | D - Case Diameter (Width) | | Approx. Ship. Wt. | |
|---------------|-----------|----------------------------|-----|-------------------------|-----|--------------|-----|---------------------------|----|-------------------|------|
| In. | Cm | In. | Cm | In. | Cm | In. | Cm | In. | Cm | Lbs. | Kg |
| 40" x 40" | 102 x 102 | 43%" | 110 | 42%" | 108 | 3%" | 8.6 | 2½" | 6 | 9 | 4.1 |
| 50" x 50" | 127 x 127 | 53%" | 136 | 52%" | 134 | 3%" | 8.6 | 2½" | 6 | 12 | 5.4 |
| 60" x 60" | 152 x 152 | 63%" | 161 | 62%" | 159 | 3%" | 8.6 | 2½" | 6 | 14 | 6.4 |
| 70" x 70" | 178 x 178 | 73%" | 186 | 72%" | 184 | 3%" | 8.6 | 2½" | 6 | 17 | 7.7 |
| 72" x 72" | 183 x 183 | 75%" | 191 | 74%" | 190 | 3%" | 9.2 | 2¾" | 7 | 19 | 8.6 |
| 84" x 84" | 213 x 213 | 87%" | 222 | 86%" | 220 | 3%" | 9.2 | 2¾" | 7 | 26 | 11.8 |
| 96" x 96" | 244 x 244 | 99%" | 252 | 98%" | 251 | 3%" | 9.2 | 2¾" | 7 | 30 | 13.6 |

PRODUCT NOTES

- **Matte White, Video Spectra 1.5 and High Contrast Matte White:** Surfaces will be seamless in standard sizes.
- Overall case length dimensions +/- 1/4" (6 mm).
- Specifications subject to change without notice.
- Hanger rings add 3/4" (19 mm) to the overall dimension C.
- Custom formats and sizes available upon request.
- **Optional Accessories:** to provide clearance: Furnish 6" (15 cm) heavy extension wall brackets to mount screen. To provide for keystone elimination: Furnish #11 or #23 adjustable extension wall brackets. Furnish magnetic tilt lock for keystone elimination.
- **NOTE:** Brackets also are used for mounting screen across a corner.

WHEN ORDERING, MARK APPROPRIATE SELECTIONS:

1. Select size from charts on the other side.
2. Select viewing surface (All Da-Lite surfaces are GREENGUARD GOLD Certified):
 - Matte White
 - Video Spectra 1.5
 - High Contrast Matte White
3. Optional accessories:
 - No. 6 Wall Bracket - 6" (15 cm) non-adjustable extension brackets (140#, 63.5 kg, per pair maximum) (black or white).
 - Tilt-Lock for Keystone Elimination (used with extension brackets).
 - No. 11 Wall Bracket - 10" or 14" (25 or 36 cm) non-adjustable extension brackets (75#, 34 kg, per pair maximum) (black or white).
 - T-Bar Clip for drop ceilings (50#, 23.7 kg, per pair maximum) (black or white).
 - No. 23 Adjustable Wall Bracket - 10", 14", 15 3/4", 18 3/4", 20" or 24" (25, 36, 40, 46, 51 or 61 cm) adjustable extension brackets (75#, 34 kg, per pair maximum) (black or white).
 - Pull Rod - 38" (97 cm).
 - No borders (Black masking borders standard).
 - Black case (white standard).

PRODUCT VIEWS

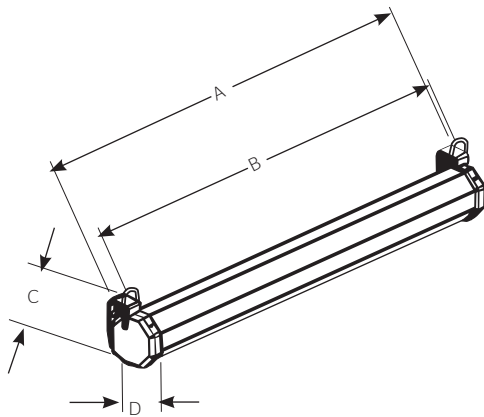

ACCESSORIES

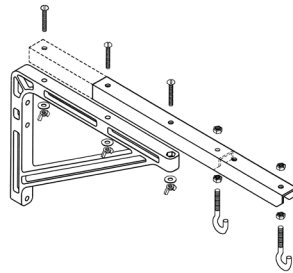

No. 23 Adjustable Wall Bracket
Screen can be extended 10", 14", 15 3/4", 18 3/4", 20" or 24" from wall by wing nut and bolt adjustment.

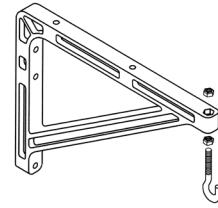

No. 11 Wall Bracket
Screen can be extended 10" or 14" from wall by changing position of bracket.

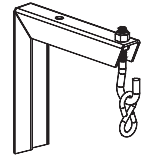

No. 6 Wall Bracket
Screen can be extended 6" from wall.

Extension Wall Brackets

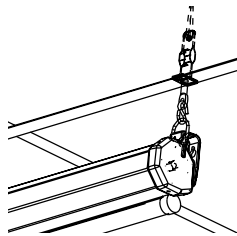

T-Bar Clip for drop ceiling, 50 lb. capacity.

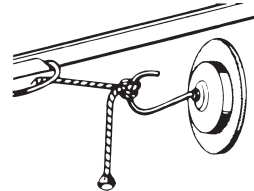

Tilt Lock for Keystone elimination. Used with extension brackets.

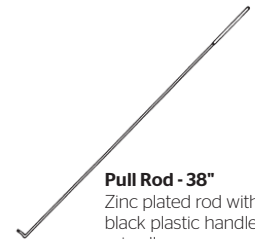

Pull Rod - 38"
Zinc plated rod with black plastic handle grip allows easy access to screen when mounted out of reach. Also can be used as a pointer.



A BRAND OF MILESTONE AV TECHNOLOGIES

www.milestone.com
 P 800.622.3737 / 574.267.8101
 F 877.325.4832 / 574.267.7804
 E info@da-lite.com

In British Columbia, Milestone AV Technologies ULC carries on business as MAVT Milestone AV Technologies ULC.

©2017 Milestone AV Technologies. DL-0224 (Rev. 1) 0617.
 Da-Lite is a registered trademarks of Milestone AV Technologies. All other brand names or marks are used for identification purposes and are trademarks of their respective owners. All patents are protected under existing designations. Other patents pending.

Project Name: _____
 Architect: _____
 Contractor: _____ Phone: _____
 Reseller: _____ Phone: _____