

T₃U Rim Series Table Top Tilt Up Boxes

FSR

Metal Products Group

T₃U RIM Series

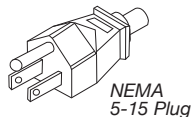

NEMA
5-15 Plug

T₃U-1R-BRS

(Shown with accessory
plates and connectors.)

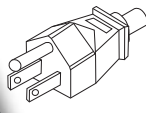

NEMA
5-15 Plug

T₃U-2R-BLK

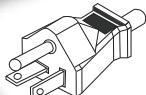

NEMA
5-20 Plug

T₃U-3R-BLK

(Shown with
accessory plates
and connectors.)

Introducing FSR's expanded line of table box solutions...

The T₃U RIM Series (Table Top Tilt Up) table boxes.

Designed expressly for applications requiring multiple access boxes within the same table, the FSR T₃U RIM Series handles data, power, and AV connections in a low profile box.

You can match almost any decor with the T₃U RIM Series cover finish selection. Colors include Black, brushed Brass or brushed Nickel. The T₃U RIM Series easily installs in any table surface with thickness ranging from a minimum .75" to a maximum of 2.75". In the open position, the T₃U RIM Series cover protrudes a mere 1.19" from the table top. Under the table, the T₃U RIM Series extends only 4.25" from the table top surface.

The FSR T₃U RIM Series offer a variety of connection schemes through the use of interchangeable snap in connectors and mounting plates. This allows the plates to be populated by the installer and can be changed as the need arises. FSR offers a complete line of connectors and plates to satisfy most installation requirements. (See options on the following pages).

NOTE: T₃U-1 and T₃U-2 models have a 6' NEMA 5-15 SJ cordset. The T₃U-3 model has a 9' NEMA 5-20 SJ cordset.

FSR Inc.

244 Bergen Boulevard, Woodland Park, NJ 07424

Phone: 973.785.4347 · Fax: 973.785.420

Web: www.fsrinc.com · E-mail: sales@fsrinc.com



LIT 1134G

T3U-1

T3U-1 Connector Plate View

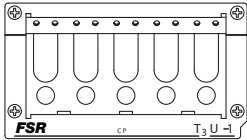
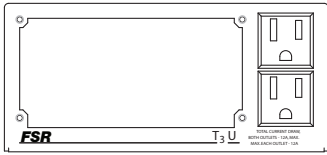

T3U-1-CP

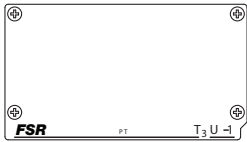

T3U-1-PT

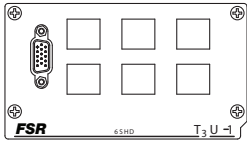

T3U-1-6SHD

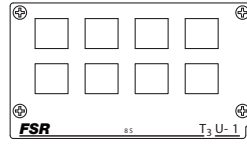

T3U-1-8S

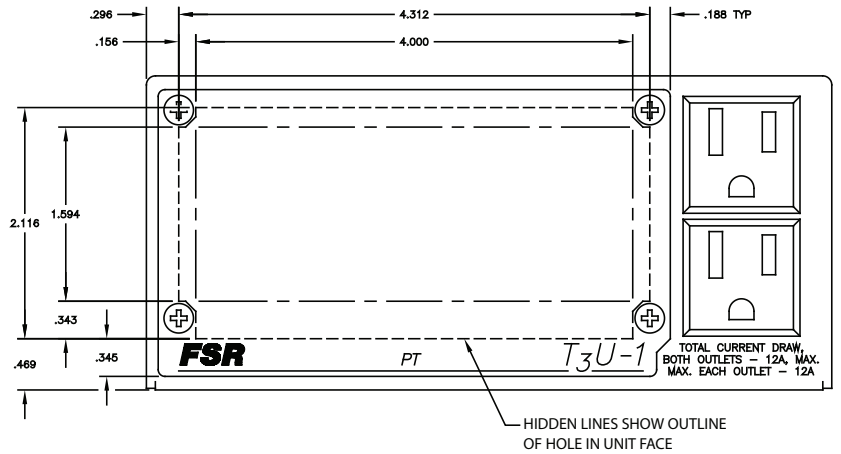

T3U-2

Connector Plate View

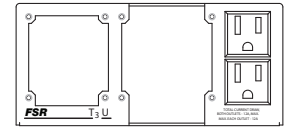

Left Plate Options

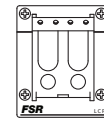

T3U-2-LCP

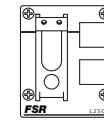

T3U-2-L2SCP

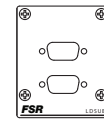

T3U-2-LDSUB

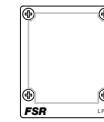

T3U-2-LPT

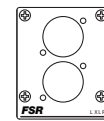

T3U-2-LXLR

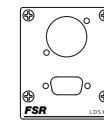

T3U-2-LDSXL
No Connectors

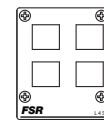

T3U-2-L4S

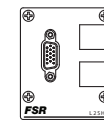

T3U-2-L2SHD

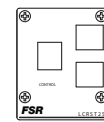

T3U-2-LCRST2S

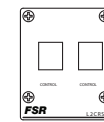

T3U-2-L2CRST

Right Plate Options

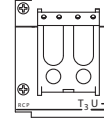

T3U-2-RCP

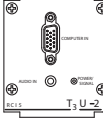

T3U-2-RCIS

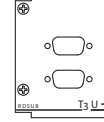

T3U-2-RDSUB
No Connectors



T3U-2-RPT
No Connectors

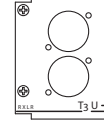

T3U-2-RXLR
No Connectors

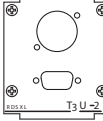

T3U-2-RDSXL
No Connectors

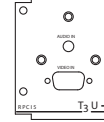

T3U-2-RPCIS

T3U-2

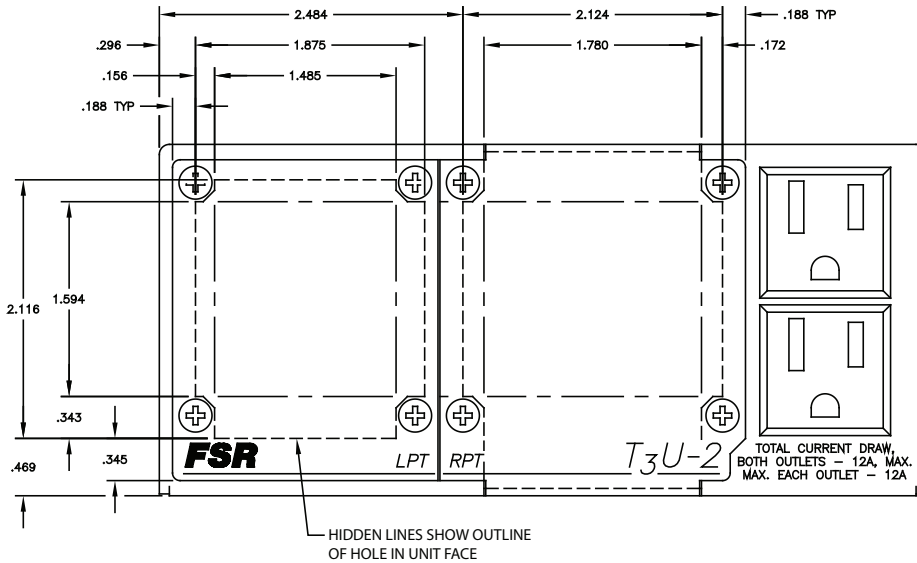

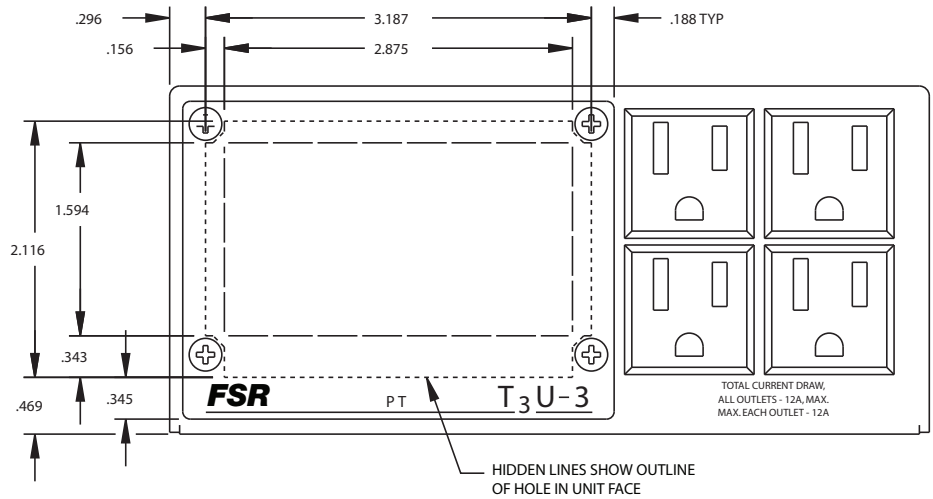
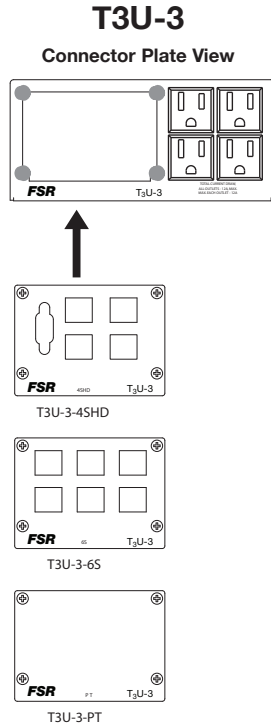

SNAP IN CONNECTORS AVAILABLE (ALL MODELS)

SS-RJ45* *SS-RJ45-WHT or IVO= Punch Down SS-RJ45-BLK = Pass Thru	SS-RJCAT6 CAT 6 to Punch Down (Black Only)	SS-RJ11* *SS-RJ11-WHT or IVO= Punch Down SS-RJ11-BLK = Pass Thru	SS-LC Fiber LC Pass Thru (Black Only)	SS-HDMI HDMI Pass Thru (White and Black Only)	SS-BNC BNC Pass Thru	SS-SCON S-Video Connector Pass Thru
SS-FCON F Connector Pass Thru	SS-RCA-R Red RCA Pass Thru	SS-RCA-B Black RCA Pass Thru	SS-RCA-Y Yellow RCA Pass Thru	SS-MINI 3.5mm Stereo to Solder	SS-SWMMOM Momentary Switch	SS-SWMAIN Maintained Switch
SS-CBLNK Blank Insert	SS-USBA USB A Pass Thru (Black Only)	SS-USBAHW USB A to Punch Down (Black Only)	SS-USBB USB B Pass Thru (Black Only)	SS-USBBHW USB B to Punch Down (Black Only)	SS-USB-CHRG USB Universal 10W Charging Port (black only) with Power Supply	

SNAP IN CONNECTOR ORDERING DETAILS

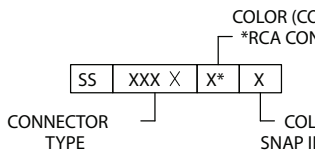

ORDERING INFORMATION

MODEL	FINISH	ACCEPTS <i>(see connector plate view)</i>
T3U-1R-BLK	BLACK	ONE T3U-1 CONNECTOR PLATE
T3U-1R-BRS	BRUSHED BRASS	ONE T3U-1 CONNECTOR PLATE
T3U-1R-NKL	BRUSHED NICKEL	ONE T3U-1 CONNECTOR PLATE
T3U-2R-BLK	BLACK	ONE SET OF T3U-2 LEFT AND RIGHT CONNECTOR PLATES
T3U-2R-BRS	BRUSHED BRASS	ONE SET OF T3U-2 LEFT AND RIGHT CONNECTOR PLATES
T3U-2R-NKL	BRUSHED NICKEL	ONE SET OF T3U-2 LEFT AND RIGHT CONNECTOR PLATES
T3U-3R-BLK	BLACK	ONE T3U-3 CONNECTOR PLATE
T3U-3R-BRS	BRUSHED BRASS	ONE T3U-3 CONNECTOR PLATE
T3U-3R-NKL	BRUSHED NICKEL	ONE T3U-3 CONNECTOR PLATE

TYPICAL INSTALLATION FOR ALL T3U TABLE BOXES

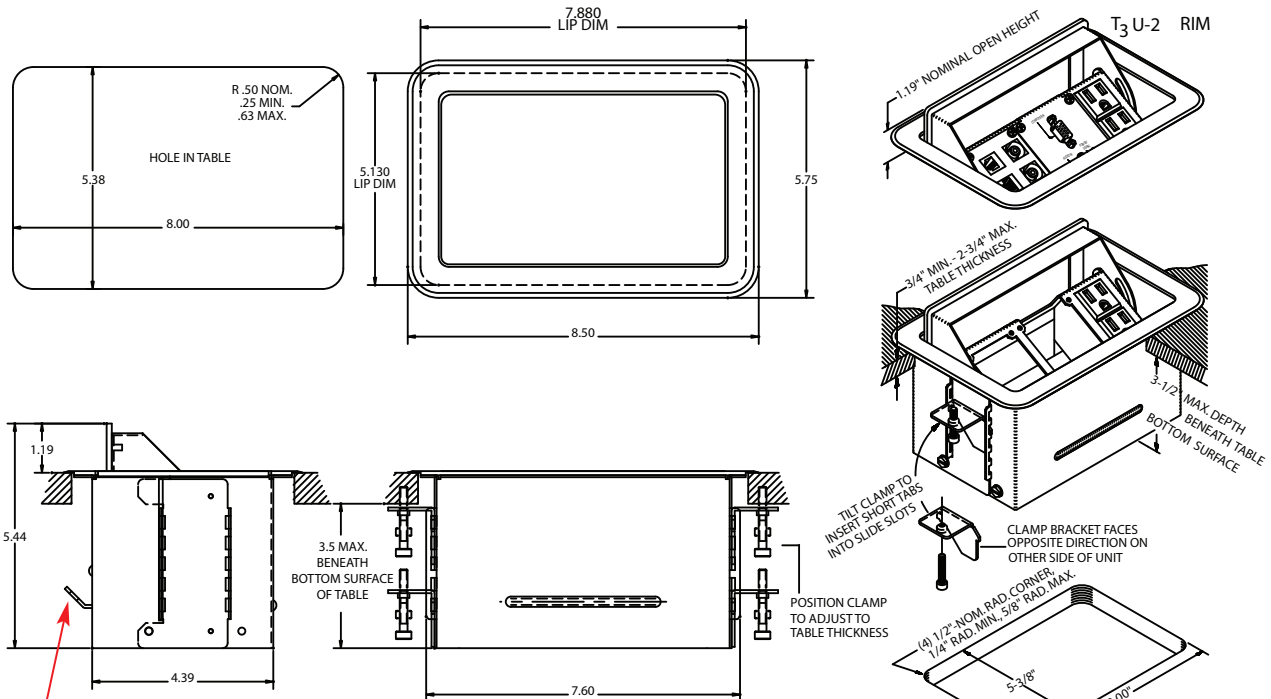

Tie wrap bracket(s) can be removed to provide additional connector clearance.

NOTE: T3U-1 and T3U-2 models have a 6' NEMA 5-15 SJ cordset.
The T3U-3 model has a 9' NEMA 5-20 SJ cordset.

SIMILAR FSR PRODUCT OFFERINGS

The T3-AC2 and T3-PC1D are perfect table boxes for single users, where convenient access to network drops, ac power sources and video/audio displays are required. The small footprint provides an unobtrusive complement to any decor.



T3-AC2



T3-PC1D



244 Bergen Boulevard, Woodland Park, NJ 07424
Phone: 973.785.4347 · Fax: 973.785.4207
Web: www.fsrinc.com · E-mail: sales@fsrinc.com

Specifications are subject to change without notice.

