

DIN-LI Line input module

- Eliminates hum and buzz caused by ground loops
- Delivers exceptionally low distortion down to 20 Hz
- Ruler flat frequency response from 5 Hz to 40 kHz
- Plug and play easy to use, no power required



The Iso•Max DIN-LI is a single channel line input isolator designed to eliminate noise in professional balanced audio systems by isolating the input of the connected device.

The design begins with 35 mm DIN rail molded in gray UL94-VO flame retardant Noryl format that snaps into place for easy installation in NEMA enclosures via removable screw-down wire terminal. Plug and play easy to use, this passive interface does not require any power to work. Inside is a Jensen high performance transformer that is able to withstand signal levels to +19 dB @ 20 Hz without discernible distortion. This provides galvanic isolation between the input and output to eliminate hum and buzz caused by ground loops, rejecting noise by as much as 124 dB. To further optimize the performance, a choice of connection point options enable the user to determine the most appropriate grounding scheme to suit the installation.

Simply connect the DIN-LI between the source and the input destination to eliminate ground loops, electromagnetic interference (EMI) and RFI problems. The DIN-LI will quietly go to work without introducing distortion, phase shift or artifact of any kind.

Dimensions

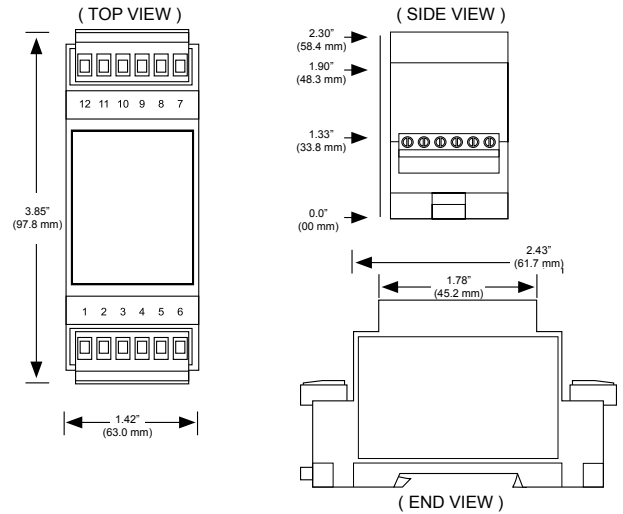

Module Schematic Diagram

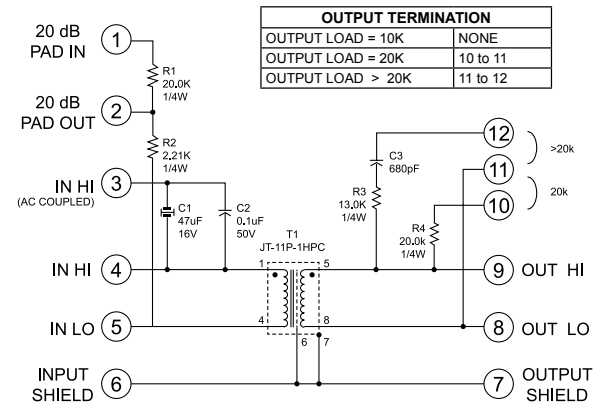

Applications

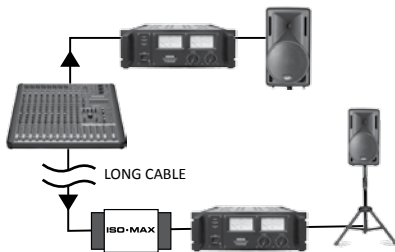

DIN-LI in a PA system

Eliminating noise in a PA system can sometimes take hours of trouble shooting, particularly when the mixer, amplifiers and speakers are distanced apart. Simply connect the DIN-LI at the input of your amplifier to instantly eliminate ground loop hum and buzz.

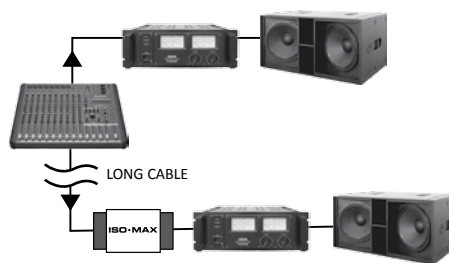

DIN-LI isolating subs

The use of sub woofers in a PA system has become common in most touring setups. Use the DIN-LI to isolate the sub-walker amplifier racks to eliminate ground loops without affecting the audio signal path. The DIN-LI is able to withstand tremendous signal levels without distortion.

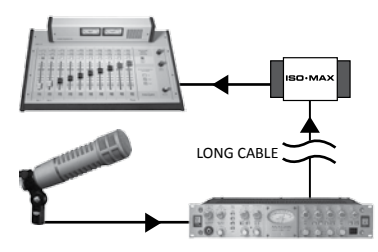

DIN-LI in the studio

Recording and broadcast studios require a noise-free signal transfer while delivering the most accurate sound possible. The Iso•Max DIN-LI eliminates ground loops and lowers RF without introducing distortion, phase shift or artifact.

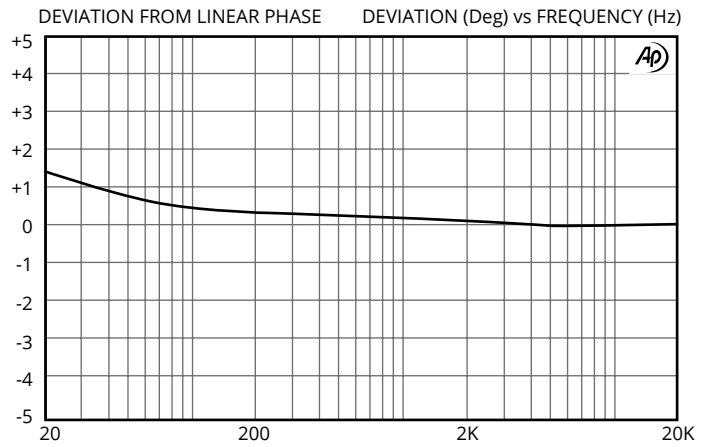
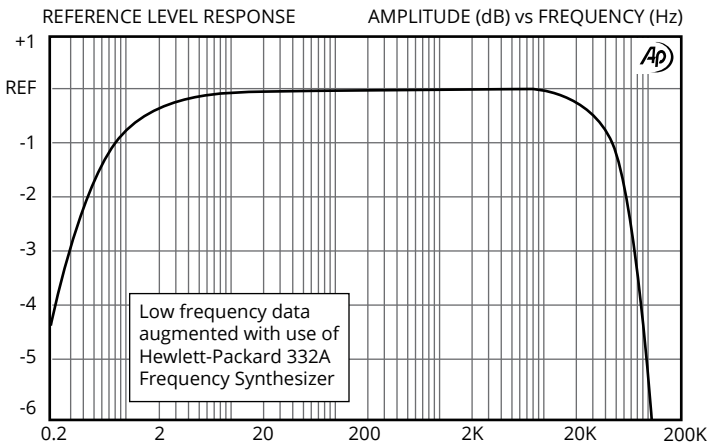
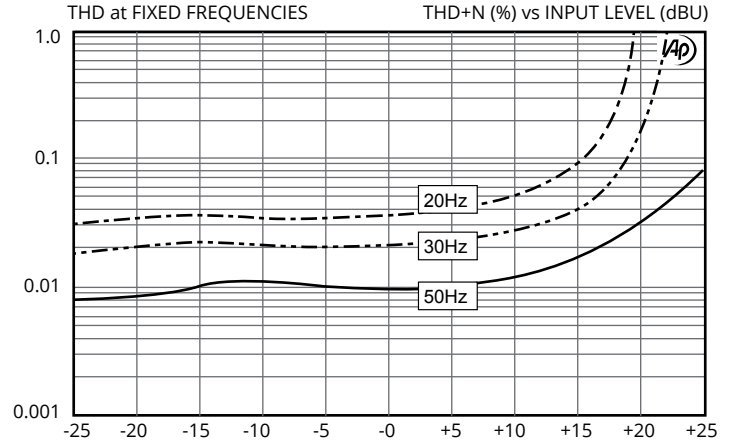
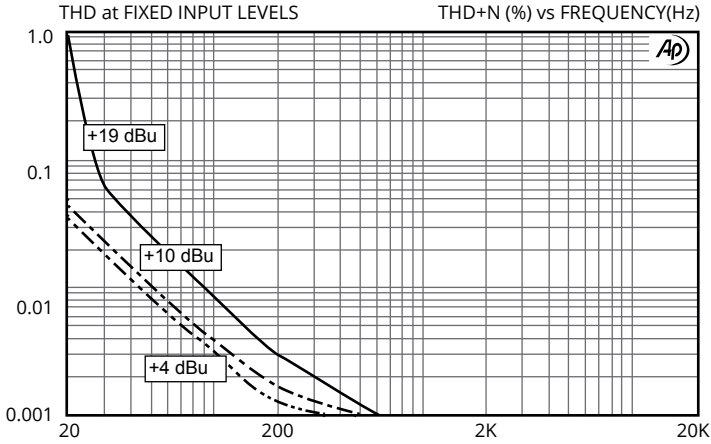

PARAMETER	CONDITIONS	MINIMUM	TYPICAL	MAXIMUM
Input impedance, Zi	1 kHz, +4 dBu, test circuit 1	13.0 kΩ	14.1 kΩ	15.0 kΩ
Voltage Gain	1 kHz, +4 dBu, test circuit 1	-3.2 dB	-3.0 dB	-2.8 dB
Magnitude response, ref 1 kHz	20 Hz, +4 dBu, test circuit 1, Rs = 600 Ω	-0.15 dB	-0.03 dB	±0.0 dB
	20 Hz, +4 dBu, test circuit 1, Rs = 600 Ω	-0.35 dB	-0.20 dB	±0.0 dB
Deviation from linear phase (DLP)	20 Hz, 20 kHz, +4 dBu, test circuit 1, Rs = 600 Ω		+1.4/-0°	±2.0°
Distortion (THD)	1 kHz, +4 dBu, test circuit 1, Rs = 600 Ω		<0.001%	
	20 Hz, +4 dBu, test circuit 1, Rs = 600 Ω		0.04%	0.10%
Maximum 20 Hz input level	1% THD, test circuit 1, Rs = 600 Ω	+17 dBu	+19 dBu	
Common - mode rejection ratio (CMRR) 600 Ω balanced source	60 Hz, test circuit 2		124 dB	
	3 kHz, test circuit 2	85 dB	95 dB	
Common - mode rejection ratio (CMRR) 600 Ω unbalanced source	60 Hz, test circuit 3		95 dB	
	3 kHz, test circuit 3		85 dB	
Output impedance, Zo	1 kHz, test circuit 1, Rs = 600 Ω		3.2 kΩ	
Optimal cable length	input			
	output		1 m (3')	3 m (10')
Turns ratio		0.999:1	1.000:1	1.001:1
Temperature range	operation or storage	0°C		70°C
Breakdown voltage*	primary or secondary to shield and case, 60 Hz, 1 minute test duration	250 V RMS		

All levels are input unless noted

Test Circuit 1:

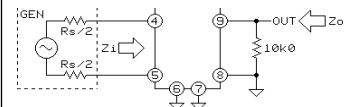

Test Circuit 2:

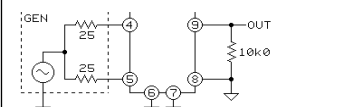

Test Circuit 3:

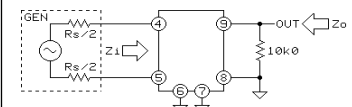

All minimum and maximum specifications are guaranteed. Unless noted otherwise, all specifications apply at 25°C. Specifications subject to change without notice. All information herein is believed to be accurate and reliable, however no responsibility is assumed for its use nor for any infringements of patents which may result from its use. No license is granted by implication or otherwise under any patent or patent rights of Jensen Transformers, Inc.

*IMPORTANT NOTE: THIS PRODUCT IS NOT INTENDED FOR USE IN CIRCUMSTANCES WHERE THE DC OR PEAK AC VOLTAGE BETWEEN INPUT AND OUTPUT CONNECTIONS EXCEEDS 34 VOLTS OR WHERE ITS FAILURE COULD CAUSE INJURY OR DEATH.