

MB9640WW

Double-Sided Magnetic Whiteboard

Product Specifications

Item Number	MB9640WW
Material	Painted Steel
Frame	Aluminum; 1" edging
Surface Material	Magnetic Painted Steel
Full Dimensions	99"W x 23"D x 69"H
Board Dimensions	96"W x 40"H
Base Dimensions	99"W x 23"D
Tray Style	Full Length
Casters (4)	2" casters; two with locking brakes
Actual Weight	65 lbs.
Shipping Method	Freight
Shipping Carton Dimensions	99"W x 50"D x 2"H
Shipping Weight	76 lbs.
Assembly Required	Yes

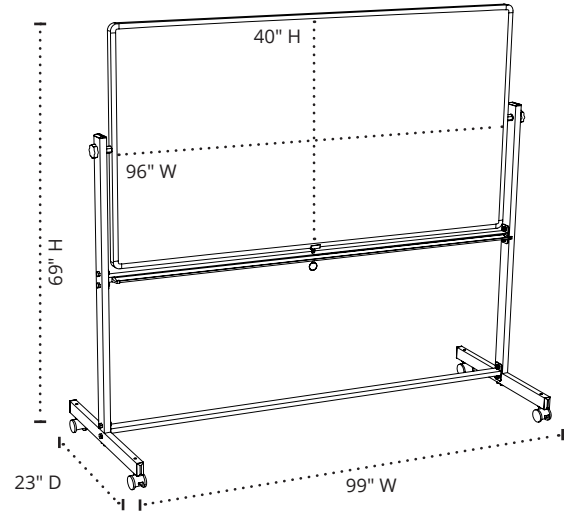

**To Order, Call Your
Sales Representative
or 800-323-4656**