

# RIB Series

riser bases

RIB Series Riser bases provide advanced cable management

## features:

- 1/8" thick fully welded construction
- Riser bases allow for field rough-in prior to arrival of racks and enclosures
- Riser bases act as a lower cable chase for passing cables between racks in multi-bay installations
- Ideal for use in raised floor installations when used with optional VFEET and ANGLE / WANGLE / DANGLE / WMANGLE / BANGLE / SANGLE
- Available in custom widths, depths, heights and configurations
- Durable black textured powder coat finish

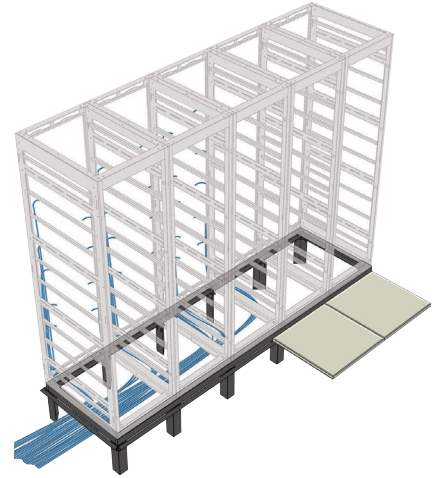

## specifications:

Riser base shall be Middle Atlantic Products model # RIB-\_-\_-\_- (see chart for available models) to accommodate \_\_\_ qty (refer to chart) \_\_\_ (WRK / DRK / MRK / VRK / VMRK / BGR / WMRK / SNE) Series \_\_\_" depth racks. Riser base shall be constructed of 11-gauge steel. Riser base shall be 2-1/2" H x \_\_\_" W x \_\_\_" D (refer to chart). Riser base shall have one knockout on each side for cable pass-through measuring 1.71" H x \_\_\_" W (refer to chart for width dimension). Riser bases shall be phosphate pre-treated and finished a durable textured black powder coat. Riser base shall be warranted to be free from defects in material or workmanship under normal use and conditions for the lifetime of the product. Riser base shall comply with the requirements of RoHS EU Directive 2002/95/EC.

\* Seismic Riser base option available (see SRB Spec Sheet 96-01027)

Customizable specification clips available at [middleatlantic.com](http://middleatlantic.com)



## options:

Raised floor riser feet shall be Middle Atlantic Products model # VFEET-\_-\_-12 for \_\_\_ (refer to chart on page 3) bay installations for use with \_\_\_ (refer to chart on page 3) bay RIB series riser base. Raised floor riser feet shall be 11.5" tall, constructed of 11-gauge steel, and designed for 12" raised floors. Raised floor riser feet shall be phosphate pre-treated and finished in a durable black powder coat.

Support angles shall be Middle Atlantic Products model # ANGLE-\_-\_- (for use when mounting MRK / VRK / VMRK Series racks) (refer to chart on page 4) / WANGLE-\_\_\_ (for use when mounting WRK Series racks) (refer to chart) for use with \_\_\_ (refer to chart on page 4) / DANGLE-\_\_\_ (for use when mounting DRK Series Racks) (refer to chart) / WMANGLE-\_\_\_ (for use when mounting WMRK Series Racks) (refer to chart) / BANGLE-\_\_\_ (for use when mounting BGR Series Racks) / SANGLE-\_\_\_ (for use when mounting SNE Series Racks) (refer to chart). Support angles shall be constructed from 11-gauge steel. Support angles shall be phosphate pre-treated and finished in a durable black powder coat.

what **great systems** are built on.™

A brand of **legrand**

**Middle Atlantic Products**

[middleatlantic.com](http://middleatlantic.com) | [middleatlantic.ca](http://middleatlantic.ca)

96-923 / rev h / 10-6-16

# VFEET Raised Floor

## basic dimensions

all dimensions in inches unless otherwise noted [all dimensions in brackets are in millimeters]

bottom view

(riser base shown upside down to show VFEET positioning)

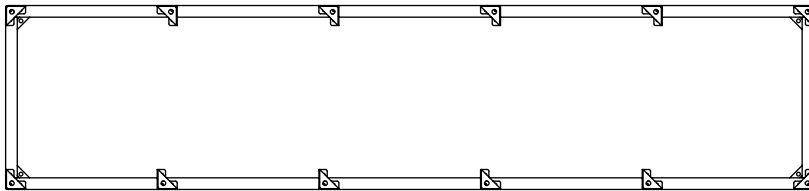

side view

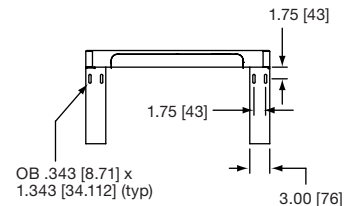

front view

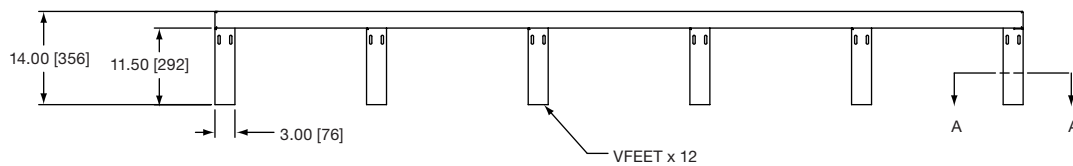

section A-A

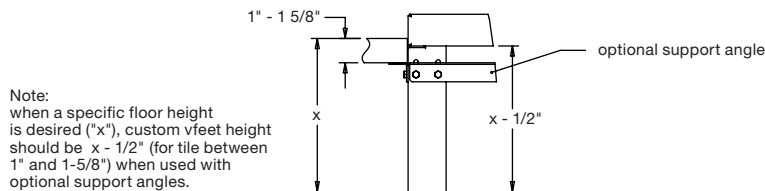

0.69 [17.53] floor mounting holes in VFEET x 12

VFEET raised floor riser feet			
Part #	# of Feet	Used On	# of Racks Accommodated
VFEET-1-12	4	RIB-1	1
VFEET-2-12	6	RIB-2	2
VFEET-3-12	8	RIB-3	3
VFEET-4-12	10	RIB-4	4
VFEET-5-12	12	RIB-5	5

what **great systems** are built on.™

A brand of **legrand**

**Middle Atlantic Products**

middleatlantic.com | middleatlantic.ca

# RIB Series Riser Bases

## basic dimensions

all dimensions in inches unless otherwise noted [all dimensions in brackets are in millimeters]

Part #	A Overall Width	B Overall Depth	C Floor Mounting Holes	D Floor Mounting Holes	E Knockout Width	# of Racks Accommodated
RIB-1-WRK-27	24.25 [616]	27.63 [702]	19.65 [499]	23.00 [584]	16.10 [409]	1
RIB-2-WRK-27	48.53 [1233]	27.63 [702]	43.93 [1116]	23.00 [584]	16.10 [409]	2
RIB-3-WRK-27	72.81 [1849]	27.63 [702]	68.21 [1733]	23.00 [584]	16.10 [409]	3
RIB-4-WRK-27	97.09 [2466]	27.63 [702]	92.49 [2349]	23.00 [584]	16.10 [409]	4
RIB-5-WRK-27	121.37 [3083]	27.63 [702]	116.77 [2966]	23.00 [584]	16.10 [409]	5
RIB-1-WRK-32	24.25 [616]	32.63 [829]	19.65 [499]	28.00 [711]	21.10 [536]	1
RIB-2-WRK-32	48.53 [1233]	32.63 [829]	43.93 [1116]	28.00 [711]	21.10 [536]	2
RIB-3-WRK-32	72.81 [1849]	32.63 [829]	68.21 [1733]	28.00 [711]	21.10 [536]	3
RIB-4-WRK-32	97.09 [2466]	32.63 [829]	92.49 [2349]	28.00 [711]	21.10 [536]	4
RIB-5-WRK-32	121.37 [3083]	32.63 [829]	116.77 [2966]	28.00 [711]	21.10 [536]	5
RIB-1-DRK-31	30.00 [762]	31.40 [789]	25.40 [645]	26.80 [681]	19.87 [508]	1
RIB-2-DRK-31	60.03 [1525]	31.40 [789]	55.43 [1408]	26.80 [681]	19.87 [508]	2
RIB-3-DRK-31	90.06 [2288]	31.40 [789]	85.46 [2171]	26.80 [681]	19.87 [508]	3
RIB-1-DRK-36	30.00 [762]	36.00 [914]	25.40 [645]	31.40 [798]	24.47 [622]	1
RIB-2-DRK-36	60.03 [1525]	36.00 [914]	55.43 [1408]	31.40 [798]	24.47 [622]	2
RIB-3-DRK-36	90.06 [2288]	36.00 [914]	85.46 [2171]	31.40 [798]	24.47 [622]	3
RIB-1-DRK-42	30.00 [762]	42.00 [1067]	25.40 [645]	37.40 [950]	30.47 [774]	1
RIB-2-DRK-42	60.03 [1525]	42.00 [1067]	55.43 [1408]	37.40 [950]	30.47 [774]	2
RIB-3-DRK-42	90.06 [2288]	42.00 [1067]	85.46 [2171]	37.40 [950]	30.47 [774]	3
RIB-1-WMRK-36	23.94 [608]	36.00 [914]	19.34 [491]	31.40 [797]	24.47 [622]	1
RIB-2-WMRK-36	47.91 [1217]	36.00 [914]	43.30 [1100]	31.40 [797]	24.47 [622]	2
RIB-3-WMRK-36	71.87 [1826]	36.00 [914]	67.27 [1709]	31.40 [797]	24.47 [622]	3
RIB-1-WMRK-42	23.94 [608]	42.00 [1067]	19.34 [491]	37.40 [950]	30.47 [774]	1
RIB-2-WMRK-42	47.91 [1217]	42.00 [1067]	43.30 [1100]	37.40 [950]	30.47 [774]	2
RIB-3-WMRK-42	71.87 [1826]	42.00 [1067]	67.27 [1709]	37.40 [950]	30.47 [774]	3
RIB-1-WMRK-48	23.94 [608]	48.00 [1219]	19.34 [491]	43.40 [1102]	36.47 [926]	1
RIB-2-WMRK-48	47.91 [1217]	48.00 [1219]	43.30 [1100]	43.40 [1102]	36.47 [926]	2
RIB-3-WMRK-48	71.87 [1826]	48.00 [1219]	67.27 [1709]	43.40 [1102]	36.47 [926]	3
RIB-1-MRK-26	22.00 [559]	26.40 [671]	17.40 [442]	21.80 [554]	14.87 [378]	1
RIB-2-MRK-26	44.03 [1118]	26.40 [671]	39.43 [1002]	21.80 [554]	14.87 [378]	2
RIB-3-MRK-26	66.06 [1678]	26.40 [671]	61.46 [1561]	21.80 [554]	14.87 [378]	3
RIB-4-MRK-26	88.09 [2237]	26.40 [671]	83.49 [2121]	21.80 [554]	14.87 [378]	4
RIB-5-MRK-26	110.12 [2797]	26.40 [671]	105.52 [2680]	21.80 [554]	14.87 [378]	5
RIB-1-MRK-31	22.00 [559]	31.40 [798]	17.40 [442]	26.80 [681]	19.87 [505]	1
RIB-2-MRK-31	44.03 [1118]	31.40 [798]	39.43 [1002]	26.80 [681]	19.87 [505]	2
RIB-3-MRK-31	66.06 [1678]	31.40 [798]	61.46 [1561]	26.80 [681]	19.87 [505]	3
RIB-4-MRK-31	88.09 [2237]	31.40 [798]	83.49 [2121]	26.80 [681]	19.87 [505]	4
RIB-5-MRK-31	110.12 [2797]	31.40 [798]	105.52 [2680]	26.80 [681]	19.87 [505]	5
RIB-1-MRK-36	22.00 [559]	36.00 [914]	17.40 [442]	31.40 [798]	24.47 [622]	1
RIB-2-MRK-36	44.03 [1118]	36.00 [914]	39.43 [1002]	31.40 [798]	24.47 [622]	2
RIB-3-MRK-36	66.06 [1678]	36.00 [914]	61.46 [1561]	31.40 [798]	24.47 [622]	3
RIB-4-MRK-36	88.09 [2237]	36.00 [914]	83.49 [2121]	31.40 [798]	24.47 [622]	4
RIB-5-MRK-36	110.12 [2797]	36.00 [914]	105.52 [2680]	31.40 [798]	24.47 [622]	5
RIB-1-MRK-42	22.00 [559]	42.00 [1067]	17.40 [442]	37.40 [950]	30.47 [774]	1
RIB-2-MRK-42	44.03 [1118]	42.00 [1067]	39.43 [1002]	37.40 [950]	30.47 [774]	2
RIB-3-MRK-42	66.06 [1678]	42.00 [1067]	61.46 [1561]	37.40 [950]	30.47 [774]	3
RIB-1-BGR-27	23.0 [584]	27.0 [686]	18.62 [473]	21.18 [538]	15.47 [393]	1
RIB-1-BGR-32	23.0 [584]	32.0 [813]	18.62 [473]	26.18 [665]	20.47 [520]	1
RIB-1-BGR-38	23.0 [584]	38.0 [965]	18.62 [473]	32.18 [817]	26.47 [672]	1
RIB-2-BGR-27	46.03 [1169]	27.0 [686]	41.65 [1058]	21.18 [538]	15.47 [393]	2
RIB-2-BGR-32	46.03 [1169]	32.0 [813]	41.65 [1058]	26.18 [665]	20.47 [520]	2
RIB-2-BGR-38	46.03 [1169]	38.0 [965]	41.65 [1058]	32.18 [817]	26.47 [672]	2
RIB-3-BGR-27	69.06 [1754]	27.0 [686]	64.68 [1643]	21.18 [538]	15.47 [393]	3
RIB-3-BGR-32	69.06 [1754]	32.0 [813]	64.68 [1643]	26.18 [665]	20.47 [520]	3
RIB-3-BGR-38	69.06 [1754]	38.0 [965]	64.68 [1643]	32.18 [817]	26.47 [672]	3
RIB-4-BGR-27	92.09 [2339]	27.0 [686]	87.71 [2228]	21.18 [538]	15.47 [393]	4
RIB-4-BGR-32	92.09 [2339]	32.0 [813]	87.71 [2228]	26.18 [665]	20.47 [520]	4
RIB-4-BGR-38	92.09 [2339]	38.0 [965]	87.71 [2228]	32.18 [817]	26.47 [672]	4
RIB-5-BGR-27	115.12 [2924]	27.0 [686]	110.74 [2813]	21.18 [538]	15.47 [393]	5
RIB-5-BGR-32	115.12 [2924]	32.0 [813]	110.74 [2813]	26.18 [665]	20.47 [520]	5
RIB-5-BGR-38	115.12 [2924]	38.0 [965]	110.74 [2813]	32.18 [817]	26.47 [672]	5

5 bay

top view

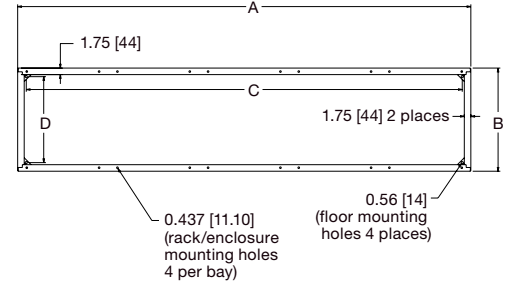

front view

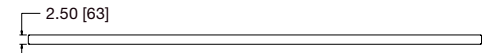

side view

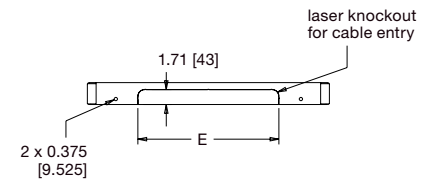

what great systems are built on.™

A brand of **legrand**

**MA**

**Middle Atlantic Products**

middleatlantic.com | middleatlantic.ca

# Raised Floor Support Angles

## basic dimensions

all dimensions in inches unless otherwise noted [all dimensions in brackets are in millimeters]

Part #	A Overall Width	B Overall Depth	Used On	Rack Series	# of Racks Accommodated
ANGLE-1	21.75 [552]	29.15 [740]	VFEET-1-12	MRK/VRK/VMRK 26" and 31" depth racks	1
ANGLE-2	43.78 [1112]	29.15 [740]	VFEET-2-12	MRK/VRK/VMRK 26" and 31" depth racks	2
ANGLE-3	65.81 [1672]	29.15 [740]	VFEET-3-12	MRK/VRK/VMRK 26" and 31" depth racks	3
ANGLE-4	87.84 [2231]	29.15 [740]	VFEET-4-12	MRK/VRK/VMRK 26" and 31" depth racks	4
ANGLE-5	109.87 [2791]	29.15 [740]	VFEET-5-12	MRK/VRK/VMRK 26" and 31" depth racks	5
ANGLE-1-36	21.75 [552]	38.75 [984]	VFEET-1-12	MRK/VRK/VMRK 36" depth racks	1
ANGLE-2-36	43.78 [1112]	38.75 [984]	VFEET-2-12	MRK/VRK/VMRK 36" depth racks	2
ANGLE-3-36	65.81 [1672]	38.75 [984]	VFEET-3-12	MRK/VRK/VMRK 36" depth racks	3
ANGLE-4-36	87.84 [2231]	38.75 [984]	VFEET-4-12	MRK/VRK/VMRK 36" depth racks	4
ANGLE-5-36	109.87 [2791]	38.75 [984]	VFEET-5-12	MRK/VRK/VMRK 36" depth racks	5
DANGLE-1-31	29.75 [756]	29.15 [740]	VFEET-1-12	DRK 31" depth racks	1
DANGLE-2-31	59.78 [1518]	29.15 [740]	VFEET-2-12	DRK 31" depth racks	2
DANGLE-3-31	89.91 [2284]	29.15 [740]	VFEET-3-12	DRK 31" depth racks	3
WANGLE-1	24.00 [610]	30.38 [777]	VFEET-1-12	WRK 27" and 31" depth racks	1
WANGLE-2	48.28 [1226]	30.38 [777]	VFEET-2-12	WRK 27" and 31" depth racks	2
WANGLE-3	72.56 [1843]	30.38 [777]	VFEET-3-12	WRK 27" and 31" depth racks	3
WANGLE-4	96.84 [2460]	30.38 [777]	VFEET-4-12	WRK 27" and 31" depth racks	4
WANGLE-5	121.12 [3076]	30.38 [777]	VFEET-5-12	WRK 27" and 31" depth racks	5
ANGLE-1-42	21.75 [552]	38.75 [984]	VFEET-1-12	MRK 42" depth racks	1
ANGLE-2-42	43.78 [1112]	38.75 [984]	VFEET-2-12	MRK 42" depth racks	2
ANGLE-3-42	65.81 [1672]	38.75 [984]	VFEET-3-12	MRK 42" depth racks	3
DANGLE-1-3642	29.75 [756]	38.75 [984]	VFEET-1-12	DRK 36" and 42" depth racks	1
DANGLE-2-3642	59.78 [1518]	38.75 [984]	VFEET-2-12	DRK 36" and 42" depth racks	2
DANGLE-3-3642	89.91 [2284]	38.75 [984]	VFEET-3-12	DRK 36" and 42" depth racks	3
WMANGLE-1-3642	23.69 [602]	38.75 [984]	VFEET-1-12	WMRK 36" and 42" depth racks	1
WMANGLE-2-3642	47.65 [1210]	38.75 [984]	VFEET-2-12	WMRK 36" and 42" depth racks	2
WMANGLE-3-3642	71.62 [1819]	38.75 [984]	VFEET-3-12	WMRK 36" and 42" depth racks	3
WMANGLE-1-48	23.69 [602]	44.75 [984]	VFEET-1-12	WMRK 48" depth racks	1
WMANGLE-2-48	47.65 [1210]	44.75 [984]	VFEET-2-12	WMRK 48" depth racks	2
WMANGLE-3-48	71.62 [1819]	44.75 [984]	VFEET-3-12	WMRK 48" depth racks	3
BANGLE-1	22.75 [578]	30 [762]	VFEET-1-12	BGR 27" and 32" depth racks	1
BANGLE-1-38	22.75 [578]	41 [1041]	VFEET-1-12	BGR 38" depth racks	1
BANGLE-2	45.78 [1163]	30 [762]	VFEET-2-12	BGR 27" and 32" depth racks	2
BANGLE-2-38	45.78 [1163]	41 [1041]	VFEET-2-12	BGR 38" depth racks	2
BANGLE-3	68.81 [1748]	30 [762]	VFEET-3-12	BGR 27" and 32" depth racks	3
BANGLE-3-38	68.81 [1748]	41 [1041]	VFEET-3-12	BGR 38" depth racks	3
BANGLE-4	91.84 [2333]	30 [762]	VFEET-4-12	BGR 27" and 32" depth racks	4
BANGLE-4-38	91.84 [2333]	41 [1041]	VFEET-4-12	BGR 38" depth racks	4
BANGLE-5	114.87 [2918]	30 [762]	VFEET-5-12	BGR 27" and 32" depth racks	5
BANGLE-5-38	114.87 [2918]	41 [1041]	VFEET-5-12	BGR 38" depth racks	5
SANGLE-24-1-3642	23.69 [602]	38.75 [984]	VFEET-1-12	SNE Series 24" wide 36" and 42" depth racks	1
SANGLE24-1-48	23.69 [602]	44.75 [1137]	VFEET-1-12	SNE Series 24" wide 48" depth racks	1
SANGLE27-1-3642	27.19 [691]	38.75 [984]	VFEET-1-12	SNE Series 27" wide 36" and 42" depth racks	1
SANGLE27-1-48	27.19 [691]	44.75 [1137]	VFEET-1-12	SNE Series 27" wide 48" depth racks	1
SANGLE30-1-3642	29.75 [756]	38.75 [984]	VFEET-1-12	SNE Series 30" wide 36" and 42" depth racks	1
SANGLE30-1-48	29.75 [756]	44.75 [1137]	VFEET-1-12	SNE Series 30" wide 48" depth racks	1
SANGLE24-2-3642	47.65 [1210]	38.75 [984]	VFEET-2-12	SNE Series 24" wide 36" and 42" depth racks	2
SANGLE24-2-48	47.65 [1210]	44.75 [1137]	VFEET-2-12	SNE Series 24" wide 48" depth racks	2
SANGLE27-2-3642	54.85 [1393]	38.75 [984]	VFEET-2-12	SNE Series 27" wide 36" and 42" depth racks	2
SANGLE27-2-48	54.85 [1393]	44.75 [1137]	VFEET-2-12	SNE Series 27" wide 48" depth racks	2
SANGLE30-2-3642	59.65 [1515]	38.75 [984]	VFEET-2-12	SNE Series 30" wide 36" and 42" depth racks	2
SANGLE30-2-48	59.65 [1515]	44.75 [1137]	VFEET-2-12	SNE Series 30" wide 48" depth racks	2
SANGLE24-3-3642	71.71 [1821]	38.75 [984]	VFEET-3-12	SNE Series 24" wide 36" and 42" depth racks	3
SANGLE24-3-48	71.71 [1821]	44.75 [1137]	VFEET-3-12	SNE Series 24" wide 48" depth racks	3
SANGLE27-3-3642	82.51 [2096]	38.75 [984]	VFEET-3-12	SNE Series 27" wide 36" and 42" depth racks	3
SANGLE27-3-48	82.51 [2096]	44.75 [1137]	VFEET-3-12	SNE Series 27" wide 48" depth racks	3
SANGLE30-3-3642	89.71 [2279]	38.75 [984]	VFEET-3-12	SNE Series 30" wide 36" and 42" depth racks	3
SANGLE30-3-48	89.71 [2279]	44.75 [1137]	VFEET-3-12	SNE Series 30" wide 48" depth racks	3

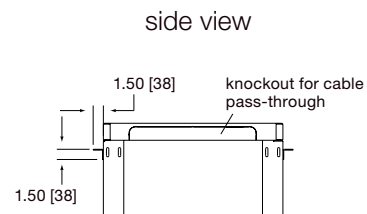
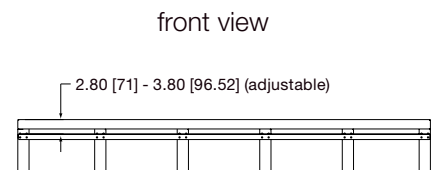
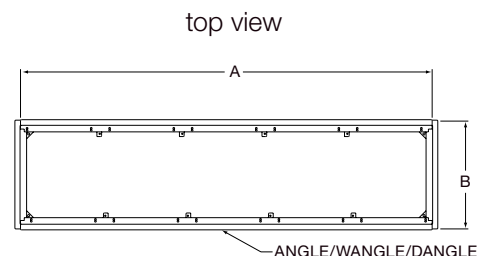

# Riser Bases for SNE Series

## basic dimensions

all dimensions in inches unless otherwise noted [all dimensions in brackets are in millimeters]

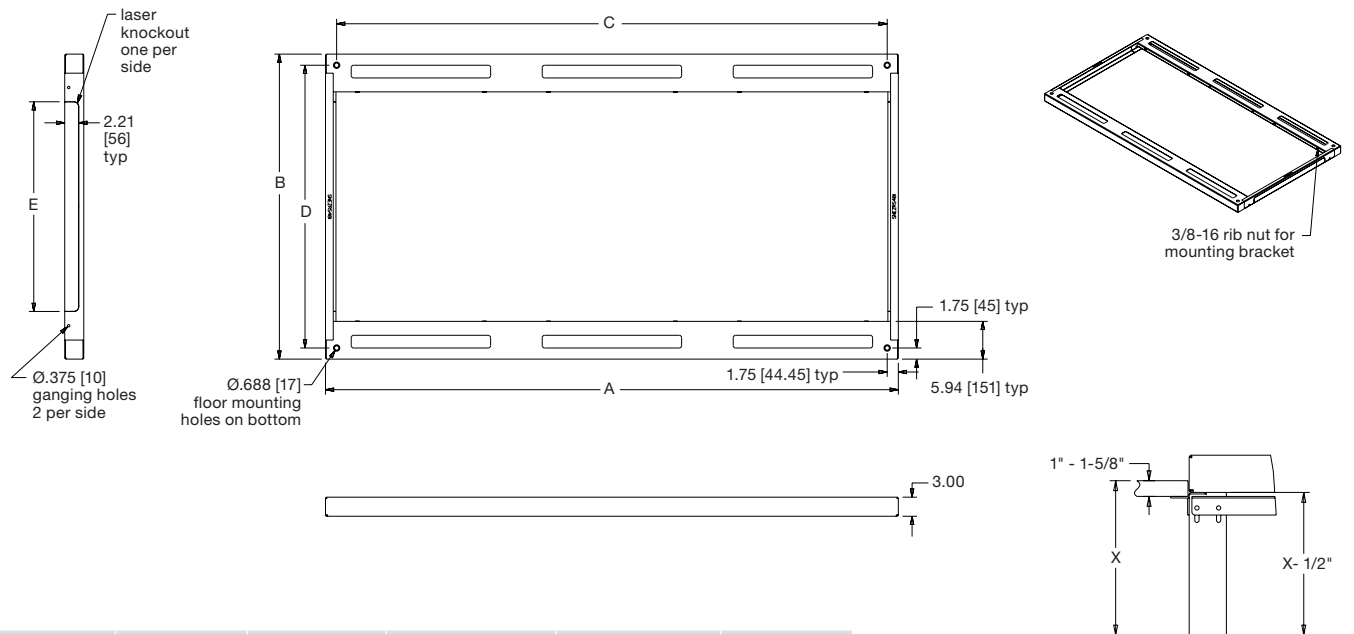

Part Number	A	B	C	D	E
RIB-1-SNE24-36	23.94 [608]	36.00 [914]	20.44 [519.2]	32.5 [825.5]	21.00 [533]
RIB-1-SNE24-42	23.94 [608]	42.00 [1067]	20.44 [519.2]	38.5 [977.9]	27.00 [686]
RIB-1-SNE24-48	23.94 [608]	48.00 [1219]	20.44 [519.2]	44.5 [1130.3]	33.00 [838]
RIB-1-SNE27-36	27.63 [702]	36.00 [914]	24.13 [587.5]	32.5 [825.5]	21.00 [533]
RIB-1-SNE27-42	27.63 [702]	42.00 [1067]	24.13 [587.5]	38.5 [977.9]	27.00 [686]
RIB-1-SNE27-48	27.63 [702]	48.00 [1219]	24.13 [587.5]	44.5 [1130.3]	33.00 [838]
RIB-1-SNE30-36	30.03 [763]	36.00 [914]	26.53 [673.9]	32.5 [825.5]	21.00 [533]
RIB-1-SNE30-42	30.03 [763]	42.00 [1067]	26.53 [673.9]	38.5 [977.9]	27.00 [686]
RIB-1-SNE30-48	30.03 [763]	48.00 [1219]	26.53 [673.9]	44.5 [1130.3]	33.00 [838]
RIB-2-SNE24-36	48.09 [1221]	36.00 [914]	44.59 [1132.6]	32.5 [825.5]	21.00 [533]
RIB-2-SNE24-42	48.09 [1221]	42.00 [1067]	44.59 [1132.6]	38.5 [977.9]	27.00 [686]
RIB-2-SNE24-48	48.09 [1221]	48.00 [1219]	44.59 [1132.6]	44.5 [1130.3]	33.00 [838]
RIB-2-SNE27-36	55.29 [1404]	36.00 [914]	51.79 [1315.5]	32.5 [825.5]	21.00 [533]
RIB-2-SNE27-42	55.29 [1404]	42.00 [1067]	51.79 [1315.5]	38.5 [977.9]	27.00 [686]
RIB-2-SNE27-48	55.29 [1404]	48.00 [1219]	51.79 [1315.5]	44.5 [1130.3]	33.00 [838]
RIB-2-SNE30-36	60.09 [1526]	36.00 [914]	56.59 [1437.4]	32.5 [825.5]	21.00 [533]
RIB-2-SNE30-42	60.09 [1526]	42.00 [1067]	56.59 [1437.4]	38.5 [977.9]	27.00 [686]
RIB-2-SNE30-48	60.09 [1526]	48.00 [1219]	56.59 [1437.4]	44.5 [1130.3]	33.00 [838]
RIB-3-SNE24-36	72.15 [1833]	36.00 [914]	68.65 [1743.7]	32.5 [825.5]	21.00 [533]
RIB-3-SNE24-42	72.15 [1833]	42.00 [1067]	68.65 [1743.7]	38.5 [977.9]	27.00 [686]
RIB-3-SNE24-48	72.15 [1833]	48.00 [1219]	68.65 [1743.7]	44.5 [1130.3]	33.00 [838]
RIB-3-SNE27-36	82.95 [2107]	36.00 [914]	79.45 [2018]	32.5 [825.5]	21.00 [533]
RIB-3-SNE27-42	82.95 [2107]	42.00 [1067]	79.45 [2018]	38.5 [977.9]	27.00 [686]
RIB-3-SNE27-48	82.95 [2107]	48.00 [1219]	79.45 [2018]	44.5 [1130.3]	33.00 [838]
RIB-3-SNE30-36	90.15 [2290]	36.00 [914]	86.65 [2201]	32.5 [825.5]	21.00 [533]
RIB-3-SNE30-42	90.15 [2290]	42.00 [1067]	86.65 [2201]	38.5 [977.9]	27.00 [686]
RIB-3-SNE30-48	90.15 [2290]	48.00 [1219]	86.65 [2201]	44.5 [1130.3]	33.00 [838]

Note:  
when a specific floor height is desired ("X"), custom veelet height should be X - 1/2" (for tile between 1" and 1-5/8").