

Features

- SMPTE 424M, SMPTE 292M, and SMPTE 259M compliant
- HD-BNC Mini 75Ω connectors
- Rx Equalizer:
 - Equalizes Belden 1694A cable up to: 140m at 2.97Gb/s, 200m at 1.485Gb/s and 400m at 270Mb/s
- Integrated Tx Cable Driver
- Supports DVB-ASI at 270Mb/s
- Supports video pathological patterns for SD-SDI, HD-SDI and 3G-SDI
- Hot-pluggable
- Pb-free and RoHS compliant
- Operating temperature range: -40°C to 80°C
- 58.5mm x 13.4mm x 8.6mm SFP Package

General Description

The SFP-3G-TXRX-HD-BF-LR is an electrical SFP Transceiver module designed to transmit and receive SDI signals up to 2.97Gbps over 75Ω coaxial cables via HD-BNC Mini connectors. Cable Driver slew rate is automatically configured in order to achieve compliance to SMPTE 424M/ SMPTE 292M and SMPTE 259M. Equalizer features DC restoration to compensate for the DC content of SMPTE pathological test patterns.

It is also hot-pluggable solution for in field system upgrade and maintenance. The SFP-3G-TXRX-HD-BF-LR is interchangeable with others optical or coaxial video SFP improving product flexibility.

1 Functional Block Diagram

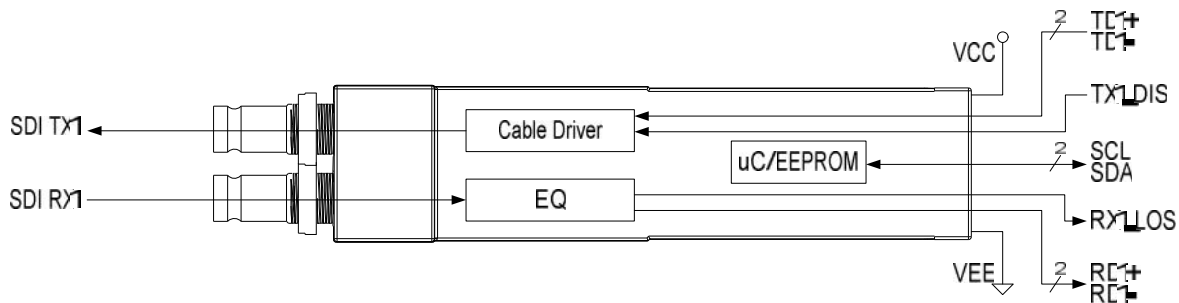

Block Diagram

2 Functional Description

The SFP-3G-TXRX-HD-BF-LR Transceiver is a Small Form Factor Pluggable (SFP) module with coaxial interface. HD-BNC Mini connectors are used to interface the module with 75Ω coaxial cables.

The SFP-3G-TXRX-HD-BF-LR Transceiver automatically equalizes the received signal (RX1) for the cable loss and retimes serial digital video data conforming to the SMPTE 424M, 292M and 259M.

3 Mechanical Specification

Item	Description
Connector Type	HD-BNC Mini (75Ω)
Plug Diameter	Up to 7.8mm external HD-BNC Mini plug diameter (Standard)
Ganged Cages	Ganged cages mounting supported
Stacked Cages	Stacked cages mounting supported
Mechanical release	Simple pull up mechanical release system to disengage the module from his cage

TX1 RX1

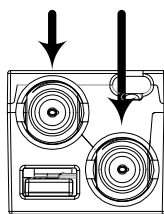

Physical channel position

TOP VIEW

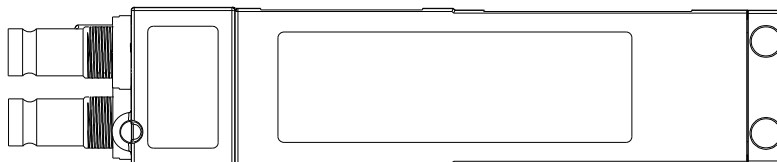

FRONT VIEW

SIDE VIEW

REAR VIEW

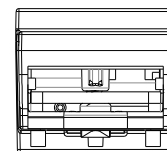
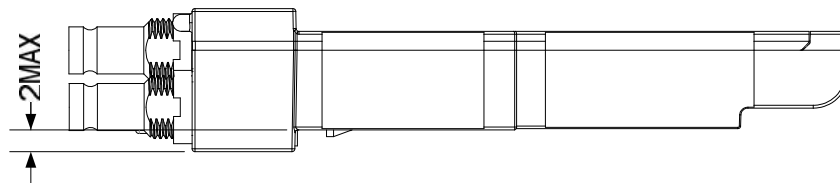
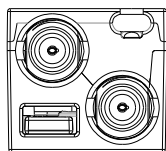

BOTTOM VIEW

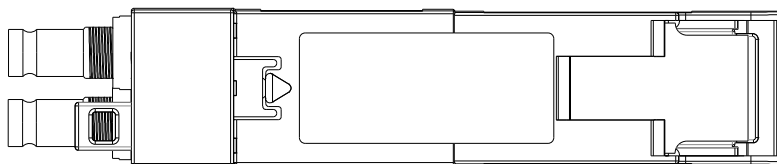

SFP-3G-TXRX-HD-BF-LR Note: All Dimensions in mm

4 Ordering Information

Part Number	Type	Package
SFP-3G-TXRX-HD-BF-LR	Rx/Tx	SFP



5 Related Products

Complete Plura SFP Modules Selection

Model #	Type	Coaxial	Fiber	Hybrid
SFP-3G-TXRX-HD-BF-LR	Rx/Tx	HD-BNC-Mini	N/A	N/A
SFP-3G-TXRX-HD-BF-LR-C	Rx/Tx-rclk	HD-BNC-Mini	N/A	N/A
SFP-3G-2RX-1310F-LC-MH	2Rx	N/A	LC-Single Mode	N/A
SFP-3G-2TX-1310F-LC-MH	2Tx	N/A	LC-Single Mode	N/A
SFP-3G-TXRX-1310F-LC-MH	Rx/Tx	N/A	LC-Single Mode	N/A
SFP-3G-TX-HDMIF-TypeD	Rx	HDMI-TypeD	N/A	N/A
SFP-3G-2RX-1310F-LC-BF	2Rx	HD-BNC-Mini	LC-Single Mode	YES
SFP-3G-2TX-HD-BF-LR	2Tx	HD-BNC-Mini	N/A	N/A
SFP-3G-2TX-HD-BF-LR-C	2Tx-rclk	HD-BNC-Mini	N/A	N/A

The product is in a development phase and specifications are subject to change without notice. Plura reserves the right to modify and/or update the product specifications at any time.

Plura Broadcast, Inc. - West Coast
1930 W. Quail Ave Phoenix, AZ 85027
Tel: (602) 944-1044 Fax: (602) 324-9688

Plura Broadcast, Inc. - East Coast
67 Grand Avenue Massapequa, NY 1175
Tel: (516) 997-5675 Fax: (516) 593-7900

www.plurasfp.com