



*Route - Transport - Extend - Convert - Scale*



Multimedia Products for HDMI and DVI



# Quick Reference Guide

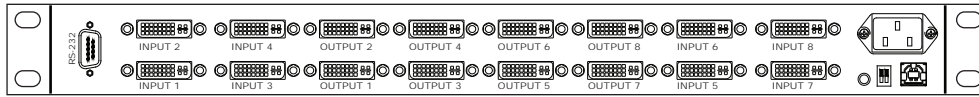

PRO-8X8-DVI  
8X8 DVI ROUTER

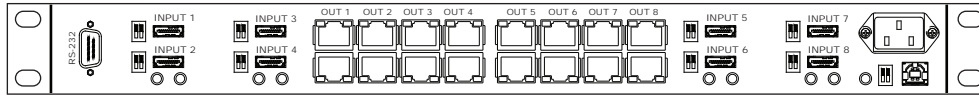

PRO-8X8-HDMI-CAT  
8X8 HDMI ROUTER  
w/CAT5/6 EXTENDERS

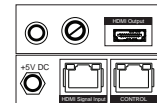

RECEIVER UNIT  
CATx INPUT  
HDMI OUTPUT  
8 units per system.

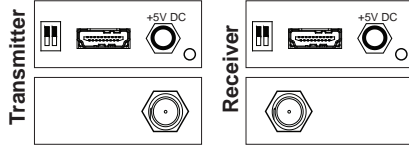

PRO-HDMI-BNC  
HDMI VIDEO  
OVER ONE COAX

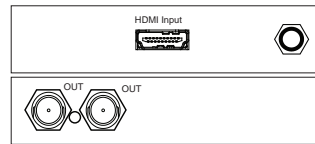

PRO-3GPG  
3G/HD/SD PATTERN  
GENERATOR  
W / HDMI INPUT

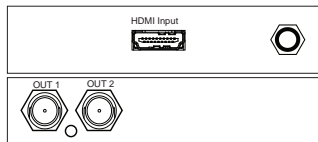

PRO-HDMI2HD  
HDMI INPUT TO  
3G/HD/SDI OUTPUT

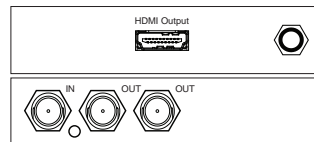

PRO-HD2HDMI  
3G/HD/SD VIDEO  
TO HDMI OUTPUT  
W/ LOOPING HD/SD

page 9

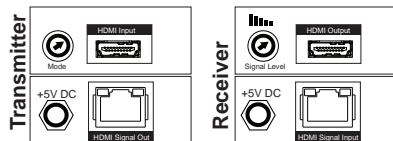

PRO-HDMI-CAT  
HDMI EXTENDERS  
OVER CAT5/6

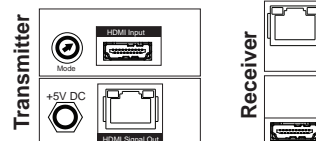

PRO-HDMI-CAT-PLG  
HDMI EXTENDER TX  
AND RX PLUG OVER CAT5/6

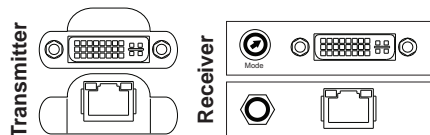

PRO-DVI-CAT  
DVI EXTENDERS  
OVER CAT5/6

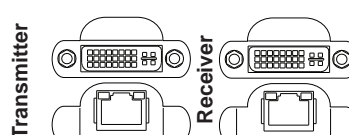

PRO-DVI-CAT-PLG  
DVI DIRECT PLUGS  
OVER CAT5/6

# 8X8 HDMI Matrix

## PESA Part No. PRO-8X8-HDMI-CAT

The PRO-8X8-HDMI-CAT is an 8x8 HDMI over CAT5 Matrix with IR Control Path that provides the most flexible and cost effective solution in the market to route high definition video sources plus multi-channel (up to 7.1-channel) digital audio from any of the eight HDMI sources to the remote displays at the same time. Through low cost CAT5/5e LAN cables, not only can high quality video and audio be transmitted to the display sites, but also users can switch among 8 HDMI sources using the push button or remote control. With a single power design at the source site, each remote module is easily installed without power supply. Further, the built-in IR extension function allows remote users access to the DVD player, PS3 or any HDMI equipped devices directly.

### FEATURES:

- HDMI 1.3c compliant
- HDCP compliant
- Allows any source to be displayed on multiple displays at the same time
- Allows any HDMI display to view any source at any time
- Supports 7.1 channel digital audio
- Flexible EDID management



### TECHNICAL

HDMI Compliance	HDMI 1.3c
HDCP Compliance	Yes
Video Bandwidth	Singlelink 225MHz (6.75Gbps)
Video Support	480i/480p/720p/1080i/1080p60
Audio Support	Surround Sound (up to 7.1) or Stereo Audio
HDMI over Cable (1080p)	35m (115ft) over CAT5e 40m (130ft) over CAT6
HDMI over Cable (1080i/720p)	50m (165ft) over CAT5e 55m (180ft) over CAT6
HDMI Equalization	8 level digital rotary control
Input TMDS signal	1.2V p-p
Input / Output Switcher Ports	Inputs – HDMI Outputs – RJ-45 (TMDS) Outputs – RJ-45 (DDC) Outputs – 5X IR socket for IR blaster
Input / Output on Remote Modules	Input – RJ-45 (TMDS) Input – RJ-45 (DDC) Output – HDMI Output – IR socket for IR receiver
HDMI Connector Style	Type A (19 pin female)
RJ-45 Connector Style	WE/SS 8P8C with LED indicators
IR Remote	Electro-optical 38kHz
RS-232 Connector Style	9 Pin D-Sub
IR Connector Style	3.5mm earphone jack
DIP Switch Settings	(SW-1 – SW8) EDID and audio settings (SW Main) 4 Pin mode and firmware updates

Dimensions for Switcher	17" X 11.4" X 1.7" (440mm X 290mm X 44mm)
Dimensions for Receivers (X8)	3.5" X 3.3" X 1" (90mm X 85mm X 25mm)
Mounting Style for Switcher	1RU with removable mounting ears
Mounting Style for Receivers	Throw-down with wall-mount ears
Power Input	100-240VAC, 50/60Hz
Power Consumption	60 W (max)
Operating Temperature	0 - 40C (32-104F)
Storage Temperature	-20 to 60C (-4 to 140F)
Relative Humidity	20 to 90% ( non condensing)
Package Content	1X – 8X8 Switcher 2X – Mounting Ears 1X – IR remote control 8X – IR receivers 8X – Receiver (RX) 1X – User Manual

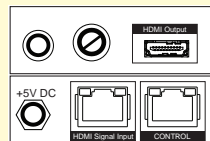

**RECEIVER UNIT**  
CATx INPUT  
HDMI OUTPUT  
8 units per system.

# 8X8 DVI Matrix

## PESA Part No. PRO-8X8-DVI



PESA's PRO-8X8-DVI is an 8 input and 8 output DVI matrix switcher for DVI-D resolutions from 640X480@60Hz to 1920X1200@60Hz including all HDTV resolutions for 720p and 1080p. Based on the DVI DDWG 1.0 standard for single link, the PRO-8X8-DVI allows any source to be displayed on multiple monitors at the same time. The PRO-8X8-DVI contains default EDID and learns the EDID from each display connected. The user switches the panels from a local push button selection, an IR remote, or from an RS-232 control interface. Housed in a compact 1RU high chassis, the PRO-8X8-DVI can be table mounted or rack mounted with the included mounting ears. The unit is supplied with a remote control for IR settings and a CD with setup software.

### FEATURES:

- Supports up to WUXGA (1920X1200@60Hz)
- Matrix Switching for up to 8 DVI Inputs and 8 DVI Outputs
- Supports Video Input for 480p / 720p /1080p
- Built-in RS-232 for External Control via PC or Controller
- Fast Response time: 2-5 seconds for channel switching
- 19" Rack Mountable
- Flexible EDID Management

### TECHNICAL

Specifications	Compliant with DDWG 1.0 (1999)
Number of Inputs	8 DVI-D ( 29 pin female)
Number of Outputs	8 DVI-D ( 29 pin female)
Video Bandwidth	Singlelink (165MHz)
Video Resolutions	VGA (640X480) up to WUXGA (1920X1200) 1680X1050p @60Hz ( 16:9) 1920X1200p @60Hz ( 16:9) 720p and 1080p ( HDTV)
EDID	EDID emulation and learning mode
Control Options	RS-232, USB, or 3.5mm for IR Front panel pushbutton
Settings	4 pin DIP switch for USB / 232 / Firmware update
Mechanical	1RU 17.00 ( 440mm ) X 7.90 (200mm) X 1.70 (44mm) Optional rack mount ears
Weight	5.9lbs / 2675g
Power	AC Power 100-240V
Power Consumption	60W max.
Operating Temperature	0-40 C
Storage Temperature	-20 to 60 C
Relative Humidity	20-90% RH ( non-condensing)

# HDMI Over Single Coaxial Extender

## PESA Part No. PRO-HDMI-BNC



The PESA PRO-HDMI-BNC is a perfect solution for those who need to extend HDMI signals long distance over coax cable. The PESA HDMI extenders can handle resolutions up to 1080p at up to 60m. Installation of the PESA HDMI over coax is quick and easy, simply place the Transmitter unit next to your HDMI source and place the Receiver unit next to your destination. Connect the units with coax cable equivalent to 1694A to achieve distances up to 60m.

### FEATURES:

- HDMI over a single coax
- Perfect video quality up to 1080p/60
- Supports 5.1 or 7.1 Audio
- Extends up to 60m (196 ft) from the HDMI source
- HDMI sources under Full HD resolution (1080p/60 24-bit color) through 1694A coaxial cable
- Supports video resolutions 480i, 576i, 720p, 1080i, and 1080p
- Easy to install and simple to operate

### TECHNICAL

HDMI Compliance	HDMI 1.2a
HDCP Compliance	Yes
Video Bandwidth	Single Link 165MHz ( 4.95Gbps)
Video Support	480i / 480p / 720p / 1080i / 1080p
Audio Support	Surrond sound up to 7.1 or stereo audio
HDMI over Coax	60m (196 ft) Full HD 1080p 24 bit color
HDMI Equalization	Auto
Input TDMS Signal	1.2V p-p
Input DDC Signal	5V p-p, TTL
Transmitter Input	1X HDMI
Transmitter Output	1X BNC
Receiver Input	1X BNC
Receiver Output	1X HDMI
HDMI Connector	Type A ( 19 pin female)
BNC Connector	75 Ohm
Dimensions TX	2.9" X 2.9" X 1.1" (74mm X 73mm X 29mm)
Power Supply	5V 2A DC
Power Consumption	3 W (max)
Operating Temperature	0-40C (32-104F)
Storage Temperature	-20 to 60C (-4 to 140F)
Relative Humidity	20 to 90% ( non condensation)
Package Content	1X - TX Module 1X - RX Module 1X - User Manual 2X - 5V 2A power adapter

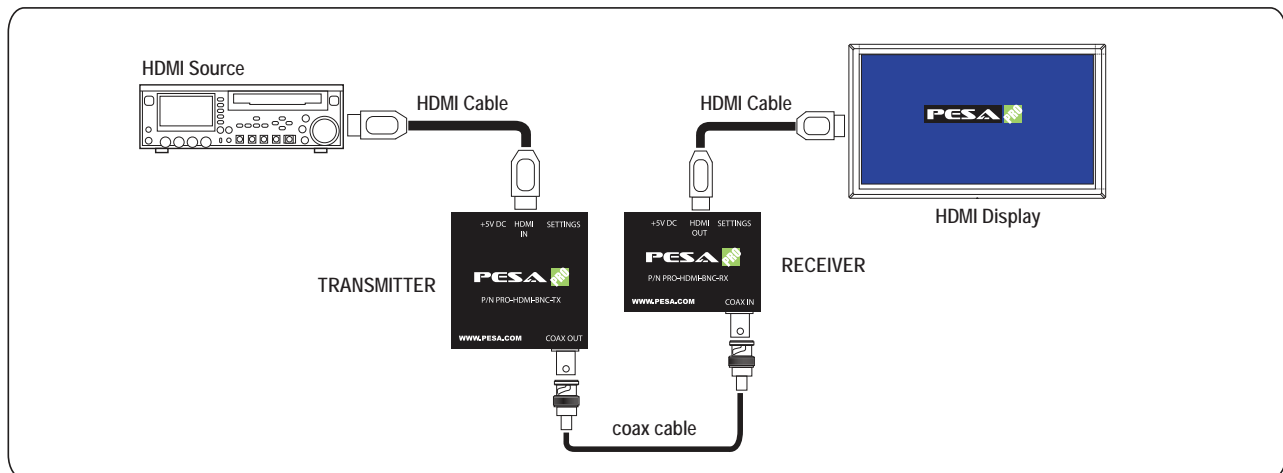

# HDMI to 3G/HD/SD-SDI

## PESA Part No. PRO-HDMI2HD



The PESA PRO-HDMI2HD provides a professional way to convert HDMI to HD/SD SDI in real time. The conversion between SDI and HDMI is pure digital and guarantees no loss transformation for both audio and video. Plus, with up to 8 channels audio support, 7.1 channel or 5.1 channel audio becomes available. The PRO-HDMI2HD also provides 2 low jitter SDI outputs for daisy chain or multiple monitors. With the use of PRO-HDMI2HD, the most popular uncompressed video interface in the consumer world is readily available for professional SDI equipment.

### FEATURES:

Supported high-definition (HD) formats:

NTSC 525@59.94, PAL 625@50

720p@23.98, 720p@24, 720p@25, 720@29.94, 720p@30,

720p@50, 720p@59.94, 720p@60, 1080i@50, 1080i@59.94,

1080i@60, 1080p@23.97, 1080p@24, 1080p@25, 1080p@29.97,

1080p@30, 1080p@50, 1080p@59.94, 1080p@60

Bit Rate: 2.97 Gbps, 2.967 Gbps, 1.485 Gbps, 1.4835 Gbps, 270 Mbps

Auto 3G/HD/SD-SDI detection

HDMI 1.2 supported

Two SDI compliant outputs

External DIP Switch Configuration

### TECHNICAL

SDI Standards	SD-SDI, HD-SDI, 3G-SDI
Auto Standards Detection	Yes
Video Bandwidth	2.97Gbps
Video Support 3G-SDI	1080p50/59.94/60 (4:2:2) 1080p 23.97/24/25/29.97/30 (4:4:4) 1080i50/59.94/60 (4:4:4) 720p24/25/50/59.94/60 (4:4:4)
Video Support HD-SDI	720p50/59.94/60 1035i50/59.94/60 1080i50/59.94/60 1080p24/30 SD at NTSC 59.94Hz / PAL 50Hz
Output Signal Type	SMPTE 259M, 292M, 296M, and 424M
Input Signal Type	HDMI (DVI with adapter)
Impedance	75 Ohm
Audio Mode	7.1, 5.1, Stereo
Cable Equalization	60m (200ft) for 3G-SDI 150m (500ft) for HD-SDI 300m (1000ft) for SDI
Loop Out	2 Equalized and relocked
Input Connectors	1X – HDMI/DVI
Outputs	2X – BNC
BNC type	75Ohm
HDMI connector	Type A (19 pin female)
DIP Switch Connector	Video format / Audio format / groups
Dimensions	6.3" X 4.3" X 1" (160mm X 110mm X 25mm)
Power Supply	5V 4A DC
Power Consumption	3 W (max)
Operating Temperature	0-40C (32-104F)
Storage Temperature	-20 to 60C (-4 to 140F)
Relative Humidity	20 to 90% ( non condensation)
Package Content	1X – Module 1X – User Manual 1X – 5V 4A power adapter

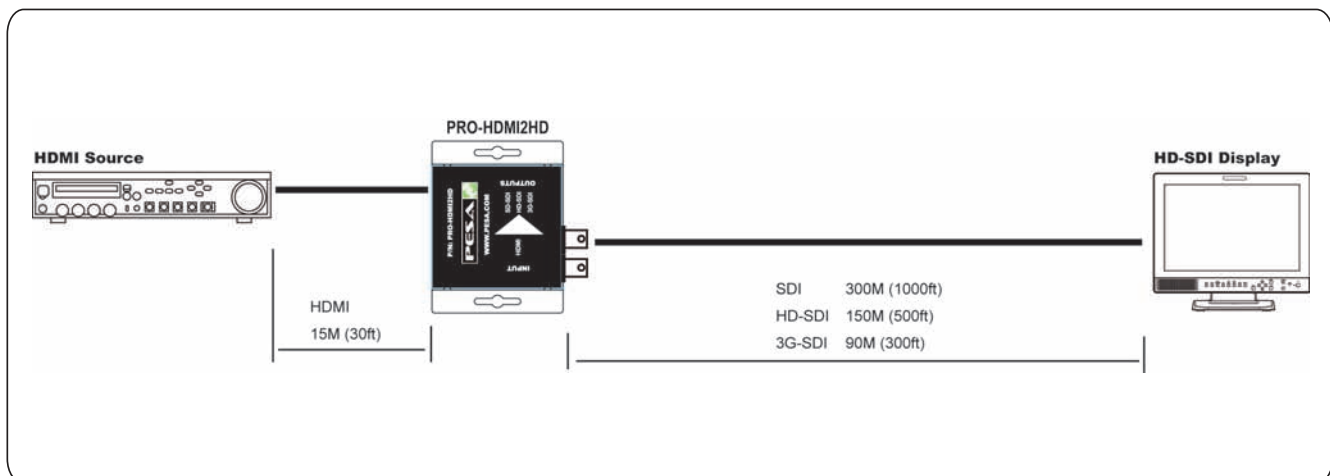



# 3G/HD/SD-SDI to HDMI

## PESA Part No. PRO-HD2HDMI



The PESA PRO-HD2HDMI provides a cost effective way to convert HD/SD-SDI signal to HDMI compliant format. The conversion between SDI and HDMI is pure digital and guarantees no loss transformation for both audio and video. Plus, with up to 8 channels audio support, 7.1 channel or 5.1 channel audio becomes available. The PRO-HD2HDMI also provides 2 low jitter and re-clocked outputs for daisy chain or multiple monitors out.

### FEATURES:

Auto 3G/HD/SD-SDI detection

Supported standard-definition (SD) formats:

NTSC @59.94Hz, PAL @50Hz

Supported high-definition (HD) formats:

1080i @50/59.94/60Hz, 1035i @50/59.94/60Hz,

720p @50/59.94/60Hz

Supported 3G formats(SMPTE 425M, Level A):

1080p @50/59.94/60Hz (4:2:2), 1080p @24/25/30Hz (4:4:4), 1080i

@50/59.94/60Hz (4:4:4), 720p @24/25/50/59.94/60Hz (4:4:4)

2 equalized and re-clocked loop outputs

External DIP Switch Configuration

### Technical

SDI Standards	SD-SDI, HD-SDI, 3G-SDI
Auto Standards Detection	Yes
Video Bandwidth	2.97Gbps
Video Support 3G-SDI	1080p50/59.94/60 (4:2:2) 1080p24/25/30 (4:4:4) 1080i50/59.94/60 (4:4:4) 720p24/25/50/59.94/60 (4:4:4)
Video Support HD-SDI	720p50/59.94/60, 1035i50/59.94/60,1080i50/59.94/60 1080p24/30 SD at NTSC 59.94Hz / PAL 50Hz
Input Signal Type	SMPTE 259M, 292M, 296M, and 424M
Output Signal Type	HDMI (DVI with adapter)
Impedance	75 Ohm
Audio Mode	7.1, 5.1, Stereo
Cable Equalization	60m (200ft) for 3G-SDI 150m (500ft) for HD-SDI 300m (1000ft) for SDI
Loop Out	2 Equalized and reclocked
Input Connectors	1X – BNC
Outputs	1X – HDMI/DVI 2X – BNC
BNC Type	75Ohm
HDMI Connector	Type A (19 pin female)
VGA Connector	HD-15 (15 d-sub)
DIP Switch Connector	Output / Audio / Audio Group / Level Control
Dimensions	6.3" X 4.3" X 1" (160mm X 110mm X 25mm)
Power Supply	5V 4A DC
Power Consumption	2 W (max)
Operating Temperature	0-40C ( 32-104F)
Storage Temperature	-20 to 60C (-4 to 140F)
Relative Humidity	20 to 90% ( non condensation)
Package Content	1X – Module 1X – User Manual 1X – 5V 4A power adapter

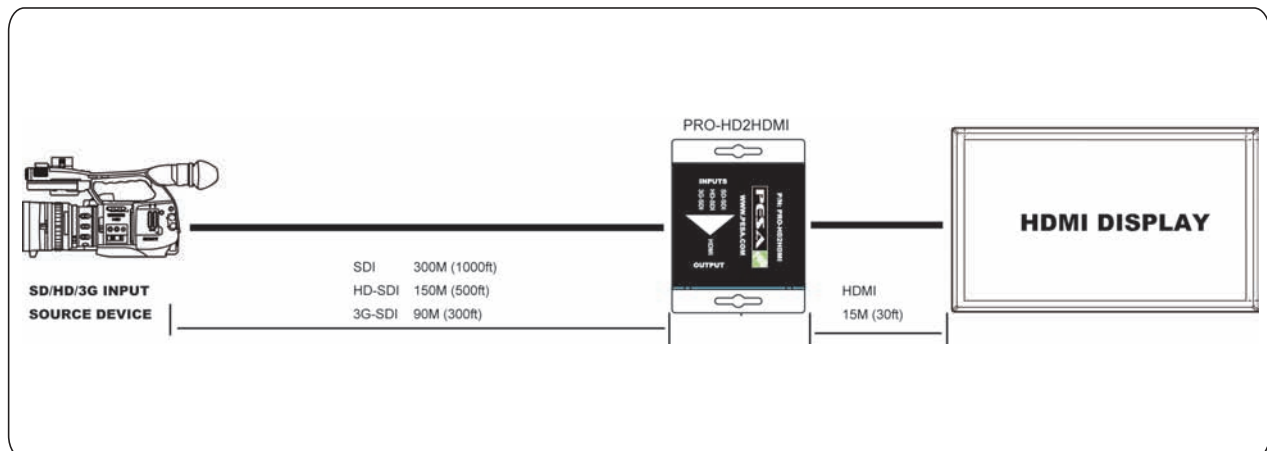

# HDMI over CAT5/6

## PESA Part No. PRO-HDMI-CAT

With only one cost effective CATx cable, users can readily extend HDTV sources from DVD players, Blu-ray Disc player, PS3, PC, and any other DVI and HDMI compliant device to distant display monitors including HDMI/DVI enabled TV sets or LCD PC monitors. The PESA PRO-HDMI-CAT Extender boosts your video/audio transmission distance up to 60m (200ft) in HDTV 1080i format, 40m (130ft) in HDTV 1080p format, and 20m (65ft) in HDTV 1080p with 36 bit color depth. Using the latest in HDMI technology, this device supports deep color video, DTS-HD or Dolby True HD audio. HDCP compliant devices such as DVD players, entertainment gaming devices, and set top boxes can have their signal extended greater distances a minimal cost.

The PRO-HDMI-CAT includes two units: transmitting (TX) and receiving (RX) units. The transmitting unit is used to capture the input HDMI/DVI signals and carry the signals through one RJ-45 connector into one cost effective CAT-5/5e/6 cable. The receiving unit is responsible for equalizing the sent TMDS multimedia data. With an 8-level equalization control knob on the receiving unit, users can adjust the equalization strength to the received TMDS signals accordingly, and therefore optimize the transmission distance between source and destination.

### FEATURES:

- \* HDMI 1.3c compliant
- \* 720p or 1080i up to 60m (200ft) from the HDMI source
- \* 1080p/8bit color up to 40m (130ft) from the HDMI source
- \* 1080p/12bit color up to 20m (65ft) from the HDMI source
- \* HDCP compliant
- \* 8 Level equalization control to minimize skew
- \* 7.1 digital audio over CAT-5/5e cable
- \* Supports DTS-HD and Dolby True HD high bit rate audio



### Technical

HDMI Compliance	HDMI 1.3c
HDCP Compliance	Yes
Video Bandwidth	Singlelink 165Mhz
Video Support	480i/480p/720p/1080i/1080p60 Up to 36-bit color depth
Transmission over Cable (1080p)	40m (130ft) over CAT5e 50m (165ft) over CAT6
Transmission over Cable (1080i/720p)	50m (165ft) over CAT5e 60m (200ft) over CAT6
Audio Support	8 Level Digital Control at RX
Input TMDS Signal	1.2V p-p
Input DDC Signal	5V p-p, TTL
Input / Output Type	TX unit – HDMI to RJ-45 RX unit – RJ-45 to HDMI
HDMI Connector Style	Type A (19 pin female)
RJ-45 Connector Style	WE/SS 8P8C with LED indicators
Rotary Switch	TX = Mode adjust, RX = EQ adjust
Dimensions	3.7" X 2.4" X 1" (93mmX60mmX25mm)
Power Supply	5V 2A DC
Power Consumption	4W max (TX), 1.5W max (RX)
Operating Temperature	0-40C (32-104F)
Storage Temperature	-20 to 60C (-4 to 140F)
Relative Humidity	20 to 90% (non condensation)
Package Content	1X – Transmitter (TX) 1X – Receiver (RX) 1X – User Manual 2X – 5V 2A power adapter

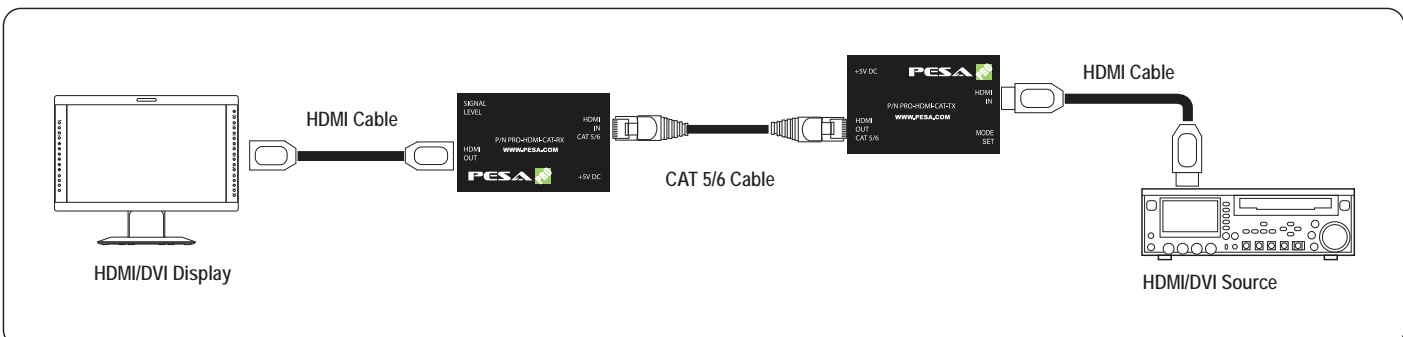



# HDMI over CAT5/6 TX with direct plug RX

## PESA Part No. PRO-HDMI-CAT-PLG

The PESA PRO-HDMI-CAT-PLG can boost your HDMI or DVI video/audio transmission distance up to 25m (80ft) in HDTV. With only one cost effective CATx cable, users can directly plug the receiver into HDTV sources from DVD players, Blu-ray Disc player, PS3, PC, and any other kinds of HDMI compliant devices to distant display monitors including HDMI/DVI enabled TV sets or LCD PC monitors. This cost effective flexibility allows HDCP compliant DVD players or PS3 players to transmit high quality video and audio greater distances at minimal cost.

The PRO-HDMI-CAT-PLG includes two units: transmitting (TX) and receiving (RX) direct plug connector. The transmitting unit is used to capture the input HDMI/DVI signals and carry the signals through one RJ-45 connector into one cost effective CAT-5/5e/6 cable. The transmission distance between the sending and receiving units can be up to 25m (80ft) under HD (720p/1080i) or 15m (50ft) under Full HD (1080p60). With a direct plug to the display, users do not need a power outlet normally required for traditional HDMI over CAT5 receivers.

#### Features:

- \* HDMI 1.3c compliant
- \* 1080i or 720p up to 25m (80ft) from the HDMI source
- \* 1080p up to 15m (50ft) from the HDMI source
- \* HDCP compliant
- \* Supports 7.1 digital audio over CAT 5/5e cable
- \* RX allows direct plug-in to HDMI displays



Technical	
HDMI Compliance	HDMI 1.3c
HDCP Compliance	Yes
Video Bandwidth	Singlelink (165Mhz)
Video Support	480i/480p/720p/1080i/1080p60
	Up to 36-bit color depth
Transmission over Cable (1080p)	15m (50ft) over CAT5e
	18m (65ft) over CAT6
Transmission over Cable (1080i/720p)	25m (80ft) over CAT5e
	30m (100ft) over CAT6
Input TMDs Signal	1.2V p-p
Input DDC Signal	5V p-p, TTL
Input / Output Type	TX unit – HDMI to RJ-45
	RX unit – RJ-45 to HDMI
HDMI Connector Style	Type A (19 pin female)
RJ-45 Connector Style	WE/SS 8P8C with LED indicators
Rotary Switch	TX = Mode adjust
Dimensions	3.7" X 2.4" X 1" (93mm X 60mm X 25mm)
	RX is direct-plug unit
Power Supply	5V 2A DC
Power Consumption	1 W (max)
Operating Temperature	0-40C (32-104F)
Storage Temperature	-20 to 60C (-4 to 140F)
Relative Humidity	20 to 90% (non condensation)
Package Content	1X – Transmitter (TX)
	1X – Receiver (RX)
	1X – User Manual
	2X – 5V 2A power adapter

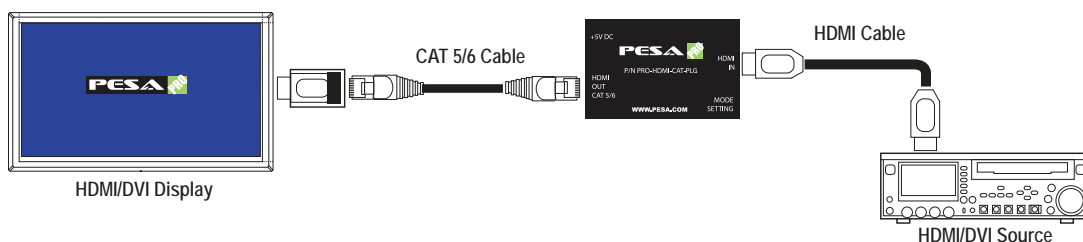

## DVI over CAT5/6 ( Direct Plug)

### PESA Part No. PRO-DVI-CAT-PLG

The PESA PRO-DVI-CAT-PLG extends your PC DVI transmission distance up to 30m/100ft with resolution 1024x768 @60Hz or 15m /50ft with resolutions up to 1920X1200@60Hz. With the PRO-DVI-CAT-PLG, users can transmit high quality digital video of PC applications through one cost effective CAT-5/5e to the remote monitor or projector, instead of using short and expensive DVI cables. With embedded EDID inside the extender, your PC will continue to send the digital video even when the monitor is not connected. The user can then disconnect the monitor, place it in a remote location and reconnect it without rebooting the operating system.

The PRO-DVI-CAT-PLG includes two identical units: transmitting and receiving units. The transmitting unit is connected to your PC DVI output and the receiving unit is connected to the monitor. While successfully connected, the two LED lights on RJ-45 connector will blink. With a compact size and requiring no power, the PRO-DVI-CAT-PLG is the most cost effective choice for bringing your impressive digital video to a remote display.



- Handy DVI-D to RJ-45 Adaptor
- DVI 1.1 compliant
- Extend the transmission distance up to 30m/100ft from the sources at XGA
- Extend the transmission distance up to 15m/50ft from the sources at WUXGA
- LED indicators
- Compact size

## DVI over CAT5/6 with Direct Plug TX

### PESA Part No. PRO-DVI-CAT

The PESA PRO-DVI-CAT extends your PC DVI transmission distance up to 60m/200ft with resolution 1024x768 @60Hz or 30m/100ft for 1920X1200@60Hz. With the PRO-DVI-CAT, users can transmit high quality digital video of PC applications through one cost effective CAT-5/5e to the remote monitor or projector, instead of using short and expensive DVI cables. With embedded EDID inside the extender, your PC will continue to send the digital video even when the monitor is not connected. The user can then disconnects the monitor, place it in a remote location and reconnect it without rebooting the operating system.

The PRO-DVI-CAT includes a direct-plug transmitter unit and a wall mounted receiver unit. The transmitting unit is connected to your PC DVI output and the receiving unit is connected to the monitor. While successfully connected, the two LED lights on RJ-45 connector will blink. With a compact size, the PRO-DVI-CAT is a cost effective choice for bringing impressive digital video to any remote display.



- Extend the transmission distance up to 60m/200ft from the sources at 1280x1024
- Extend the transmission distance up to 30m/100ft from the sources at 1920x1200
- Direct-plug TX and wall mounted RX
- Supports up to 1080i/1080p video and VESA standards up to WUXGA
- Receiving unit can learn EDID information for DVI/HDMI enable display device
- Minimize the cable skew by adjustable equalization with 8 levels
- HDTV resolution & VESA standards are supported

# 3G/HD/SD/HDMI Pattern Generator

## PESA Part No. PRO-3GPG



The PRO-3GPG is an advanced 3G/HD-SDI pattern generator with multi-format (HD/SD) and multi-pattern support. In addition to still and moving video test patterns, other features such as VANC (SMPTE-334M) are provided. With a small portable size, the PRO-3GPG is equipped with four buttons and LCD screen for quick review of the controls screens. This device provides a cost effective way to calibrate and test 3G/ HD-SDI video devices and displays.

Technical	
SDI Standards	SD-SDI, HD-SDI, 3G-SDI
Auto Standards Detection	Yes
Supported Protocols	SMPTE 259M (270Mbps, 360Mbps) DVB ASI (270Mbps) SMPTE 292 (1.485Gbps / 1.485/1.001Gbps) SMPTE 424M (2.97Gbps)
Video Support	1080p50/59.94/60 (4:2:2) 1080p24/25/30 (4:4:4) 1080i50/59.94/60 (4:4:4) 720p24/25/50/59.94/60 (4:4:4) 720p50/59.94/60, 1035i50/59.94/60,1080i50/59.94/60 1080p24/30 SD at NTSC 59.94Hz / PAL 50Hz
Output Signal Type	SMPTE 259M, 292M, 424M, 425M, ASI
Input Signal Type	HDMI (DVI with adapter)
Impedance	75 Ohm
Audio Mode	Tone
Cable Equalization	60m (200ft) for 3G-SDI 150m (500ft) for HD-SDI 300m (1000ft) for SDI
Loop Out	2 Equalized and reclocked
Output Connectors	2X – BNC
Input Connector	1X - HDMI
BNC type	75Ohm
HDMI connector	Type A (19 pin female)
Dimensions	6.3" X 4.3" X .08" (160mm X 110mm X 20mm)
Power Supply	5V 4A DC
Power Consumption	10 W (max)
Operating Temperature	0-40C (32-104F)
Storage Temperature	-20 to 60C (-4 to 140F)
Relative Humidity	20 to 90% (non condensation)
Package Content	1X – Module 1X – User Manual 1X – 5V 4A power adapter

### FEATURES

#### Supported output resolution

NTSC 525@60, PAL 625@50, 720p@23.98, 720p@24,  
720p@25, 720@29.94, 720p@30, 720p@50,720p@59.94,  
720p@60, 1080i@50, 1080i@59.94, 1080i@60,  
1080p@23.97, 1080p@24, 1080p@25,  
1080p@29.97, 1080p@30

**Bit Rate:** 1.485 Gb/s, 1.4835 Gb/s, 270Mb/s

**Resolution:** 10bit

#### Video Patterns

100% Color Bars, Borderline, Random Noise, Check Field, Black, Vertical Lines, Black / White alternate fields, Full Grey / Full White, Black to White Gradient, Random Generator for all still patterns, moving squares White noise, Inverse effect with still pattern, Scrolling Title

#### Save Settings to Memory Option

**ANC Data** EDH (RP-165), SMPTE 352M, SMPTE 334M, SMPTE-12M

**Control** Liquid Crystal Display (LCD) & Panel Buttons

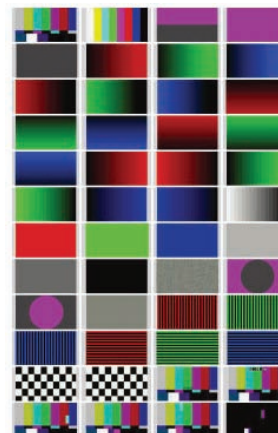

VIDEO PATTERNS



## ORDERING INFORMATION

### USA Corporate Headquarters

PESA  
103 Quality Circle, Suite 210  
Huntsville, Alabama 35806  
TEL: +1 256-726-9200  
FAX: +1 256-726-9271  
sales@pesa.com

### Warranty:

Products manufactured by PESA are manufactured for performance and reliability. PESA warrants these products against defects and workmanship for a period of one year.

### Services:

Customer service support is available 24 hours a day, 7 days a week by calling 1-800-323-7372.  
International customers call +1 (256) 726-9222.

In addition to our Customer service support center, we offer extended warranties and online technical resources via our website at:  
[www.pesa.com](http://www.pesa.com)

On site or factory training is available for control system operations, technical, and maintenance training. Contact our technical support group for additional information.

Spares can be ordered through your area sales representative.  
Specifications subject to change without notice.