

Broadcast Technologies . . . Redefined!™

plura®

SFP-3G Series

The Most Adaptable & Flexible Broadcast Monitor Ever!

17" 21" 24" 32"



PLURA SFP-3G Series - Product Highlights:

New Plura SFP-217-3G, SFP-221-3G, SFP-224-3G & SFP-233-3G, 17", 21", 24" & 32" FULL HD 1920x1080 Precision Broadcast LCD Series is built with 17", 21", 24", 32" high quality panel respectively. The SFP-3G series adapt to various PLURA SFP modules which can fit any possible broadcast application. It supports up to 3 Gbps – 1080-60P along with all other Digital & Analog inputs & formats. The SFP-3G series is capable of converting the SD/HD/3G input to HDMI output.

6x6 Cross Point solution

SFP-3G series comes standard with Built-IN 6x6 Cross Point solution. This allows Plura SFP-3G monitor to be utilized at the front, middle or backend of your video system. The monitor has four SFP cages which can accept variety of Plura SFP modules.

LKFS Audio Loudness Real-Time Monitoring & Logging including other powerful Audio Features

- Digital Loudness Audio Monitoring & Logging with selected channel measurement in LKFS / LUFS scale
- Stereo Analog & 16 CH Embedded Digital Audio Input Support.
- Advanced and various 16 CH Audio Metering Scales.
- Built -IN Stereo 2 W Speakers.
- De-embedding Audio, Stereo Analog Audio & 16 CH Embedded Digital Audio Input Support.

Closed Captioning (708/608)

SFP monitor can decode closed caption streams with 708 Service 1, Service2, 608 Transcoded CC1,2,3&4, 608 line 21, & 608 ANC. SFP monitor can support Teletext 801 & Subtitle OP-47 for Australia & New Zealand region.

* LKFS Monitoring Option - Factory FIT ONLY

Various SFP Modules

SFP-3G series adapts to various SFP Plura modules, such as:

- Fiber Dual TX, RX, Transceiver modules
- Coaxial Dual TX,RX, Transceiver modules
- Hybrid Coaxial & Fiber TX & RX modules
- 3G/HD/SD to HDMI module

"3" Programmable Presets & other Prominent Features

- 3 preset programmable functions
- Line Mode, Skin tone, Range error, Focus Assist.
- Color Temperature – User, VAR, Adjustable (11000K TO 3200K)
- Internal Monitor Display (IMD)
- Pixel to Pixel Mode, Tally, DC Operation
- Display LTC & DVITC time code with line select
- Internal Pattern Generator Digital Audio Decoding
- Picture and Picture (PaP), Picture in Picture (PiP) Display / Blend
- RJ-45 Ethernet, 100Mbps, LAN to Serial supported for wall control applications along with programmable GPI & RS232 Remote Control

Please note that the technical details shown here are provisional specifications (as of July 2015). The Information is subject to change without notice.

www.PluraSFP.com

SFP-3G Powerful I/O Configuration

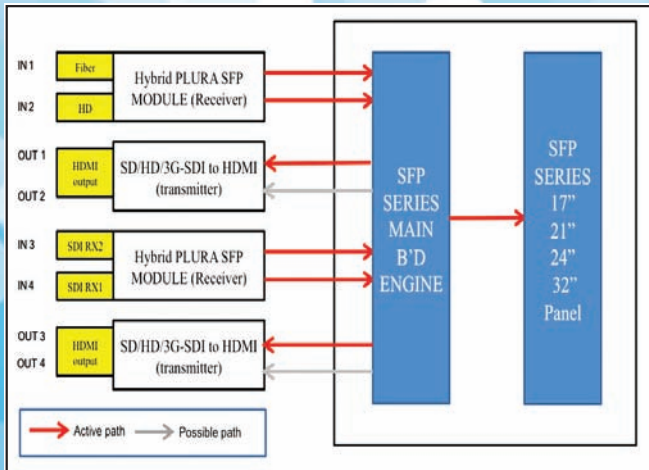

SFP-3G is equipped with powerful video processor to display concurrently two video inputs with the related Waveform & Vector, 16CH Audio Level Metering, and Timecode. Display Advanced Waveform & Vector Scope simultaneously with line select. Very slim chassis – Great for trucks, limited space and other general applications. 17", 21", 24" & 32" sizes all in Full HD panel. RJ-45 Ethernet, 100Mbps, LAN to Serial supported for wall control applications along with programmable GPI & RS232 Remote Control.



Dual Display Mode with Waveform & Vector

Powerful Audio Measurement Package



LKFS Audio Loudness Mode.

LKFS Audio Loudness Measurement - Digital Loudness Audio Metering with selected channel measurement in LKFS scale.

6x 6 Cross Point Switcher

SFP-3G Series comes standard with Built-IN 6 x 6 Cross point solution. This allows the Plura SFP-3G monitor to be utilized at the front, middle or backend of your video system. The monitor has four SFP cages which can accept a variety of Plura SFP modules.

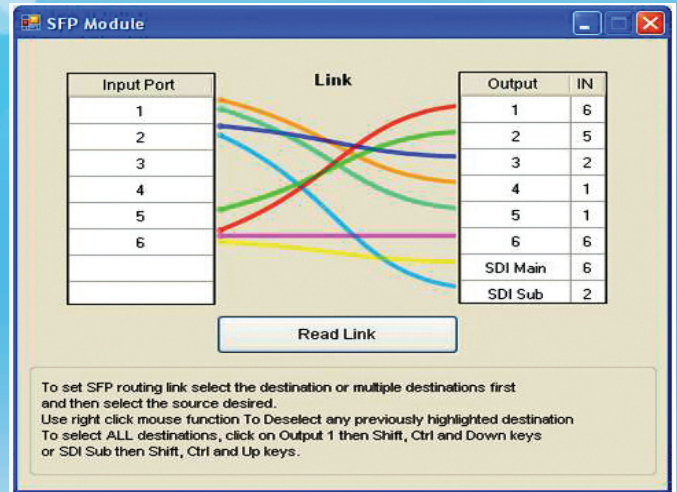

SFP Built-IN 6x6 Cross Point Switcher

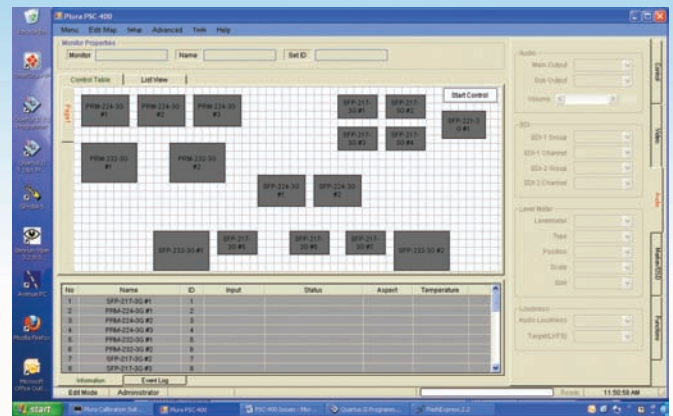

PSC-400 - Plura System Controller
Inclusive Network Controller with Firmware & Cal. File Transfer

- ▶ LKFS Loudness Real - Time Monitoring and Logging
- ▶ Stereo Analog & 16 CH Embedded Digital Audio Input Support.
- ▶ Advanced and various 16 CH Audio Metering Scales
- ▶ Built-IN Stereo 2 W Speakers,
- ▶ De-embedding Audio, Stereo Analog Audio & 16CH Embedded Digital Audio Input support

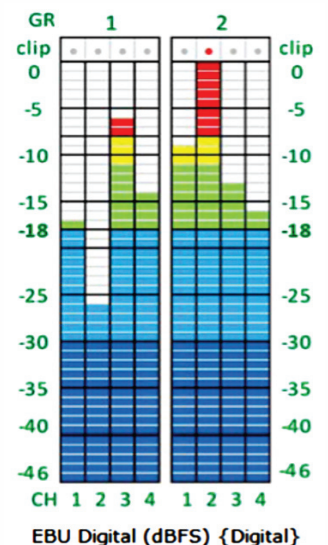

QC Dashboard Capabilities

The NEW Plura QC Dashboard series with the below NEW & Advanced features takes Master Control monitoring to a higher and unmatched Level.

Plura SFP-3G & PRM-3G line up for "QC Dashboard" Series of monitors that include WF/VS, Audio meters, (Closed Caption & V-Chip Decoding) and an on screen LKFS measurement with logging!

SFP-3G monitor series have a built-IN 6x6 router and SFP modular capabilities. This would allow a direct multiple Fiber and/or Coax feeds to the monitor, then you can break out to Coax, Fiber or HDMI. You can also use the HDMI output to go to a larger display.

1 - LKFS Loudness Real-Time Monitoring & Logging

► LKFS Loudness Real-Time display & logging on a remote PC using PSC-500 (Plura System Controller Utility). See below:

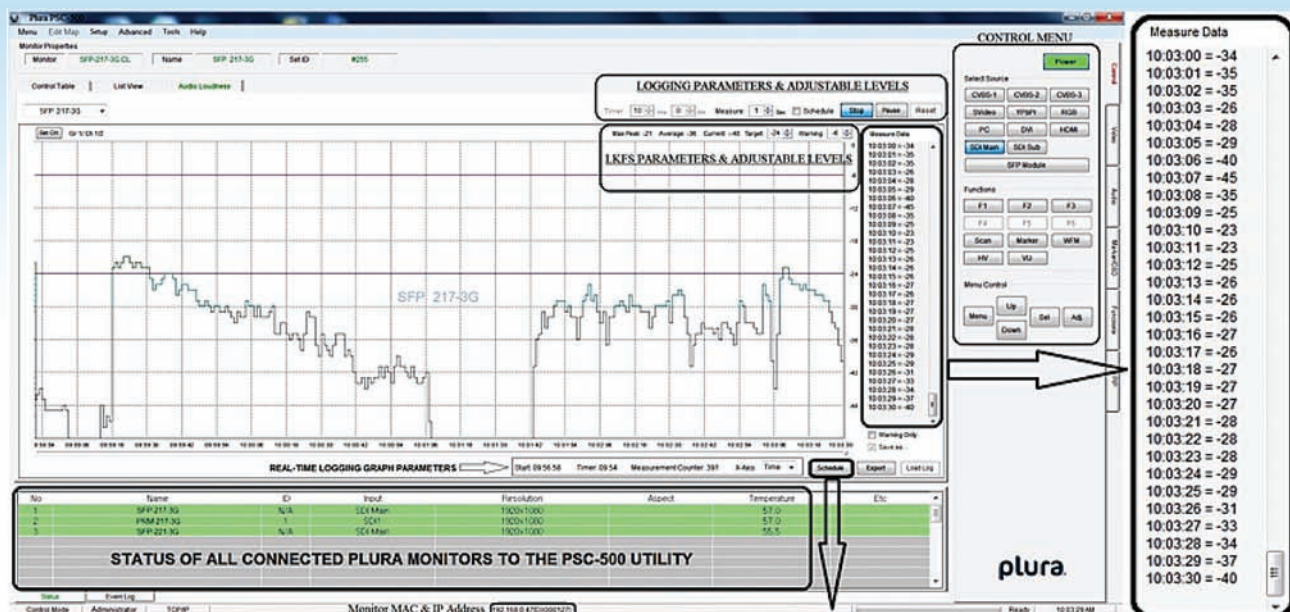

Real-Time logging on a Plura SFP-217-3G Monitor

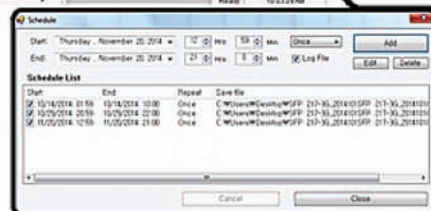

Schedule Menu Edit & Add Unlimited schedule list items.

► LKFS Loudness Real-Time display on the Plura monitor above.

2 - Closed Caption Real-Time display on Plura Monitor



3 - V-Chip decoding Real-Time display on Plura Monitor



4 - HDMI Preview Output – OPTION

This option will allow you to stream real-time video and graphics displayed on the monitor over HDMI signal to any third party screen with HDMI signal. Below:

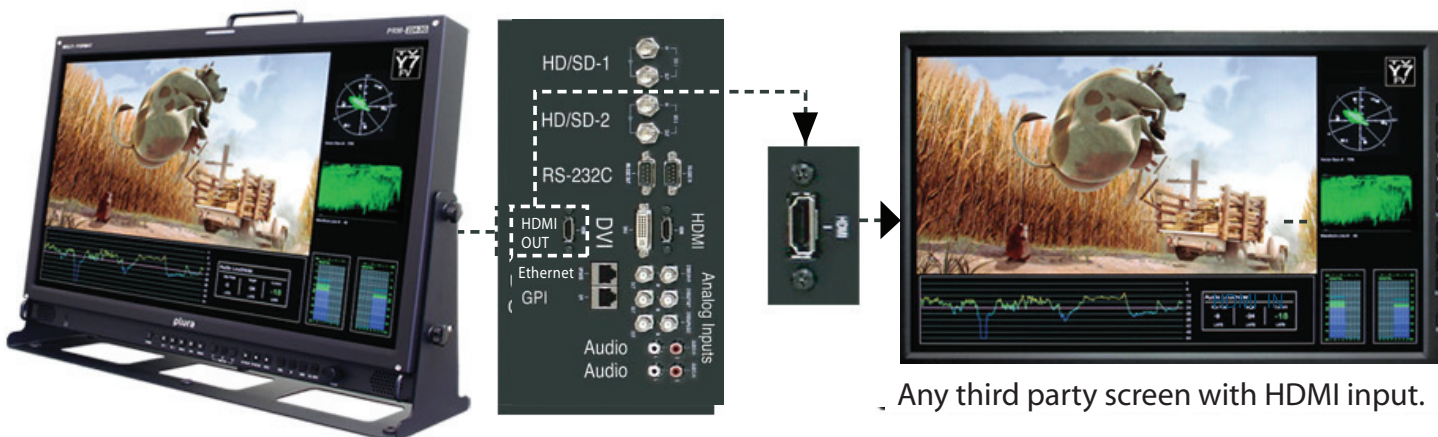

SFP-3G-Series Specifications

FUNCTION		SFP-217-3G	SFP-221-3G	SFP-224-3G	SFP-232-3G	
INPUT	SDI Input	2EA, HD/SD Serial Digital , 3Gb/s, 1.485Gb/s, 270Mb/s, BNC Jack				
	Analog Input	3EA, Composite, Component(YPbPr/RGB), BNC Jack				
	S-VIDEO Input	1EA, YC(S-Video), S-Jack				
	DVI / VGA Input	1EA, DVI-I, 24pin, Female				
	HDMI	1EA, HDMI, 19pin Female				
OUTPUT	SDI Output	2EA, BNC, Active Through Output				
	Analog Loop Output	3EA, 75Ω, BNC Jack (Option)				
ANALOG INPUT FORMAT	Composite	1.0Vpp(with sync)				
	YC (S-Video)	Y :1.0Vp-p, C:0.286Vp-p				
	Component	1.0Vpp (Y with Sync) 0.7Vpp (Pb/Pr)				
	RGB	1.0Vpp (G with Sync), 0.7Vpp (R/B)				
	DVI - (Analog PC)	H Frequency Range : 22~82KHz, V Frequency Range : 55~90Hz, Maximum Resolution : UXGA at 60Hz, Maximum Pixel Rate : 162MHz - Separate Sync Support				
DIGITAL INPUT FORMAT	SMPTE 428.1M	2048x1080P (24/25)				
	SMPTE-425M(3G)	1080p(60/59.94/50/30/29.97/25/24/23.98/30sF/29.97sF25sF/24sF/23.98sF) 1080i (60/59.94/50)				
	SMPTE-260M	1920x1035i(60/59.94)				
	SMPTE-292M	1920x1080i (50/59.94/60) 1920x1080P (30Psf/25Psf/24Psf/30/25/24)				
		Dual Link HD-SDI YPbPr(4:2:2) : 1080P(50/59.94/60) Dual Link HD-SDI YpbPr/RGB(4:4:4)				
	SMPTE 372M	1080P(30/29.97/25/24/23.98) 1080i(29.97/25/24/23.98) 720P(60/59.94/50)				
	SMPTE 296M	1280x720P (50/59.94/60)				
	SMPTE 259M/C	480i(59.94) 576i(50)				
	Component	640 X 480 up to 1920 X 1080p				
	HDMI	H Frequency Range : 22~82KHz, V Frequency Range : 55~90Hz,				
	DVI Digital	Maximum Resolution : UXGA at 60Hz , Maximum Pixel Rate : 162MHz				
	AUDIO INPUT	Input Line	Analog Stereo (RCA Jack)			
		SDI Audio Input	Embedded HD/SD-SDI Audio			
	AUDIO OUTPUT	Speaker Output	1EA, L/R, Stereo pin jack			
		Output Line	2EA, 2W+2W			
Ear-phone Output		1EA, L/R Stereo, 3.5mm pin jack				
I/O PORT	Output Signal	Input Line & De-embedded Audio, 1~ 16CH				
	GPI	1EA, Remote, RJ-45P Jack, GPI-7 Port				
	RS422/485	2EA, RJ-11P Jack, RS-422, Serial interface				
	Ethernet Port	RJ-45 8 pin Ethernet port, 100Mbps, LAN to Serial supported for wall control applications				
	Upgrade Port	D-sub 9 pin female for software upgrade				
LCD	Size	LCD 17"	LCD 21"	LCD 24"	LCD 32"	
	Aspect Ratio	16 : 9	16 : 9	16 : 10	16 : 9	
	Resolution	1920 x 1080	1920 x 1080	1920 x 1200	1920 x 1080	
	Color	16.7 M colors			1,073,741,824 colors	
	Viewing Angle (deg)	H: 160 - V: 160 (typ)		Horizontal: 178(Typ.), Vertical 178 (Typ.)		
	Luminance of White	Max 450 cd/m2	Max 350 cd/m2	Max 400 cd/m2	Max 450 cd/m2	
	Contrast	900 : 1 (Typical)	1000 : 1 (Typical)	1000 : 1 (Typical)	1500 : 1 (Typical)	
	Display Area (H X V)	372.9 x 209.7 (mm)	495.6 x 305.2 (mm)	518.4 x 324.0 (mm)	698.4 x 392.85 (mm)	
	Response Time	Tr=8ms / Tf=8ms	Tr=6ms / Tf=6ms	Tr=7.5ms / Tf=7.5ms	Tr=8ms / Tf=6ms	
	POWER REQUIREMENT	AC 100V ~ 240 V (60/50 Hz)				
POWER CONSUMPTION	0.65A - 0.34A (65W)	1.0A - 0.5A (100W)	1.0A - 0.5A (100W)	1.4A - 0.6A (140W)		
WORKING TEMPERATURE	0°C ~ 40°C (32°~104°F)					
WORKING HUMIDITY	10%RH ~ 85%RH (Non Condensed)					
STORAGE TEMPERATURE	-10°C ~ 80°C (14°~176°F)					
STORAGE HUMIDITY	12 Kg - 26.46 Lbs 10%RH ~ 85%RH (Non Condensed)					
WEIGHT (w/o Stand & Packaging)	7 Kg - 15.43 Lbs	12 Kg - 26.46 Lbs	16 Kg - 35.275 Lbs	30 Kg - 66.2 Lbs		
DIMENSION (WxHxD) (w/o Stand & Box)	445 x 263 x 67mm 17.5 x 10.35 x 2.63 Inch	509 x 323 x 67 mm 20 x 12.7 x 2.63 Inch	553.8 x 382.8 x 93.2 mm 21.8 x 15.1 x 3.7 Inch	787 x 485 x 98.5 mm 31 x 19.1 x 3.9 Inch		
PACKAGING DIMENSION (WxHxD)	550 x 435 x 220 mm 21.7 x 17.2 x 8.7 Inch	660 x 523 x 220 mm 26 x 20.6 x 8.7 Inch	660 x 523 x 220 mm 26 x 20.6 x 8.7 Inch	932 x 630 x 272 mm 36.69 x 24.8 x 10.7 Inch		
ACCESSORY	Power Cord - Desk Stand					
OPTION	Rack Mount - Vertical/Wall Mount - Carring Case					

Please note that the technical details shown here are provisional specifications (as of July, 2015). This information is subject to change without notice.

Plura SFP- 3G /Small Form Factor Pluggable Modules

The powerful I/O configuration design of any SFP-3G monitor is based on the popular SFP- (small form factor pluggable) modules. Every SFP-3G monitor comes with four slots and can be populated in many way, shape & form as per drawings below with many different modules types you can select from to fit your application. This makes the SFP-3G monitor series the most adaptable and flexible broadcast monitor ever!



Four SFP cages can accept variety of Plura SFP modules.
SFP -1 SFP -2 SFP -3 SFP -4



Sample: 3 Gbps SDI Dual Optical Transmitter (1310nm) Module

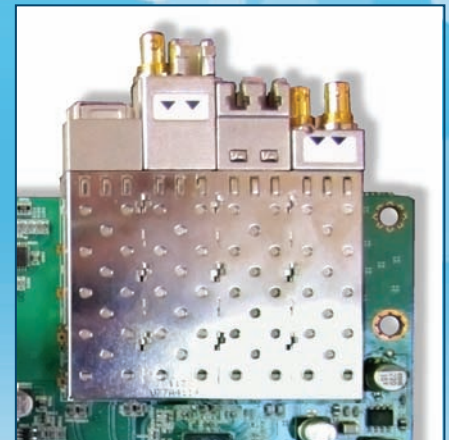

SFP MODULE IN /OUT

SFP 1 (DUAL MODE)		SFP 2 (DUAL MODE)		SFP 3 (DUAL MODE)		SFP 4 (DUAL MODE)					
IN 1	IN 2	OUT 1	IN 3	IN 4	OUT 2	OUT 3	OUT 4	IN 5	OUT 5	OUT 6	IN 6

Plura Module Model #	Description
SFP-3G-2RX-1310F-LC-MH	SFP Module - 3Gbps SDI Dual Optical Receiver (1310nm) - LC-F
SFP-3G-2RX-HD-BF-LR	SFP Module - 3Gbps SDI Dual Coaxial Receiver, HDBNC
SFP-3G-2RX-HD-BF-LR-C	SFP Module - 3Gbps SDI Dual Coaxial Receiver, w/Reclocker, HDBNC
SFP-3G-2TX-1310F-LC-MH	SFP Module - 3Gbps SDI Dual Optical Transmitter, (1310nm) - LC-F
SFP-3G-2TX-HD-BF-LR	SFP Module - 3Gbps SDI Dual Coaxial Transmitter, HDBNC
SFP-3G-2TX-HD-BF-LR-C	SFP Module - 3Gbps SDI Dual Coaxial Transmitter, w/Reclocker, HDBNC
SFP-3G-TX-HDMI-F-TYPE D	SFP Module - 3Gbps SDI to HDMI converter, Type D
SFP-3G-TXRX-1310F-LC-MH	SFP Module - 3Gbps SDI Optical Transceiver, (1310nm) - LC-F
SFP-3G-TXRX-HD-BF-LR	SFP Module - 3Gbps SDI Coaxial Transceiver, HDBNC
SFP-3G-TXRX-HD-BF-LR-C	SFP Module - 3Gbps SDI Coaxial Transceiver, w/Reclocker, HDBNC

Software Packages	
SFP-LKFS	LKFS monitoring Option - Factory FIT ONLY
PSC-400	Plura Software System Controller for SFP, PRM, LCM & PBM Series
PSC-500	Plura LKFS System Logger Package for SFP & PRM Series



Front view of SFP -217-3G

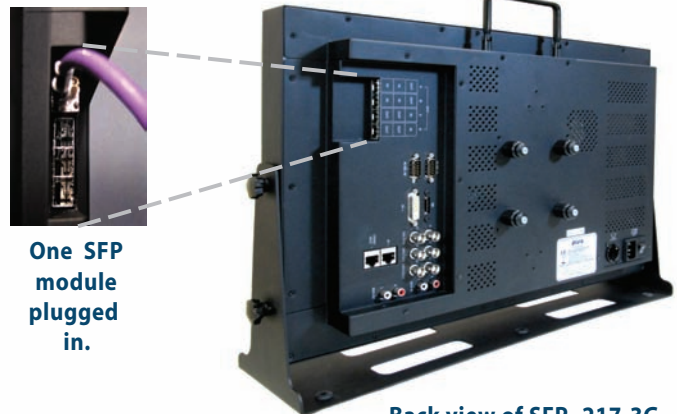

Back view of SFP -217-3G

One SFP module plugged in.



PRC-400 - 1 RU Universal Control Panel

www.PluraSFP.com