



SpeechLine Wired MAT 133, MAT 133-S, MAT 153-S - Tablestand

**MAT 133****MAT 133-S****MAT 153-S**

FEATURES

- Timeless Design
- Bi-color light ring for clear visual feedback
- Switchable microphone modes
- Logic port for seamless integration
- Made in Germany

The MAT 133 is a rugged and unobtrusively designed tablestand. It provides a solid ground for XLR3 gooseneck microphones.

The MAT 133-S provides a convenient microphone button that is featured with a bi-color light ring for clear visual feedback. The TTL-logic output serves for various control purposes such as camera control. The MAT 133-S is as versatile as it is easy to operate.

The MAT 153-S provides solid ground for XLR-5 gooseneck microphones.

ARCHITECT'S SPECIFICATION

The tablestand for connecting and operating XLR gooseneck microphones shall be rugged and unobtrusive. It shall feature an XLR-3F microphone input and an XLR-3M microphone output. The tablestand shall operate on 48 V phantom power. Current consumption shall be 1.9 mA. Dimensions shall be 120 x 170 x 43 mm (4.72" x 6.69" x 1.69"). Weight shall be 1,210 grams (42,68 oz). Operating temperature shall range from -10 °C to +50 °C (+14 °F to +122 °F). The tablestand shall be the Sennheiser MAT 133.

The Sennheiser MAT 133 shall also be available as a variant (-S) with a programmable microphone button (Toggle on/off, PTM, PTT and permanent on) and a bi-color LED ring for status indication. The current consumption of the -S version shall be 3.7 mA. The tablestand shall provide a TTL logic connector with logic inputs and outputs. The logic output voltage shall be high level > 2.4 and low level < 0.4 V, the logic input voltage shall be high level > 2.0 V and low level < 0.8 V.







The tablestand for connecting and operating XLR gooseneck microphones shall be rugged and unobtrusive. It shall have a programmable microphone button (Toggle on/off, PTM, PTT and permanent on) and a bi-color LED ring for status indication shall be provided. The tablestand shall feature an XLR-5F microphone input, an XLR-5M microphone output and a TTL logic connector with logic inputs and outputs. The logic output voltage shall be high level > 2.4 and low level < 0.4 V, the logic input voltage shall be high level > 2.0 V and low level < 0.8 V. The tablestand shall operate on 48 V phantom power. Current consumption shall be 3.7 mA. Dimensions shall be 120 x 170 x 43 mm (4.72" x 6.69" x 1.69"). Weight shall be 1,210 grams (42,68 oz). Operating temperature shall range from -10 °C to +50 °C (+14 °F to +122 °F). The tablestand shall be the Sennheiser MAT 153-S.



SpeechLine Wired

MAT 133, MAT 133-S, MAT 153-S - Tablestand

SPECIFICATIONS

	MAT 133	MAT 133-S	MAT 153-S
Phantom power	P 24		
Current consumption	1.9 mA	3.7 mA	3.7 mA
Connectors	Mic In - XLR-3F Mic Out - XLR-3M	Mic In - XLR-3F Mic Out - XLR-3M	Mic In - XLR-5F Mic Out - XLR-3M
Pin assignment out	XLR-3M out 1 = gnd 2 = Audio + 3 = Audio -	XLR-3M out 1 = gnd 2 = Audio + 3 = Audio -	XLR-3M out 1 = gnd 2 = Audio + 3 = Audio -
Pin assignment in	XLR-3F in 1 = gnd 2 = Audio (+) 3 = Audio (-)	XLR-3F in 1 = gnd 2 = Audio (+) 3 = Audio (-)	XLR-5F in 1 = gnd 2 = Audio (+) 3 = Audio (-) 4 = LED 5 = LED (+)
LED light ring color		red/green	red/green
Microphone modes		Toggle on / off Push to mute Push to talk permanent on	Toggle on / off Push to mute Push to talk permanent on
Connection		clip contact for logic	clip contact for logic
Pin assignment logic connector		trigger signal at the logic connector:  Logic in (external LED control)  GND  Logic out (switch signal)	trigger signal at the logic connector:  Logic in (external LED control)  GND  Logic out (switch signal)
Weight	1,210 g	1,210 g	1,210 g
Dimensions (W x D x H)	120 x 170 x 43 mm (4.72" x 6.69" x 1.69")	120 x 170 x 43 mm (4.72" x 6.69" x 1.69")	120 x 170 x 43 mm (4.72" x 6.69" x 1.69")
Operating temperature	-10 °C to +50 °C (+14 °F to +122 °F)	-10 °C to +50 °C (+14 °F to +122 °F)	-10 °C to +50 °C (+14 °F to +122 °F)

DELIVERY INCLUDES

- Tablestand
- Quick guide
- Safety guide



SpeechLine Wired

MAT 133, MAT 133-S, MAT 153-S - Tablestand

DIMENSIONS

MAT 133

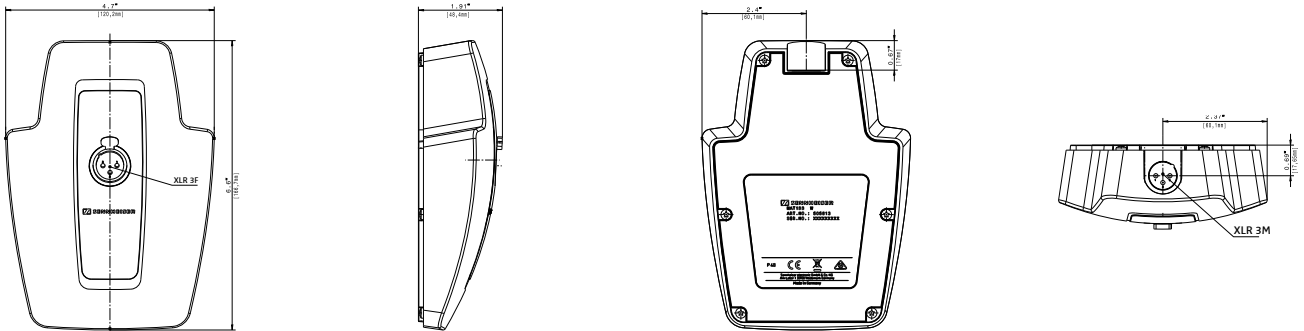

MAT 133-S

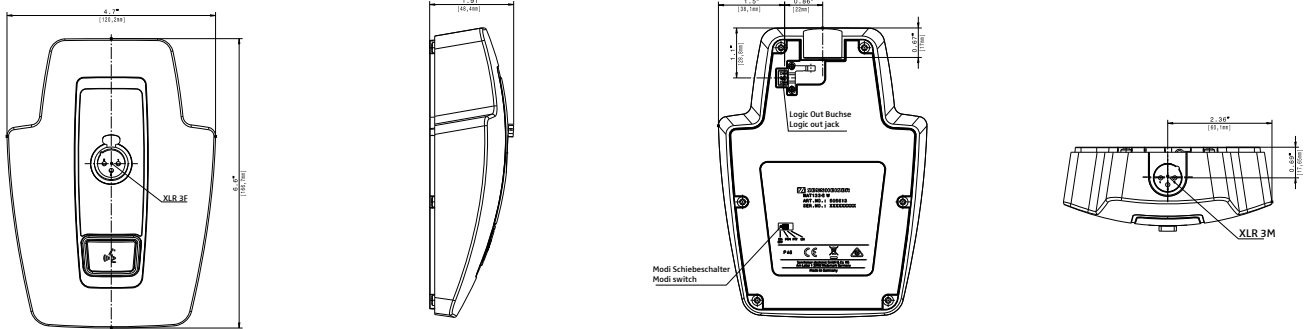

MAT 153-S

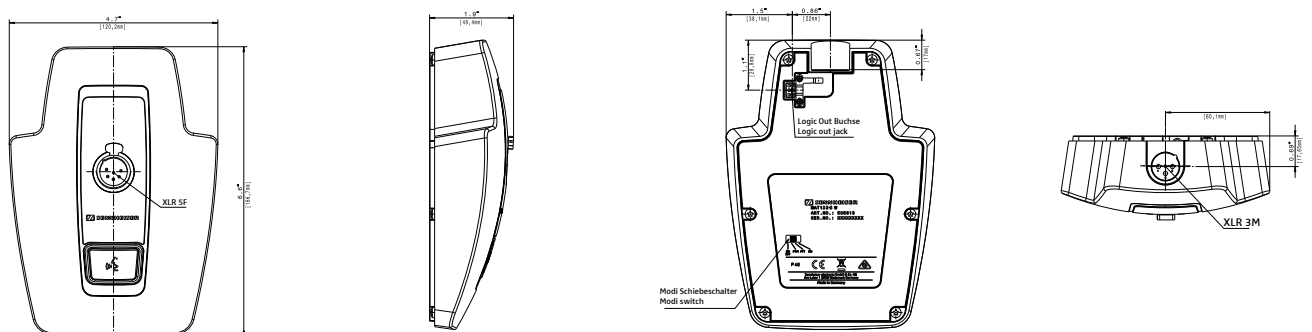

ACCESSORIES

MEG 14-40 B gooseneck microphone	Art. No. 504791
MZH 3015 gooseneck	Art. No. 005074
MZH 3015-L gooseneck	Art. No. 009435
MZH 3040 gooseneck	Art. No. 005076
MZH 3040-L gooseneck	Art. No. 009436
ME 34 microphone capsule	Art. No. 005060
ME 35 microphone capsule	Art. No. 005063
ME 36 microphone capsule	Art. No. 005065

PRODUCT VARIANTS

MAT 133 B, black	Art. No. 505622
MAT 133-S B, black	Art. No. 505624
MAT 153-S B, black	Art. No. 505626